



Product: [VBD 1A-1-2-226](#)

VBD DIN Standard Single-Ended Cordset: Form B, 3-pin (2+1PE; PE across cable outlet), translucent body, with varistor and yellow LED, 24 V AC/DC, 4 A; PUR black cable, 0.50 mm²

Product Description

VBD DIN Standard Single-Ended Cordset: Form B, 3-pin (2+1PE; PE across cable outlet), translucent body, with varistor and yellow LED, 24 V AC/DC, 4 A; PUR black cable, 0.50 mm²

Technical Drawing

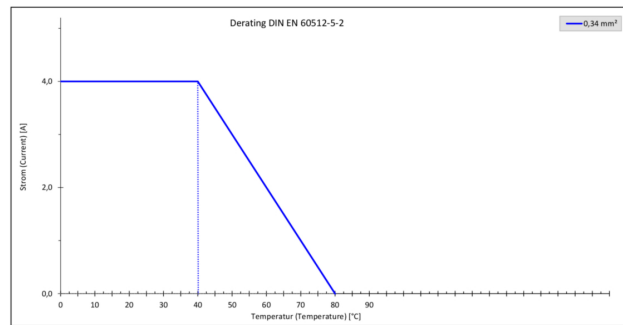
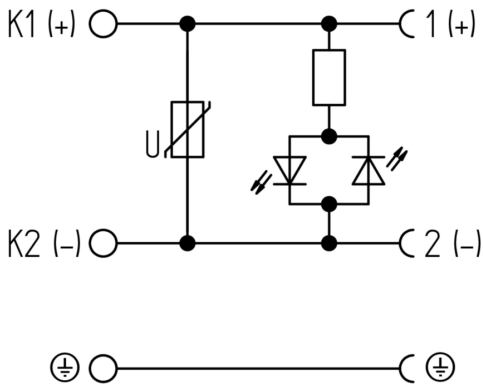
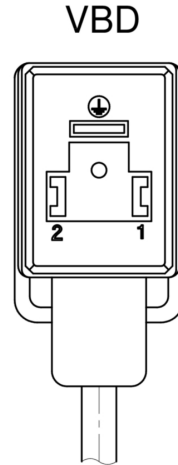
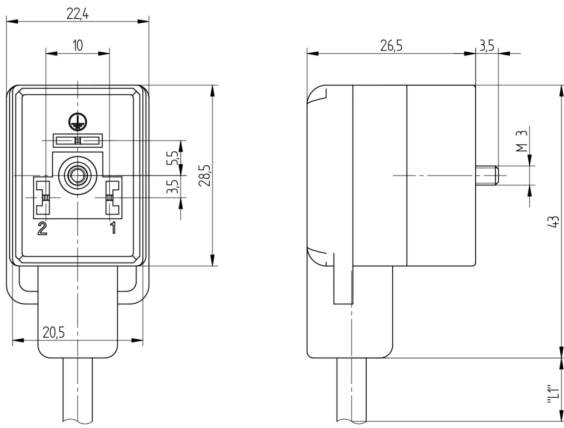

Technical Specifications

Face View

Pin 1	Pin 2	PE
brown	blue	green-yellow

Technical Data

Product Family:	Valve Connectors
-----------------	------------------

Product Sub Family:	VBD DIN Standard
Brand:	Hirschmann
Connector Type:	Cordset, single ended
Type of Contact / Gender:	Female
Connector Design:	Angled
Number of Pins:	2+PE (PE across cable outlet)
Coding:	B
Shielding:	Unshielded
Attachment Type:	Central Screw
Rated Voltage:	30 V AC/DC
Rated Impulse Voltage:	4.0 kV (PCBA 2.0 kV)
Operating Voltage:	24 V AC/DC
Rated Current*:	4 A
Contact Resistance:	≤ 10 mOhm
Insulation Resistance:	> 10 ⁹ Ohm
Mating Cycles:	≤ 50
Ambient Temperature (Operation)*:	-25 °C - +80 °C
Protection Degree / IP Rating**:	IP65
Design Standard:	DIN EN 175301-803-B, ISO 4400
Pollution Degree:	3 acc. to DIN EN 60664-1 (VDE 0110-1)
Clearance / Creepage Distance:	DIN EN 60664-1 (2008/01); VDE 0110-1
Overvoltage Category:	III acc. to DIN EN 60664-1 (VDE 0110-1)

Materials

Contact Base Material:	CuZn
Contact Plating:	Cu/Sn
Contact Bearer Material:	PA GF
Contact Bearer Color:	black
Flammability Class (Contact Bearer):	UL 94 V-0
Molded Body Material:	TPE
Molded Body Color:	Translucent
Flammability Class (Molded Body):	UL 94 HB
Attachment Material:	Steel, Philips combi slot

Protection Circuitry

Function Indicator:	Yellow LED
Protective Circuit:	Varistor

Additional Technical Data

Fastening Torque (Attachment):	(50-60) Ncm
--------------------------------	-------------

Cable Data

Cable Number:	226
Conductor Size:	0.5 mm ²
Number of Wires:	3
Minimal Bending Radius (Fixed Inst):	> 5 x D
Minimal Bending Radius (Flexible Inst):	> 10 x D
Cycles (Bending):	> 5 M
Cycles (Torsion):	> 5 M @ ± 360 °/1 m
Conductor material:	Cu
Cable Jacket Material:	PUR
Cable Jacket Color:	black
Cable Diameter D:	ø 4.6 ± 0.20 mm
Wire Insulation Material:	PP
Insulated Wire Diameter:	ø 1.50 mm
Ambient Temperature (Fixed Installation):	- 50 °C - + 105 °C (UL: + 80 °C)
Ambient Temperature (Flex Installation):	- 25 °C - + 105 °C (UL: + 80 °C)

Ambient Temperature (Drag Chain Inst):	- 25 °C - + 60 °C
UL Cable Type:	AWM: 20549
Flammability Class (Cable Jacket):	DIN EN 50265-2-2, VDE 0482-265-2-2, IEC 60332-2-2, CSA FT2
Cable Characteristics:	Good microbes and hydrolysis resistance; Mainly plasticizer diffusion free; Exclusion of PVC and silicone; Coldness flexibility; Free of lacquer wetting disturbing substances

Safety & Environmental Compliance

RoHS Compliant:	yes
-----------------	-----

Resistances

Halogenfree:	yes
Oil Resistance:	Good chemical and oil resistance

Notes

Note Derating:	Notice derating
Protection Degree / IP Rating Note:	** only if mounted and locked in combination with Hirschmann / Lumberg Automation connector.
Note:	Do not connect or disconnect under load.

Variants

Item #	Item Description	Cable Length
12236	VBD 1A-1-2-226/2 M	2 m
12237	VBD 1A-1-2-226/5 M	5 m
43897	VBD 1A-1-2-226/10 M	10 m
68216	VBD 1A-1-2-226/25 M	25 m

© 2024 Belden, Inc

All Rights Reserved.

Although Belden makes every reasonable effort to ensure their accuracy at the time of this publication, information and specifications described here in are subject to error or omission and to change without notice, and the listing of such information and specifications does not ensure product availability.

Belden provides the information and specifications herein on an "ASIS" basis, with no representations or warranties, whether express, statutory or implied. In no event will Belden be liable for any damages (including consequential, indirect, incidental, special, punitive, or exemplary damages) whatsoever, even if Belden has been advised of the possibility of such damages, whether in an action under contract, negligence or any other theory, arising out of or in connection with the use, or inability to use, the information or specifications described herein.

All sales of Belden products are subject to Belden's standard terms and conditions of sale.

Belden believes this product to be in compliance with all applicable environmental programs as listed in the data sheet. The information provided is correct to the best of Belden's knowledge, information and belief at the date of its publication. This information is designed only as a general guide for the safe handling, storage, and any other operation of the product itself or the one that it becomes a part of. The Product Disclosure is not to be considered a warranty or quality specification. Regulatory information is for guidance purposes only. Product users are responsible for determining the applicability of legislation and regulations based on their individual usage of the product.