



Product: [RSW 30-838](#)

7/8" Power Single-Ended Cordset: Male, angled, 3-pin, yellow body, 600 V (UL), 10 A (UL); TPE yellow cable, 16 AWG

Product Description

RSW 30-838 - 7/8" Power Single-Ended Cordset: Male, angled, 3-pin, yellow body, 600 V (UL), 10 A (UL); TPE yellow cable, 16 AWG

Technical Drawing

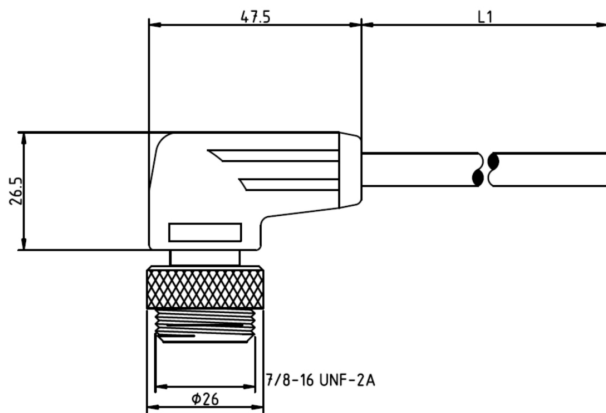

FACE VIEW MALE



1 = GN
2 = BK
3 = WH

Technical Specifications

Technical Data

Product Family:	Power Connector
Product Sub Family:	7/8"
Brand:	Lumberg Automation
Connector Type:	Cordset, single ended
Type of Contact / Gender:	Male
Connector Design:	angled
Number of Pins:	3
Coding:	A
Shielding:	Unshielded
Attachment Type:	Coupling nut with external threads
Rated Voltage:	600 V
Rated Voltage (UL):	600 V
Rated Current*:	10 A
Rated Current (UL)*:	10

Ambient Temperature (Operation)*:	- 30 °C - + 90 °C
Protection Degree / IP Rating**:	IP65, IP67, NEMA 6P

Materials

Contact Base Material:	CuZn
Contact Plating:	Au over Ag
Contact Bearer Material:	TPU
Contact Bearer Color:	Yellow
Molded Body Material:	TPU
Molded Body Color:	Yellow
Attachment Material:	Al

Cable Data

Cable Number:	838
Conductor Size:	16 AWG (65/34)
Number of Wires:	3
Minimal Bending Radius (Flexible Inst):	> 10 x D
Conductor material:	Stranded, BC
Cable Jacket Material:	TPE
Cable Jacket Color:	Yellow
Cable Diameter D:	Ø 8 mm
Wire Insulation Material:	PVC-Nylon
Insulated Wire Diameter:	Ø 2.5 mm
Ambient Temperature (Fixed Installation):	-30 °C to +90°C
UL Cable Type:	TC-ER (90°C Dry / 75°C Wet) 600 V
Flammability Class (Cable Jacket):	FT4 / IEEC 1202
Cable Characteristics:	Oil and Coolant, Vibration, UV, Abrasion, and Weld Spark resistant, Continuous Flex

Approvals

UL-File:	E104696
UL:	UL recognized

Safety & Environmental Compliance

RoHS Compliant:	Yes
-----------------	-----

Resistances

Oil Resistance:	Oil Res II
-----------------	------------

Notes

Note Derating:	Notice derating
Protection Degree / IP Rating Note:	** only if mounted and locked in combination with Hirschmann / Lumberg Automation connector.

History

Update and Revision:	Revision Number: 0.84 Revision Date: 05-04-2023
----------------------	---

Variants

Item #	Item Description	Cable Length
500004279	RSW 30-838/1M	1 m

© 2024 Belden, Inc

All Rights Reserved.

Although Belden makes every reasonable effort to ensure their accuracy at the time of this publication, information and specifications described here in are subject to error or omission and to change without notice, and the listing of such information and specifications does not ensure product availability.

Belden provides the information and specifications herein on an "ASIS" basis, with no representations or warranties, whether express, statutory or implied. In no event will Belden be liable for any damages (including consequential, indirect, incidental, special, punitive, or exemplary damages) whatsoever, even if Belden has been advised of the possibility of such damages, whether in an action under contract, negligence or any other theory, arising out of or in connection with the use, or inability to use, the information or specifications described herein.

All sales of Belden products are subject to Belden's standard terms and conditions of sale.

Belden believes this product to be in compliance with all applicable environmental programs as listed in the data sheet. The information provided is correct to the best of Belden's knowledge, information and belief at the date of its publication. This information is designed only as a general guide for the safe handling, storage, and any other operation of the product itself or the one that it becomes a part of. The Product Disclosure is not to be considered a warranty or quality specification. Regulatory information is for guidance purposes only. Product users are responsible for determining the applicability of legislation and regulations based on their individual usage of the product.