

User Manual

Installation

MAMMUTHUS Core-layer Switch – **MTS8010-Chassis**

MAMMUTHUS Power Module – **MTM8000-PSU800**

MAMMUTHUS Engine Module – **MTM8000-Engine**

MAMMUTHUS Fan Module – **MTM8010-FAN**

MAMMUTHUS Medium Module – **MTM8000-XXXX**

MAMMUTHUS Blank cover – **MTM8000-XXXXCover**



Even without specific notice, the trademark name protected by copyright in this manual shall not be considered as being free for use by any person from the aspect of protection law for trademark and trade name.

© 2020 Belden Singapore Pte Ltd

Both the manual and software are protected by copyright. All rights reserved. All or any part of this manual shall be prohibited from being reproduced, copied, translated or converted into any electronic media or machine-scannable form, except in the case that you make a copy of the software for your own use.

The performance characteristics described herein shall be binding only upon the express consent of the parties at the time of signing the contract. This paper is produced by Belden within its capacity. Belden reserves the right to change the contents of this manual without prior notice. Belden does not guarantee the correctness or accuracy of the information in this manual.

Belden shall not be liable for damages caused by the use of network components or related operating software. And the conditions of use specified in the license contract are referred to in this manual.

You may access the latest version of this manual at the product website of Hirschmann IT: [Hirschmann-it.support.belden.com](https://hirschmann-it.support.belden.com).

MAMMUTHUS switch

Contents

Safety Guideline	6
About this manual	13
Legend	14
1 Description	15
1.1 General device description	15
1.2 Device name and product code	22
1.2.1 Basic device	22
1.2.2 Power module	22
1.2.3 Engine module	22
1.2.4 Fan module	22
1.2.5 Medium module	23
1.2.6 Blank cover	24
1.3 Device view	25
1.3.1 MTS8010-Chassis	25
1.3.2 Power module	27
1.3.3 Engine module	27
1.3.4 Fan module	28
1.3.5 Medium module	28
1.3.6 Blank cover	29
1.4 Power supply	30
1.5 Device port attribute	31
1.5.1 Console port attribute	31
1.5.2 USB Console port attribute	31
1.5.3 10Base-T/100Base-TX/1000Base-T RJ45 electric interface attribute ..	31
1.5.4 10GBase-T RJ45 electric interface attribute	32
1.5.5 1000Base-X SFP optical interface attribute	32

1.5.6	10GBase-SR/LR/ER SFP+ optical interface attribute.....	32
1.5.7	40GBase-SR4/LR4 QSFP+ optical interface attribute.....	32
1.5.8	USB interface attribute.....	33
1.5.9	SD interface attribute	33
1.5.10	POE interface attribute.....	33
1.6	Display unit	35
1.6.1	Device status	35
1.6.2	Port status.....	36
1.7	Management interface.....	38
1.7.1	DC0 interface (external management)	38
1.7.2	USB interface	38
2	Installation.....	39
2.1	Unpacking and inspection.....	39
2.2	Install the power module (optional).....	39
2.3	Device installation and earthing	40
2.4	Install SFP transceiver (optional).....	42
2.5	Operate the device	44
2.6	Connecting the data cable.....	44
2.7	Fill in the label	44
3	Carry out the basic setting	45
4	Monitor the ambient air temperature	46
5	Repair and maintenance	47
6	Remove	48
6.1	Remove the power module.....	48
6.2	Remove the fan module.....	48
6.3	Remove SFP transceiver	48
6.4	Remove engine or medium module.....	49
6.5	Remove the device	49

7	Technical data	51
7.1	General technical data	51
7.2	Dimensional Drawing	53
7.3	EMC and interference immunity.....	56
7.4	Network range	59
7.5	Power consumption/power output.....	59
8	Delivery item, order number and accessories	60
9	Basic technical criteria	62
A	More support	64

Safety Guideline

Warning

Uncontrolled machine action

To avoid uncontrolled machine action due to data loss, configure all data transfer devices separately.

Before starting any machine controlled by data transfer, be sure to complete the configuration of all data transfer devices.

Failure to comply with these guidelines may result in death, serious injury or equipment damage.

General Safety Guideline

This device shall be operated with electricity. Improper use of the device will result in personal injury or significant property loss. Whether this device can be properly and safely operated depends on whether the handling process is proper, whether the storage and installation operation are reasonable, and whether the operation and maintenance procedures are firmly developed and strictly observed.

Before connecting any cable, read this article, safety guideline and warning.

Only operate the device without any damaged component.

Confirm that there is no component to be repaired in the device. In case of the device damage or fault, it is required to cut off the power supply and return the device to Belden for inspection.

Qualification requirements for the operators

Only the qualified person can operate this device.

The qualified personnel shall have the following features:

The qualified personnel shall receive proper training. Training and related practical knowledge and experience is the prerequisite for obtaining the product operation qualification. Only when these prerequisites are met, can the operator implement the earthing and labeling on the circuit, device and system according to the current safety technical standard.

The qualified personnel shall know the danger in their work.

The qualified personnel shall be familiar with how to handle these

hazards, so as to reduce the risks on themselves and other persons.

The qualified personnel shall receive regular training.

Correct use

The device is only used for the intended use in the catalog and technical description. It is only allowed to use external units and components as recommended and allowed by the manufacturer, to operate the device. Correct and safe operation of this product depends on correct operation, storage, assembly and installation during the transportation, as well as careful operation and maintenance procedures.

National and international safety regulations

Carry out the verification, to ensure that electrical installation complies with the local or national safety regulations.

Requirements for the connection of electric wire

Before connecting the electric wire, make sure to **always** confirm compliance with all listed requirements.

The following requirements apply, and no limitation is set:

The electric wire is voltage-free.

All cables meet the requirements for temperature range in specific application.

First, before setting other connections, connect the earthing screw on the back of the device with the protective conductor. During the dismantling of the connection, the protective conductor shall be finally dismantled.

During the installation, do not supply electricity to the device.

Related requirements in North American region:

Only use 60/75°C (140/167°F) or 75°C (167 °F) copper (Cu) wire.

Table 1: Requirements for the connection of electric wire

Requirements for connection of power voltage

Device model	Prerequisite:
All models	Comply with all of the following requirements: <ul style="list-style-type: none">The power voltage shall be consistent with the voltage specified on the device nameplate.The power supply conforms to overvoltage category I or II.The power supply is equipped with the easily operable shutoff devices (such as switch or plug).<ul style="list-style-type: none">This shutoff device has the clear mark. In case of emergency, the operator will be easy to know the shutoff device which corresponds to the related power cable.When connecting the power voltage with the protective conductor: firstly, connect the protective conductor, then connect the power voltage.If the device contains the second voltage connecting module of this category: firstly, connect the protective conductor, then connect the power voltage.DC voltage is used for power supply:<ul style="list-style-type: none">The diameter of the power line in the voltage input end of the power supply must be at least 1mm² (North America: AWG16).AC voltage is used for power supply:

The diameter of the power line in the voltage input end of the power supply must be at least 0.75 mm² (North America: AWG18).

The cross section area of the earthing conductor is equal to or more than the cross section area of the power line.

The power cable applicable for voltage, current and physical load shall be used.

The external fuse is installed in the conductor other than on the ground location.

Table 2: Requirements for connection of power voltage

⚠ Special conditions for safe use

Measures will be taken to prevent the instantaneous interference exceeding 140% of the rated voltage in the voltage input end.

Shielded earthing

The shielded earthing module of the twisted-pair cables is used as the conductor for connection to the front panel.

When connecting the cable segment with the conductive shielding braided layer, attention shall be paid to the possible short-circuiting.

ESD guideline

These modules are equipped with the electrostatic sensitive components.

In case that the connection is touched, these sensitive components are damaged or their service life is shortened due to the electric field or load balance effect.

You may check the information on the components with electrostatic danger in DIN EN 61340-5-1 (2007-08) and DIN EN 61340-5-2 (2007-08).

Device enclosure

Only the technician authorized by the manufacturer can be allowed to open the enclosure.

- Keep the air vent unblocked, to ensure good air circulation.
- Ensure that there will be the space of at least 3.94-inch (10cm) in front of the air vent of the enclosure.
- During the operation or shortly after the shutdown of the device, do not touch the enclosure. Hot surface will cause any possible damage. Install the device horizontally in the machine cabinet or vertically on the flat surface.

Do not place the device on the tabletop for operation. Refer to "Device Installation and Earthing" on Page 38.

- Operate the device in the maximum ambient air temperature and stacking device: when installing the device, ensure that there is at least the space available for the machine frame (about 5cm) above the device, to facilitate smooth discharge of heat out of the device enclosure.
- If you operate the device in the 19" switch cabinet: install the slide/install guide rail to support the weight of the device.

Requirements for the installation station

This device can only be operated at the specified ambient temperature-ambient air temperature at 2 inch (5cm) away from the device- and at relative humidity.

- When choosing the installation position, ensure the compliance with climatic threshold as stipulated in the technical data.
- This device is used in the environment that the maximum pollution class conforms to the technical data code.

□ **CE Mark**

The marked devices comply with the regulations in the European Directive:

Device model	Directive
All models	2011/65/EU and 2015/863/EU (RoHS) The directives of European Parliament and the Council on restricting the use of some hazardous substances in the electrical and electronic devices.
All models	2014/30/EU (EMC) The directives of European Parliament and the Council on standardizing the regulations of the member countries regarding electromagnetic compatibility.

Observe the above EU directives and submit of EU Declaration of Conformity to the related institution with the following address:

Hirschmann Automation and Control GmbH
Stuttgarter Str. 45-51
72654 Neckartenzlingen
Germany
www.belden.com

Warning! This is Category A device, which might interfere with the living area. In this case, the operator might be required to take proper measures.

Warning! When Ethernet cable is used in the industrial environment, it must be shielded.

Note: it is required to strictly follow the assembly rules provided in these guidelines, so as to observe the EMC threshold.

□ **LED or laser component**

LED or laser component conforming to IEC 60825-1 (2014):

Category 1 laser product

Category 1 LED product

□ **FCC notes:**

This device conforms to Part 15 of FCC Rules. When operating the device, it is required to meet the following two conditions: (1) this device will not have any harmful interference; (2) this device must accept any received interference, including the interference with the possibility to result in accidental operation. Proper test has proven that the device conforms to the requirements for Category A digital device in FCC Rules Part 15.

These requirements aim to provide sufficient protection, and prevent the device from being disturbed during the use in the commercial environment. This device creates and uses high frequencies, and might radiate these frequencies. If the device is not installed and used according to this operation manual, it might result in the radio transmission interference. If the device is used in the residential area, it might result in interference, and in this case, the user shall be obliged to eliminate the interference at their own cost.

□ **Recycling note**

After the use, you must properly dispose of this device as the electronic waste according to the current disposal regulations in the related county, state and country.

About this manual

This "installation" user manual consists of device description, safety guideline, display description and other information required for device installation.

Legend

The symbols used in this Manual have the following meanings:

• •

Itemized list
Work steps
Subtitle

1 Description

1.1 General device description

MTS8010 switch uses the main control and exchange separation technology leading in the industry. The whole machine can provide the deployment capability of at most 448 10G interfaces or 128 40G high-density ports. Provide multiple physical resource virtualization technologies, such as 1:N, N:1, raise the SDN compatible machine concept for the first time, and realize the integration of SDN deployment with the functions of common switch.

MTS8010 switch can meet the demand for the deployment scenario with high throughput, and high-density and high-speed interface in the building of new-generation data center, and in combination with MTS2900 series switches, can provide comprehensive solution on high-guarantee and integrated and new-generation data centers in series for the building of the data center in the financial sector, government, operator and energy industries.

Basic devices

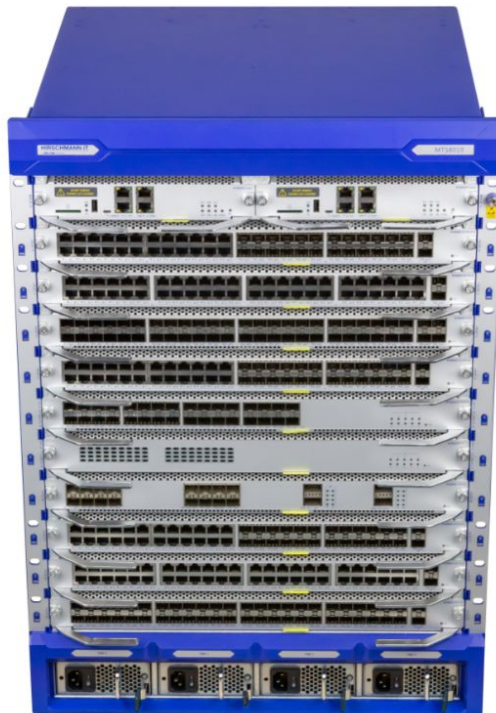

□ **Power module**



You can choose 1 to 4 power modules with the same input voltage: Power module is supplied as the accessory. Refer to "Order Number" on Page 21.

□ **Engine module**

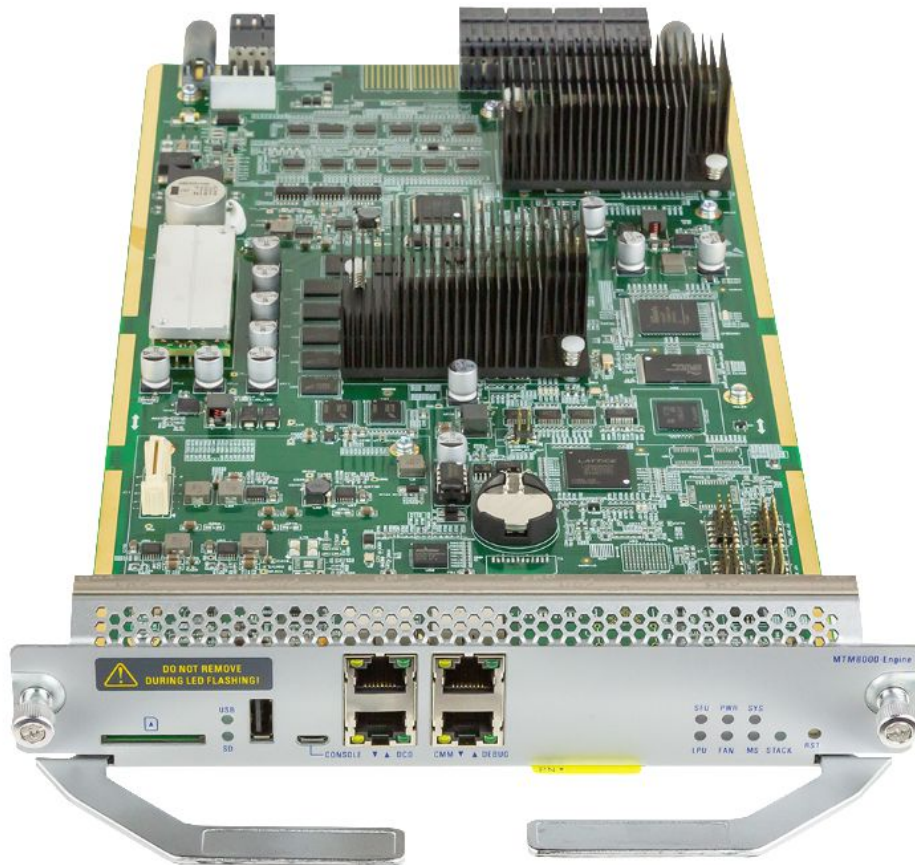

Engine module is the most important and necessary board card in MTS8010 switch, and serves as the control center of the device. Every machine frame shall be used with one engine module, and two modules can be supported at the same time, thus realizing the working mode of

1:1 backup. Engine module is supplied as the accessory. Refer to "Order Number" on Page 21.

Fan module



Provide 2 fan slots for the rear panel of the switch and use at least 2 fan modules.

Fan module is supplied as the accessory. Refer to "Order Number" on Page 21.

Medium module

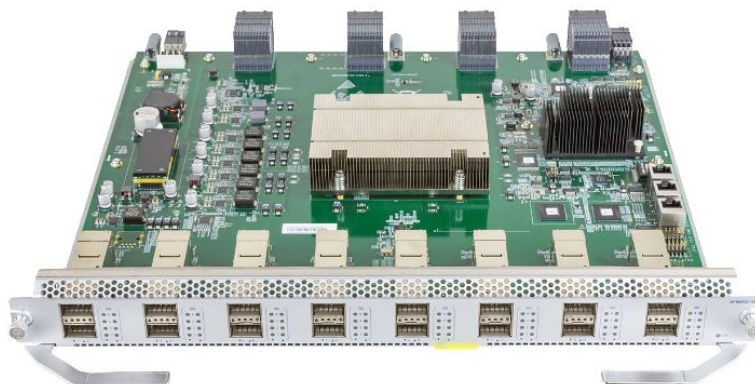

MTM8000-16Q-A

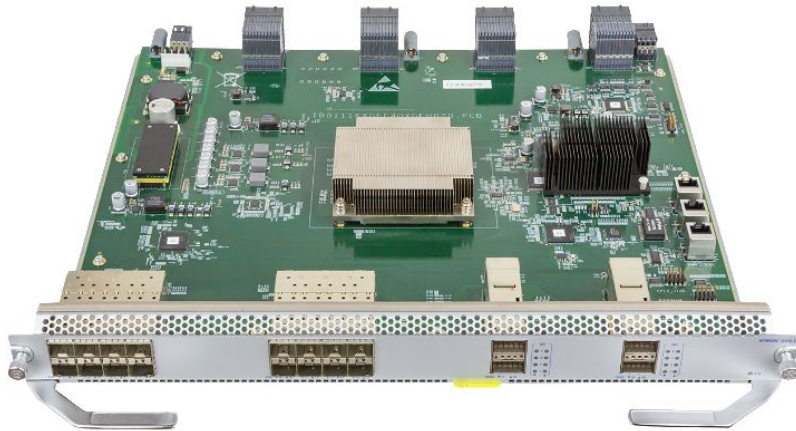

MTM8000-16X4Q-S



MTM8000-16X-S

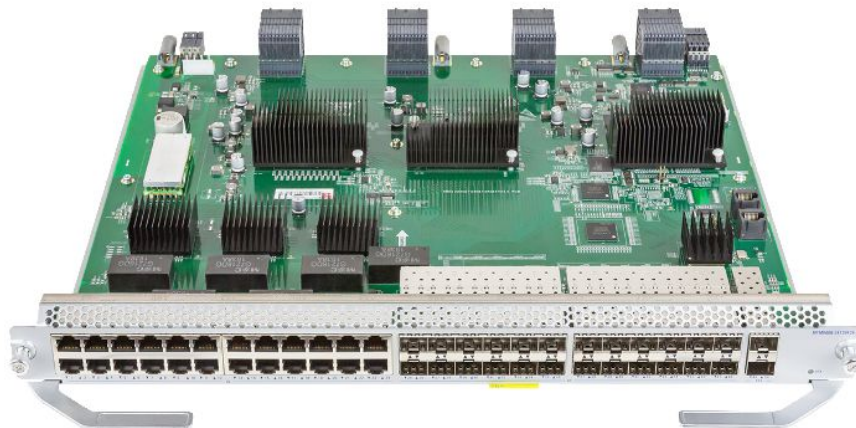

MTM8000-24T24F2X-S

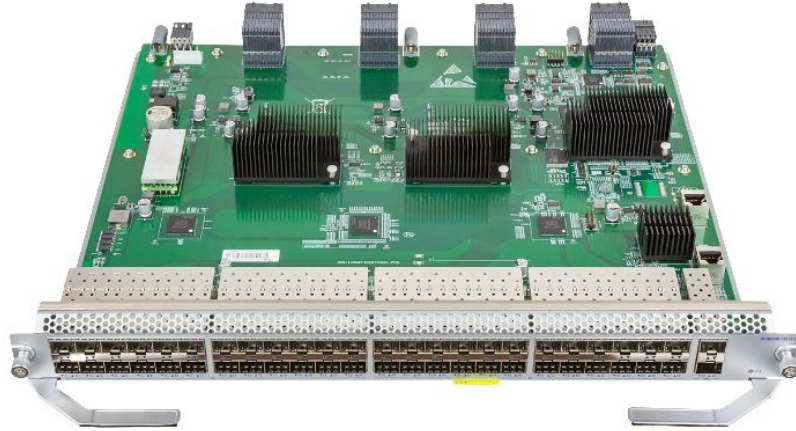

MTM8000-48F2X-S

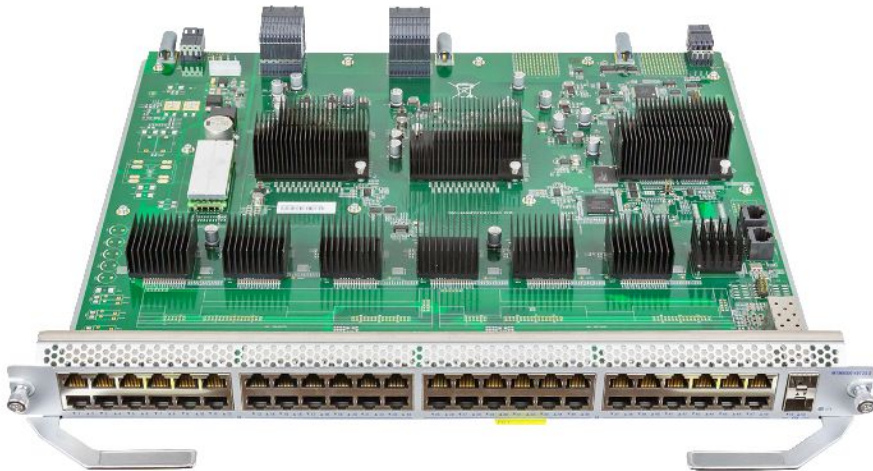

MTM8000-48T2X-S

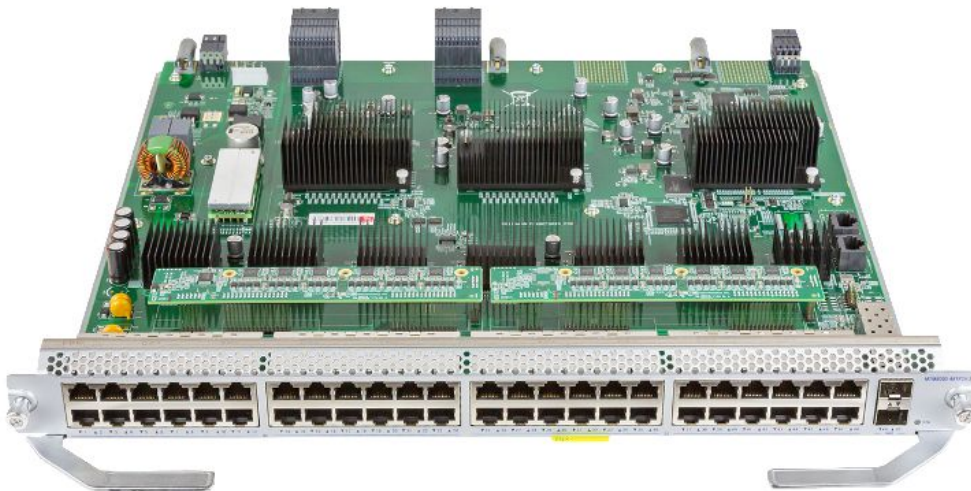

MTM8000-48TP2X-S

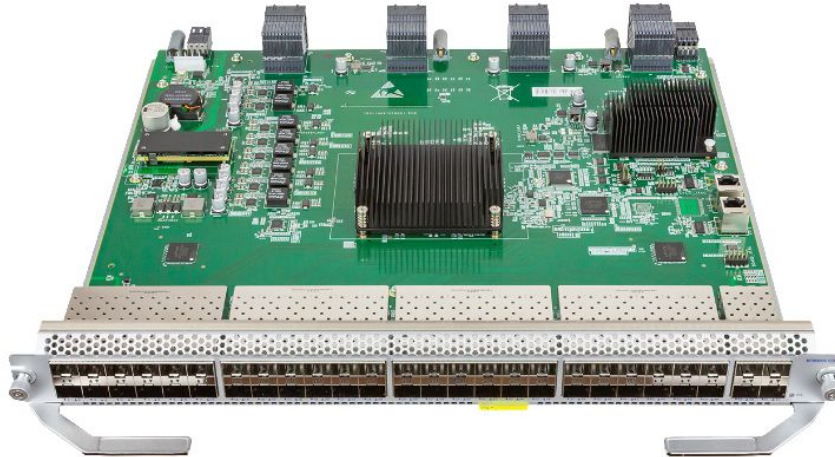

MTM8000-52X-A

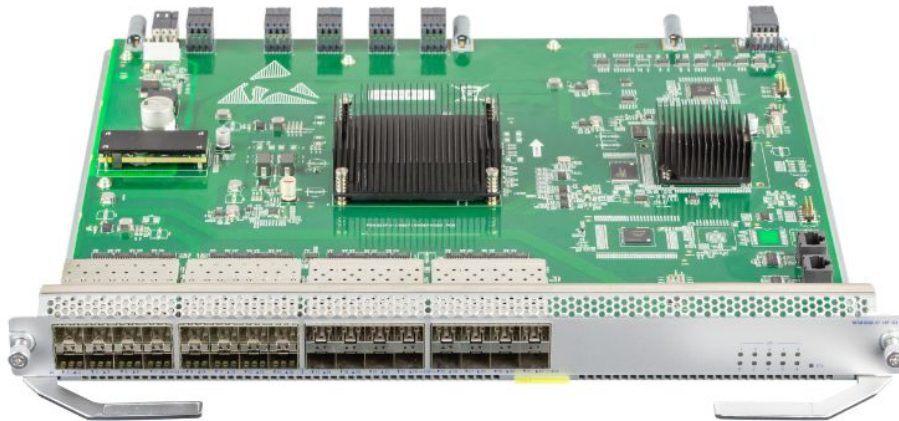

MTM8000-SF-16F16X-S



MTM8000-SF-24F8X-S



MTM8000-SF-A

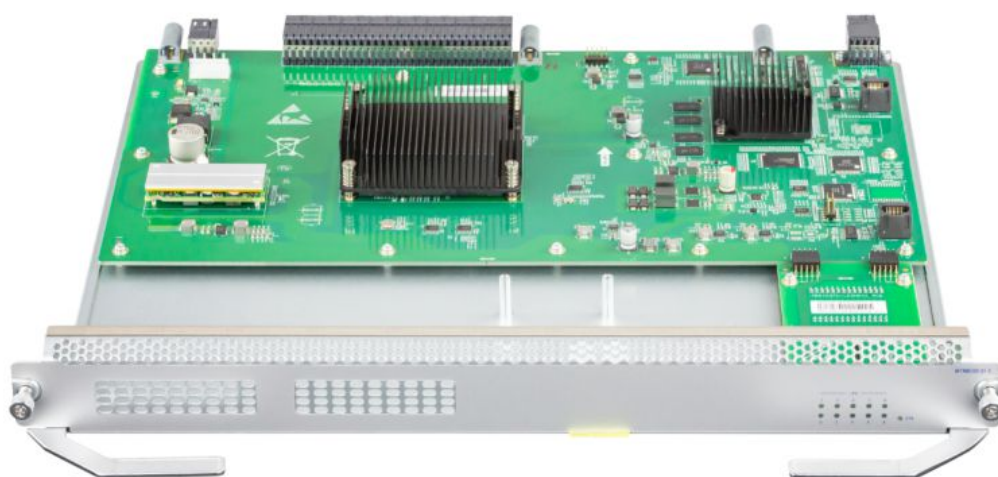

MTM8000-SF-S

The front panel of the switch has provided multiple types of different interface patterns available for the user choice, to meet the demands in various application scenarios. Medium module is supplied as the accessory. Refer to "Order Number" on Page 21.

1.2 Device name and product code

The device name corresponds to the product code.

1.2.1 Basic device

Order number	Product code	Description
942999791	MTS8010-Chassis	The rack-type 40G core-layer switch, 4 × power module slots, 2 × engine module slots, 10 × medium module slots, 2 × fan slots, and upgraded software.

1.2.2 Power module

Order number	Product code	Description
942999803	MTM8000-PSU800	AC/DC 800W power module; rated input voltage range 100-240V AC 50/60Hz, maximum input voltage range 90-264V AC 47~63Hz; output voltage 54V/12V DC; supporting hot plugging.

1.2.3 Engine module

Order number	Product code	Description
942999802	MTM8000-Engine	Engine module is the most important and necessary board card in MTS8010 switch, and serves as the control center of the device. Every machine frame shall be used with one engine module, and two modules can be supported at the same time, thus realizing the working mode of 1:1 backup.

1.2.4 Fan module

Order number	Product code	Description
--------------	--------------	-------------

942999797	MTM8010-FAN	Fan module is mandatory for MTS8010 switch, and supports hot plugging. Each MTS8010 switch has 2 fan slots, and two 2 fan modules must be installed to guarantee normal operation of the system.
-----------	-------------	--

1.2.5 Medium module

Order number	Product code	Description
942999806	MTM8000-48F2X-S	MTS8010 medium module; 48 × 100M/1000M SFP slots, 2 × 1/10G SFP+ slot
942999807	MTM8000-48T2X-S	MTS8010 medium module; 48 × FE/GE TX ports, 2 × 1/10G SFP+ slot
942999808	MTM8000-48TP2X-S	MTS8010 medium module; 48 × FE/GE TX PoE ports, 2 × 1/10G SFP+ slot
942999809	MTM8000-24T24F2X-S	MTS8010 medium module; 24 × FE/GE TX ports, 24 × 100M/1000M SFP slots, 2 × 1/10G SFP+ slot
942999810	MTM8000-16X-S	MTS8010 medium module; 16 × 1/10G SFP+ slot
942999811	MTM8000-16X4Q-S	MTS8010 medium module; 16 × 1/10G SFP+ slot, 4 × 40G QSFP+ slot
942999812	MTM8000-16Q-A	MTS8010 medium module; 16 × 40G QSFP+ slot, with high performance
942999814	MTM8000-52X-A	MTS8010 medium module; 52 × 1/10G SFP+ slot, with high performance
942999793	MTM8000-SF-A	High performance switch fabric for MTS8000
942999794	MTM8000-SF-S	Standard performance switch fabric for MTS8000
942999795	MTM8000-SF-24F8X-S	Hybrid card, standard switch fabric with 24 × 100M/1000M SFP slots, 8 × 1/10G SFP+ slots

942999796	MTM8000-SF-16F16X-S	Hybrid card, standard switch fabric with 16 × 100M/1000M SFP slots, 16 × 1/10G SFP+ slots
-----------	---------------------	---

1.2.6 Blank cover

Order number	Product code	Description
942999815	MTM8000-ModuleCover	Blank cover of the medium module of the switch
942999816	MTM8000-EngineCover	Blank cover of the engine module of the switch
942999817	MTM8000-PSUCover	Blank cover of the power module of the switch

1.3 Device view

1.3.1 MTS8010-Chassis

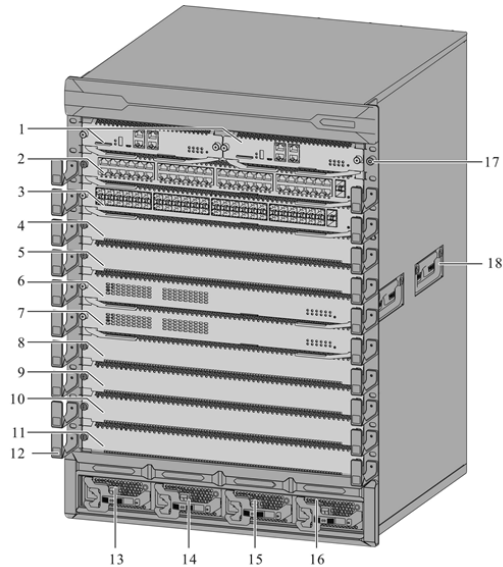

Front view

1 Slot 0 and 1 of engine module

2 Slot 0 of medium module

3 Slot 1 of medium module

4 Slot 2 of medium module

5 Slot 3 of medium module

6 Slot 4 of medium module

7 Slot 5 of medium module

8 Slot 6 of medium module

9 Slot 7 of medium module

10 Slot 8 of medium module

11 Slot 9 of medium module

12 Wire rack

13 Slot 0 of power module

14 Slot 1 of power module

15 Slot 2 of power module

16 Slot 3 of power module

17 Anti-static bracelet socket

18 Handle of the machine case

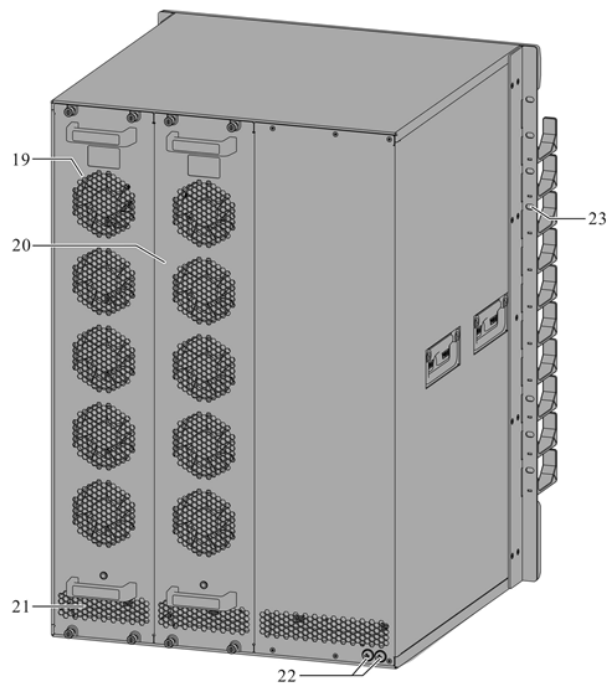

Rear view

19 Slot 0 of fan module

20 Slot 1 of fan module

21 Air outlet

22 Grounding stud

23 Upper cabinet screw hole

1.3.2 Power module

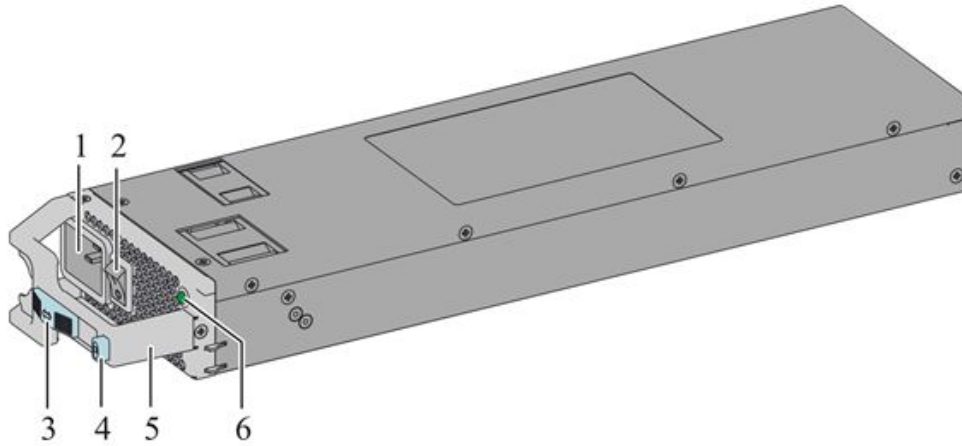

- | | |
|---|--------------------------------------|
| 1 | AC power socket |
| 2 | Power switch |
| 3 | Anti-stripping slider for power line |
| 4 | Power module unlocking button |
| 5 | Power handle |
| 6 | Power status indicator |

1.3.3 Engine module

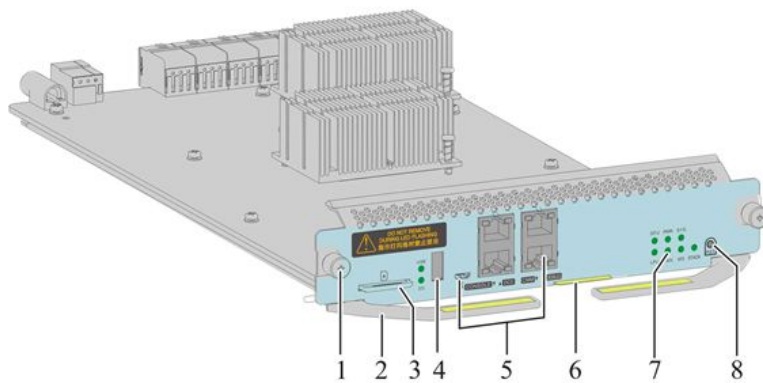

- | | |
|---|----------------------|
| 1 | Anti-loosening screw |
| 2 | Board card puller |
| 3 | SD card slot |

4	USB interface
5	Function port
6	Board card label slot
7	Function status indicator
8	Reset button

1.3.4 Fan module

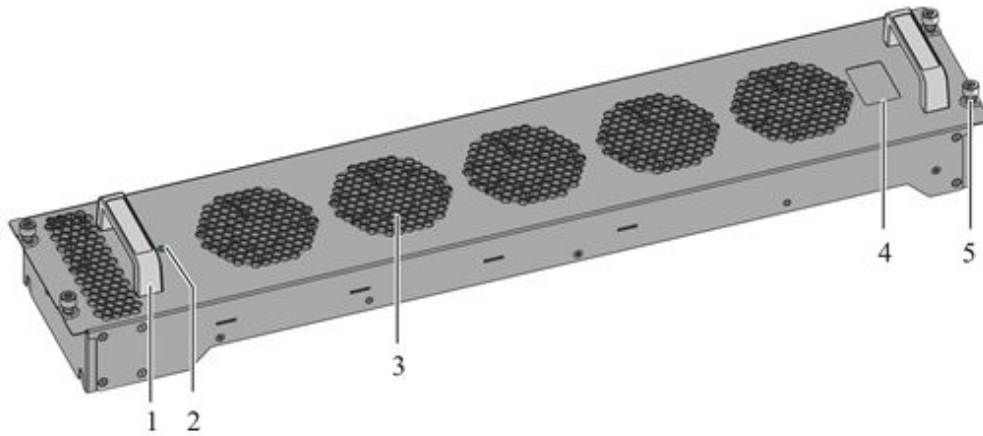

1	Install the handle
2	Fan status indicator
3	Air outlet of the fan
4	Fan label
5	Anti-loosening screw

1.3.5 Medium module

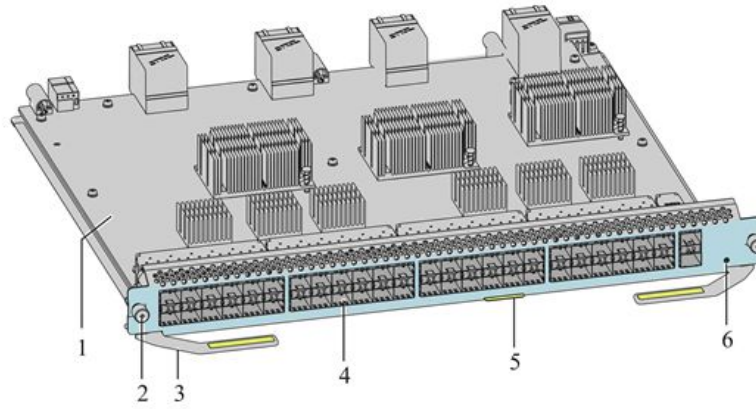

1 Printed circuit board

2 Anti-loosening screw

3 Board card puller

4 Function port

5 Board card label slot

6 Status indicator

1.3.6 Blank cover



Schematics of Blank cover of the engine module

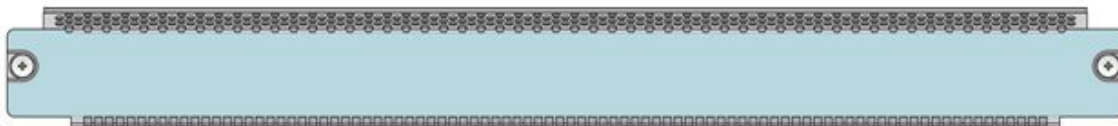

Schematics of the Blank cover of the medium module

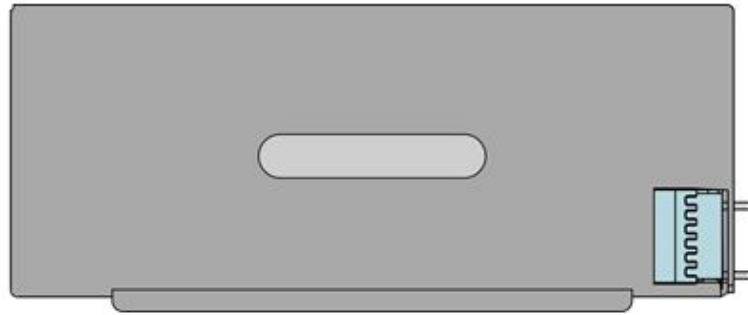

Schematics of Blank cover of the power module

1.4 Power supply

You may use the power module to supply voltage for the device:

See "Power Module" on Page 21 for the information related to the connecting power voltage.

1.5 Device port attribute

You may use twisted-pair cable or optical fiber (F/O) to connect the terminal devices and other network segments to this device and medium module port.

1.5.1 Console port attribute

Attribute	Description
Interface standard	Asynchronous EIA/TIA-232
Connector type	RJ45
Baud rate	9600- 115200 (default as 9600)
Supported service	Connect with the serial port of local terminal (such as PC), and run the terminal simulation program on the terminal

1.5.2 USB Console port attribute

Attribute	Description
Interface standard	USB2.0
Connector type	Micro USB
Interface rate	12Mbps
Supported service	Connect with the USB of local terminal (such as PC), and run the terminal simulation program on the terminal (baud rate setting range is 9600bit/s-115200bit/s (default as 9600bit/s))

1.5.3 10Base-T/100Base-TX/1000Base-T RJ45 electric interface attribute

Attribute	Description
Interface standard	IEEE 802.3、IEEE802.3u、IEEE802.3ab、IEEE802.3az
Connector type	RJ45
Working mode	10Mbps/100Mbps/1000Mbps Half duplex/full duplex/auto-negotiation
Maximum transmission distance	100m
Connected cable	Cat. 5 and 5e twisted pairs

1.5.4 10GBase-T RJ45 electric interface attribute

Attribute	Description
Interface standard	IEEE 802.3an、IEEE802.3ab、IEEE802.3u
Connector type	RJ45
Working mode	10Gbps (full duplex) 1000Mbps (half duplex/full duplex) Auto-negotiation
Maximum transmission distance	100m
Connected cable	Cat. 6e and above shielded twisted pairs (S/FTP)

1.5.5 1000Base-X SFP optical interface attribute

Attribute	Description
Interface standard	IEEE 802.3z
Connector type	SFP
Working mode	1000Mbps full duplex/1000Mbps auto-negotiation
Support SFP interface	Support 1000Base-X
Connected cable	Single mode optical fiber of multimode optical fiber

1.5.6 10GBase-SR/LR/ER SFP+ optical interface attribute

Attribute	Description
Interface standard	Conform to the standard IEEE 802.3ae
Connector type	SFP+
Working mode	10Gbps/1000Mbps full duplex
Support SFP+ interface	Support 10GBase-SR Support 10GBase-LR Support 10GBase-ER
Connected cable	Single mode optical fiber of multimode optical fiber

1.5.7 40GBase-SR4/LR4 QSFP+ optical interface attribute

Attribute	Description
Interface standard	Conform to the standard IEEE 802.3ba
Connector type	QSFP+

Attribute	Description
Working mode	40Gbps full duplex
Support QSFP+ interface	Support 40GBase-SR4/LR4
Connected cable	Single mode optical fiber of multimode optical fiber

1.5.8 USB interface attribute

Attribute	Description
Interface standard	USB2.0
Interface type	USB Type A
Working mode	1.5Mbps, 12Mbps and 480Mbps Host, supporting hot plugging and controlled (command mode) hot plugging. (Hot plugging operation is not allowed in the data transmission)
Cable	No

1.5.9 SD interface attribute

Attribute	Description
Interface standard	SD Host Controller Standard Specification, Version 2.0
Interface type	SD
Working mode	Support hot plugging and controlled (command mode) hot plugging. (Hot plugging operation is not allowed in the data transmission)
Cable	No

1.5.10 POE interface attribute

Attribute	Description
Interface standard	IEEE 802.3af IEEE 802.3at
Interface type	RJ45
Working mode	Alternative A: 1, 2 being negative, and 3, 6 being positive for MDIX. Support

Attribute	Description
	1000base-T.
Cable	No

For more information, see **"User Manual for Command Line Interface"**.
You can download this manual from Hirschmann IT product page:
<https://hirschmann-it.support.belden.com> .

1.6 Display unit

After the setting of the power voltage, the software will automatically start and be initialized. Then the device will start the self-check. During this course, the LED indicator will be ON.

1.6.1 Device status

These LEDs provide the condition information influencing the operation of the whole device.

Category of the indicator	Name of the indicator	Color of indicator	Status
System status indicator	SYS	Green	Fast flashing (5Hz flashing frequency): indicates that the hardware starts working since the power is supplied Slow flashing (0.5Hz flashing frequency): indicates that the system is in normal operation Normally ON/OFF: indicates that the system is in abnormal operation
Power indicator	PWR	Green	Normally ON: indicates that all power modules in place are in normal operation OFF: indicates that the power modules in place are in abnormal status
Fan indicator	FAN	Green	Normally ON: indicates that all fan modules on the device are in normal operation OFF: indicates that at least one (1) fan module on the device is in abnormal status
STACK indicator	STACK	Green	Flash: indicates that the stacking function is enabled, and this is the main device for the stacking system Normally ON: indicates that the stacking function is enabled, and this is not the main device for the stacking system Normally OFF: indicates that the stacking function is not enabled
ID indicator	ID	Blue	Fast flashing (5Hz flashing frequency): for the field operation, and remote control of the ON and OFF status of ID LED by the operation and maintenance personnel OFF: ID LED is not enabled, default status

1.6.2 Port status

These LEDs provide the related information of the ports.

Category of the indicator	Name of the indicator	Color of indicator	Status
Serial port indicator	TXD	RJ45 self-supplied with yellow LED	Flash: indicates that there is data sent out of the serial port OFF: indicates that there is no data sent out of the serial port
	RXD	RJ45 self-supplied with green LED	Flash: indicates that there is data received in the serial port OFF: indicates that there is no data received in the serial port
DC0 interface indicator	1000M	RJ45 self-supplied with yellow LED	OFF: DC0 interface works in 10/100M or stays in the un-linked status ON: DC0 interface works in 1000M
	ACT	RJ45 self-supplied with green LED	OFF: DC0 interface is not Linked Normally ON: DC0 interface is Linked, but without data transmission and receiving Flash: DC0 interface is Linked, and with data transmission and receiving
Port status indicator	LINK/ACT	Green	Normally ON: Ethernet interface is linked Flash: there is data transmission and receiving in the Ethernet interface OFF: Ethernet interface is not linked
40G port BREAK OUT indicator	40G BREAKOUT	Green	Normally ON: at least one 40GE interface works in 10GE mode, and is split into four (4) 10GE interfaces. When any one or more 40GE interfaces are configured as four (4) 10GE interfaces, BREAKOUT LED is invalid and it is required to use 40G interface indicator to distinguish the 10GE interfaces: If the port LED indicator 1 is ON, then every interface indicator indicates that the status of the first (1st) 10GE interface in this interface. If the port LED indicator 2 is ON, then every interface indicator indicates that the status of the second (2nd) 10GE interface in this interface.

Category of the indicator	Name of the indicator	Color of indicator	Status
			<p>If the port LED indicator 3 is ON, then every interface indicator indicates that the status of the third (3rd) 10GE interface in this interface.</p> <p>If the port LED indicator 4 is ON, then every interface indicator indicates that the status of the fourth (4th) 10GE interface in this interface.</p> <p>OFF: the 40GE interface works in 40GE mode, and is not split into four (4) 10GE interfaces</p>

1.7 Management interface

1.7.1 DC0 interface (external management)

The serial interface is provided on RJ45 socket (DC0 interface), to realize the local connection of external management station (VT100 terminal or PC with corresponding terminal simulation), thus allowing you to build the connection with the command line interface CLI and system monitor.

1.7.2 USB interface

The switch provides two serial interfaces (EIA/TIA-232 and Micro USB 2.0). With these two interfaces, the user can configure the switch by using the PC computer (or laptop computer) with RS-232 serial interface (or USB interface).

2 Installation

These devices are developed for the use in the commercial environment. At the time of delivery, the devices are ready for being put into operation.

Execute the following steps to install and configure the device:

- Unpacking and inspection
- Install the cover and power module (optional)
- Device installation and earthing
- Operate the device
- Install SFP transceiver (optional)
- Connect the data cable
- Fill in the label

2.1 Unpacking and inspection

- Check whether the packing box contains all articles specified in "Delivery Items" on Page 59.
- Check the transportation and damage of the parts and components one by one.

2.2 Install the power module (optional)

2.2.1 Install the power module

Hirschmann IT provides the power module for operation being ready. You may choose to install the power module during the device operation.

Operate in the following steps:

- Dismantle the cover plate (if installed) from the power module slot of the device.
- Insert the power module into the slot.

2.3 Device installation and earthing

You may use the following options to install the device:

- Installation in the switch cabinet
- Installation on the vertical and flat surface

Warning

Electric shock

Such devices are only installed in the switch cabinet or in the restricted operation field, and can be accessed only by the maintenance personnel.

Failure to observe this guideline might result in severe injury or death or device damage.

Caution

Too Hot Device

In the device installation, ensure that the ventilation duct is not covered.

Failure to observe these guidelines might result in mild injury or device damage.

Installation in the switch cabinet

Note: When the device is operated in the environment with continuous vibration load more than 0.7 g, the device must be additionally fixed on the switch cabinet by using two (2) mounting brackets on the front and back of the device.

The auxiliary bracket is supplied as the accessory. Refer to "Accessories" on Page 59.

Prerequisite:

- Install the device with the help of the sliding or mounting guide rail into 19" switch cabinet.
 - This can increase the stability of the device in the environment influenced by vibration.
 - For more information about the sliding/mounting guide rails and how to install them, contact the manufacturer of the switch cabinet.
- Such device is intended for installation in 19" switch cabinet.
 - At the time of delivery, there are two (2) pre-installed mounting brackets on the side of the device.
- Ensure good ventilation. If necessary, install the fan to prevent the device being too

hot.

- Measure the depth of 19" cabinet, to facilitate easy insertion of all connection circuits.

Operate in the following steps:

- Assemble the sliding or mounting guide rail into 19" switch cabinet according to the regulations of the manufacturer.
 - The device is installed on the guide rail of the switch cabinet.
Tighten the bracket onto the switch cabinet with the screws, to fix the device.
- **Installation on the vertical and flat surface**

Warning

Fire hazard

In case of vertical installation, install the device in the fireproof enclosure.

Failure to observe this guideline might result in severe injury or death or device damage.

Operate in the following steps:

- Use the pre-installed bracket, as shown in the figure below.
- In addition, connect two (2) brackets onto the back of the device.
- The auxiliary bracket is supplied as the accessory. Refer to "Accessories" on Page 59.
- Tighten the bracket onto the wall with the screws, to fix the device.

Device earthing

The device has the connection with the protective earthing wire.

The device is earthed by the earthing screw and power socket.

Operate in the following steps:

- Earth the device with the earthing screws
You may check the tightening torque stipulated in "General Technical Data" on Page 50.

2.4 Install SFP transceiver (optional)

Prerequisite:

Only Hirschmann IT SFP transceiver is used. Refer to "Accessories" on Page 59.

Operate in the following steps:

- Take off the protective cover from SFP transceiver.

- Insert SFP transceiver into the slot, till it is locked.

2.5 Operate the device

Operate in the following steps:

- Fix the connector on the device by the screws.
You may check the tightening torque stipulated in "General Technical Data" on Page 50.
- Enable the power voltage.

2.6 Connecting the data cable

In the environment with high electrical interference, notice the following general suggestions related to the data cable connection:

- Shorten the length of the data cable as much as possible.
- Use optical fiber data cable for data transmission between the buildings.
- When using the copper cable, fully separate the power cable from the data cable. Preferably, install it in separate cable channel.
- Ensure that the power cable and data cable will not be arranged in parallel for long distance, preferably install them in different cable channels. If it is required to reduce the inductive coupling, it is required to ensure that the power cable and data cable are crossed at 90°.
- Use the SF/UTP cable conforming to the requirements of ISO/IEC 11801:2002.
- Connect the data cable according to your need.

For more information, consult "Device Name and Product Code" on Page 21.

2.7 Fill in the label

The MAC address information on the front of the device can help you to identify such device.

3 Carry out the basic setting

Note: Configuring two or more devices with the same IP address might cause the network to be incapable of expected operation. Install and maintain one program to distribute a unique IP address for every device in the network.

When installing the device for the first time, input IP parameters.

4 Monitor the ambient air temperature

Operate this device below the designated maximum ambient air temperature.

Refer to "General Technical Data" in Page 50.

The ambient air temperature is the air temperature 2 inch (5cm) from the device, depending on the installation conditions of the device, for example, the distance between such device and other device or other object, and the output of the adjacent device and so on.

5 Repair and maintenance

- When designing this device, Hirschmann IT has made the greatest efforts to avoid the use of highly wearable components. In normal operation, the service life of the wearable parts is longer than that of the product itself. Make sure to operate this device according to the product instruction.
- The relay is susceptible to natural wearing. Such wear depends on the switching frequency. Check the resistance and switch functions of the contact point of the relay according to the switching frequency.
- Only when detecting the error, can the device trigger the internal fuse. In case of the device damage or fault, it is required to cut off the power supply and return the device to the factory for inspection.
- Hirschmann IT is devoted to improving and developing the software. You should browse our website occasionally, to check whether the update software version providing additional advantages has been put into the market. You can log in Hirschmann IT product page: <https://hirschmann-it.support.belden.com> to check the information and download the software.
- Regularly check whether the ventilation channel in the device is blocked according to the contamination degree in the operating environment.

You can log in

<http://www.beldensolutions.com/en/Service/Repairs/index.phtml> to check the complaint handling.

6 Remove

6.1 Remove the power module

Operate in the following steps:

- Wear the anti-static bracelet, and confirm that the anti-static bracelet can be reliably earthed.
- Turn off the power switch.
- Unlock the power cable, and unplug the power line.
- Unlock the power module, and pull it out.
- Use the cover plate to seal the slot of the medium module on the basic device.

6.2 Remove the fan module

Operate in the following steps:

- Wear the anti-static bracelet, untighten the two anti-loosening screws on the lower and upper parts of the fan module with Phillips screwdriver.
- Pull the handle of the fan module with one hand, hold the fan frame of the fan module with the other hand, pull out the fan module stably along the guide rail of the slot, and place the dismantled fan module onto the antistatic cushion or initial packing box.
- Use the cover plate to seal the slot of the medium module on the basic device.
- Fix the cover plate with two (2) screws on the basic device.
You may check the tightening torque in "General Technical Data" on Page 50.

6.3 Remove SFP transceiver

Operate in the following steps:

- Unlock, and pull SFP transceiver out of the slot.

- Seal the SFP transceiver with protective cover.

6.4 Remove engine or medium module

Operate in the following steps:

- Untighten the screws on the front panel of the engine or medium module.
- Press the locking lever outward to release the locking of the engine or medium module (steps **1** and **2**).
- Pull the engine or medium module out of the slot (step **3**).
- Use the cover plate to seal the slot of the engine or medium module on the basic device.
- Fix the cover plate with two (2) screws on the basic device.

You may check the tightening torque in "General Technical Data" on Page 50

6.5 Remove the device

Warning

Electric shock

Disconnect all other cables and then disconnect the earth wire.

Failure to observe this guideline might result in severe injury or death or device damage.

Operate in the following steps:

- Disconnect the data cable.
- Disable the power voltage.
- Disconnect the power line.
- Disconnect the earthing wire.
- To remove the device from the switch cabinet or wall, it is required to

untighten the screws on the bracket of the device.

7 Technical data

7.1 General technical data

Basic devices

Size	Refer to "Dimensional Drawing" on Page 52		
Weight	32.48kg (machine frame)		
Power supply	Rated voltage range	100 VAC ... 240 VAC	,50 Hz ... 60 Hz
		Maximum conductor diameter	AWG12 (2.5 mm ²)
Device earthing	Tightening torque Protective earthing	3.5~6.1 lb-in (0.4~0.7 Nm)	
Climatic conditions in the operation	Ambient air temperature	-5°C~55°C (2000m)	
Climatic conditions in the storage period	Humidity	10%-90%/RH, without condensation	
	Altitude	<2000m	
Contamination degree	2		
Protective class	Laser protection	Conform to Class 1 in requirements of IEC 60825-1	
	Protection level	IP20	

Power module

Size	Refer to "Dimensional Drawing" on Page 52		
Weight	MTM8000-PSU800	1.98Kg	
Power module	Rated voltage range	100 VAC ... 240 VAC	,50 Hz ... 60 Hz

Engine module

Size	Refer to "Dimensional Drawing" on Page 52	
Weight	MTM8000-Engine	1.48Kg
Installation of power module	Tightening torque	3.5~5.2 lb-in (0.4~0.6 Nm)
Installation of the cover plate	Tightening torque	3.5~5.2 lb-in (0.4~0.6 Nm)

Fan module

Size	Refer to "Dimensional Drawing" on Page 52	
Weight	MTM8010-FAN	2.60Kg
Install the fan module	Tightening torque	3.5~5.2 lb-in (0.4~0.6 Nm)
Install the cover plate	Tightening torque	3.5~5.2 lb-in (0.4~0.6 Nm)

Medium module

Size	Refer to "Dimensional Drawing" on Page 52	
weight	MTM8000-48F2X-S	3.44Kg
	MTM8000-48T2X-S	3.32Kg
	MTM8000-48TP2X-S	3.48Kg
	MTM8000-24T24F2X-S	3.62Kg
	MTM8000-16X-S	3.36Kg
	MTM8000-16X4Q-S	3.32Kg
	MTM8000-16Q-A	3.78Kg
	MTM8000-52X-A	3.38Kg
	MTM8000-SF-A	3.08Kg
	MTM8000-SF-S	2.80Kg
	MTM8000-SF-24F8X-S	3.34Kg
MTM8000-SF-16F16X-S	3.34Kg	
Install the medium module	Tightening torque	3.5~5.2 lb-in (0.4~0.6 Nm)
Install the cover plate	Tightening torque	3.5~5.2 lb-in (0.4~0.6 Nm)

7.2 Dimensional Drawing

□ Basic devices

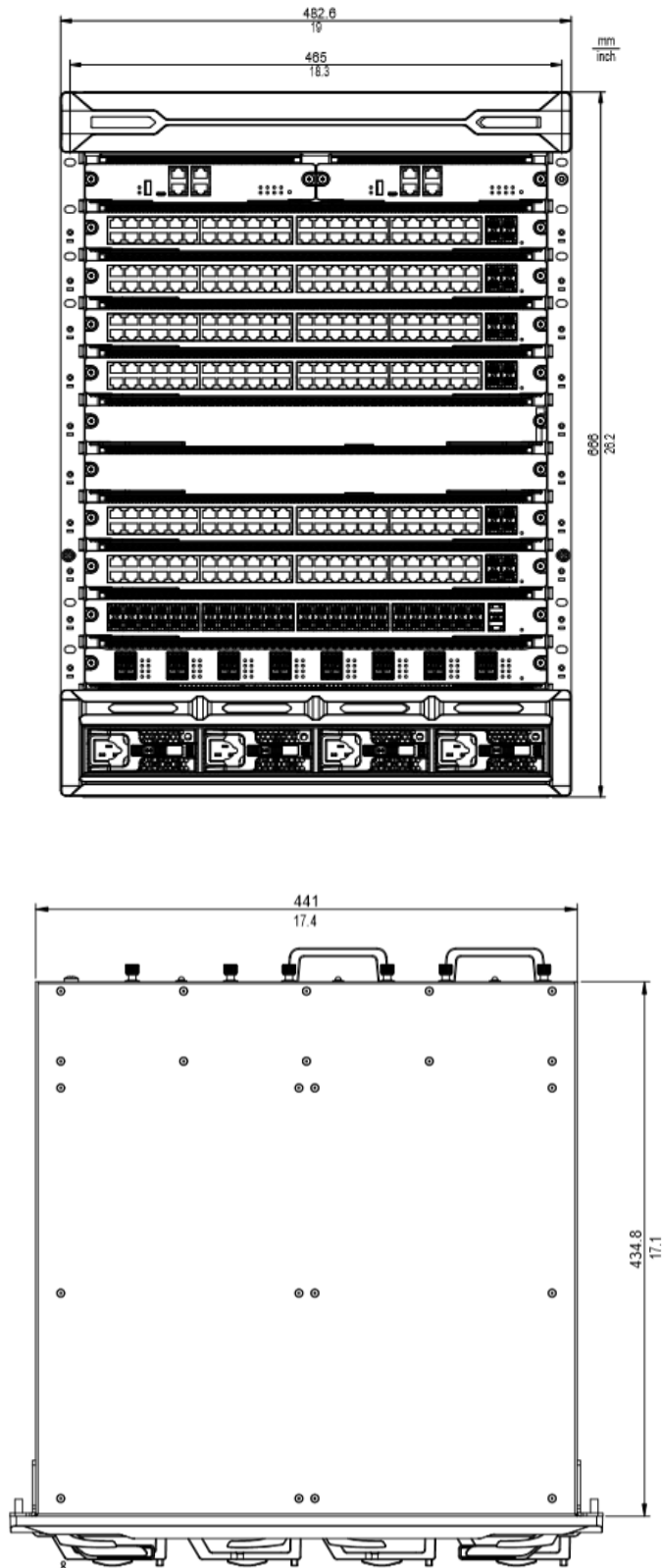

□ Power module

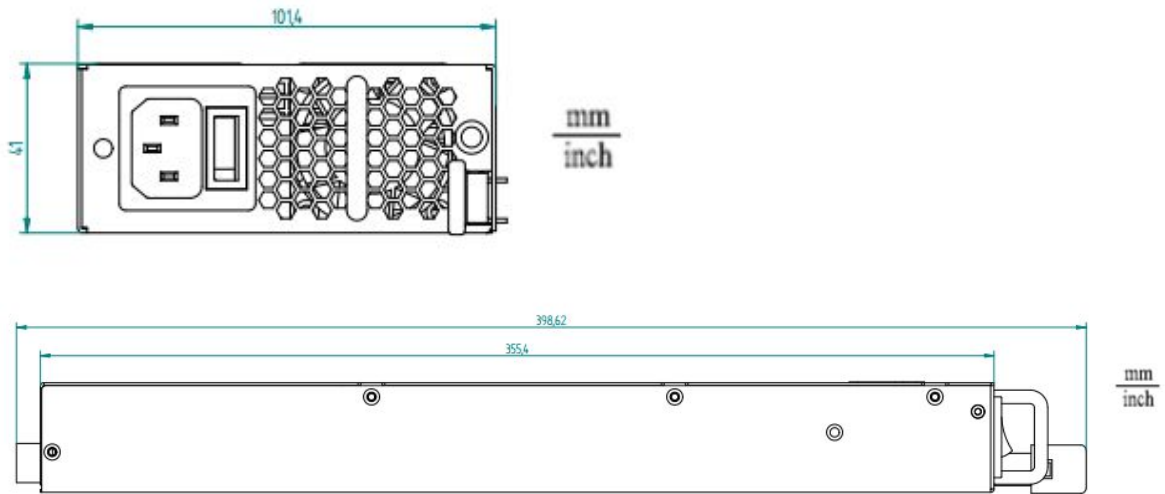

□ Engine module

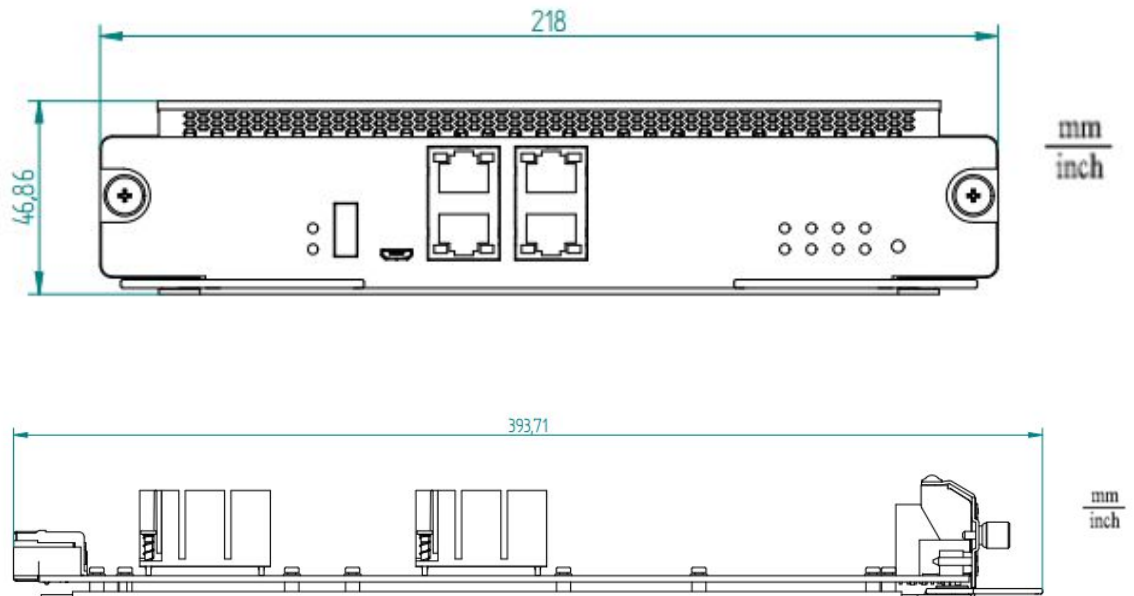

□ Fan module

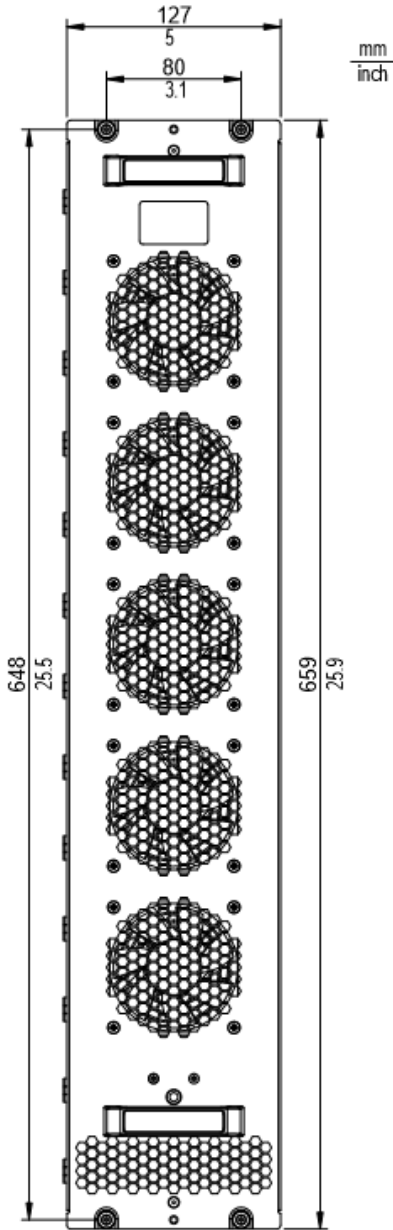

□ **Medium module**

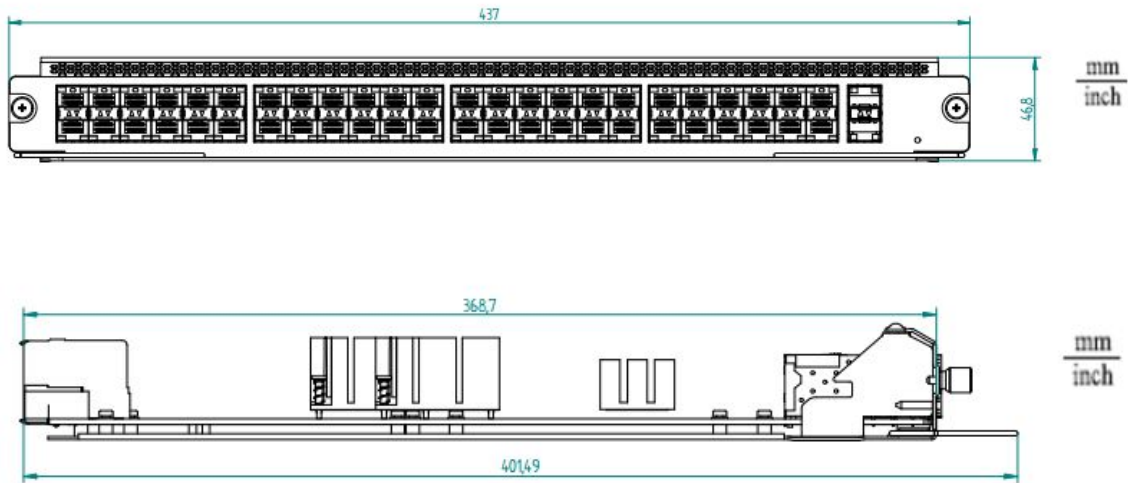

7.3 EMC and interference immunity

EMC interference emission		Standard application
EN 55032		Class A
DNV GL guideline		—
FCC 47 CFR Part 15		Class A
EN 61000-6-4		Compliance
EN 55032	AC/DC power line	Class A
DNV GL guideline	AC/DC power line	—
FCC 47 CFR Part 15	AC/DC power line	Class A
EN 61000-6-4	AC/DC power line	Compliance
EN 55032	Signal wire	Class A
EN 61000-6-4	Signal wire	Compliance
Harmonic current		
EN 61000-3-2		Class A
Voltage flicker		
EN 61000-3-3		

EMC interference immunity		Standard application
Electrostatic discharge		
EN 61000-4-2	Contact discharge	±4 kV
IEEE C37.90.3		
EN 61000-4-2	Air discharge	±8 kV
IEEE C37.90.3		

EMC interference immunity		Standard application
Electromagnetic field		
EN 61000-4-3	80 MHz ... 1000 MHz	10 V/m
	1000 MHz ... 6000 MHz	3 V/m
IEEE 1613	80 MHz ... 1000 MHz	—
Fast transient (burst)		
EN 61000-4-4	AC/DC power line	±2 kV
IEEE C37.90.1		
EN 61000-4-4	Data line	±1 kV
IEEE C37.90.1		
Voltage surge – Power line		
EN 61000-4-5	Line/Earth	±2 kV
EN 61000-4-5	Line/Line	±1 kV
Voltage surge – data line		
EN 61000-4-5	Line/Earth	±1 kV
Conductive immunity		
EN 61000-4-6	150 kHz ... 80 MHz	10 V

EMC interference immunity		Standard application
Damped vibration – AC/DC power line		
EN 61000-4-12 IEEE C37.90.1	Line/Earth	—
EN 61000-4-12 IEEE C37.90.1	Line/Line	—
Damped vibration - Data line		
EN 61000-4-12 IEEE C37.90.1	Line/Earth	—
EN 61000-4-12	Line/Line	—
Pulsed magnetic field		
EN 61000-4-9		—
Power-frequency magnetic field		
EN 61000-4-8		30A/m
Voltage dip and short interruption		
EN 61000-4-11	AC/DC power line	20 ms ΔU 100 % 200ms ΔU 60 % 500ms ΔU 30 % 5s ΔU 100 %

Stability		Standard application
IEC 60068-2-6, test Fc	Vibration	5 Hz ... 8.4 Hz, vibrating amplitude 0.14 in. (3.5 mm) 8.4 Hz ... 150 Hz / 1g
IEC 60068-2-27, test Ea	Vibration	15 g / 11 ms

7.4 Network range

Note: the line length specified for the transceiver applies to the related optical fiber data (optical fiber attenuation and BLP/dispersion).

Product code	Mode ^a	Wavelength	F/O cable length example ^b	Optical fiber attenuation	BLP/dispersion
MTS-SFP-10G-...-SR/LC...	MM	850 nm	300 m (> 5.1 dB link budget at 850nm)	3.0 dB/km	-
-LR/LC...	SM	1310 nm	10 km (> 6.6 dB link budget at 1310 nm)	0.32 dB/km	-
-ER/LC...	SM	1550 nm	40 km (> 15 dB link budget at 1550 nm)	0.18 dB/km	18 ps/(nmxkm)
-TX/RJ45...	TX/RJ45	Full-duplex adaptive	30 m	-	-

Table 3: 10G SFP module of optical fiber port

a. MM = multimode, SM = single mode

b. When observing the optical fiber data, 3 dB system reserve is included

Product code	Mode ^a	Wavelength	F/O cable length example ^b	Optical fiber attenuation	BLP/dispersion
MTS-SFP-40G-...-SR/LC...	MM	850 nm	100m(OM3), 150m(OM4) > 3.5 dB link budget at 850 nm	3.0 dB/km	-
-LR/LC...	SM	1310 nm	10 km < 7.5 dB link budget at 1310 nm	0.32 dB/km	-

Table 4: 40G SFP module of optical fiber port

a. MM = multimode, SM = single mode

b. When observing the optical fiber data, 3 dB system reserve is included

7.5 Power consumption/power output

Name	Maximum power consumption
MTM8010-FAN	47W
MTM8000-Engine	30W
MTM8000-48F2X-S	77W
MTM8000-48T2X-S	77W
MTM8000-48TP2X-S	77W
MTM8000-24T24F2X-S	92W
MTM8000-16X-S	82W
MTM8000-16X4Q-S	115W
MTM8000-16Q-A	151W
MTM8000-52X-A	166W
MTM8000-SF-A	155W
MTM8000-SF-S	52W
MTM8000-SF-24F8X-S	112W
MTM8000-SF-16F16X-S	112W

8 Delivery item, order number and accessories

Delivery item

Quantity	Article
1	Device
1	General Safety Guideline
2	Bracket

Order number

MAMMUTHUS switch	MTS8010-Chassis	942 999 791
MAMMUTHUS power module	MTM8000-PSU800	942 999 803
MAMMUTHUS fan module	MTM8010-FAN	942 999 797
MAMMUTHUS engine module	MTM8000-Engine	942 999 802
MAMMUTHUS medium module	MTM8000-48F2X-S	942 999 806
	MTM8000-48T2X-S	942 999 807
	MTM8000-48TP2X-S	942 999 808
	MTM8000-24T24F2X-S	942 999 809
	MTM8000-16X-S	942 999 810
	MTM8000-16X4Q-S	942 999 811
	MTM8000-16Q-A	942 999 812
	MTM8000-52X-A	942 999 814
	MTM8000-SF-A	942 999 793
	MTM8000-SF-S	942 999 794
	MTM8000-SF-24F8X-S	942 999 795
	MTM8000-SF-16F16X-S	942 999 796
MAMMUTHUS Blank cover	MTM8000-ModuleCover	942 999 815
	MTM8000-EngineCover	942 999 816
	MTM8000-PSUCover	942 999 817

Accessories

Note that, the product used as the accessory might have the characteristics different from that of the device itself, and thus limiting the scope of use for the whole system. For example, if you add IP20 accessory into IP 65 device, it will result in the degradation of the whole system to IP20.

1G SFP module	Order number
MTS-SFP-1G-TX/RJ45	942 999 854
MTS-SFP-1G-SX/LC	942 999 855
MTS-SFP-1G-LX/LC	942 999 856
MTS-SFP-1G-LX+/LC	942 999 857
MTS-SFP-1G-LH/LC	942 999 858
MTS-SFP-1G-LH+/LC	942 999 859
MTS-SFP-1G-BIDI-TypeA-LX/LC	942 999 860
MTS-SFP-1G-BIDI-TypeB-LX/LC	942 999 861
MTS-SFP-1G-LX+/LC-1550	942 999 862
10G SFP module	Order number
MTS-SFP-10G-SR/LC	942 999 851

MTS-SFP-10G-LR/LC	942 999 852
MTS-SFP-10G-ER/LC	942 999 853
MTS-SFP-10G-TX/RJ45	942 999 867

40G SFP module	Order number
MTS-SFP-40G-SR/LC	942999863
MTS-SFP-40G-LR/LC	942999864

- a. You may find more information about the certificate on the Hirschmann IT product webpage (<https://hirschmann-it.support.belden.com>).

9 Basic technical criteria

Name	
FCC 47CFR Part 15	Code of Federal Regulations
IEC 60825-1	Laser product safety
EN 55032	Electromagnetic compatibility of multimedia equipment - Emission requirements
EN 62368-1	Information technology equipment - Safety - Part 1: General requirements
EN 61000-3-2	Electromagnetic compatibility (EMC) – Part 3-2: Limits – Limits for harmonic current emissions (equipment input current ≤ 16 A per phase)
EN 61000-3-3	Electromagnetic compatibility (EMC) - Part 3-3: Limits - Limitation of voltage changes, voltage fluctuations and flicker in public low-voltage supply systems, for equipment with rated current Less than or equal to 16 A per phase and not subject to conditional connection
EN 61000-6-2	Electromagnetic compatibility (EMC)- Part 6-2: Generic standards - Immunity standard for industrial environments
EN 61000-6-4	Electromagnetic compatibility (EMC) - Part 6-4: Generic standards - Emission standard for industrial environments
EN 61131-2	Programmable controllers - Part 2: Equipment requirements and tests

Table 5: Technical Standard List

The equipment usually meets the technical standard mentioned in the latest version.

Only when the device enclosure is attached with the certification mark, can it mean that the device has passed the specific standard certification.

A More support

Technical problems

In case of any technical problem, contact your local Hirschmann IT distributor or Belden.

You may search the addresses of our partners from the website:
<https://hirschmann-it.support.belden.com>.

For the local telephone number and email list of Hirschmann IT direct technical support, visit:
<https://hirschmann-it.support.belden.com>.

This website also includes the knowledge base and software download section provided for free.

HIRSCHMANN IT

A **BELDEN** BRAND