

Manual

PROFINET

LioN-X IO-Link Master Multiprotocol:

0980 XSL 3912-121-007D-00F (8 x IO-Link Class A)

0980 XSL 3912-121-007D-01F (8 x IO-Link Class A)

LioN-Xlight IO-Link Master PROFINET:

0980 LSL 3011-121-0006-001 (8 x IO-Link Class A)

0980 LSL 3010-121-0006-001 (4 x IO-Link Class A + 8 x DI)



Contents

1 About this manual	9
1.1 General information	9
1.2 Explanation of symbols	10
1.2.1 Use of danger information	10
1.2.2 Use of general information	10
1.3 Version information	11
2 Safety instructions	12
2.1 Intended use	12
2.2 Qualified personnel	13
3 Designations and synonyms	14
4 System description	18
4.1 About LioN-X and LioN-Xlight	18
4.2 Device variants	19
4.3 I/O port overview	21
5 Overview of product features	23
5.1 PROFINET product features	23
5.2 I/O port features	26
5.3 Integrated Web server	27
5.4 Security features	28
5.5 Other features	29

6	Assembly and wiring	30
6.1	General information	30
6.2	Outer dimensions	31
6.2.1	LioN-X multiprotocol variants	31
6.2.2	LioN-Xlight variants with PROFINET	33
6.2.3	Notifications	35
6.3	Port assignments	36
6.3.1	Ethernet ports, M12 socket, 4-pin, D-coded	36
6.3.2	Power supply with M12 power L-coded	37
6.3.2.1	IO-Link Master with Class A ports	38
6.3.3	I/O ports as M12 sockets	38
6.3.3.1	IO-Link ports (Class A)	39
7	Starting operation	41
7.1	GSDML file	41
7.2	MAC addresses	41
7.3	State on delivery	42
7.4	Setting the rotary encoding switches	43
7.4.1	PROFINET	46
7.4.2	Factory reset	46
7.5	SNMPv1	46
8	Configuration and operation with SIEMENS TIA Portal®	47
8.1	Assigning a device name and IP address	49
8.2	Configuring the IO-Link channels	51
8.2.1	Deleting the configuration of a specified IO-Link channel	52
8.2.2	Creating an IO-Link channel configuration	53
8.3	Parameterization of the Status/Control Module	56

8.3.1	General Device Settings	57
8.3.2	I/O mapping configuration of Status/Control data	59
8.3.3	General Diagnostic Settings	62
8.3.3.1	Diagnostic settings for modules with IO-Link Class A ports	62
8.4	Parameterization of the I/O ports X1 .. X8	63
8.4.1	Enhanced port parameters	65
8.4.2	Failsafe port parameters for Ch. A in IO-Link mode	69
8.4.3	Standardized port parameters	72
8.5	IO-Link Device Parameterization	80
8.5.1	SIEMENS IO-Link library	80
8.5.1.1	SIEMENS function block FB50001 – write example	82
8.5.1.2	SIEMENS function block FB50001 – read example	84
8.5.2	SIEMENS WRREC and RDREC	86
8.5.2.1	Write sequence	86
8.5.2.2	Read sequence	93
8.5.2.3	Error PDU for the Read/Write sequence	100
8.6	Media Redundancy Protocol (MRP)	102
8.7	Identification & maintenance (I&M)	104
8.7.1	Supported I&M features	104
8.7.1.1	I&M data of the PN-IO Device	104
8.7.1.2	I&M data of the IOL-Master proxy (Status/Control Module)	107
8.7.1.3	I&M data of the IOL-Device proxy	108
8.7.2	Reading and writing I&M data	111
8.7.2.1	I&M Read Record	112
8.7.2.2	I&M Write Record	115
8.8	Fast Start Up (FSU) / Prioritized Startup	116
8.9	Suspend / Resume of IO-Link port operation	118
8.9.1	Automatic tool changer application use case	118
8.9.2	Concept	118
8.9.3	Use cases	120
8.9.4	Suspend and Resume cycle	121
8.9.4.1	Write Record Suspend – port command	121
8.9.4.2	Read Record Suspend – port status	122
8.9.4.3	Write Record Resume – port command	124

8.9.4.4 Read Record Resume – port status	125
--	-----

9 Process data assignment 128

9.1 Process data Status/Control Module, I/O system 1.1	128
9.1.1 Status/Control data with Bit Mapping	130
9.1.1.1 Mode 1	130
9.1.1.2 Mode 2	131
9.1.1.3 Mode 3	131
9.1.1.4 Mode 4	132
9.1.1.5 Mode 5	132
9.1.1.6 PROFINET channel diagnostics mapping	132
9.2 Process data IO-Link ports, Slot 1.2 – 1.9	132

10 Diagnostics 136

10.1 Detailed diagnostics description	136
10.1.1 Error of the system/sensor power supply U_S	136
10.1.2 Error of the actuator power supply U_L	137
10.1.3 Overload/short-circuit of the I/O port sensor supply outputs	138
10.1.4 Overload/short circuit of the I/O port Ch. A as actuator outputs	139
10.1.5 Overload/short circuit of the I/O port Ch. B as actuator outputs	141
10.1.6 IO-Link C/Q error	143
10.1.7 Generic parameter error	144
10.1.8 I/O mapping parameter error	144
10.1.9 Process data mismatch error	145
10.1.10 Force mode diagnostic	145
10.1.11 Internal module error	145
10.2 Table of IO-Link Master diagnostic codes	147
10.3 IO-Link Device diagnostics in PROFINET	149
10.4 Table of IO-Link Device diagnostic codes	150

11 IIoT functionality	153
11.1 MQTT	154
11.1.1 MQTT configuration	154
11.1.2 MQTT topics	157
11.1.2.1 Base topic	157
11.1.2.2 Publish topic	160
11.1.2.3 Command topic (MQTT Subscribe)	165
11.1.3 MQTT configuration - Quick start guide	169
11.1.3.1 MQTT configuration via JSON	169
11.2 OPC UA	171
11.2.1 OPC UA configuration	172
11.2.2 OPC UA address space	174
11.2.3 OPC UA configuration - Quick start guide	175
11.2.3.1 OPC UA configuration via JSON	175
11.3 REST API	177
11.3.1 Standard device information	179
11.3.2 Structure	180
11.3.3 Configuration and forcing	186
11.3.4 Reading and writing ISDU parameters	188
11.3.4.1 Reading ISDU	188
11.3.4.2 Writing ISDU	190
11.3.5 Example: Reading ISDU	192
11.3.6 Example: Writing ISDU	192
11.4 CoAP server	193
11.4.1 CoAP configuration	193
11.4.2 REST API access via CoAP	194
11.4.3 CoAP configuration - Quick start guide	197
11.4.3.1 CoAP configuration via JSON	197
11.5 Syslog	199
11.5.1 Syslog configuration	199
11.5.2 Syslog configuration - Quick start guide	202
11.5.2.1 Syslog configuration via JSON	202
11.6 Network Time Protocol (NTP)	204

11.6.1 NTP configuration	204
11.6.2 NTP configuration - Quick start guide	206
11.6.2.1 NTP configuration via JSON	206
12 The integrated Web server	208
12.1 LioN-X 0980 XSL... variants	209
12.1.1 The Status page	209
12.1.2 The Ports page	210
12.1.3 The System page	211
12.1.4 The User page	213
12.2 LioN-Xlight 0980 LSL... variants	214
12.2.1 The System page	214
13 IODD	216
13.1 IO-Link Device parameters and ISDU requests	216
13.2 Web GUI functionality	217
13.2.1 Port Details page	217
13.2.2 Parameters page	219
13.2.3 IODD Management page	221
14 Technical data	222
14.1 General	223
14.2 PROFINET protocol	224
14.3 Power supply of the module electronics/sensors	225
14.4 Power supply of the actuators	226
14.4.1 IO-Link Class A devices (U_L)	226
14.5 I/O ports Channel A (Pin 4)	226
14.5.1 Configured as digital input, Ch. A (Pin 4)	227
14.5.2 Configured as digital output, Ch. A (Pin 4)	228
14.5.3 Configured as IO-Link port in COM mode, Ch. A	229
14.6 I/O ports Channel B (Pin 2)	230

14.6.1 Configured as a digital input, Ch. B (Pin 2)	230
14.6.2 Configured as a digital output, Ch. B (Pin 2)	231
14.7 LEDs	233
14.8 Data transfer times	236

15 Accessories **238**

1 About this manual

1.1 General information

Please read the assembly and operating instructions in this manual carefully before starting up the modules. Keep the manual where it is accessible to all users.

The texts, figures, diagrams, and examples used in this manual are used exclusively to explain how to operate and apply the modules.

Please contact us if you have any detailed questions on installing and starting up the devices.

Belden Deutschland GmbH
– Lumberg Automation™ –
Im Gewerbepark 2
D-58579 Schalksmühle
Germany
lumberg-automation-support.belden.com
www.lumberg-automation.com
catalog.belden.com

Belden Deutschland GmbH – Lumberg Automation™ – reserves the right to make technical changes or changes to this manual at any time without notice.

1.2 Explanation of symbols

1.2.1 Use of danger information

Danger information is denoted as follows:



Danger: Means that death, serious physical injury or substantial damage to property will occur if the required safety measures are not taken.



Warning: Means that death, serious physical injury or substantial damage to property can occur if the required safety measures are not taken.



Caution: Means that minor physical injury or damage to property can occur if the required safety measures are not taken.

1.2.2 Use of general information

General information is denoted as follows:



Attention: Contains important information on the product, on how to manage the product, or on the respective section of the documentation to which your special attention is being drawn.

1.3 Version information

Version	Created	Changes
1.0	03/2021	
1.1	04/2021	
1.2	05/2021	
1.3	11/2021	Ch. 4.3 Ch. 8.3.2 + 9.1: Default of "Mode 2"
2.0	03/2022	New chapters: Ch. 8.9 ("Suspend / Resume") Ch. 11.6 ("NTP") Ch. 13 ("IODD") New device variants: 0980 XSL 3912-121-007D-01F 0980 XSL 3913-121-007D-01F
2.1	06/2022	Temporarily excluded device variant information for 0980 XSL 3913-121-007D-01F (shipping in 2023)

Table 1: Overview of manual revisions

2 Safety instructions

2.1 Intended use

The products described in this manual are decentralized IO-Link Masters on an Industrial Ethernet Network.

We adhere to all safety standards when developing, producing, testing, and documenting our products. When you adhere to the handling specifications and safety instructions described for the configuration, assembly, and correct operation, there should not normally be any risks for people or equipment.

The modules fulfill the requirements of the EMC guidelines (89/336/EEC, 93/68/EEC and 93/44/EEC) and the low voltage guideline (73/23/EEC).

The IO-Link Masters are designed to be used in the industrial sector. The industrial environment is distinguished by the fact that the consumer is not connected directly to the public low voltage network. Additional measures are required for use in residential areas or in business and commercial sectors.



Attention: This equipment may cause radio interference in residential areas. In this case the operator may be requested to carry out appropriate measures.

The proper and safe operation of this product depends on proper transportation, storage, assembly, and installation, and careful operation.

A completely assembled device housing is required for the proper operation of the IO-Link Masters. Only connect devices that fulfill the requirements of EN 61558-2-4 and EN 61558-2-6 to the IO-Link Masters.

During the configuration, installation, start-up, maintenance, and testing of the devices, adhere to the safety and accident-prevention guidelines for the specific application.

Only install cables and accessories that fulfill the requirements and regulations for safety, electromagnetic compatibility, and, where applicable, telecommunication end devices, as well as the specification information.

Information on which cables and accessories are permitted for the installation can be obtained from Lumberg Automation™ or is contained in this manual.

2.2 Qualified personnel

The configuration, installation, start-up, maintenance, and testing of the devices may only be performed by a qualified electrician who is familiar with the safety standards of the automation technology.

The personnel requirements are based on the requirement profiles described by ZVEI, VDMA, or equivalent organizations.

Only electricians who are familiar with the content of this manual are authorized to install and maintain the devices described. These are persons who

- ▶ based on their technical training, knowledge, and experience, and their knowledge of the pertinent standards, can evaluate the work to be carried out and identify any potential risks or
- ▶ based on working for several years in a related sector, have the same level of knowledge as they would have from the relevant technical training.

Only Belden Deutschland GmbH – Lumberg Automation™ – is permitted to make changes to the hardware or software of the products that go beyond the scope of this manual.



Warning: Making unqualified changes to the hardware or software, or non-adherence to the warning information contained in this manual, can result in serious personal injury or damage to equipment.



Attention: Belden accepts no liability for any damage caused by unqualified personnel or improper use. This automatically voids the warranty.

3 Designations and synonyms

AOI	Add-On Instruction
API	Application Programming Interface
BF	Bus Fault LED
Big Endian	Data format with High-B on first place (PROFINET and IO-Link)
BUI	Back-Up Inconsistency (EIP diagnostics)
CC	CC-Link IE Field
C/Q	I/O port pin 4 mode, IO-Link communication/switching signal
Ch. A	Channel A (Pin 4) of I/O port
Ch. B	Channel B (Pin 2) of I/O port
CIP	Common Industrial Protocol (media independent protocol)
Class A	IO-Link port specification (Class A)
Class B	IO-Link port specification (Class B)
CoAP	Constrained Application Protocol
CSP+	Control & Communication System Profile Plus
DCP	Discovery and Configuration Protocol
DevCom	Device Communicating (EIP diagnostics)
DevErr	Device Error (EIP diagnostics)
DI	Digital Input
DIA	Diagnostic LED
DO	Digital Output
DIO	Digital Input/Output
DTO	Device Temperature Overrun (EIP diagnostics)
DTU	Device Temperature Underrun (EIP diagnostics)
DUT	Device under test
EIP	EtherNet/IP
ERP	Enterprise Resource Planning system
ETH	ETHERNET

3 Designations and synonyms

FE	Functional Earth
FME	Force Mode Enabled (EIP diagnostics)
FS	Functional Safety
FSU	Fast Start-Up
GSDML	General Station Description Markup Language
High-B	High-Byte
ICE	IO-Link port COM Error (EIP diagnostics)
ICT	Invalid Cycle Time (EIP diagnostics)
IDE	IO-Link port Device Error (EIP diagnostics)
IDN	IO-Link port Device Notification (EIP diagnostics)
IDW	IO-Link port Device Warning (EIP diagnostics)
IIoT	Industrial Internet of Things
ILE	Input process data Length Error (EIP diagnostics)
IME	Internal Module Error (EIP diagnostics)
I/O	Input / Output
I/O port	X1 .. X8
I/O port pin 2	Channel B of I/O ports
I/O port pin 4 (C/Q)	Channel A of I/O ports
IODD	I/O Device Description
IOL or IO-L	IO-Link
I/Q	I/O port pin 2 mode, Digital Input/switching signal
ISDU	Indexed Service Data Unit
IVE	IO-Link port Validation Error (EIP diagnostics)
I&M	Identification & Maintenance
JSON	JavaScript Object Notation (platform independent data format)
L+	I/O port pin 1, sensor power supply
LioN-X 60	LioN-X variants with a width of 60mm
Little Endian	Data format with Low-B on first place (Ethernet/IP)
LLDP	Link Layer Discovery Protocol
Low-B	Low-Byte

LSB	Least Significant Bit
LVA	Low Voltage Actuator Supply (EIP diagnostics)
LVS	Low Voltage System/Sensor Supply (EIP diagnostics)
MIB	Management Information Base
MP	Multi Protocol: PROFINET + EtherNet/IP + EtherCAT® + Modbus TCP (+ CC-Link IE Field Basic)
MQTT	Message Queuing Telemetry Transport (open networking protocol)
MSB	Most Significant Bit
M12	Metric thread according to DIN 13-1 with 12 mm diameter
NTP	Network Time Protocol
OLE	Output process data Length Error (EIP diagnostics)
OPC UA	Open Platform Communications Unified Architecture (platform independent, service-oriented architecture)
PLC	Programmable Logic Controller
PN	PROFINET
PWR	Power
REST	REpresentational State Transfer
RFC	Request for Comments
RPI	Requested Packet Interval
RWr	Word data input as seen from the master station (CC-Link)
RWw	Word data output as seen from the master station (CC-Link)
RX	Bit data input as seen from the master station (CC-Link)
RY	Bit data output as seen from the master station (CC-Link)
SCA	Short Circuit Actuator/U _L /U _{AUX} (EIP diagnostics)
SCS	Short Circuit Sensor (EIP diagnostics)
SNMP	Simple Network Management Protocol
SP	Single Protocol (PROFINET, EtherNet/IP, EtherCAT®, Modbus TCP or CC-Link IE Field Basic)
SPE	Startup Parameterization Error (EIP diagnostics)
U _{AUX}	U _{Auxiliary} , supply voltage for the load circuit (Actuator supply on Class B ports of Class A/B IO-Link Master)

3 Designations and synonyms

UDP	User Datagram Protocol
UDT	User-Defined Data Types
UINT8	Byte in PLC (IB, QB)
UINT16	Unsigned integer with 16 bits or word in PLC (IW, QW)
U_L	U_{Load} , supply voltage for the load circuit (Actuator supply on Class A IO-Link Master)
UL	Underwriters Laboratories Inc. (certification company)
UTC	Coordinated Universal Time (Temps Universel Coordonné)

Table 2: Designations and synonyms

4 System description

The LioN modules (Lumberg Automation™ Input/Output Network) function as the interface in an industrial Ethernet system: A central controller on the management level is able to communicate with the decentralized sensors and actuators on the field level. The line or ring topologies for which LioN modules can be used ensure not only reliable data communication but also significantly reduce the number of cables required and thus also the costs for and maintenance. They additionally enable easy and quick extension.

4.1 About LioN-X and LioN-Xlight

The LioN-X and LioN-Xlight variants convert standard input, standard output or IO-Link signals from sensors & actuators into an industrial Ethernet protocol (PROFINET, EtherNet/IP, EtherCAT®, Modbus TCP, CC-Link IE Field Basic) and/or into a cloud protocol (REST API, OPC UA, MQTT). For the first time, there is now Syslog on board. The robust 8 port housing design allows the use even in harsh environments where e.g. weld field immunity, high temperature ranges or protection class IP67 & IP69K are needed. There are also LioN-Xlight single protocol versions available with a limited feature set at a highly attractive price point.

Use all benefits of the Lumberg Automation™ product solution by additionally downloading the configuration tool *LioN-Management Suite V2.0* from www.belden.com to enable e.g. a fast and easy parameterization of the connected IO-Link devices via the embedded IODD interpreter.

4.2 Device variants

The following variants are available in the LioN-X and the LioN-Xlight family:

Article number	Product designation	Description	I/O port functionality
935700001	0980 XSL 3912-121-007D-00F	LioN-X M12-60 mm, IO-Link Master Multiprotocol (PN, EIP, EC, MB) Security	8 x IO-Link Class A
935700002	0980 XSL 3912-121-007D-01F	LioN-X M12-60 mm, IO-Link Master Multiprotocol (PN, EIP, EC, MB, CC) Security	8 x IO-Link Class A
935701001	0980 LSL 3011-121-0006-001	LioN-Xlight M12-60 mm, IO-Link Master PROFINET	8 x IO-Link Class A
935702001	0980 LSL 3010-121-0006-001	LioN-Xlight M12-60 mm, IO-Link Master PROFINET	4 x IO-Link Class A + 8 x DI
935701002	0980 LSL 3111-121-0006-002	LioN-Xlight M12-60 mm, IO-Link Master EtherNet/IP	8 x IO-Link Class A
935702002	0980 LSL 3110-121-0006-002	LioN-Xlight M12-60 mm, IO-Link Master EtherNet/IP	4 x IO-Link Class A + 8 x DI
935701003	0980 LSL 3211-121-0006-004	LioN-Xlight M12-60 mm, IO-Link Master EtherCAT®	8 x IO-Link Class A
935702003	0980 LSL 3210-121-0006-004	LioN-Xlight M12-60 mm, IO-Link Master EtherCAT®	4 x IO-Link Class A + 8 x DI

Article number	Product designation	Description	I/O port functionality
935701004	0980 LSL 3311-121-0006-008	LioN-Xlight M12-60 mm, IO-Link Master Modbus TCP	8 x IO-Link Class A
935702004	0980 LSL 3310-121-0006-008	LioN-Xlight M12-60 mm, IO-Link Master Modbus TCP	4 x IO-Link Class A + 8 x DI
935701005	0980 LSL 3411-121-0006-010	LioN-Xlight M12-60 mm, IO-Link Master CC-Link IE Field Basic	8 x IO-Link Class A
935702005	0980 LSL 3410-121-0006-010	LioN-Xlight M12-60 mm, IO-Link Master CC-Link IE Field Basic	4 x IO-Link Class A + 8 x DI

Table 3: Overview of LioN-X and LioN-Xlight variants

4.3 I/O port overview

The following tables show the main I/O port differences of the LioN-X IO-Link Master family. Pin 4 and Pin 2 of the I/O ports can be configured partly to IO-Link, Digital Input or Digital Output.

LioN-X Class A IO-Link ports

Device variant	Port	Pin 1 U _S	Pin 4 / Ch. A (C/Q)				Pin 2 / Ch. B (I/Q)	
0980 XSL 3x12...	Info:	–	Class A	Type 1	Supply by U _S ¹⁾	Supply by U _L ²⁾	Type 1	Supply by U _L ²⁾
	X8:	Out (4 A)	IOL	DI	DO (0.5 A)	DO (2 A)	DI	DO (2 A)
	X7:	Out (4 A)	IOL	DI	DO (0.5 A)	DO (2 A)	DI	DO (2 A)
	X6:	Out (4 A)	IOL	DI	DO (0.5 A)	DO (2 A)	DI	DO (2 A)
	X5:	Out (4 A)	IOL	DI	DO (0.5 A)	DO (2 A)	DI	DO (2 A)
	X4:	Out (4 A)	IOL	DI	DO (0.5 A)	DO (2 A)	DI	DO (2 A)
	X3:	Out (4 A)	IOL	DI	DO (0.5 A)	DO (2 A)	DI	DO (2 A)
	X2:	Out (4 A)	IOL	DI	DO (0.5 A)	DO (2 A)	DI	DO (2 A)
X1:	Out (4 A)	IOL	DI	DO (0.5 A)	DO (2 A)	DI	DO (2 A)	

Table 4: Port configuration of 0980 XSL 3x12... variants

¹⁾ DO switch mode configured as "Push-Pull" (description in the configuration chapters).

²⁾ DO switch mode configured as "High-Side" (description in the configuration chapters).

LioN-Xlight Class A IO-Link ports

Device variant	Port	Pin 1 U _S	Pin 4 / Ch. A (C/Q)			Pin 2 / Ch. B (I/Q)
0980 LSL 3x11...	Info:	–	Class A	Type 1	Supply by U _S ¹⁾	Type 1
	X8:	Out (2 A)	IOL	DI	DO (0.5 A*)	DI
	X7:	Out (2 A)	IOL	DI	DO (0.5 A*)	DI
	X6:	Out (2 A)	IOL	DI	DO (0.5 A*)	DI
	X5:	Out (2 A)	IOL	DI	DO (0.5 A*)	DI
	X4:	Out (2 A)	IOL	DI	DO (0.5 A*)	DI
	X3:	Out (2 A)	IOL	DI	DO (0.5 A*)	DI
	X2:	Out (2 A)	IOL	DI	DO (0.5 A*)	DI
X1:	Out (2 A)	IOL	DI	DO (0.5 A*)	DI	

Table 5: Port configuration of 0980 LSL 3x11... variants

Device variant	Port	Pin 1 U _S	Pin 4 / Ch. A (C/Q)			Pin 2 / Ch. B (I/Q)
0980 LSL 3x10...	Info:	–	Class A	Type 1	Supply by U _S ¹⁾	Type 1
	X8:	Out (0.7 A)	–	DI	–	DI
	X7:	Out (0.7 A)	–	DI	–	DI
	X6:	Out (0.7 A)	–	DI	–	DI
	X5:	Out (0.7 A)	–	DI	–	DI
	X4:	Out (2 A)	IOL	DI	DO (0.5 A*)	DI
	X3:	Out (2 A)	IOL	DI	DO (0.5 A*)	DI
	X2:	Out (2 A)	IOL	DI	DO (0.5 A*)	DI
	X1:	Out (2 A)	IOL	DI	DO (0.5 A*)	DI

Table 6: Port configuration of 0980 LSL 3x10... variants

¹⁾ With DO Switch Mode configured as "Push-Pull" (see description in the configuration chapters).

* For **UL applications**: Max. 0.25 A DO.

5 Overview of product features

5.1 PROFINET product features

Data connection

The connection option provided by LioN-X is the widely-used M12 connector with D-coding for the PROFINET IO network.

The connectors are also color-coded to prevent the ports from being mixed up.

Data transmission rates

Support of 100 Mbit/s with auto crossover and auto negotiation corresponding to IEEE 802.3.

PROFINET RT IO Device

The LioN-X variants support PROFINET RT (real-time). This allows the transmission of time sensitive process data between network components in real-time communication.

PROFINET specification V2.35, Conformance Class C (CC-C)

The LioN-X variants comply with the PROFINET specification V2.35 and meet the requirements of Conformance Class C (CC-C) for the integrated switch. This means the device can be used in PROFINET IRT networks.

Integrated switch

The integrated Ethernet switch with Conformance Class C (CC-C) has two PROFINET ports and thus supports the establishment of a line or ring topology for the PROFINET IO network.

Media Redundancy Protocol

The additionally implemented Media Redundancy Protocol (MRP) enables the design of a highly available network infrastructure.

Fast Start-Up (FSU)

Fast Start-Up is an accelerated start-up process that enables Lion-X devices to start communicating on a PROFINET network after a very short time. This makes a faster tool change possible, for example. Thanks to the FSU feature, the network is ready to communicate in less than 2200 ms.¹

Shared Device

With the shared device functionality, two controllers can access the same I/O device via a PROFINET interface. This option is done by copying the configuration of the I/O device into the first and second controller and assigning it to the second controller as shared device. Every sub slot with I/O data can be assigned to **one** of the two PLCs which share the I/O data of the I/O device.

DCP

The devices use the DCP protocol to automatically assign IP addresses.

Net Load Class III

The devices offer advanced robustness against net load according to Net Load Class III.

LLDP

The LLDP protocol is used to detect devices in the vicinity (neighborhood detection).

SNMPv1

The SNMPv1 protocol (according PROFINET standard V2.35) handles network component monitoring and communication between Master and Device (cannot be operated stand-alone).

Alarm and diagnostic messages

The modules support extended PROFINET alarm and diagnostic messages.

¹ Measured according to the specification: Internal switch is able to forward telegrams.

I&M functions

Identification and maintenance data (I&M) means information stored on the module. The identification data consist of manufacturer details for the module and can only be read. The maintenance data consist of system specific details created during the course of configuration. The modules can be uniquely identified online via the I&M data.

The device supports I&M data related to the PNO 2.832 standard (IO-Link integration for PROFINET, Edition 2):

- ▶ I&M0 ... I&M3 for the interface module (access slot, sub-slot 0x8000)
- ▶ I&M0 for the IO-Link Master proxy
- ▶ I&M0 and I&M5 for the IO-Link Device proxies

GSDML-based configuration and parameterization of the I/O ports

The GSDML offers the option of configuring and parameterizing the I/O ports on the master devices within an engineering tool of a PLC.

5.2 I/O port features

IO-Link specification.

LioN-X is ready for IO-Link specification v1.1.3.

8 x IO-Link Master ports

Depending on the variant, the IO-Link Master has 4 IO-Link Class A, or 8 IO-Link Class A ports with an additional digital input and optional output (0980 XSL 3x13... variants) on pin 2 of the I/O port. For detailed information see chapter [I/O port overview](#) on page 21.



Warning: If devices with electric isolation and devices without electric isolation are used within the same system, the electric isolation of all connected devices is annulled.

IO-Link port connections

The IO-Link port connection option provided by LioN-X devices is the 5-pin M12 connector. Pin 5 is not assigned for IO-Link Class A ports.

Validation & Backup

The Validation & Backup function checks if the right device is connected and stores the parameters of the IO-Link Device. The function thus gives you an easy option for replacing the IO-Link Device.

This is possible as of IO-Link specification V1.1 and only if the IO-Link Device **and** the IO-Link Master support the function.

IO-Link Device parameterization

IO-Link Device parameterization in a PROFINET network is possible via the Siemens IO_LINK_DEVICE function block (FB50001) for Siemens TIA Portal®.

LED

The status of the ports is visible by the color of the matching LEDs and their flash pattern. For details on the meanings of the LED colors, please see section [LEDs](#) on page 233.

5.3 Integrated Web server

Network parameter display

Get an overview of network parameters such as the IP address, subnet mask and gateway.

Displaying diagnostics

View diagnostics via the integrated Web server.

User management

Use the integrated Web server for convenient management of all users.

IO-Link Device parameters

Reading and writing of IO-Link Device parameters is supported. The system command Store parameters is needed after parameter writing, to take over the changed parameter into the IO-Link Master backup memory when enabled.

5.4 Security features

Firmware signature

All official firmware update packages contain a signature which prevents the system against manipulated firmware updates.

Syslog

The LioN-X multiprotocol variants support the traceability of messages centrally managed and logged via Syslog.

User manager

The Web server provides a user manager to protect the Web interface against unauthorized access. You can manage the allowed users by different access levels “Admin” or “Write”.

Default user settings:

User: admin

Password: private



Attention: Change the default settings to protect the device against unauthorized access.

5.5 Other features

Interface protection

The devices have reverse polarity, short-circuit and overload protection for all interfaces.

For more details, see section [Port assignments](#) on page 36.

Failsafe

The devices support a failsafe function. This allows you to define the behavior of every single channel configured as an output in the case of a loss of the PLC communication.

Industrial Internet of Things

LioN-X is industry 4.0 ready and supports the integration in IIoT networks via REST API and the IIoT-relevant protocols MQTT, OPC UA and CoAP.

Color-coded connectors

The colored connectors help you avoid confusion in your cabling.

IP protection classes: IP65 / IP67 / IP69K



The IP protection class describes environmental influences that the devices can be exposed to without risk and without suffering damage, or causing a risk for the user.

The whole LioN-X family offers IP65, IP67 and IP69K.

6 Assembly and wiring

6.1 General information

Mount the device on a flat surface using 2 screws (M4x 25/30). The torque required here is 1 Nm. Use washers for all fastening methods as per DIN 125.

-  **Attention:** The devices have a ground connection with an M4 thread for the conduction of interference currents and the EMC immunity. This is labeled with the symbol for the ground and the designation "FE"
-  **Attention:** Use a low-impedance connection to connect the device to the reference ground. When using a grounded mounting surface, you can make the connection directly via the fixing screws.
-  **Attention:** If the mounting surface is ground-free, use a ground strap or a suitable FE line (FE = Functional Earth). Use an M4 screw to connect the ground strap or the FE line to the ground point and if possible put a washer and a toothed washer below the fixing screw.

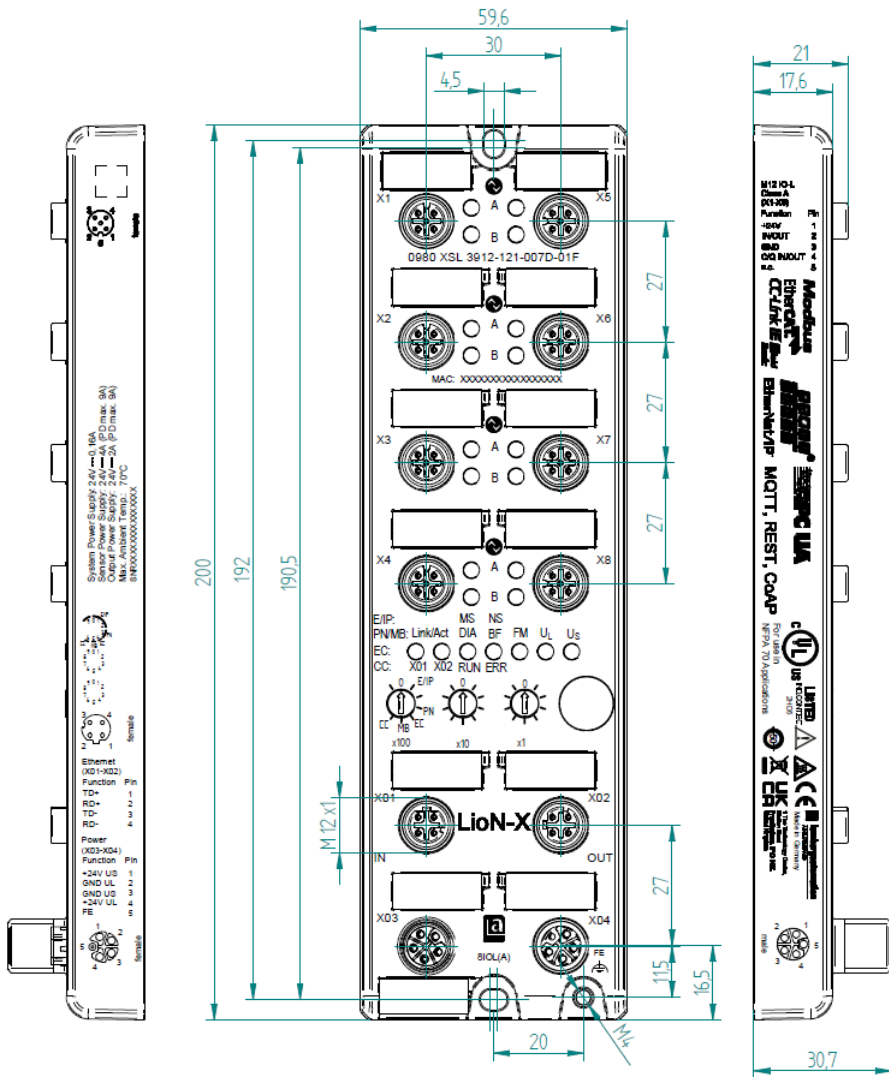

Figure 2: 0980 XSL 3912-121-007D-01F

6.2.2 Lion-Xlight variants with PROFINET

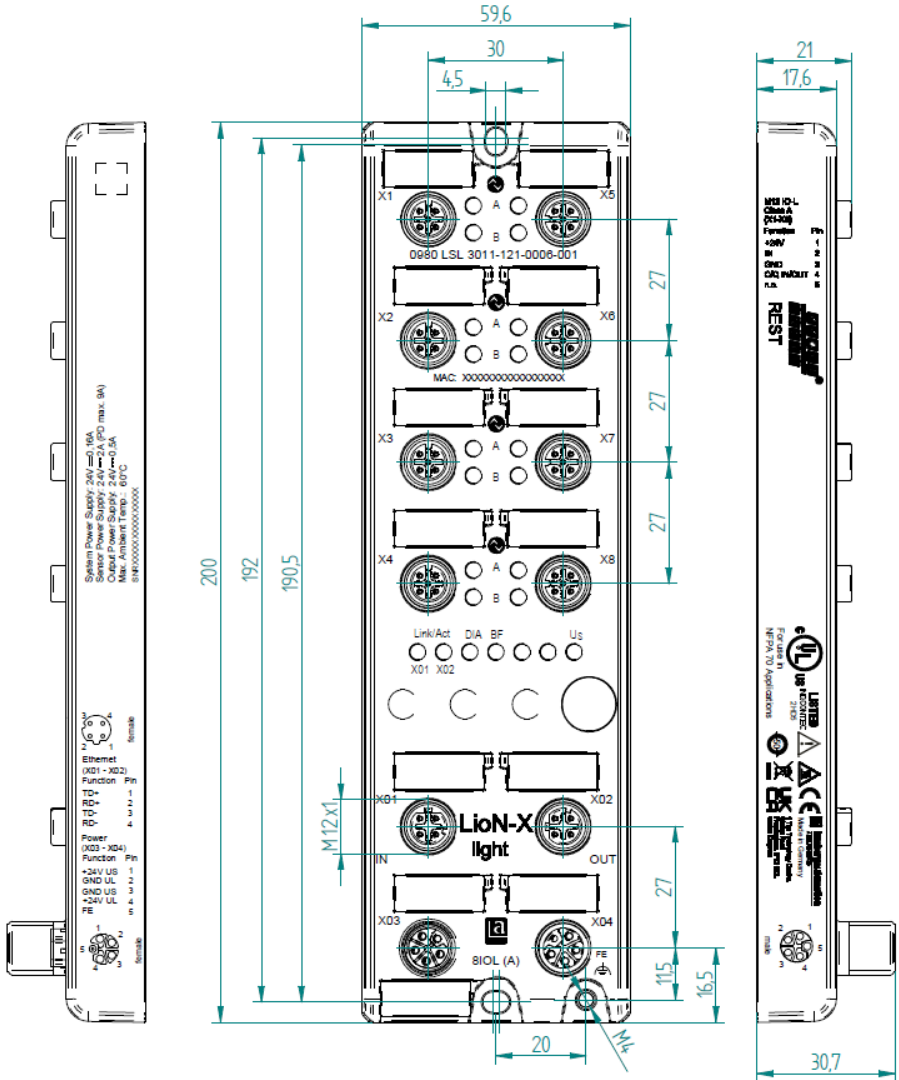

Figure 3: 0980 LSL 3011-121-0006-001

6.2.3 Notifications

**Attention:**

For **UL applications**, be sure to use a UL-certified cable with a suitable evaluation to connect the devices (CYJV or PVVA). To program the control, please refer to the OEM information, and only use suitable accessories.

Only approved for interior use. Please note the maximum elevation of 2000 meters. Approved up to a maximum soiling level of 2.



Warning: Terminals, housings field-wired terminal boxes or components can exceed temperatures of +60 °C (140 °F).



Warning: For **UL applications** at a maximum ambient temperature of +70 °C (158 °F):

Use temperature-resistant cables with heat resistance up to at least +125 °C (257 °F) for all LioN-X and LioN-Xlight variants.



Warning: Observe the following maximum output power for the sensor supply of Class A devices:

Max. 4.0 A per port; for **UL applications** max. 5 A for every port pair X1/X2, X3/X4, X5/X6, X7/X8; max. 9.0 A in total (with derating) for the whole port group X1 .. X8.

6.3 Port assignments

All the contact arrangements shown in this chapter show the frontal view of the connection area for the connectors.

6.3.1 Ethernet ports, M12 socket, 4-pin, D-coded

Color coding: green

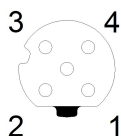

Figure 5: Schematic drawing, ports X01, X02

Port	Pin	Signal	Function
Ethernet Ports X01, X02	1	TD+	Transmit data plus
	2	RD+	Receive data plus
	3	TD-	Transmit data minus
	4	RD-	Receive data minus

Table 7: Assignment of ports X01, X02



Caution: Risk of destruction! Never connect the power supply to the data cables.

6.3.2 Power supply with M12 power L-coded

Color coding: gray

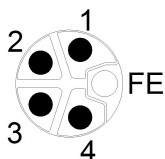

Figure 6: Schematic diagram of the M12 L-coding (connector X03 for Power In)

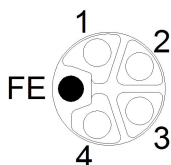

Figure 7: Schematic diagram of the M12 L-coding (socket X04 for Power Out)

6.3.2.1 IO-Link Master with Class A ports

Power supply	Pin	Signal	Function
	1	U_S (+24 V)	Sensor/system power supply
	2	GND_ U_L	Ground/reference potential U_L
	3	GND_ U_S	Ground/reference potential U_S ¹
	4	U_L (+24 V)	Load supply (NOT electrically isolated to U_S internally in device)
	5	FE	Functional ground

Table 8: Power supply with M12-Power Class A

i **Attention:** Only use power supply units for the system/sensor and actuator supply that correspond to PELV (Protective Extra Low Voltage) or SELV (Safety Extra Low Voltage). Power supplies according to EN 61558-2-6 (transformers) or EN 60950-1 (switching power supply units) fulfill these requirements.

6.3.3 I/O ports as M12 sockets

Color coding: black

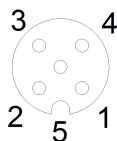

Figure 8: Schematic drawing I/O port as M12 socket IO-Link

² U_L and U_S ground connected in device

6.3.3.1 IO-Link ports (Class A)

0980 XSL 3x12-121...	Pin	Signal	Function
IO-Link Class A, ports X1 ... X8	1	+24 V	power supply +24 V
	2	IN/OUT	Ch. B: Digital input or digital output
	3	GND	Ground/reference potential
	4	C/Q	Ch. A: IO-Link data communication, digital input or digital output
	5	n.c.	not connected
0980 LSL 3x11-121...	Pin	Signal	Function
IO-Link Class A, ports X1 ... X8	1	+24 V	power supply +24 V
	2	IN	Ch. B: Digital input
	3	GND	Ground/reference potential
	4	C/Q	Ch. A: IO-Link data communication, digital input or digital output
	5	n.c.	not connected
0980 LSL 3x10-121...	Pin	Signal	Function
IO-Link Class A, ports X1 ... X4	1	+24 V	power supply +24 V
	2	IN	Ch. B: Digital input
	3	GND	Ground/reference potential
	4	C/Q	Ch. A: IO-Link data communication, digital input or digital output
	5	n.c.	not connected
Digital Input, ports X5 ... X8	1	+24 V	power supply +24 V
	2	IN	Ch. B: Digital input
	3	GND	Ground/reference potential
	4	IN	Ch. A: Digital input
	5	n.c.	not connected

Table 9: I/O ports as IO-Link Class A

Used signal names compared to the IO-Link specification conventions:

Pin	LioN-X	IO-Link specification	Comment
1	+24 V	L+	Supplied by U _S
2	IN/OUT	I/Q	
	+24 V AUX/OUT	2L	Supplied by U _{AUX}
3	GND	L-	
4	C/Q IN/OUT	C/Q	
5	GND AUX	2M	

7 Starting operation

7.1 GSDML file

A GSD file in XML format is required to configure the LioN-X and LioN-Xlight variants. All device variants are grouped in a single GSDML file. The file can be downloaded from the product pages on our online catalog: catalog.belden.com

On request, the GSDML file is also sent by the support team.

The GSDML file and the associated bitmap files are grouped together in an archive file named **GSDML-V2.35-BeldenDeutschland-LioN-X-yyyymmdd.xml**.

yyyymmdd stands for the date on which the file was issued.

Download this file and unpack it.

In Siemens TIA Portal® you create a new project and open the hardware manager under **Configure a device**. Under the menu command **Options > Manage general station description files (GSD)** the GSD file is installed by defining the file path.

The LioN-X and LioN-Xlight variants are then available in the hardware catalog.

7.2 MAC addresses

Every device has three unique assigned MAC addresses that cannot be changed by the user. The first assigned MAC address is printed onto the device.

7.3 State on delivery

PROFINET parameters in state on delivery or after a factory reset:

PROFINET name:	Name not assigned
IP address:	0.0.0.0
Subnet mask:	0.0.0.0
Device designations:	0980 XSL 3912-121-007D-00F 0980 XSL 3912-121-007D-01F 0980 LSL 3011-121-0006-001 0980 LSL 3010-121-0006-001
Vendor ID:	0x016a
Device ID:	0x0400

7.4 Setting the rotary encoding switches



Attention: Only applicable for LioN-X multiprotocol variants; not applicable for LioN-Xlight variants.

The LioN-X multiprotocol variants allow you to select different protocols for communication within an industrial Ethernet system. In this way the IO-Link Masters with multiprotocol function can be integrated into different networks without it being necessary to purchase products specific for each protocol. This technology also gives you the option to use the same IOL-Master in different environments.

Using rotary encoding switches at the lower front of the devices, you can easily and conveniently set both the protocol and the address of the device, if the protocol to be used supports this. Once you have made a protocol selection and started the cyclical communication, the device stores this setting permanently and uses the selected protocol from this point on. To use another supported protocol with this device, perform a factory reset.

The following LioN-X IO-Link Master variants support multiprotocol application for the protocols EtherNet/IP (E/IP), PROFINET (P), EtherCAT® (EC) and Modbus TCP (MB):

► 0980 XSL 3912-121-007D-00F

The following LioN-X IO-Link Master variants additionally provide the protocol CC-Link IE Field Basic (CC):

► 0980 XSL 3912-121-007D-01F

The multiprotocol devices have a total of three rotary encoding switches. With the first rotary encoding switch (x100) you set the protocol by using the corresponding switch position. Additionally, x100 is used to set the third last digit of the IP address for EIP.

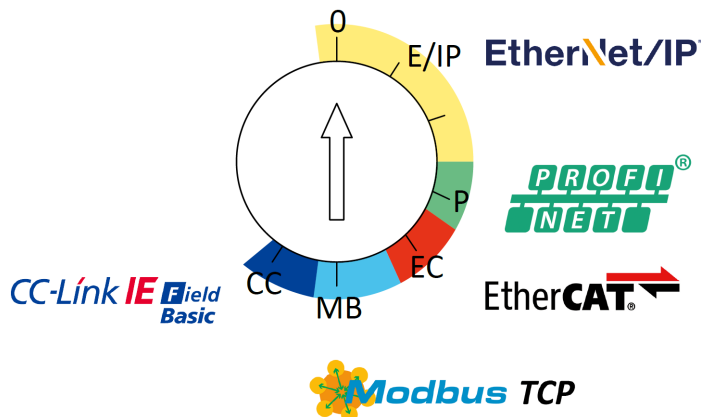

With the other rotary encoding switches (x10 / x1), you set the last two digits of the IP address when you are using EtherNet/IP, Modbus TCP or CC-Link IE Field Basic.

Protocol	x100	x10	x1
EtherNet/IP	0-2	0-9	0-9
PROFINET	P	–	–
EtherCAT®	EC	–	–
Modbus TCP	MB	0-9	0-9
CC-Link IE Field	CC	0-9	0-9

Table 10: Assignment of the rotary encoding switches for each protocol

The setting you make to select a protocol is described detailed in the protocol-specific sections.

In delivery state no protocol settings are stored in the device. In this case only the desired protocol has to be chosen. To take over a changed rotary encoding switch setting (protocol setting), a power cycle or “Reset” from the Web interface is necessary.

Once you have set the protocol using the rotary encoding switches, the device stores this setting when it starts in cyclic communication. Changing the protocol using the rotary encoding switch is no longer possible after this

point. The device will always start using the stored protocol from that point on. The IP address can be changed depending on the selected protocol.

To change the protocol, carry out a factory reset. In this way you restore the factory settings of the respective device. How you perform the factory reset for your device is described in chapter [Factory reset](#) on page 46.

If you position the rotary encoding switch in a manner that is invalid, the device signals this to you with a blink code (the BF/MS LED blinks in red three times).

7.4.1 PROFINET

If you decide to use PROFINET, set the first rotary encoding switch to the value of "P".

7.4.2 Factory reset

A factory reset restores the original factory settings and thus resets the changes and settings you have made up to that point. It also resets the protocol selection. To perform a factory reset, set the first rotary encoding switch (x100) to 9, the second (x10) to 7, and the third (x1) also to 9.

Afterwards perform a power cycle and wait 10 seconds due to internal memory write processes.

During the factory reset, the U_S LED is blinking red. After the internal memory write processes have finished, the U_S LED returns to display static green or red light, in dependency of the actual U_S voltage.

	x100	x10	x1
Factory Reset	9	7	9

Follow the steps from section [Setting the rotary encoding switches](#) on page 43 again to select a new protocol.

For performing a factory reset via software configuration, see chapter [OPC UA configuration](#) on page 172 and the configuration section.

7.5 SNMPv1

The PROFINET IO-Link Master supports SNMP objects required by the PROFINET specification as per protocol standard SNMPv1. These include objects from RFC 1213 MIB-II (System Group and Interfaces Group) and the LLDP MIB.

Passwords:

- ▶ Read Community: public
- ▶ Write Community: private

8 Configuration and operation with SIEMENS TIA Portal®

i Attention: The displayed examples of SIEMENS TIA Portal® have been made with TIA V15.

After installing the GSDML files for the LioN-X PROFINET variants, they are available in the hardware catalog under **Other field devices > PROFINET IO > IO > Belden Deutschland GmbH - Lumberg Automation > Lumberg Automation LioN-X**.

1. First, configure the TIA Portal® project and the control system in the usual way. Assign an IP address and subnet mask for the PROFINET port of the control unit.
2. Then choose the desired device from the Hardware catalog:

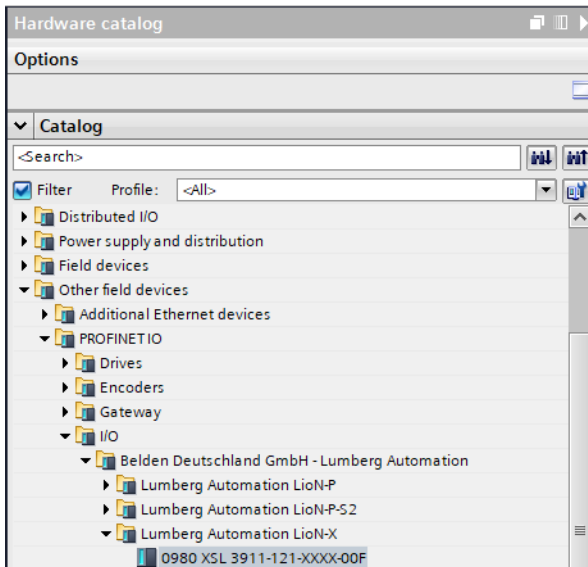

Figure 9: TIA Portal® Hardware catalog

- Click on the article designations of the modules in the hardware catalog and drag and drop the desired device into the network view:

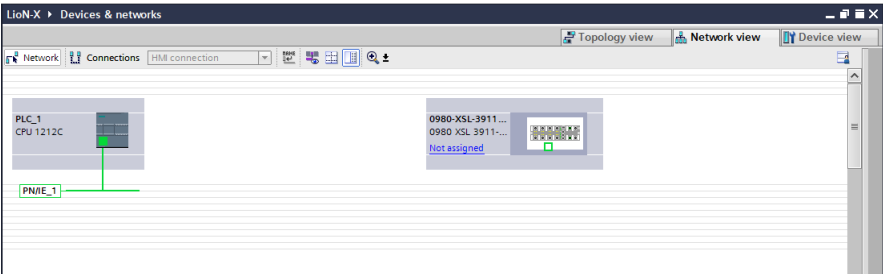

Figure 10: Network view

- Assign the device to the PROFINET network:

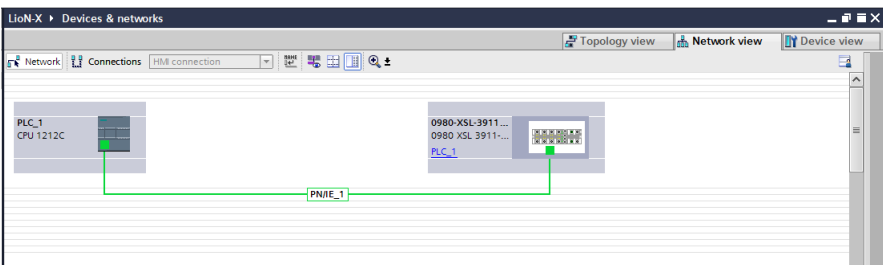

Figure 11: Assign device

- Switch to the device configuration view and select the device to display configuration options:

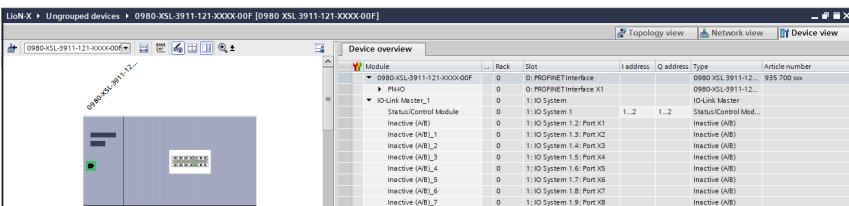

Figure 12: Device configuration

8.1 Assigning a device name and IP address

PROFINET IO devices are addressed on PROFINET via a unique device name. This can be freely assigned by the user, but may only be used once on the network.

1. A click on the device icon or on the first line of the **Device overview** opens the settings for **PROFINET interface > Ethernet addresses**:

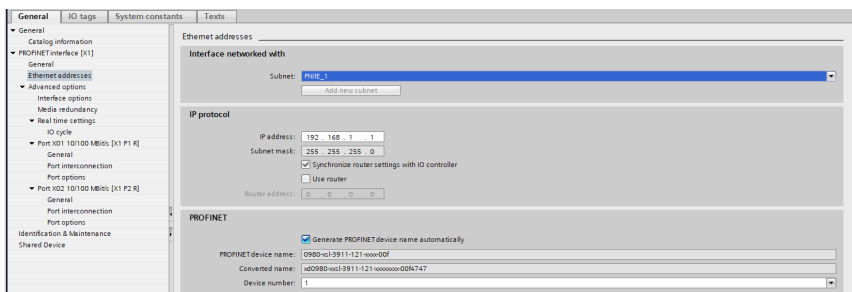

Figure 13: ETHERNET addresses

2. Check that the control unit and the I/O device are on the same Ethernet Subnet.
3. Accept the default settings for IP address and device name or change them if desired.
4. For a correctly working setup, the chosen device name must be programmed online in the I/O device. When the HW is already installed, you can easily change to online mode. The new I/O device should already be accessible via PROFINET:

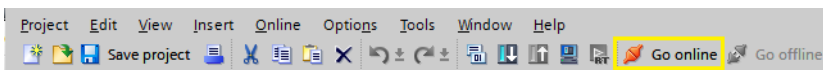

Figure 14: Go online

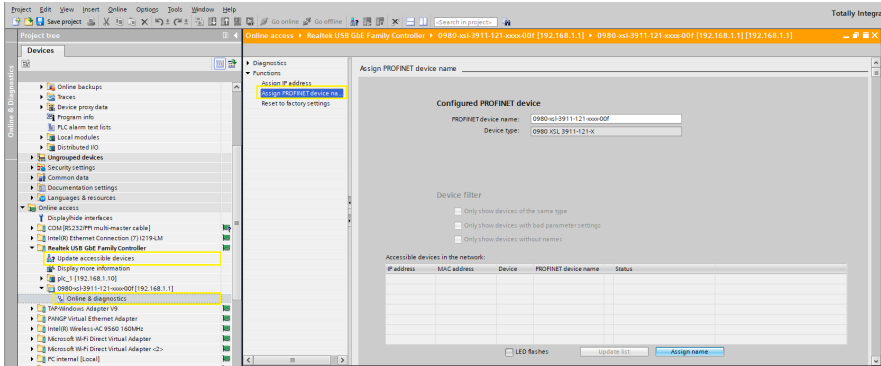

Figure 15: Online mode

5. Enter the same device name as configured in the offline project:

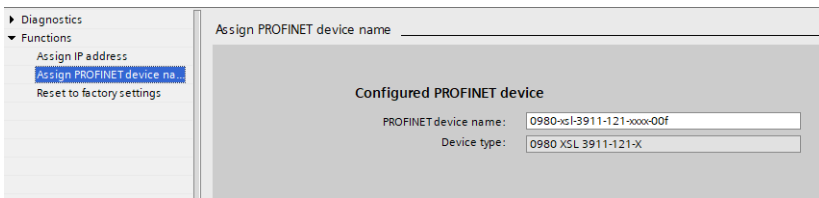

Figure 16: Assign device name

8.2 Configuring the IO-Link channels

By default, all channels are pre-configured as digital input.

Device overview							
Module	...	Rack	Slot	I address	Q address	Type	Article number
0980-XSL-3912-121-007D		0	0: PROFINET Interface			0980-XSL-3912-121-007...	935700001
▶ PN-IO		0	0: PROFINET Interface X1			0980-XSL-3912-121-007D	
▼ IO-Link Master_1		0	1: IO System 1.			IO-Link Master	
Status/Control Module		0	1: IO System 1. 1	1...2	1...2	Status/Control Module	
Digital In (A) / Digital (B)		0	1: IO System 1. 2: Port X1	68		Digital In (A) / Digital (B)	
Digital In (A) / Digital (B)_1		0	1: IO System 1. 3: Port X2	69		Digital In (A) / Digital (B)	
Digital In (A) / Digital (B)_2		0	1: IO System 1. 4: Port X3	70		Digital In (A) / Digital (B)	
Digital In (A) / Digital (B)_3		0	1: IO System 1. 5: Port X4	71		Digital In (A) / Digital (B)	
Digital In (A) / Digital (B)_4		0	1: IO System 1. 6: Port X5	72		Digital In (A) / Digital (B)	
Digital In (A) / Digital (B)_5		0	1: IO System 1. 7: Port X6	73		Digital In (A) / Digital (B)	
Digital In (A) / Digital (B)_6		0	1: IO System 1. 8: Port X7	74		Digital In (A) / Digital (B)	
Digital In (A) / Digital (B)_7		0	1: IO System 1. 9: Port X8	75		Digital In (A) / Digital (B)	

Figure 17: Channels pre-configuration

The configurations of the IO-Link channels (C/Q or Ch. A/Pin 4 of the I/O port) in the sub-slots 2 - 9 (port X1 of the device is equivalent to sub-slot 2, ..., port X8 of the device is equivalent to sub-slot 9) are flexibly definable.

The input and output addresses defined in the device overview can be changed.

8.2.1 Deleting the configuration of a specified IO-Link channel

1. To delete an IO-Link channel, select the desired IO-Link channel(s) in **Device overview**:

Device overview							
Module	Rack	Slot	I address	Q address	Type	Article number	
0980-XSL-3912-121-007D	0	0: PROFINET interface			0980 XSL 3912-121-007...	935700001	
PN-IO	0	0: PROFINET interface X1			0980-XSL-3912-121-007D		
IO-Link Master_1	0	1: IO System 1.			IO-Link Master		
Status/Control Module	0	1: IO System 1. 1	1...2	1...2	Status/Control Module		
Digital In (A) / Digital (B)	0	1: IO System 1. 2: Port X1	68		Digital In (A) / Digital (B)		
Digital In (A) / Digital (B)_1	0	1: IO System 1. 3: Port X2	69		Digital In (A) / Digital (B)		
Digital In (A) / Digital (B)_2	0	1: IO System 1. 4: Port X3	70		Digital In (A) / Digital (B)		
Digital In (A) / Digital (B)_3	0	1: IO System 1. 5: Port X4	71		Digital In (A) / Digital (B)		
Digital In (A) / Digital (B)_4	0	1: IO System 1. 6: Port X5	72		Digital In (A) / Digital (B)		
Digital In (A) / Digital (B)_5	0	1: IO System 1. 7: Port X6	73		Digital In (A) / Digital (B)		
Digital In (A) / Digital (B)_6	0	1: IO System 1. 8: Port X7	74		Digital In (A) / Digital (B)		
Digital In (A) / Digital (B)_7	0	1: IO System 1. 9: Port X8	75		Digital In (A) / Digital (B)		

Figure 18: Device overview

2. Right click and then select the **Delete** option in the menu that appears:

Device overview							
Module	Rack	Slot	I address	Q address	Type	Article number	
0980-XSL-3912-121-007D	0	0: PROFINET interface			0980 XSL 3912-121-007...	935700001	
PN-IO	0	0: PROFINET interface X1			0980-XSL-3912-121-007D		
IO-Link Master_1	0	1: IO System 1.			IO-Link Master		
Status/Control Module	0	1: IO System 1. 1	1...2	1...2	Status/Control Module		
Digital In (A) / Digital (B)	0	1: IO System 1. 2: Port X1	68		Digital In (A) / Digital (B)		
		1 3: Port X2					
		1 4: Port X3					
		1 5: Port X4					
		1 6: Port X5					
Digital In (A) / Digital (B)_5	0	1: IO System 1. 7: Port X6	73		Digital In (A) / Digital (B)		
Digital In (A) / Digital (B)_6	0	1: IO System 1. 8: Port X7	74		Digital In (A) / Digital (B)		
Digital In (A) / Digital (B)_7	0	1: IO System 1. 9: Port X8	75		Digital In (A) / Digital (B)		

Figure 19: Free IO-Link channel(s)

8.2.2 Creating an IO-Link channel configuration

The *Submodules* folder of the I/O device inside the *Hardware catalog* shows all configurable options that can be selected:

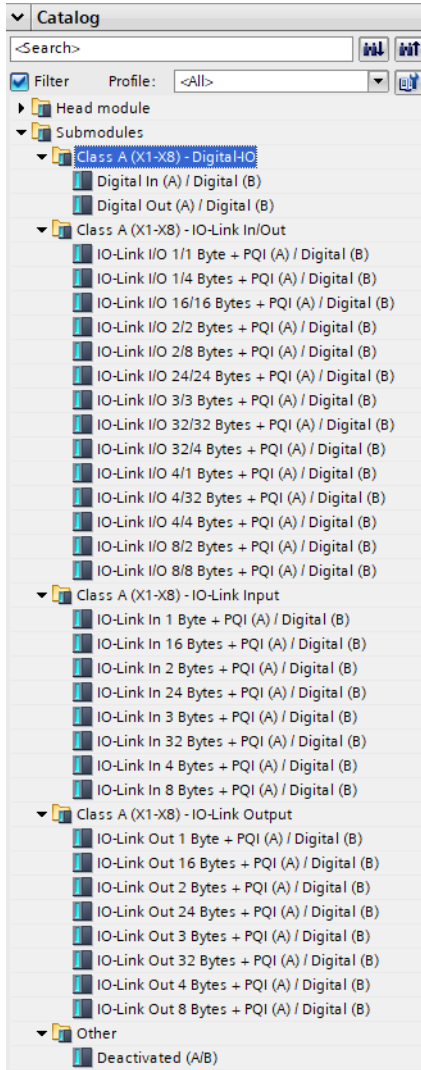

Figure 20: IO-Link channel configuration

Select the desired option, click and hold down the left mouse button to drag the configuration to a free IO-Link sub-slot:

Device overview							
Module	...	Rack	Slot	I address	Q address	Type	Article number
0980-XSL-3912-121-007D		0	0: PROFINET Interface			0980 XSL 3912-121-007...	935700001
PN-IO		0	0: PROFINET Interface X1			0980-XSL-3912-121-007D	
IO-Link Master_1		0	1: IO System 1.			IO-Link Master	
Status/Control Module		0	1: IO System 1. 1.	1...2	1...2	Status/Control Module	
Digital In (A) / Digital (B)		0	1: IO System 1. 2: Port X1	68		Digital In (A) / Digital (B)	
Digital Out (A) / Digital (B)		0	1: IO System 1. 3: Port X2		64	Digital Out (A) / Digital (B)	
IO-Link I/O 4/4 Bytes + PQI (A) ...		0	1: IO System 1. 4: Port X3	76...80	65...68	IO-Link I/O 4/4 Bytes + P...	
Digital Out (A) / Digital (B)_1		0	1: IO System 1. 5: Port X4		69	Digital Out (A) / Digital (B)	
IO-Link I/O 8/8 Bytes + PQI (A) ...		0	1: IO System 1. 6: Port X5	81...89	70...77	IO-Link I/O 8/8 Bytes + P...	
Deactivated (A/B)		0	1: IO System 1. 7: Port X6			Deactivated (A/B)	
Digital In (A) / Digital (B)_6		0	1: IO System 1. 8: Port X7	74		Digital In (A) / Digital (B)	
Digital In (A) / Digital (B)_7		0	1: IO System 1. 9: Port X8	75		Digital In (A) / Digital (B)	

The following options are available for the IO-Link C/Q channel (Ch. A/Pin 4):

Digital In (DI)

In this mode the channel operates as a digital input.

Digital Out (DO)

In this mode, the channel operates as a digital output.

Deactivated

This mode should be selected if the A-channels and the B-channels of the I/O ports (ports X1-X8) are not used. The L+ power supply (pin 1) of the port is disabled in this case.

IO-Link ...

In this mode (IO-Link communication mode), the process data from or to the device are exchanged over a communication link. Depending on the port configuration, the IO-Link Master automatically starts communicating with the connected IO-Link Device, taking into account the baud rate. Additionally, this mode offers the option of parameterizing the IO-Link Device. Configuration modules with data lengths of 1-33 bytes for physical inputs and 1-32 bytes for physical outputs are available. If no suitable configuration module is available for the device, the next larger data length must be selected. After the first configuration of the device, this port configuration will be stored non-volatile on the IO-Link Master. This means that with the next power-up the I/O port

will be pre-configured with these settings before the controller will send a new port configuration. The sensor supply (I/O port Pin 1) and the auxiliary supply (I/O port Pin 2) will be powered up directly depending on the last active configuration. A configuration telegram of the PN-Controller is not being required. The I/O data remain invalid until a new configuration is received after the power-up of the IO-Link Master.

8.3 Parameterization of the Status/Control Module

Device overview						
Module	Rack	Slot	I address	Q address	Type	
▼ 0980-XSL-3911-121-007D	0	0: PROFINET Interface			0980 XSL 3911-121-007D-00F	
▶ PN-IO	0	0: PROFINET Interface X1			0980-XSL-3911-121-007D	
▼ IO-Link Master_1	0	1: IO System 1.			IO-Link Master	
Status/Control Module	0	1: IO System 1. 1	1...2	1...2	Status/Control Module	
Digital In (A) / Digital (B)	0	1: IO System 1. 2: Port X1	68		Digital In (A) / Digital (B)	
Digital Out (A) / Digital (B)	0	1: IO System 1. 3: Port X2		64	Digital Out (A) / Digital (B)	
Digital In (A) / Digital (B)_1	0	1: IO System 1. 4: Port X3	69		Digital In (A) / Digital (B)	
IO-Link I/O 4/4 Bytes + PQI (A) / Digital (B)	0	1: IO System 1. 5: Port X4	70...74	65...68	IO-Link I/O 4/4 Bytes + PQI (A) ...	
Digital In (A) / Digital (B)_2	0	1: IO System 1. 6: Port X5	75		Digital In (A) / Digital (B)	
IO-Link I/O 4/4 Bytes + PQI (A) / Digital (B)...	0	1: IO System 1. 7: Port X6	76...80	69...72	IO-Link I/O 4/4 Bytes + PQI (A) ...	
Deactivated (A/B)_6	0	1: IO System 1. 8: Port X7			Deactivated (A/B)	
Deactivated (A/B)_7	0	1: IO System 1. 9: Port X8			Deactivated (A/B)	

Figure 21: Status/Control Module

Parameters within the Status/Control Module:

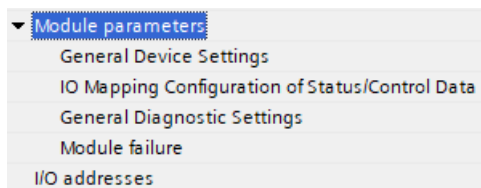

Figure 22: Parameters Status/Control Module

The Status/Control Module in slot 1/sub-slot 1 is pre-configured for each LioN-X IOL-Master. It consists of 2 bytes of input and 2 bytes of output data for the digital I/O data. The bit assignments are described in Section [Process data assignment](#) on page 128.

The Status/Control Module can also be used to perform some general parameterizations that do not affect any functionality of channels in IO-Link mode.

The following parameterizations are possible after clicking on the subitems under the *Module parameters*.

8.3.1 General Device Settings

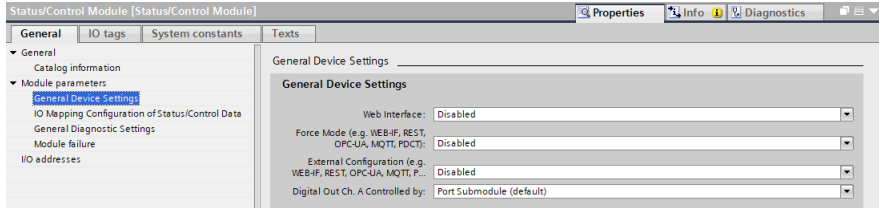

Web Interface

The Web interface access can be set to "Enabled" or "Disabled" with this parameter. In case of the "Disabled" setting, the Web pages are not reachable.

Default: Enabled

Force Mode

The input and output I/O data can be forced (= changed) for implementation reasons. This can be done by different interfaces (e.g. Web-Interface, REST, OPC UA, MQTT). The support of interfaces for Forcing depends on the chosen software variant. With this function the possibility of forcing I/O data can be enabled or disabled.

Default: Disabled



Danger: Risk of physical injury or death! Unattended forcing can lead to unexpected signals and uncontrolled machine movements.

External Configuration

Configuration and parameter data can be set over different external interfaces outside the GSDML configuration (e.g. Web-Interface, REST, OPC UA, MQTT). With this option, the "External Configuration" can be enabled or disabled. An external configuration is only valid until a new configuration is received by the PROFINET controller.

Default: Disabled

Digital Out Ch. A controlled by...

► Port Sub-module:

For controlling the digital A-channels, the output **Byte 1/Bit 0** of the appropriate sub-slot module must be used.

► Status/Control Module:

In this case, the digital A-channel outputs can be controlled by the Status/Control Module output bits. The digital output can be controlled only by one data source.

Default: Port Sub-module

8.3.2 I/O mapping configuration of Status/Control data

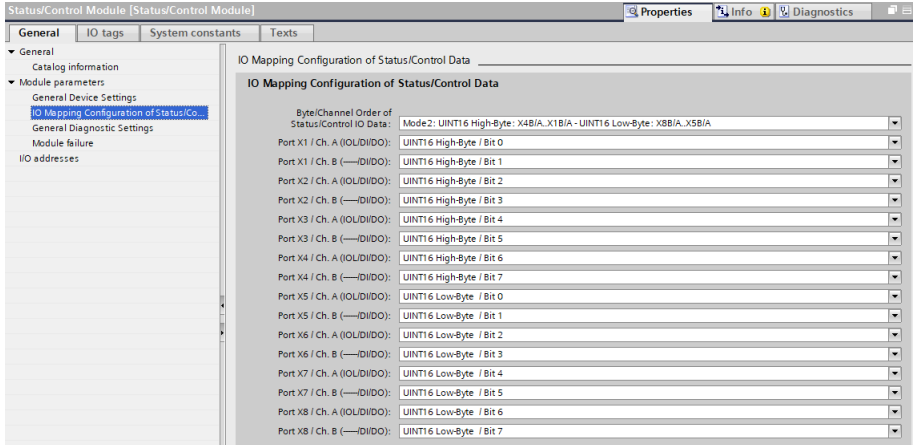

Byte/Channel order of Status/Control I/O data

With this parameter, 4 (Mode 1 – 4) pre-defined bit mappings for the digital I/O bits can be selected. The I/O data will be mapped to the Status/Control Module's input and output bytes.

Mode 5 can be used for a free, user defined mapping. The parameter settings “Port X1 / Channel A” – “Port X8 / Channel B” must be used for this. These parameters enable all I/O channels to be freely assigned to a Bit in the Status/Control I/O data. It should be noticed that duplicate assignments are not possible here. If faulty parameterization is detected in the LiON-X module, a fault will be registered.

When chosen Mode 1 – Mode 4, the “Port X1 / Channel A” – “Port X8 Channel B” settings will be ignored in the LiON-X module.

The chosen mapping will be used in the same way for input and output data direction.

Key

UINT16 High-Byte = 1st / low address byte in a Siemens PLC

UINT16 Low-Byte = 2nd / high address byte in a Siemens PLC
(applicable for a Siemens PLC using Big-Endian format)

Mode 1:

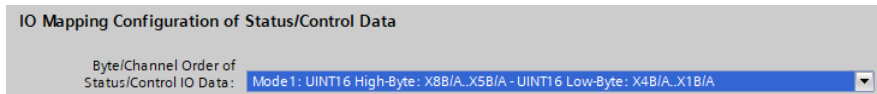

Mode 2:

Default from GSDML-V2.35-BeldenDeutschland-LioN-X-20211122 and higher; prior versions have "Mode 1" as default.



Mode 3:



Mode 4:

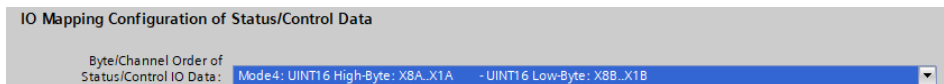

Mode 5:

IO Mapping Configuration of Status/Control Data

Byte/Channel Order of Status/Control IO Data: **Mode5: Free Mapping by using below 16 parameters**

Port X1 / Ch. A (IOL/DI/DO):	UINT16 High-Byte / Bit 0
Port X1 / Ch. B (—/DI/DO):	UINT16 High-Byte / Bit 1
Port X2 / Ch. A (IOL/DI/DO):	UINT16 High-Byte / Bit 2
Port X2 / Ch. B (—/DI/DO):	UINT16 High-Byte / Bit 3
Port X3 / Ch. A (IOL/DI/DO):	UINT16 High-Byte / Bit 4
Port X3 / Ch. B (—/DI/DO):	UINT16 High-Byte / Bit 5
Port X4 / Ch. A (IOL/DI/DO):	UINT16 High-Byte / Bit 6
Port X4 / Ch. B (—/DI/DO):	UINT16 High-Byte / Bit 7
Port X5 / Ch. A (IOL/DI/DO):	UINT16 Low-Byte / Bit 0
Port X5 / Ch. B (—/DI/DO):	UINT16 Low-Byte / Bit 1
Port X6 / Ch. A (IOL/DI/DO):	UINT16 Low-Byte / Bit 2
Port X6 / Ch. B (—/DI/DO):	UINT16 Low-Byte / Bit 3
Port X7 / Ch. A (IOL/DI/DO):	UINT16 Low-Byte / Bit 4
Port X7 / Ch. B (—/DI/DO):	UINT16 Low-Byte / Bit 5
Port X8 / Ch. A (IOL/DI/DO):	UINT16 Low-Byte / Bit 6
Port X8 / Ch. B (—/DI/DO):	UINT16 Low-Byte / Bit 7

For detailed I/O mapping refer to chapter [Process data Status/Control Module, I/O system 1.1](#) on page 128.

8.3.3 General Diagnostic Settings

Voltage information U_L

- ▶ The label U_L (Load voltage) is used for devices which exclusively have Class A IO-Link ports.

8.3.3.1 Diagnostic settings for modules with IO-Link Class A ports

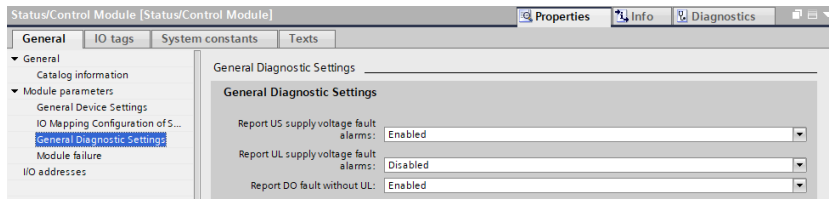

Report U_S supply voltage fault alarms

The U_S supply voltage fault alarm can be set to "Disabled" or "Enabled" with this parameter.

Default: Enabled

Report U_L supply voltage fault alarms

The U_L supply voltage fault alarm can be set to "Disabled", "Enabled" or "Auto Mode" with this parameter.

In "Auto Mode", the U_L diagnosis will be activated with the first rising slope detection after power-up.

Default: Disabled



Attention: "Report U_L supply voltage fault" is disabled in the default setting to avoid diagnostic messages due to switching the supply voltage on or off later on.

Report DO fault without U_L

The diagnosis of digital outputs can be configured in dependency of the U_L status.

When the output will be active without active U_L while this parameter is set to "Enabled", a diagnosis message will be generated for the output channel.

Default: Enabled

8.4 Parameterization of the I/O ports X1 .. X8

In the device configuration mode, click on the corresponding IO-Link sub-slot in the Device overview and select the option *module parameters* for setting the following parameters:

Device overview						
Module	...	Rack	Slot	I address	Q address	Type
▼ 0980-XSL-3911-121-007D		0	0: PROFINET Interface			0980 XSL 3911-121-007D-00F
▶ PN-IO		0	0: PROFINET Interface X1			0980-XSL-3911-121-007D
▼ IO-Link Master_1		0	1: IO System 1.			IO-Link Master
Status/Control Module		0	1: IO System 1. 1	1...2	1...2	Status/Control Module
Digital In (A) / Digital (B)		0	1: IO System 1. 2: Port X1	68		Digital In (A) / Digital (B)
Digital Out (A) / Digital (B)		0	1: IO System 1. 3: Port X2		64	Digital Out (A) / Digital (B)
Digital In (A) / Digital (B)_1		0	1: IO System 1. 4: Port X3	69		Digital In (A) / Digital (B)
IO-Link I/O 4/4 Bytes + PQI (A) / Digital (B)		0	1: IO System 1. 5: Port X4	70...74	65...68	IO-Link I/O 4/4 Bytes + PQI (A) ...
Digital In (A) / Digital (B)_2		0	1: IO System 1. 6: Port X5	75		Digital In (A) / Digital (B)
IO-Link I/O 4/4 Bytes + PQI (A) / Digital (B)...		0	1: IO System 1. 7: Port X6	76...80	69...72	IO-Link I/O 4/4 Bytes + PQI (A) ...
Deactivated (A/B)_6		0	1: IO System 1. 8: Port X7			Deactivated (A/B)
Deactivated (A/B)_7		0	1: IO System 1. 9: Port X8			Deactivated (A/B)

General | IO tags | System constants | Texts

General

- Catalog information
- Hardware interrupts
- Module parameters**
- I/O addresses

Module parameters

Enhanced Port Parameters

- Sensor Supply Mode Pin 1(L+): Active
- DI Filter, Ch. B: 3ms
- DI Logic, Ch. B: Normally Open (NO)
- DO Restart Mode, Ch. B: Restart after Output Reset
- DO Switch Mode, Ch. B: High-Side Switch (Pwr supply by UL): 2,0A Max.
- DO Failsafe Value, Ch. B: Set Low
- DO Surveillance Timeout (in millisecond), Ch. B: 80
- IOL In-Data Swapping Mode, Ch. A: Off
- IOL In-Data Swapping Type, Ch. A: Word
- IOL In-Data Swapping Offset, (Bytes) Ch. A: 0
- IOL Out-Data Swapping Mode, Ch. A: Off
- IOL Out-Data Swapping Type, Ch. A: Word
- IOL Out-Data Swapping Offset, (Bytes) Ch. A: 0

Failsafe Port Parameters for Ch. A in IO-Link Mode

- Failsafe Value(s): Set Low
- Replacement Value (Byte 1, enter in decimal): 0
- Replacement Value: 0
- Replacement Value: 0
- Replacement Value (Byte n, enter in decimal): 0

Standardized Port Parameters

- Digital Mode, Ch. B (I/Q): Digital Input
- Port Diagnostics, L+ / Ch. A (C/Q) / Ch. B (Q) / Device errors and ...: Enabled
- Process Alarms (notifications), Ch. A (COM): Enabled
- Configuration Source: PROFINETIO Controller
- Input Fraction, Ch. A (COM): Disabled
- Pull/Plug Alarms, Ch. A (COM): Enabled
- Port Mode Ch. A (COM): IO-Link - autostart (below options excluded)
- Validation and Backup, Ch. A (COM): No device check
- Port Cycle Time, Ch. A (COM): As fast as possible
- Vendor ID, Ch. A (COM): 0
- Device ID, Ch. A (COM): 0

Figure 23: Parameter of the IO-Link channels

8.4.1 Enhanced port parameters

In dependency of the configured sub-module, some of the following described parameters can differ.

(Available only for special channel, otherwise not available.)

Sensor Supply Mode Pin 1 / L+

The sensor supply on pin 1 is always active and cannot be disabled.

DI Filter

With this parameter, the filter time of the digital input can be defined. The following options are available:

Off; 1 ms; 2 ms; 3 ms; 6 ms; 10 ms; 15 ms

Default: 3 ms

DI Logic

This parameter can be used to configure the logic of the channels used as digital inputs.

► NO (Normally Open):

A non-damped sensor has an open switching output (low signal) in this case. The device input detects a low signal and returns a "0" to the control unit.

The LED of the channel shows the physical input state.

► NC (Normally Closed):

A non-damped sensor has a closed switching output (high signal) in this case. The device input detects a high signal, inverts the signal, and returns a "0" to the control unit.

The channel LED displays, independent of the setting, the physical input state.

Default: NO (Normally Open) for all channels

DO Restart Mode

With this parameter, the digital output restart behavior can be set.

► Automatic Restart after Failure:

In case of detecting an output short circuit or overload, the output will be switched off by the IO-Link Master. However, after a time delay, the output will automatically be turned on again for checking if the overload or short circuit condition is active.

► Restart after Output Reset:

In case of detecting an output short circuit or overload, the output will be switched off by the IO-Link Master.

The output will not be set automatically. Before the output can be turned on again, it must be logically reset by the PLC.

Default: Automatic Restart after Failure

DO Switch Mode (0980 XSL... variants only)

With this option, the mode of the digital output switch can be selected.

► Push Pull Switch (0.5 A):

In this mode, the output will be switched active to high and low. In low state, the output can be a current sink. In this mode, the digital output will be supplied by U_S .

► High-Side Switch (0.5 A; 1.0 A; 1.5 A; 2.0 A; 2.0 A Max.):

In this mode, the output will be switched active to high, but not to low. Output low means high impedance at digital output. Additionally, the current limitation can be selected for each digital output in High-Side Switch mode. This means that the level for actuator overload diagnostic can be managed by this selection. *2.0 A Max.* means, that current limitation is **not** active and the maximum output current for this output is available. In these modes, the digital output will be supplied by U_L .

Refer to chapter [I/O port overview](#) on page 21 for the voltage supply of the digital outputs.

Default: High-Side Switch (2.0 A Max.)

DO Failsafe Value

The device supports a failsafe function for the channels used as digital outputs. During configuration of the devices, the status of the PROFINET IO device outputs can be defined after an interruption, or loss of communication on the PROFINET IO network.

The following options can be selected:

- ▶ Set Low - the output channel is disabled and/or the output bit set to "0".
- ▶ Set High - the output channel is enabled and/or the output bit set to "1".
- ▶ Hold last – the last output state is kept.

Default: Set Low

DO Surveillance Timeout

For channels configured as digital output, the firmware of the modules allows you, for this special use case, to set a delay time before output status monitoring is enabled.

The delay time is referred to as the "Surveillance-Timeout" and can be configured for each output channel. The delay time begins with a rising edge of the output control bit. After this time has elapsed, the output is monitored, and error states are reported by diagnostics.

The *Surveillance-Timeout* parameter can be set from 0 to 255 ms. When an output channel is in static state, i.e., when the channel is permanently switched on or off, the typical filter value (not changeable) before a diagnostic message is 5 ms.

Default: 80 ms

IO-Link Input/Output Data Swapping

With the following parameters, the IO-Link byte data order can be setup separately for Input and Output data direction.

► **Swapping Mode:**

The byte order swapping will be made for the selected count of data types or for the complete length of I/O data with the selected Data Type (Word = 2 Bytes or DWord = 4 Bytes).

Default: Off

► **Swapping Data Type:**

The swapping can be setup to Word (2 Bytes) or DWord (4 Bytes):

- Word Swapping: Byte 1 - Byte 2 => Byte 2 - Byte 1
- DWord Swapping: Byte 1 - Byte 4 => Byte 4 - Byte 1

The Data Type value has no effect when the Swapping Mode is setup to "Off".

Default: Word

► **Swapping Offset:**

A swapping offset in bytes can be setup in dependency of the configured I/O data length.

When setup to "2", the swapping will be processed from the 3rd Byte.

Default: 0

8.4.2 Failsafe port parameters for Ch. A in IO-Link mode

The following values are selectable (for output data only):

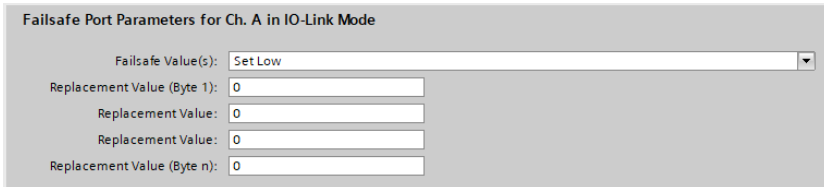

Failsafe Port Parameters for Ch. A in IO-Link Mode

Failsafe Value(s): Set Low

Replacement Value (Byte 1): 0

Replacement Value: 0

Replacement Value: 0

Replacement Value (Byte n): 0

Figure 24: Failsafe Configuration

For a proper function of the IO-Link failsafe values, the IO-Link Device parameters should be set in the same way, if possible. In the case of a lost network connection, the IO-Link Master sends, according to its failsafe configuration, output data to the IO-Link Device. If the IO-Link Device connection is lost, the IO-Link Device uses the failsafe options parameterized inside the device, if supported.

When the device supports a failsafe mechanism, choose the option *IO-Link Master Command*.

Set Low

All bits of the output data with a value of "0" are transmitted to the IO-Link Device. (Default setting)

Set High

All bits of the output data with a value of "1" are transmitted to the IO-Link Device.

Hold Last

The last valid output value received by the control unit is continuously and cyclically transmitted to the IO-Link Device.

For proper *Hold Last* behavior the appropriate IOL-Device parameters must also be set to *Hold Last*.

Replacement Value

If this option is selected, the value entered in the **Replacement Value** input field described [below](#) is continuously and cyclically transmitted to the IO-Link Device.

IO-Link Master Command

The *IO-Link Master Command* option allows the use of IO-Link-specific mechanisms for valid/invalid output process data. Thus, the device itself determines the behavior.

Replacement Value

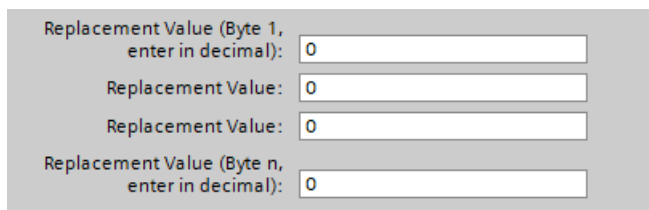

The screenshot shows a configuration window with a grey background. It contains four input fields, each with a label and a text box containing the number '0'. The labels are: 'Replacement Value (Byte 1, enter in decimal):', 'Replacement Value:', 'Replacement Value:', and 'Replacement Value (Byte n, enter in decimal):'.

Figure 25: Byte data

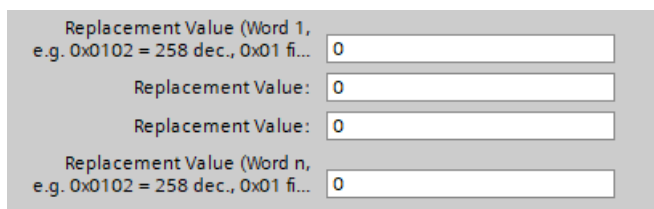

The screenshot shows a configuration window with a grey background. It contains four input fields, each with a label and a text box containing the number '0'. The labels are: 'Replacement Value (Word 1, e.g. 0x0102 = 258 dec., 0x01 fi...', 'Replacement Value:', 'Replacement Value:', and 'Replacement Value (Word n, e.g. 0x0102 = 258 dec., 0x01 fi...'.

Figure 26: Word data

If the "Fail Safe Value(s)" option is set to "Replacement Value", the substitute value(s) entered in this/these input field(s) is/are used.

The value must be entered as a decimal value. Depending on the configured data length, the values must be entered as bytes (0-255) or word decimal values (0-65535) in the order shown.

- ▶ Byte 1 = high order byte (UINT8), in decimal
- ▶ Byte n = low order byte (UINT8), in decimal

- ▶ Word 1 = high order word (UINT16), in decimal
- ▶ Word n = low order word (UINT16), in decimal

"Word" examples: 0x0102 = 258 dec., 0x01 = first byte for IO-Link device,
0x02 = second byte for IO-Link device.

8.4.3 Standardized port parameters

Digital Mode, Ch. B

With this parameter the mode of channel B can be defined. The following modes are available:

- ▶ Disabled
- ▶ Digital Input
- ▶ Digital Output
- ▶ Power Supply Output (fed from U_L voltage)

Port Diagnostic, Ch. A

The IO-Link Master port diagnostics and the IO-Link Device alarms of type "error" or "warning" can be enabled or disabled over this option.

Default: Enabled

Process Alarm, Ch. A (Device Notifications)

The IO-Link Device alarm notifications can be enabled or disabled with this option. Disabled means, that all notification alarm types from every IO-Link Device will be suppressed by the IO-Link Master. They will be not forwarded by PROFINET alarms to the controller.

Default: Enabled

Configuration Source, Ch. A

- ▶ PROFINET IO Controller:

The IO-Link Master port configuration will be assigned by the PROFINET IO Controller.

- ▶ Port and Device Configuration Tool (not supported yet):

The IO-Link Master port configuration will be assigned by an external IO-Link Port and Device Configuration Tool.

Default: PROFINET IO Controller

Input Fraction, Ch. A

If the user configures a sub-slot module with less than the real input data of the device, the IO-Link Master sends as much as possible IO-Link Device input bytes to the PLC inclusive the PQI byte of the sub-slot module. As a consequence, only "0" up to (Device Input Length - 1) octets of the input data of the device can be mapped to the PROFINET process input data of the IO-Link Master. If this option is disabled, a data length mismatch alarm is active in the case of a mismatching input data length. In case of an output data mismatch, a process data mismatch diagnosis will be generated independently of the selected "Input Fraction" setting.

Default: Disabled

Pull/Plug, Ch. A

Enables or Disables Pull/Plug alarms of an IOL-Device (Add/Remove Submodule). A failure or the return of an IO-Link Device can be mapped via PROFINET Plug or Pull alarms. This mapping is independent from any phase such as power-up or start-up.

► Plug Alarms:

- Ready to Operate (IOL-Device is ready)
- COM Fault (incorrect device or other problems) – IOL-Device started but not ready due to fault.

► Pull Alarms:

- COM Fault (No IOL-Device)

In the "Disabled" option, channel diagnostics will be generated in case of losing an IO-Link Device.

Default: Enabled

Port Mode, Ch. A

► Deactivated:

With the "Deactivated" option, an IO-Link port can be configured for later use. No diagnostics are generated if the IO-Link Device is not connected.

► IO-Link - Autostart:

With the "Plug&Play" option no explicit port configuration is needed. Basic assignments such as *Validation and Backup* (Inspection Level), *Port Cycle Time*, *Vendor ID* and *Device ID* are not required.

► IO-Link - Manual:

Explicit port configuration possible for *Validation and Backup* (Inspection Level), *Port Cycle Time*, *Vendor ID* and *Device ID*. These Parameters are GSD based and can be set over a PROFINET engineering system.

Default: IO-Link Autostart

Overview and dependencies of the *Port Mode* configuration type:

Feature	IO-Link - autostart	IO-Link - manual (GSD)
Access on Process Data (PD)	Yes	Yes
Diagnostics of port & device	Yes	Yes
I&M data (IM0) access	Yes	Yes
Device check (consolidated/real)	No	Yes
Backup & Restore	No	Yes
Device parameterization (PDCT)	No	No
Commissioning (online)	No	No

Table 11: Overview, port mode config types

Validation and Backup, Ch. A

For using the *Validation and Backup* functionality of the IOL-Master, the port mode must be set to *IO-Link - manual*.

In dependency of the *Validation and Backup* setting, the entry of the parameters *Vendor ID* and *Device ID* might be obligatory.

▶ No IOL-Device check (default):

No check of connected *Vendor ID* or *Device ID* and no *Backup and Restore* support of the IOL-Master backup memory.

▶ Type compatible (V1.0) IOL-Device:

Type compatible according to IO-Link specification V1.0 including validation of *Vendor ID* and *Device ID*. IO-Link specification V1.0 does not support IO-Link Master parameter backup memory and restore function.

▶ Type compatible (V1.1) IOL-Device:

Type compatible according to IO-Link specification V1.1, check of *Vendor ID* and *Device ID* by IOL-Master.

▶ Type compatible (V1.1) IOL-Device with Backup & Restore:

Type compatible according to IO-Link specification V1.1, check of *Vendor ID* and *Device ID* by IOL-Master with *Backup* (IOL-Device to IOL-Master) and *Restore* (IOL-Master to IOL-Device) of the IOL-Device parameters.

Pay attention to the following explanations regarding *Backup and Restore* conditions:

Backup (Upload / IOL-Device to IOL-Master):

During the first connection to an IO-Link Device after enabling this mode, the IOL-Master uploads the IOL-Device parameter into the backup memory. (In this case the backup memory had been empty. Watch below for further information about resetting the IO-Link Master parameter backup memory.)

An upload will also be performed, when the IO-Link Device has set the DS_UPLOAD_FLAG (Data Storage Upload Flag). This IOL-Device flag can be set in two ways:

- Parameters written to IOL-Device in *Block Parameter* mode: An IO-Link Device sets the DS_UPLOAD_FLAG self-dependent, if the parameters were written in block parameter mode to the IO-Link Device with the last system command ParamDownloadStore (e.g. by a third party USB IO-Link Master for commissioning).
- Parameters written to IOL-Device in *Single Parameter* mode: If parameters are written to the device in single parameter mode (e.g. one Sub-Index of a parameter Index), the device parameter backup memory on the IOL-Master can be updated by using the ParamDownloadStore system command (Index 0x0002, Sub-Index 0x00, Value 0x05). This command sets the DS_UPLOAD_FLAG (backup request) on the IOL-Device in direction of the IOL-Master, and thus the IOL-Master performs a transfer from IOL-Device to IOL-Master backup memory.

Restore (Download / IOL-Master to IOL-Device):

For each new connection to an IO-Link Device, the IOL-Master compares the stored parameters with the IOL-Device parameters and downloads the stored backup parameters to the IOL-Device in case of differences.

The restore procedure can be blocked by the IO-Link Device via the *Device Access Locks* parameter when supported by the IO-Link Device (Index 0x000C, refer to vendor specific IO-Link Device documentation).

► Type compatible (V1.1) IOL-Device with Restore:

Type compatible according to IO-Link specification V1.1, check of *Vendor ID* and *Device ID* by IOL-Master with *Restore* (IOL-Master to IOL-Device) of the IOL-Device parameters.

Pay attention to the following explanations regarding *Restore* conditions:

Restore (Download / IOL-Master to IOL-Device):

During the first connection to an IO-Link Device after enabling this mode, the IOL-Master uploads the IOL-Device parameters once into the backup memory.

With each further connection to an IO-Link Device, the IOL-Master compares the stored parameters with the IOL-Device parameters and downloads the stored backup parameters to the IOL-Device in case of differences.

In the *Restore* mode no change of the IOL-Device parameters will be stored in the IOL-Master backup memory. When the IOL-Device sets the *DS_UPLOAD_FLAG* in this mode, the IOL-Device parameters will be restored from the IOL-Master.

The restore procedure can be blocked by the IO-Link Device via the *Device Access Locks* parameter when supported by the IO-Link Device (Index 0x000C, refer to vendor specific IO-Link Device documentation).

► Reset conditions of IO-Link Master parameter backup memory:

The IO-Link Master backup memory will be deleted by the following events:

- IO-Link Master factory reset
- A port configuration change, e.g. from “Digital-Input” to “IO-Link Mode”
- A change in the *Validation and Backup* settings, e.g. from “No IOL-Device Check” to “Type compatible IOL-Device (V1.1) with Backup & Restore”

For further information refer to the ‘IO-Link Interface and System Specification’ version 1.1.3 which can be downloaded from <https://io-link.com/>.

Default: No IOL-Device check



Attention: An IO-Link Device sets the “upload flag” self-dependent, if parameter were written in block mode to the IO-Link Device.

Port Cycle Time, Ch. A

(Port mode *IO-Link - manual* required)

► As fast as possible:

The IO-Link Master uses the max. supported IOL-Device update cycle time limited by the max. supported IOL-Master cycle time for the cyclic I/O data update between IOL-Master and IOL-Device.

► 1.6, 3.2, 4.8, 8, 20.8, 40, 80, 120 ms:

The cycle time can be set manually to the provided options. This option can be used e.g. for IOL-Device modules which are connected over inductive couplers. Inductive couplers are normally the bottleneck in the update cycle time between IOL-Master and IOL-Device. In this case, please refer to the data sheet of the inductive coupler.

Default: As fast as possible

Vendor ID, Ch. A

(Port mode *IO-Link - manual* required)

The Vendor ID of the connected IOL-Device used can be entered as a decimal value [0 ... 65535] and will be in used in dependency of the *Validation and Backup* settings for the validation of the type compatibility.

Default: 0

Device ID, Ch. A

(Port mode *IO-Link - manual* required)

The *Device ID* of the connected IOL-Device can be entered as a decimal value [0 ... 65535] and will be in used in dependency of the *Validation and Backup* settings for the validation of the type compatibility.

Default: 0

8.5 IO-Link Device Parameterization

8.5.1 SIEMENS IO-Link library

The SIEMENS "IO_LINK_DEVICE" function block (FB50001) can perform acyclic writing or reading data of an IOL-Device connected to the IO-Link Master.

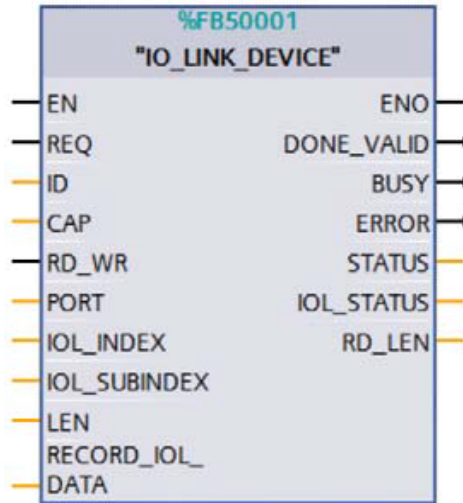

Figure 27: "IO_LINK_DEVICE" FB in STEP 7 V15.1

IOL-Device data are uniquely addressed via the index and the sub-index and can be accessed or written via the hardware identifier of the status/control module (ID) inputs, the client access point (CAP = 0xB400) and the corresponding IO-Link port (PORT: 1 - 8 for IO-Link ports).

The following TIA project shows the used hardware identifier of the sub-module for port X1 (282) with Write/Read examples. Alternatively, the hardware identifier of the Status/Control module can also be used (281 in this example).

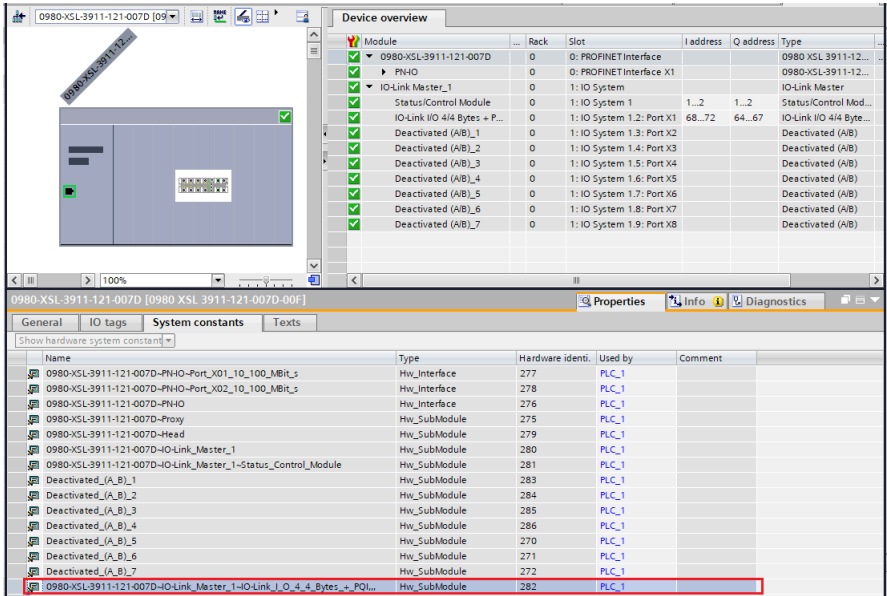

Figure 28: TIA project: Write/Read example with FB50001

8.5.1.1 SIEMENS function block FB50001 – write example

The following is a write example for an IOL-Device on port X1 at the application tag parameter (IOL_INDEX=24). The input data are in decimal. The write data are in hexadecimal. The written value is "test" (= 74 / 65 / 73 / 74 in HEX).

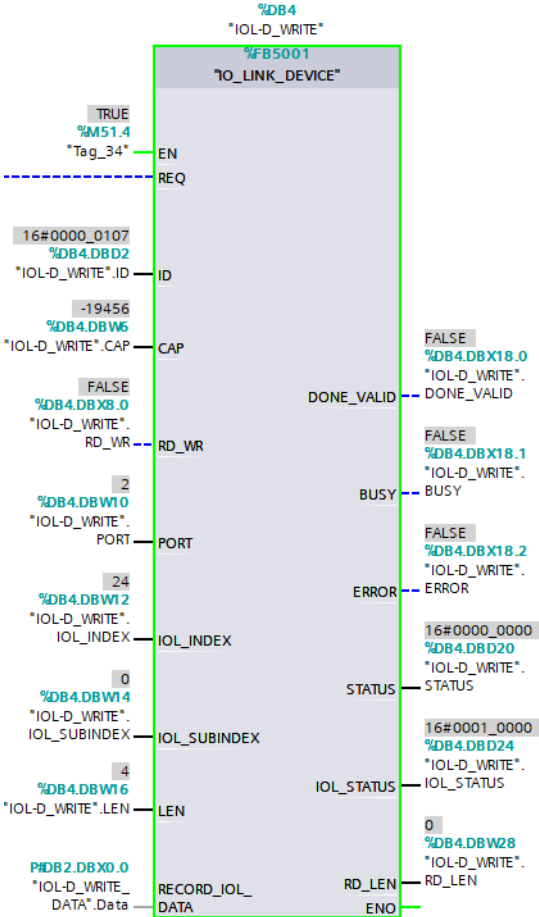

Figure 29: write example for FB50001

Name	Data type	Offset	Start value	Monitor value	Retain	Visible in ...	Setpoint	Comment
1	Input							
2	REQ	0.0	false	FALSE	<input checked="" type="checkbox"/>	<input checked="" type="checkbox"/>	<input type="checkbox"/>	request function
3	ID	2.0	263	16#0000_0107	<input checked="" type="checkbox"/>	<input checked="" type="checkbox"/>	<input type="checkbox"/>	hardware identifier of IO-Link master module (0
4	CAP	6.0	INT#46080	-19456	<input checked="" type="checkbox"/>	<input checked="" type="checkbox"/>	<input type="checkbox"/>	Client Access Point (CAP), for ET200 always 227
5	RD_WR	8.0	false	FALSE	<input checked="" type="checkbox"/>	<input checked="" type="checkbox"/>	<input type="checkbox"/>	read and write access on IO-Link device 0: rea
6	PORT	10.0	2	2	<input checked="" type="checkbox"/>	<input checked="" type="checkbox"/>	<input type="checkbox"/>	number of port on IO-Link master module (ET2
7	IOL_INDEX	12.0	INT#24	24	<input checked="" type="checkbox"/>	<input checked="" type="checkbox"/>	<input type="checkbox"/>	address parameter Index (IO-Link Device) 0..3;
8	IOL_SUBINDEX	14.0	INT#0	0	<input checked="" type="checkbox"/>	<input checked="" type="checkbox"/>	<input type="checkbox"/>	address parameter Subindex (IO-Link Device) 1
9	LEN	16.0	INT#4	4	<input checked="" type="checkbox"/>	<input checked="" type="checkbox"/>	<input type="checkbox"/>	length of writing data (netto data)

Figure 30: Input control data for write request via FB50001

Name	Data type	Offset	Start value	Retain	Visible in ...	Setpoint	Comment
1	Static						
2	Data	Array[0..231] of Byte	0.0		<input checked="" type="checkbox"/>	<input type="checkbox"/>	
3	Data[0]	Byte	0.0	16#74	<input checked="" type="checkbox"/>	<input type="checkbox"/>	'r'
4	Data[1]	Byte	1.0	16#65	<input checked="" type="checkbox"/>	<input type="checkbox"/>	'r'
5	Data[2]	Byte	2.0	16#79	<input checked="" type="checkbox"/>	<input type="checkbox"/>	'r'
6	Data[3]	Byte	3.0	16#74	<input checked="" type="checkbox"/>	<input type="checkbox"/>	'r'
7	Data[4]	Byte	4.0	16#0	<input checked="" type="checkbox"/>	<input type="checkbox"/>	

Figure 31: Data to be written via FB50001

1	Output							
2	DONE_VALID	Bool	18.0	false	FALSE	<input checked="" type="checkbox"/>	<input checked="" type="checkbox"/>	validity 0: data invalid ; 1: data valid
3	BUSY	Bool	18.1	false	FALSE	<input checked="" type="checkbox"/>	<input type="checkbox"/>	0: request finish 1: request in progress
4	ERROR	Bool	18.2	false	FALSE	<input checked="" type="checkbox"/>	<input type="checkbox"/>	Error flag = 0: no error; 1: function aborted with
5	STATUS	DWord	20.0	DW# 16#00000000	16#0000_0000	<input checked="" type="checkbox"/>	<input type="checkbox"/>	DPI PHIO - error status ; ERROR flag = 1 - commi
6	IOL_STATUS	DWord	24.0	DW# 16#00000000	16#0001_0000	<input checked="" type="checkbox"/>	<input type="checkbox"/>	IO-Link error status; ERROR flag = 1: IO-Link erro
7	RD_LEN	int	28.0	INT#0	0	<input checked="" type="checkbox"/>	<input type="checkbox"/>	length of read data record (number of bytes)

Figure 32: Output status for write request via FB50001

8.5.1.2 SIEMENS function block FB50001 – read example

The following is a read example for an IOL-Device on port X1 at the application tag parameter (**IOL_INDEX=24**). The input data are in decimal. The read data are in hexadecimal. The previously written value "test" (= 74 / 65 / 73 / 74 in HEX) will be read here.

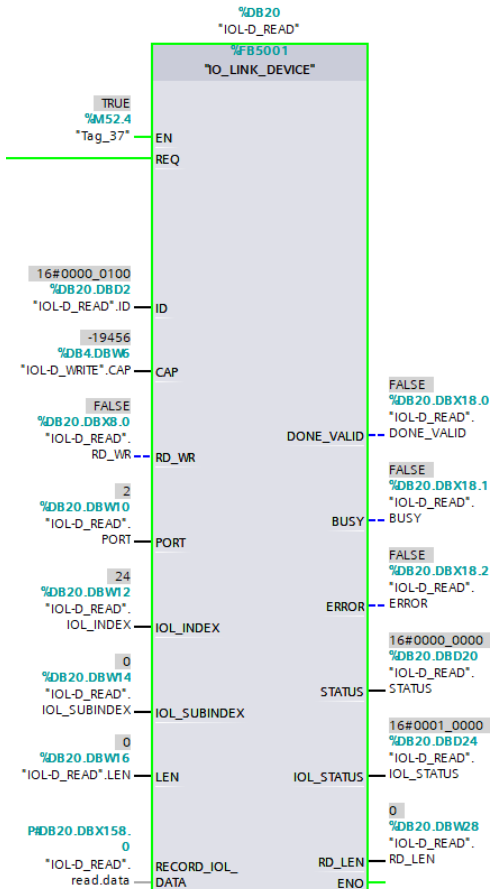

Figure 33: Read example for FB50001

IOL-D_READ									
Name	Data type	Offset	Start value	Monitor value	Retain	Visible in ...	Setpoint	Comment	
1	Input								
2	REQ	Bool	0.0	false	FALSE	<input checked="" type="checkbox"/>	<input checked="" type="checkbox"/>	request function	
3	ID	DWord	2.0	256	16#0000_0100	<input checked="" type="checkbox"/>	<input checked="" type="checkbox"/>	hardware identifier of IO-Link master module (0	
4	CAP	Int	6.0	INT#46080	-19456	<input checked="" type="checkbox"/>	<input checked="" type="checkbox"/>	Client Access Point (CAP), for ET200 always 227	
5	RD_WR	Bool	8.0	false	FALSE	<input checked="" type="checkbox"/>	<input checked="" type="checkbox"/>	read and write access on IO-Link device 0: rea	
6	PORT	Int	10.0	INT#2	2	<input checked="" type="checkbox"/>	<input checked="" type="checkbox"/>	number of port on IO-Link master module (ET2)	
7	IOL_INDEX	Int	12.0	24	24	<input checked="" type="checkbox"/>	<input checked="" type="checkbox"/>	address parameter Index (IO-Link Device) 0..3;	
8	IOL_SUBINDEX	Int	14.0	INT#0	0	<input checked="" type="checkbox"/>	<input checked="" type="checkbox"/>	address parameter Subindex (IO-Link Device) 1	
9	LEN	Int	16.0	INT#0	0	<input checked="" type="checkbox"/>	<input checked="" type="checkbox"/>	length of writing data (netto data)	

Figure 34: Control data for read request via FB50001

Output									
Name	Data type	Offset	Start value	Monitor value	Retain	Visible in ...	Setpoint	Comment	
11	DONE_VALID	Bool	18.0	false	FALSE	<input checked="" type="checkbox"/>	<input checked="" type="checkbox"/>	validity 0: data invalid ; 1: data valid	
12	BUSY	Bool	18.1	false	FALSE	<input checked="" type="checkbox"/>	<input checked="" type="checkbox"/>	0: request finish ; 1: request in progress	
13	ERROR	Bool	18.2	false	FALSE	<input checked="" type="checkbox"/>	<input checked="" type="checkbox"/>	Error Flag = 0: no error; 1: function aborted with	
14	STATUS	DWord	20.0	DWord 16#00000000	16#0000_0000	<input checked="" type="checkbox"/>	<input checked="" type="checkbox"/>	DPI PNID - error status ; ERROR flag = 1 - comm	
15	IOL_STATUS	DWord	24.0	DWord 16#00000000	16#0001_0000	<input checked="" type="checkbox"/>	<input checked="" type="checkbox"/>	IO-Link error status; ERROR flag = 1: IO-Link erro	
16	RD_LEN	Int	28.0	INT#0	0	<input checked="" type="checkbox"/>	<input checked="" type="checkbox"/>	length of read data record (number of bytes)	

Figure 35: Status data for read request via FB50001

read									
Name	Data type	Offset	Start value	Monitor value	Retain	Visible in ...	Setpoint	Comment	
26	read	Struct	150.0			<input checked="" type="checkbox"/>	<input checked="" type="checkbox"/>	data area for reading data	
27	header	Struct	150.0			<input checked="" type="checkbox"/>	<input checked="" type="checkbox"/>		
28	data	Array[0..231] of Byte	158.0			<input checked="" type="checkbox"/>	<input checked="" type="checkbox"/>		
29	data[0]	Byte	158.0	16#0	16#74	<input checked="" type="checkbox"/>	<input checked="" type="checkbox"/>	'r'	
30	data[1]	Byte	159.0	16#0	16#65	<input checked="" type="checkbox"/>	<input checked="" type="checkbox"/>	'e'	
31	data[2]	Byte	160.0	16#0	16#73	<input checked="" type="checkbox"/>	<input checked="" type="checkbox"/>	's'	
32	data[3]	Byte	161.0	16#0	16#74	<input checked="" type="checkbox"/>	<input checked="" type="checkbox"/>	'r'	
33	data[4]	Byte	162.0	16#0	16#00	<input checked="" type="checkbox"/>	<input checked="" type="checkbox"/>		

Figure 36: Read data from application tag of the IO-Link Device via FB50001

8.5.2 SIEMENS WRREC and RDREC

The Reading and Writing Parameters from the PLC over the IOL-Master to the connected IOL-Device modules can also be handled by using the SIEMENS Function Blocks *SFB52/RDREC* and *SFB53/WRREC*.

8.5.2.1 Write sequence

The following figure shows the sequence of WRREC and RDREC calls for writing data:

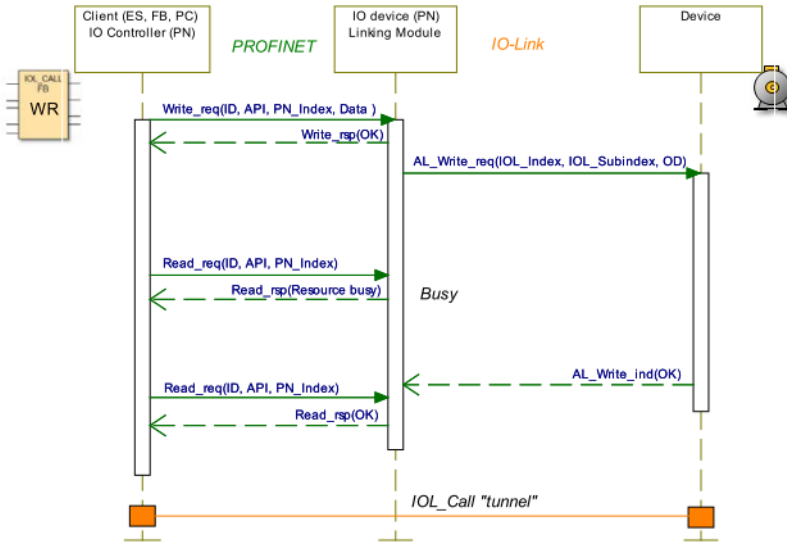

The following table shows the sequence with example data compared to the *FB50001*. The *FB50001* uses the WRREC and RDREC blocks also internally:

FB50001 Call	WRREC				RDREC	RDREC Response		
ID (address proxy)	ID (address proxy)				ID (address proxy)			
CAP	PN_Index = 0xB400				PN_Index = 0xB400			
WR	Data Header	Function (fixed)	0x08	Unsigned8		Data Header	Function (fixed)	0x08
Port		Port	1-8	Unsigned8			Port	1-8
		FI_Index (Fixed)	0xFE4A	Unsigned16			FI_Index (Fixed)	0xFE4A
		Control/Status (→Write)	0x02	Unsigned8			Control/Status	0x00
IOL-Index		IOL-Index (0-32767; 65535)	0x...	Unsigned16			IOL-Index (0-32767; 65535)	0x...
IOLSubIndex		IOL-Sub-Index (0-255)	0x00	Unsigned8			IOL-Sub-Index (0-255)	0x00
IOL-Data		WR-Data					Data (opt. Error PDU)	

Table 12: WRREC ID



Attention: Unsigned16 values must be entered in Big Endian format for PROFINET.

Bit 7	Bit 6	Bit 5	Bit 4	Bit3	Bit2	Bit 1	Bit 0	Definition of Control octets
0	0	0	0	0	0	0	0	Cancel / Release IOL_CALL
0	0	0	0	0	0	0	1	IDLE Sequence
0	0	0	0	0	0	1	0	Write On-request Data or Port function
0	0	0	0	0	0	1	1	Read On-request Data
Other codings								Reserved

Table 13: Control Parameter

Bit 7	Bit 6	Bit 5	Bit 4	Bit3	Bit2	Bit 1	Bit 0	Definition of Status octets
0	0	0	0	0	0	0	0	Done / Transfer terminated
0	0	0	0	0	0	0	1	IDLE Sequence
1	0	0	0	0	0	0	0	IOL_Error PDU
Other codings								Reserved

Table 14: Status Parameter

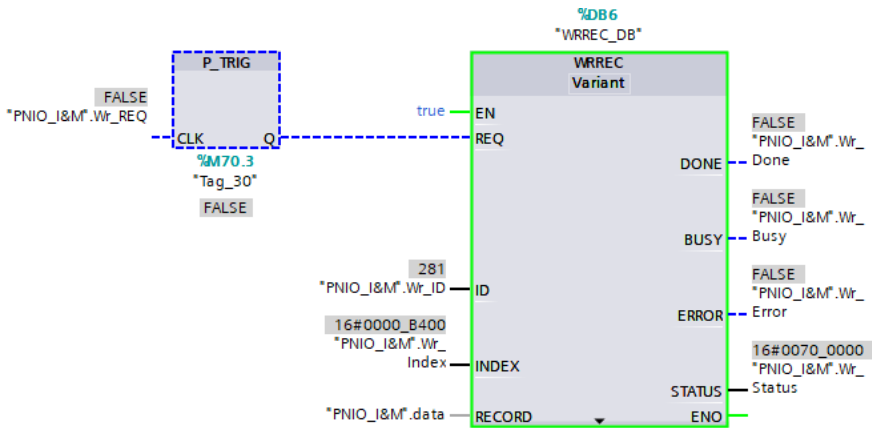

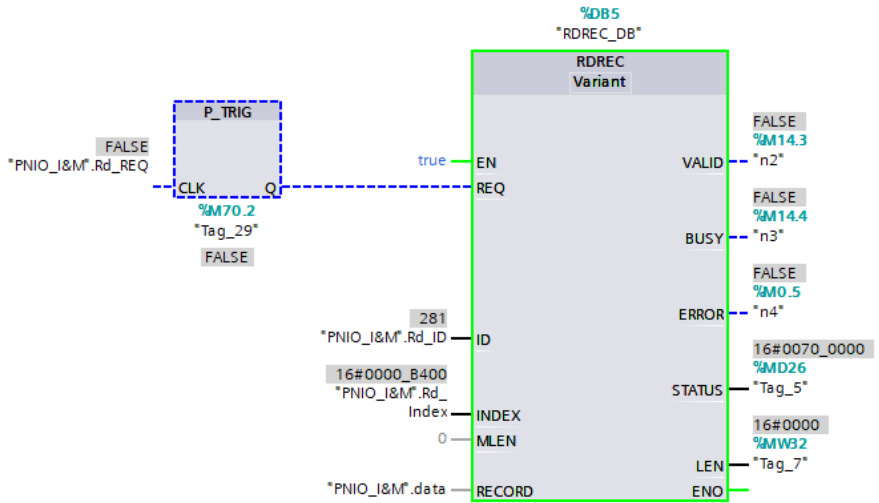

	Wr_REQ	Bool	false	FALSE
	Wr_Index	DWord	16#0	16#0000_B400
	Wr_ID	HW_IO	0	281
	Wr_Done	Bool	false	FALSE
	Wr_Busy	Bool	false	FALSE
	Wr_Error	Bool	false	FALSE
	Wr_Status	DWord	16#0	16#0000_0000
	Wr_Len	UInt	0	0
	data	Array[0..39] of Byte		
	data[0]	Byte	16#0	16#08
	data[1]	Byte	16#0	16#05
	data[2]	Byte	16#0	16#FE
	data[3]	Byte	16#0	16#4A
	data[4]	Byte	16#0	16#02
	data[5]	Byte	16#0	16#00
	data[6]	Byte	16#0	16#18
	data[7]	Byte	16#0	16#00
	data[8]	Byte	16#0	16#54
	data[9]	Byte	16#0	16#45
	data[10]	Byte	16#0	16#53
	data[11]	Byte	16#0	16#54
	data[12]	Byte	16#0	16#00
	data[13]	Byte	16#0	16#00
	data[14]	Byte	16#0	16#00
	data[15]	Byte	16#0	16#00
	data[16]	Byte	16#0	16#00
	data[17]	Byte	16#0	16#00

Figure 37: Example of data before writing





























	Wr_REQ	Bool	 false	TRUE
	Wr_Index	DWord	16#0	16#0000_B400
	Wr_ID	HW_IO	0	281
	Wr_Done	Bool	false	FALSE
	Wr_Busy	Bool	false	FALSE
	Wr_Error	Bool	false	FALSE
	Wr_Status	DWord	16#0	16#0000_0000
	Wr_Len	UInt	0	0
	▼ data	Array[0..39] of Byte		
	data[0]	Byte	16#0	16#08
	data[1]	Byte	16#0	16#05
	data[2]	Byte	16#0	16#FE
	data[3]	Byte	16#0	16#4A
	data[4]	Byte	16#0	16#02
	data[5]	Byte	16#0	16#00
	data[6]	Byte	16#0	16#18
	data[7]	Byte	16#0	16#00
	data[8]	Byte	16#0	16#54
	data[9]	Byte	16#0	16#45
	data[10]	Byte	16#0	16#53
	data[11]	Byte	16#0	16#54
	data[12]	Byte	16#0	16#00
	data[13]	Byte	16#0	16#00
	data[14]	Byte	16#0	16#00
	data[15]	Byte	16#0	16#00
	data[16]	Byte	16#0	16#00
	data[17]	Byte	16#0	16#00

Figure 38: Example of data after writing

Name	Data type	Start value	Monitor value
▼ Static			
■ Rd_REQ	Bool	false	TRUE
■ Rd_Index	DWord	16#0	16#0000_B400
■ Rd_ID	HW_IO	0	281
■ Rd_Valid	Bool	false	FALSE
■ Rd_Busy	Bool	false	FALSE
■ Rd_Error	Bool	false	FALSE
■ Rd_Status	DWord	16#0	16#0000_0000
■ Rd_Len	UInt	0	0
■ ▼ data	Array[0..39] of Byte		
■ data[0]	Byte	16#0	16#08
■ data[1]	Byte	16#0	16#05
■ data[2]	Byte	16#0	16#FE
■ data[3]	Byte	16#0	16#4A
■ data[4]	Byte	16#0	16#00
■ data[5]	Byte	16#0	16#00
■ data[6]	Byte	16#0	16#18
■ data[7]	Byte	16#0	16#00
■ data[8]	Byte	16#0	16#54
■ data[9]	Byte	16#0	16#45
■ data[10]	Byte	16#0	16#53
■ data[11]	Byte	16#0	16#54
■ data[12]	Byte	16#0	16#00
■ data[13]	Byte	16#0	16#00
■ data[14]	Byte	16#0	16#00
■ data[15]	Byte	16#0	16#00
■ data[16]	Byte	16#0	16#00
■ data[17]	Byte	16#0	16#00

Figure 39: Read data after writing

8.5.2.2 Read sequence

The following figure shows the sequence of WRREC and RDREC calls for reading data:

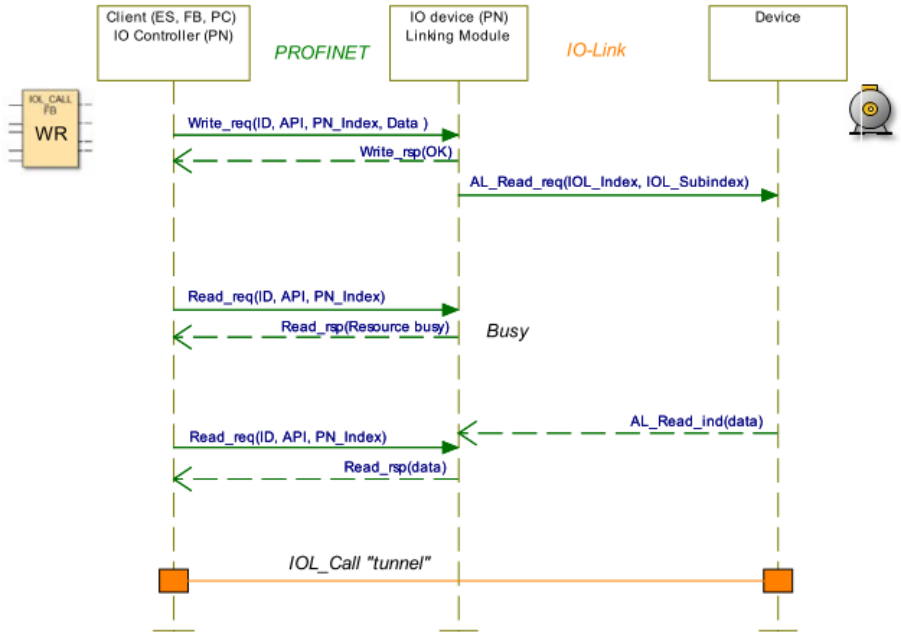

The following table shows the sequence with example data compared to the *FB50001*. The *FB50001* uses the WRREC and RDREC blocks also internally:

FB50001 Call	WRREC				RDREC	RDREC Response		
ID (address proxy)	ID (address proxy)				ID (address proxy)			
CAP	PN_Index = 0xB400				PN_Index = 0xB400			
WR	Data Header	Function (fixed)	0x08	Unsigned8		Data Header	Function (fixed)	0x08
Port		Port	1-8	Unsigned8			Port	1-8
		FI_Index (Fixed)	0xFE4A	Unsigned16			FI_Index (Fixed)	0xFE4A
		Control/Status (→Read)	0x03	Unsigned8			Control/Status	0x00
IOL-Index		IOL-Index (0-32767; 65535)	0x...	Unsigned16			IOL-Index (0-32767; 65535)	0x...
IOLSubIndex		IOL-Sub-Index (0-255)	0x00	Unsigned8			IOL-Sub-Index (0-255)	0x00
IOL-Data		–					Data (opt. Error PDU)	

Table 15: RDREC ID



Attention: Unsigned16 values must be entered in Big Endian format for PROFINET.

Bit 7	Bit 6	Bit 5	Bit 4	Bit3	Bit2	Bit 1	Bit 0	Definition of Control octets
0	0	0	0	0	0	0	0	Cancel / Release IOL_CALL
0	0	0	0	0	0	0	1	IDLE Sequence
0	0	0	0	0	0	1	0	Write On-request Data or Port function
0	0	0	0	0	0	1	1	Read On-request Data
Other codings								Reserved

Table 16: Control Parameter

Bit 7	Bit 6	Bit 5	Bit 4	Bit3	Bit2	Bit 1	Bit 0	Definition of Status octets
0	0	0	0	0	0	0	0	Done / Transfer terminated
0	0	0	0	0	0	0	1	IDLE Sequence
1	0	0	0	0	0	0	0	IOL_Error PDU
Other codings								Reserved

Table 17: Status Parameter

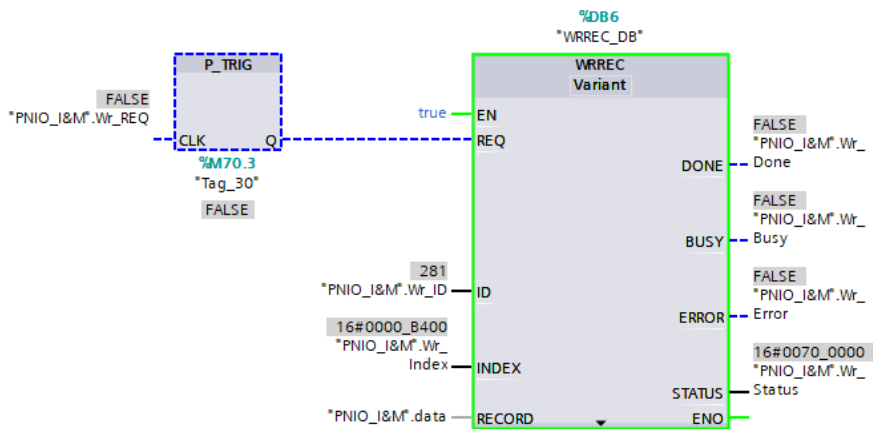

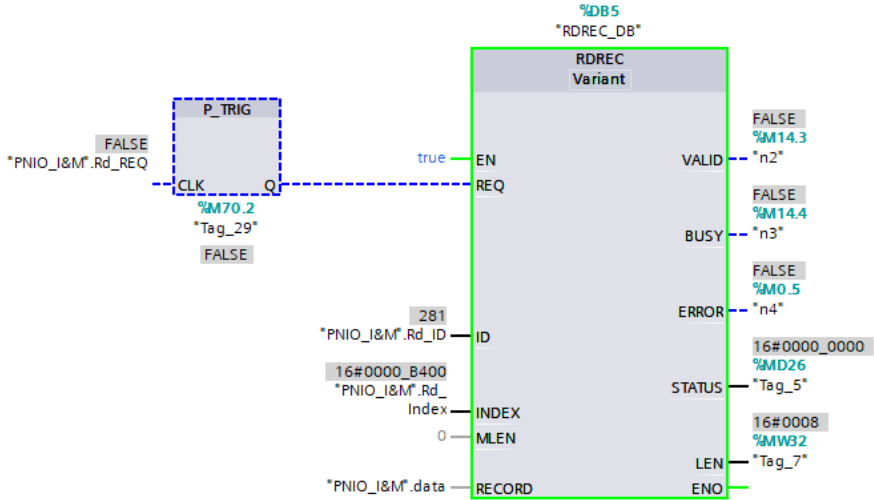

Static				
Bool	Rd_REQ	Bool	false	FALSE
DWord	Rd_Index	DWord	16#0	16#0000_B400
HW_IO	Rd_ID	HW_IO	0	281
Bool	Rd_Valid	Bool	false	FALSE
Bool	Rd_Busy	Bool	false	FALSE
Bool	Rd_Error	Bool	false	FALSE
DWord	Rd_Status	DWord	16#0	16#0000_0000
UInt	Rd_Len	UInt	0	0
Bool	Wr_REQ	Bool	false	FALSE
DWord	Wr_Index	DWord	16#0	16#0000_B400
HW_IO	Wr_ID	HW_IO	0	281
Bool	Wr_Done	Bool	false	FALSE
Bool	Wr_Busy	Bool	false	FALSE
Bool	Wr_Error	Bool	false	FALSE
DWord	Wr_Status	DWord	16#0	16#0000_0000
UInt	Wr_Len	UInt	0	0
data		Array[0..39] of Byte		
Byte	data[0]	Byte	16#0	16#08
Byte	data[1]	Byte	16#0	16#05
Byte	data[2]	Byte	16#0	16#FE
Byte	data[3]	Byte	16#0	16#4A
Byte	data[4]	Byte	16#0	16#03
Byte	data[5]	Byte	16#0	16#00
Byte	data[6]	Byte	16#0	16#18
Byte	data[7]	Byte	16#0	16#00
Byte	data[8]	Byte	16#0	16#00
Byte	data[9]	Byte	16#0	16#00
Byte	data[10]	Byte	16#0	16#00
Byte	data[11]	Byte	16#0	16#00
Byte	data[12]	Byte	16#0	16#00
Byte	data[13]	Byte	16#0	16#00
Byte	data[14]	Byte	16#0	16#00
Byte	data[15]	Byte	16#0	16#00
Byte	data[16]	Byte	16#0	16#00
Byte	data[17]	Byte	16#0	16#00

Figure 40: Example of data before reading



























	Wr_REQ	Bool	false	TRUE
	Wr_Index	DWord	16#0	16#0000_B400
	Wr_ID	HW_IO	0	281
	Wr_Done	Bool	false	FALSE
	Wr_Busy	Bool	false	FALSE
	Wr_Error	Bool	false	FALSE
	Wr_Status	DWord	16#0	16#0000_0000
	Wr_Len	UInt	0	0
	▼ data	Array[0..39] of Byte		
	data[0]	Byte	16#0	16#08
	data[1]	Byte	16#0	16#05
	data[2]	Byte	16#0	16#FE
	data[3]	Byte	16#0	16#4A
	data[4]	Byte	16#0	16#03
	data[5]	Byte	16#0	16#00
	data[6]	Byte	16#0	16#18
	data[7]	Byte	16#0	16#00
	data[8]	Byte	16#0	16#00
	data[9]	Byte	16#0	16#00
	data[10]	Byte	16#0	16#00
	data[11]	Byte	16#0	16#00
	data[12]	Byte	16#0	16#00
	data[13]	Byte	16#0	16#00
	data[14]	Byte	16#0	16#00
	data[15]	Byte	16#0	16#00
	data[16]	Byte	16#0	16#00
	data[17]	Byte	16#0	16#00

Figure 41: Example of data after reading

Name	Data type	Start value	Monitor value
▼ Static			
Rd_REQ	Bool	false	TRUE
Rd_Index	DWord	16#0	16#0000_B400
Rd_ID	HW_IO	0	281
Rd_Valid	Bool	false	FALSE
Rd_Busy	Bool	false	FALSE
Rd_Error	Bool	false	FALSE
Rd_Status	DWord	16#0	16#0000_0000
Rd_Len	UInt	0	0
▼ data	Array[0..39] of Byte		
data[0]	Byte	16#0	16#08
data[1]	Byte	16#0	16#05
data[2]	Byte	16#0	16#FE
data[3]	Byte	16#0	16#4A
data[4]	Byte	16#0	16#00
data[5]	Byte	16#0	16#00
data[6]	Byte	16#0	16#18
data[7]	Byte	16#0	16#00
data[8]	Byte	16#0	16#54
data[9]	Byte	16#0	16#45
data[10]	Byte	16#0	16#53
data[11]	Byte	16#0	16#54
data[12]	Byte	16#0	16#00
data[13]	Byte	16#0	16#00
data[14]	Byte	16#0	16#00
data[15]	Byte	16#0	16#00
data[16]	Byte	16#0	16#00
data[17]	Byte	16#0	16#00

Figure 42: Read data after reading

8.5.2.3 Error PDU for the Read/Write sequence

Offset	Parameter	Content	Data type
0	Port Error	Error Codes detected by the Linking Module or Client	Unsigned16
2	Error Code	IO-Link Error codes according AL_Read/ AL_Write services	Unsigned8
3	Additional Code	IO-Link Error codes according AL_Read/ AL_Write services	Unsigned8

Table 18: Error PDU

Port Error Code	Definition	Coding	Originator
No error	No error detected	0x0000	Server
Reserved	–	0x0001 to 0x06FFF	–
IOL_CALL conflict	Inconsistent Header information	0x7000	Server and/or Client
Incorrect IOL_CALL	Inconsistent Header information (send-/response)	0x7001	Server and/or Client
Port blocked	Port temporary not available	0x7002	Server
Reserved	–	0x7003 to 0x7FFF	–
Timeout	No correct termination of IOL_CALL (Resource Busy detection)	0x8000	Client
Invalid port number	Invalid port Number or port not supported	0x8001	Client and/or Server
Invalid IOL_Index	Invalid Index	0x8002	Client
Invalid IOL_Subindex	Invalid Subindex	0x8003	Client
No Device	No device	0x8004	Client
Reserved	–	0x8005 to 0x8051	–
RDREC Fault	Fault during Read record invocation	0x8052	Client
WRREC Fault	Fault during Write record invocation	0x8053	Client
Unexpected Error	Unspecific Error detected	0x8054	Client
Port Function error	Port function failed	0x8055	Server

Port Error Code	Definition	Coding	Originator
Port Function not available	Port function is not available (in this state)	0x8056	Server
Port Function not supported	Port function (for this port) not supported	0x8057	Server
Manu	Manufacturer specific	0x8058 to 0xFFFF	Server

Table 19: Port Error of Error PDU

8.6 Media Redundancy Protocol (MRP)

Redundant PROFINET communication can be implemented with the LioN-X devices via a ring topology without the use of additional switches. An MRP redundancy manager terminates the ring, detects individual failures, and transmits the data packets on the redundant path in case of error.

The following conditions must be met to use MRP:

- ▶ All devices must support MRP.
- ▶ MRP must be enabled on all devices.
- ▶ Connections to the devices are only possible via the ring ports. A mesh topology is not permissible.
- ▶ A max. of 50 devices are permissible in the ring.
- ▶ All devices share the same redundancy domain.
- ▶ One device must be configured as the redundancy manager.
- ▶ All other devices must be configured as redundancy clients.
- ▶ Prioritized boot (FSU) is permissible.
- ▶ The response monitoring time of all devices must be greater than the reconfiguration time (typically 200 ms, min. 90 ms for LioN-X devices).
- ▶ It is recommended to use automatic network settings on all devices.

The following figures show a possible MRP ring configuration. The PLC is used as the redundancy manager while all other devices are clients. To detect an individual failure, it is advisable to use the diagnostics alerts.

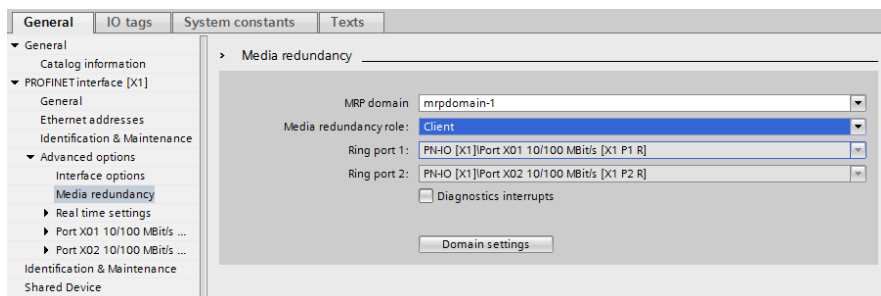

Figure 43: Example of setting up an MRP redundancy client in TIA Portal®

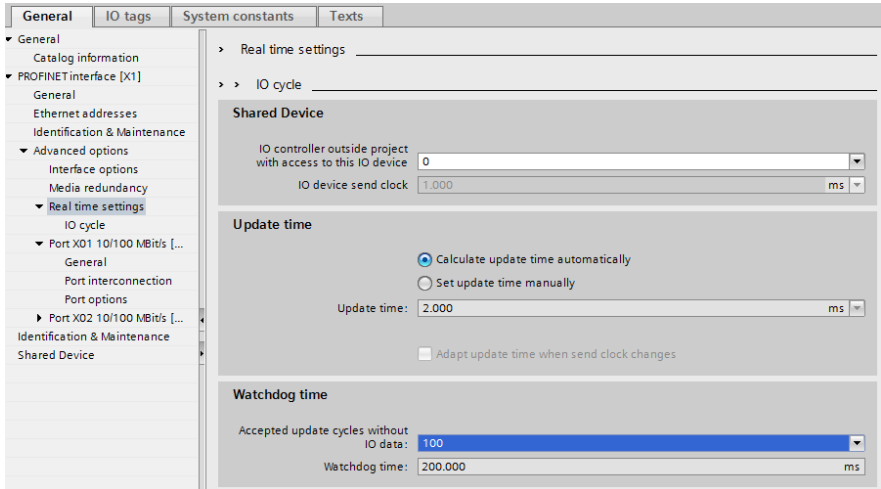

Figure 44: Example of setting up the Watchdog time monitoring in TIA Portal® for using MRP

8.7 Identification & maintenance (I&M)

The PROFINET IO-Link Master has the ability to uniquely identify the devices installed in the system via an electronic nameplate. This device-specific data can be read acyclic by the user at any time. Furthermore, the installation date, location code and further descriptions can be stored in the device during installing the system. The I&M functions provide the following functionality.

8.7.1 Supported I&M features

8.7.1.1 I&M data of the PN-IO Device

For reading (I&M 0 - 3) and writing (I&M 1 - 3) I&M data, the appropriate Hardware identifier for Slot 0: **PROFINET Interface X1** must be chosen:

The screenshot displays the TIA Portal interface. On the left, a physical device is shown with a label '0980-XSL-3912-12...'. The main window shows the 'Device overview' table:

Module	Rack	Slot	I address	Q address	Type
0980-XSL-3912-121-007D	0	0: PROFINET Interface			0980 XSL 3912-12...
PN-IO	0	0: PROFINET Interface X1			0980-XSL-3912-12...
Port X01 10/100 Mbit/s	0	0: PROFINET Interface X1 X1P1			Port X01 10/100 M...
Port X02 10/100 Mbit/s	0	0: PROFINET Interface X1 X1P2			Port X02 10/100 M...
IO-Link Master_1	0	1: IO System 1.			IO-Link Master
Status/Control Module	0	1: IO System 1. 1	1...2	1...2	Status/Control Mod...
IO-Link I/O 4/4 Bytes + P...	0	1: IO System 1. 2: Port X1	68...72	64...67	IO-Link I/O 4/4 Byte...
Digital In (A) / Digital (B)	0	1: IO System 1. 3: Port X2	73		Digital In (A) / Digit...
Digital In (A) / Digital (B)_1	0	1: IO System 1. 4: Port X3	74		Digital In (A) / Digit...
Digital In (A) / Digital (B)_2	0	1: IO System 1. 5: Port X4	75		Digital In (A) / Digit...
Digital In (A) / Digital (B)_3	0	1: IO System 1. 6: Port X5	76		Digital In (A) / Digit...
Digital In (A) / Digital (B)_4	0	1: IO System 1. 7: Port X6	77		Digital In (A) / Digit...
Digital In (A) / Digital (B)_5	0	1: IO System 1. 8: Port X7	78		Digital In (A) / Digit...
Digital In (A) / Digital (B)_6	0	1: IO System 1. 9: Port X8	79		Digital In (A) / Digit...

Below the table, the 'Properties' window for 'PN-IO [PN-IO]' is open, showing the 'System constants' tab:

Name	Type	Hardware identi.	Used by	Comment
0980-XSL-3912-121-007D-PN-IO-Port_X01_10_100_MBit/s	Hw_Interface	277	PLC_1	
0980-XSL-3912-121-007D-PN-IO-Port_X02_10_100_MBit/s	Hw_Interface	278	PLC_1	
0980-XSL-3912-121-007D-PN-IO	Hw_Interface	276	PLC_1	

Figure 45: TIA Portal® hardware identifier of PROFINET interface for I&M 0-3 RDREC/WRREC

The device-specific I&M features can be read (0-3) or written (1-3) via slot 0. The specified index is used for mapping the data sets.

Data object	Length [byte]	Access	Default value / Description
MANUFACTURER_ID	2	Read	0x016A (Belden Deutschland GmbH)
ORDER_ID	20	Read	Order number of module in ASCII
SERIAL_NUMBER	16	Read	Defined in production process in ASCII
HARDWARE_REVISION	2	Read	Hardware revision of device
SOFTWARE_REVISION	4	Read	Software revision of device
REVISION_COUNTER	2	Read	Incremented for every statically stored parameter change on IO-Link Master (e.g., device name or IP address)
PROFILE_ID	2	Read	0xF600 (Generic device)
PROFILE_SPECIFIC_TYPE	2	Read	0x0003 (IO modules)
IM_VERSION	2	Read	0x0101 (I&M Version 1.1)
IM_SUPPORTED	2	Read	0x000E (I&M 1 ... 3 & 5 is supported)

Table 20: I&M 0 (Slot 0: PROFINET Interface X1, Index 0xAFF0)

Data object	Length [byte]	Access	Default value / Description
TAG_FUNCTION	32	Read/ Write	0x20 ff. (empty)
TAG_LOCATION	22	Read/ Write	0x20 ff. (empty)

Table 21: I&M 1 (Slot 0: PROFINET Interface X1, Index 0xAFF1)

Data object	Length [byte]	Access	Default value / Description
INSTALLATION_DATE	16	Read/ Write	0x20 ff. (empty); Supported data format is a visible string with a fix length of 16 byte; "YYYY-MM-DD hh:mm" or "YYYY-MM-DD" filled with blank spaces

Table 22: I&M 2 (Slot 0: PROFINET Interface X1, Index 0xAFF2)

Data object	Length [byte]	Access	Default value / Description
DESCRIPTOR	54	Read/ Write	0x20 ff. (empty)

Table 23: I&M 3 (Slot 0: PROFINET Interface X1, Index 0xAFF3)

8.7.1.2 I&M data of the IOL-Master proxy (Status/Control Module)

For reading I&M 0 data, the appropriate hardware identifier for Slot 1: IO System 1.1 must be chosen:

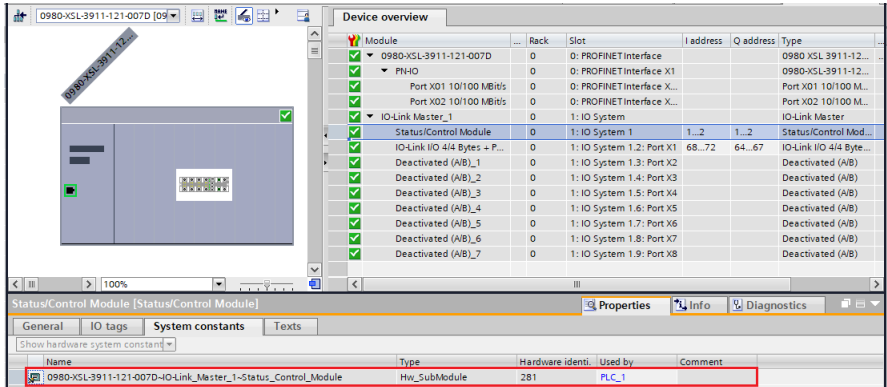

Figure 46: Hardware identifier of the Status/Control Module for RDREC "IO System 1"

Data object	Length [byte]	Access	Default value / Description
MANUFACTURER_ID	2	Read	0x016A (Belden Deutschland GmbH)
ORDER_ID	20	Read	Order number of module in ASCII
SERIAL_NUMBER	16	Read	Defined in production process in ASCII
HARDWARE_REVISION	2	Read	Hardware revision of device
SOFTWARE_REVISION	4	Read	Software revision of device
REVISION_COUNTER	2	Read	Incremented for every statically stored parameter change on IO-Link Master (e.g., device name or IP address)
PROFILE_ID	2	Read	0x4E01 (IOL-Master proxy)
PROFILE_SPECIFIC_TYPE	2	Read	0x0000 (unspecified)
IM_VERSION	2	Read	0x0101 (I&M Version 1.1)
IM_SUPPORTED	2	Read	0x0000

Table 24: I&M 0 (Slot 1: IO System 1.1, Index 0xAFF0)

8.7.1.3 I&M data of the IOL-Device proxy

The IO-Link Device-specific *I&M 0* and *I&M 5* data can be read via slot 1 and the appropriate sub-slot (**1.2/Port X1 ...1.9/Port X8**). The specified index is used for mapping the data sets. Only data not equal to zero are received if a connection to an IO-Link Device can be established.

The screenshot displays the Siemens TIA Portal interface. On the left, a 3D model of a rack is shown with a callout for '0980-XSL-3911-121'. The main window shows the 'Device overview' table, which lists modules and their properties. The 'Status/Control Module' is highlighted in blue. Below the table, the 'System constants' table is visible, showing the hardware identifier for the selected module.

Module	Rack	Slot	I address	Q address	Type
0980-XSL-3911-121-007D	0	0	0: PROFINET Interface		0980 XSL 3911-12...
PN-IO	0	0	0: PROFINET Interface X1		0980-XSL-3911-12...
Port X01 10/100 Mbits	0	0	0: PROFINET Interface X...		Port X01 10/100 M...
Port X02 10/100 Mbits	0	0	0: PROFINET Interface X...		Port X02 10/100 M...
IO-Link Master_1	0	1: IO System			IO-Link Master
Status/Control Module	0	1: IO System 1	1...2	1...2	Status/Control Mod...
IO-Link I/O 4/4 Bytes + P...	0	1: IO System 1.2: Port X1	68...72	64...67	IO-Link I/O 4/4 Byte...
Deactivated (AIB)_1	0	1: IO System 1.3: Port X2			Deactivated (AIB)
Deactivated (AIB)_2	0	1: IO System 1.4: Port X3			Deactivated (AIB)
Deactivated (AIB)_3	0	1: IO System 1.5: Port X4			Deactivated (AIB)
Deactivated (AIB)_4	0	1: IO System 1.6: Port X5			Deactivated (AIB)
Deactivated (AIB)_5	0	1: IO System 1.7: Port X6			Deactivated (AIB)
Deactivated (AIB)_6	0	1: IO System 1.8: Port X7			Deactivated (AIB)
Deactivated (AIB)_7	0	1: IO System 1.9: Port X8			Deactivated (AIB)

Name	Type	Hardware identi.	Used by	Comment
0980-XSL-3911-121-007D-IO-Link_Master_1-IO-Link_I_0_4_Bytes_+PQL...	Hw_SubModule	282	PLC_1	

Figure 47: Hardware identifier of the Status/Control module for RDREC "IO System 1.2"

I&M0 data	Octets	Data type	Mapping rules
VendorID	2	Unsigned16	IO-Link Direct parameter page 1: VendorID. Direct mapping, for example "0x136". Exceptions: 1 → 93; 26 → 257; 87 → 467.
OrderID	20	Visible String	"Product Name" or "DeviceID".
IM_Serial_Number	16	Visible String	Insert SerialNumber of Device (IO-Link Index 21). If it is not available set to "Not accessible".
IM_Hardware_Revision	2	Unsigned8	Set to 0x0000 (Default value)
IM_Software_Revision	4	Char,3 x Unsigned8	Set to V0.0.0 (official release but not detectable)
IM_RevisionCounter	2	Unsigned16	Set to "0" (0x0000)
IM_Profile_ID	2	Unsigned16	IO-Link (API = 0x4E01)
IM_Profile_Specific_Type	2	Unsigned16	Set to "0" (0x0000)
IM_Version	2	2 x Unsigned8	Octet 1 (MSB): set to 0x01 Octet 2 (LSB): set to 0x00
IM_Supported	2	Unsigned16 (Bit Array)	Profile specific I&M: 0x0000 (Bit 0 for I&M0 is always 0)

Table 25: I&M 0 (Slot 1: IO System 1.2 - 1.9, Index 0xAFF0)

I&M5 data	Octets	Data type	Mapping rules
IM_Annotation	64	String (UTF8)	"IO-Link Devices"
IM_OrderID	64	Visible String	"Product Name" or "DeviceID".
IM_VendorID	2	Unsigned16	"VendorID"
IM_Serial_Number	16	Visible String	Insert SerialNumber of device (IO-Link Index 21). If it is not available, set to "Not accessible".
IM_Hardware_Revision	2	Unsigned8	Set to 0x0000 (default value)
IM_Software_Revision	4	Char,3 x Unsigned8	Set to V0.0.0 (official release but not detectable)

Table 26: I&M 5 (Slot 1: IO System 1.2 - 1.9, Index 0xAFF5)

Name	Data type	Monitor value	Retain	Comment
Static				
Rd_Req	Bool	FALSE	<input type="checkbox"/>	
Rd_Index	DWord	16#0000_AFF5	<input type="checkbox"/>	
RD_Id	HW_IO	282	<input type="checkbox"/>	
Rd_Req_Len	UInt	0	<input type="checkbox"/>	
Rd_Valid	Bool	FALSE	<input type="checkbox"/>	
Rd_Busy	Bool	FALSE	<input type="checkbox"/>	
Rd_error	Bool	FALSE	<input type="checkbox"/>	
Rd_Status	DWord	16#0000_00A6	<input type="checkbox"/>	
Rd_Res_Len	UInt	0	<input type="checkbox"/>	
byte	Array[0..329] of Byte		<input type="checkbox"/>	
byte[0]	Byte	16#00	<input type="checkbox"/>	BlockType High: I&M5 = 0x0025
byte[1]	Byte	16#25	<input type="checkbox"/>	BlockType Low: I&M5 = 0x0025
byte[2]	Byte	16#00	<input type="checkbox"/>	BlockLength High: I&M = 0x00A2
byte[3]	Byte	16#A2	<input type="checkbox"/>	BlockLength Low: I&M5 = 0x00A2 (162 dez)
byte[4]	Byte	16#01	<input type="checkbox"/>	BlockVersion High: 1
byte[5]	Byte	16#00	<input type="checkbox"/>	BlockVersion Low: 0
byte[6]	Byte	16#00	<input type="checkbox"/>	NumberOfEntries: High
byte[7]	Byte	16#01	<input type="checkbox"/>	NumberOfEntries: Low
byte[8]	Byte	16#00	<input type="checkbox"/>	BlockType Low I&M5 Data
byte[9]	Byte	16#34	<input type="checkbox"/>	BlockType High I&M5 Data
byte[10]	Byte	16#00	<input type="checkbox"/>	BlockLength Low I&M5 Data = 0x009A
byte[11]	Byte	16#9A	<input type="checkbox"/>	BlockLength Low I&M5 Data = 0x009A (154 dez)
byte[12]	Byte	16#01	<input type="checkbox"/>	BlockVersion High: 1
byte[13]	Byte	16#00	<input type="checkbox"/>	BlockVersion Low: 0
byte[14]	Byte	16#49	<input type="checkbox"/>	IM Annotation "IO-Link Devices"
byte[15]	Byte	16#4F	<input type="checkbox"/>	
byte[16]	Byte	16#2D	<input type="checkbox"/>	

Figure 48: Read example I&M5 on port X1 with connected IOL-Device

8.7.2 Reading and writing I&M data

In its standard library, SIEMENS offers TIA Portal® system function modules that allow I&M data to be read and written. A data set contains a 6-byte *BlockHeader* and the I&M record.

The data requested on reading, or the data to be written thus only start after the existing header. For writing, the header content must additionally be taken into account. [Table 27: Data set with BlockHeader and I&M Record](#) on page 111 shows the structure of a data set.

- ▶ For reading I&M 0..3, the RDREC block must be configured with `LEN = 6 Byte Block Header + I&M data length`.
- ▶ For reading I&M 5, the RDREC block must be configured with `LEN = 6 Byte Block Header + 8 Byte I&M + I&M data length`.

Data object	Length [byte]	Data type	Coding	Description
BlockType	2	Word	I&M 0: 0x0020 I&M 1: 0x0021 I&M 2: 0x0022 I&M 3: 0x0023 I&M 5: 0x0025	BlockHeader
BlockLength	2	Word	I&M 0: 0x0038 I&M 1: 0x0038 I&M 2: 0x0012 I&M 3: 0x0038 I&M 5: 0x0098	
BlockVersionHigh	1	Byte	0x01	
BlockVersionLow	1	Byte	0x00	
I&M Data	I&M 0: 54 I&M 1: 54 I&M 2: 16 I&M 3: 54 I&M 5: 152	Byte		I&M Record

Table 27: Data set with BlockHeader and I&M Record

8.7.2.1 I&M Read Record

I&M data can be read via the standard RDREC (SFB52) function block in the **Siemens PLC**. The logical address of the slot/sub-slot (ID) and the I&M index (INDEX) must be used as handover parameters. The return parameters show the length of the I&M data received, and contain a status or error message.

	Name	Data type	Start value	Monitor value	Comment
1	Static				
2	Rd_Req	Bool	false	FALSE	
3	Rd_Index	DWord	16#0000AFF0	16#0000_AFF0	
4	Rd_Id	HW_IO	279	279	
5	Rd_Req_Len	UInt	0	0	
6	Rd_Valid	Bool	false	FALSE	
7	Rd_Busy	Bool	false	FALSE	
8	Rd_Error	Bool	false	FALSE	
9	Rd_Status	DWord	16#0	16#0000_0000	
10	Rd_Res_Len	UInt	0	60	
11	byte	Array[0..60] of Byte			
12	byte[0]	Byte	16#00	16#00	BlockType High: I&M0 = 0x0020
13	byte[1]	Byte	16#20	16#20	BlockType Low: I&M0 = 0x0020
14	byte[2]	Byte	16#00	16#00	BlockLength High: I&M0 = 0x0038
15	byte[3]	Byte	16#38	16#38	BlockLength Low: I&M0 = 0x0038
16	byte[4]	Byte	16#01	16#01	BlockVersion High: 1
17	byte[5]	Byte	16#0	16#00	BlockVersion Low: 0
18	byte[6]	Byte	16#0	16#01	Data: Vendor ID High of connected IOL-Device
19	byte[7]	Byte	16#0	16#6A	Data: Vendor ID Low of connected IOL-Device
20	byte[8]	Byte	16#0	16#39	Data: Order ID 1 (935 700 001)
21	byte[9]	Byte	16#0	16#33	Data: Order ID
22	byte[10]	Byte	16#0	16#35	Data: Order ID
23	byte[11]	Byte	16#0	16#20	Data: Order ID
24	byte[12]	Byte	16#0	16#37	Data: Order ID
25	byte[13]	Byte	16#0	16#30	Data: Order ID
26	byte[14]	Byte	16#0	16#30	Data: Order ID
27	byte[15]	Byte	16#0	16#20	Data: Order ID
28	byte[16]	Byte	16#0	16#30	Data: Order ID
29	byte[17]	Byte	16#0	16#30	Data: Order ID
30	byte[18]	Byte	16#0	16#31	Data: Order ID
31	byte[19]	Byte	16#0	16#20	Data: Order ID
32	byte[20]	Byte	16#0	16#20	Data: Order ID

Figure 49: Read example I&M0 of PROFINET IO device

	Name	Data type	Start value	Monitor value	Comment
1	Static				
2	Rd_Req	Bool	false	FALSE	
3	Rd_Index	DWord	16#0000AFF0	16#0000_AFF0	
4	Rd_Id	HW_ID	282	282	
5	Rd_Req_Len	UInt	0	0	
6	Rd_Valid	Bool	false	FALSE	
7	Rd_Busy	Bool	false	FALSE	
8	Rd_error	Bool	false	FALSE	
9	Rd_Status	DWord	16#0	16#0000_0000	
10	Rd_Res_Len	UInt	0	60	
11	byte	Array[0..60] of Byte			
12	byte[0]	Byte	16#00	16#00	BlockType High: I&M = 0x0020
13	byte[1]	Byte	16#20	16#20	Block Type Low: I&M = 0x0020
14	byte[2]	Byte	16#00	16#00	BlockLength High: I&M = 0x0038
15	byte[3]	Byte	16#38	16#38	BlockLength Low: I&M = 0x0038
16	byte[4]	Byte	16#01	16#01	BlockVersion High: 1
17	byte[5]	Byte	16#0	16#00	BlockVersion Low: 0
18	byte[6]	Byte	16#0	16#00	Data: Vendor ID High of connected IOL-Device
19	byte[7]	Byte	16#0	16#02	Data: Vendor ID Low of connected IOL-Device
20	byte[8]	Byte	16#0	16#31	Data: Order ID 1 (1732-L....)
21	byte[9]	Byte	16#0	16#37	Data: Order ID
22	byte[10]	Byte	16#0	16#33	Data: Order ID
23	byte[11]	Byte	16#0	16#32	Data: Order ID
24	byte[12]	Byte	16#0	16#49	Data: Order ID
25	byte[13]	Byte	16#0	16#4C	Data: Order ID

Figure 50: Read example I&M0 on port X1 with connected IOL-Device

Name	Data type	Start value	Snapshot	Monitor value	Retain	Comment
1 Static						
2 Rd_Req	Bool	false	FALSE	FALSE	<input type="checkbox"/>	
3 Rd_Index	DWord	16#0000AFF5	16#0000_AFF5	16#0000_AFF5	<input type="checkbox"/>	
4 RD_Id	HW_IO	282	282	282	<input type="checkbox"/>	
5 Rd_Req_Len	UInt	0	0	0	<input type="checkbox"/>	
6 Rd_Valid	Bool	false	FALSE	FALSE	<input type="checkbox"/>	
7 Rd_Busy	Bool	false	FALSE	FALSE	<input type="checkbox"/>	
8 Rd_error	Bool	false	FALSE	FALSE	<input type="checkbox"/>	
9 Rd_status	DWord	16#0	16#0000_00A6	16#0000_00A6	<input type="checkbox"/>	
10 Rd_Res_Len	UInt	0	0	0	<input type="checkbox"/>	
11 byte	Array[0..165] of Byte				<input type="checkbox"/>	
12 byte[0]	Byte	16#00	16#00	16#00	<input type="checkbox"/>	BlockType High: I&M5 = 0x0025
13 byte[1]	Byte	16#0	16#25	16#25	<input type="checkbox"/>	BlockType Low: I&M5 = 0x0025
14 byte[2]	Byte	16#00	16#00	16#00	<input type="checkbox"/>	BlockLength High: I&M = 0x00A2
15 byte[3]	Byte	16#0	16#A2	16#A2	<input type="checkbox"/>	BlockLength Low: I&M5 = 0x00A2 (162 dez)
16 byte[4]	Byte	16#0	16#01	16#01	<input type="checkbox"/>	BlockVersion High: 1
17 byte[5]	Byte	16#0	16#00	16#00	<input type="checkbox"/>	BlockVersion Low: 0
18 byte[6]	Byte	16#0	16#00	16#00	<input type="checkbox"/>	NumberOfEntries: High
19 byte[7]	Byte	16#0	16#01	16#01	<input type="checkbox"/>	NumberOfEntries: Low
20 byte[8]	Byte	16#0	16#00	16#00	<input type="checkbox"/>	BlockType Low I&M5 Data
21 byte[9]	Byte	16#0	16#34	16#34	<input type="checkbox"/>	BlockType High I&M5 Data
22 byte[10]	Byte	16#0	16#00	16#00	<input type="checkbox"/>	BlockLength Low I&M5 Data = 0x009A
23 byte[11]	Byte	16#0	16#9A	16#9A	<input type="checkbox"/>	BlockLength High I&M5 Data = 0x009A (154 dez)
24 byte[12]	Byte	16#0	16#01	16#01	<input type="checkbox"/>	BlockVersion High: 1
25 byte[13]	Byte	16#0	16#00	16#00	<input type="checkbox"/>	BlockVersion Low: 0
26 byte[14]	Byte	16#0	16#49	16#49	<input type="checkbox"/>	IMAnnotation "IO-Link Devices"
27 byte[15]	Byte	16#0	16#4F	16#4F	<input type="checkbox"/>	
28 byte[16]	Byte	16#0	16#2D	16#2D	<input type="checkbox"/>	
29 byte[17]	Byte	16#0	16#4C	16#4C	<input type="checkbox"/>	
30 byte[18]	Byte	16#0	16#69	16#69	<input type="checkbox"/>	
31 byte[19]	Byte	16#0	16#6E	16#6E	<input type="checkbox"/>	
32 byte[20]	Byte	16#0	16#6B	16#6B	<input type="checkbox"/>	
33 byte[21]	Byte	16#0	16#14	16#20	<input type="checkbox"/>	
34 byte[22]	Byte	16#0	16#44	16#44	<input type="checkbox"/>	

Figure 51: Read example I&M5 on port X1 with connected IOL-Device

8.7.2.2 I&M Write Record

I&M data can be written via the standard WRREC (SFB53) function block in the **Siemens PLC**. The logical address of the slot/sub-slot (ID), the I&M index (INDEX) and the data length (LEN) must be used as handover parameters. The return parameters contain a status or error message.

	Name	Data type	Start value	Monitor value	Comment
1	Static				
2	Wr_Req	Bool	false	FALSE	
3	Wr_Index	DWord	16#0000AFF1	16#0000_AFF1	
4	Wr_Id	HW_IO	279	279	
5	Wr_Req_Len	UInt	0	0	
6	Wr_Done	Bool	false	FALSE	
7	Wr_Busy	Bool	false	FALSE	
8	Wr_Error	Bool	false	FALSE	
9	Wr_Status	DWord	16#0	16#0000_0000	
10	Wr_Res_Len	UInt	0	0	
11	byte	Array[0..59] of Byte			
12	byte[0]	Byte	16#00	16#00	BlockType High: I&M1 = 0x0021
13	byte[1]	Byte	16#21	16#21	Block Type Low: I&M1 = 0x0021
14	byte[2]	Byte	16#00	16#00	BlockLength High: 0 for I&M 1
15	byte[3]	Byte	16#38	16#38	BlockLength Low: 0x38 for I&M 1
16	byte[4]	Byte	1	16#01	BlockVersion High: 1
17	byte[5]	Byte	16#0	16#00	BlockVersion Low: 0
18	byte[6]	Byte	16#61	16#61	Data: "a"
19	byte[7]	Byte	16#62	16#62	Data: "b"
20	byte[8]	Byte	16#63	16#63	Data: "c"
21	byte[9]	Byte	16#64	16#64	Data: "d"
22	byte[10]	Byte	16#0	16#00	
23	byte[11]	Byte	16#0	16#00	
24	byte[12]	Byte	16#0	16#00	

Figure 52: Example of a completed I&M1 write action of a PROFINET IO device

8.8 Fast Start Up (FSU) / Prioritized Startup

The LioN-X devices with Fast Start-Up (FSU) support an optimized system start-up. This guarantees a faster restart after the power supply is restored.

Fast Start-Up can be activated for the LioN-X devices with **PROFINET interface [X1] > Advanced options > Interface options** over **Prioritized start-up**.

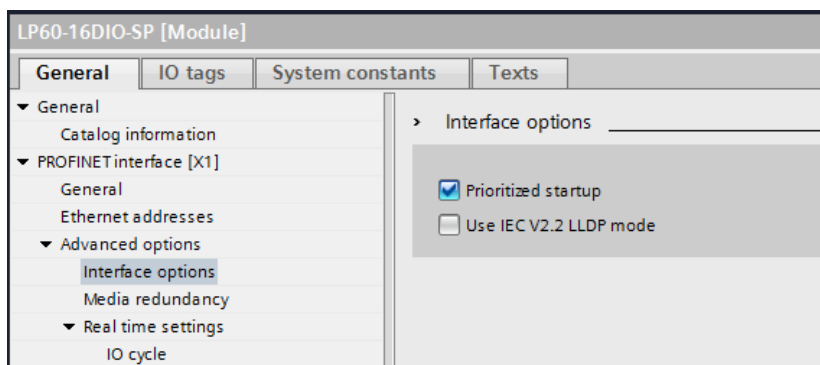

For better FSU performance, the transmission settings of ports X01 and X02 should be set to:

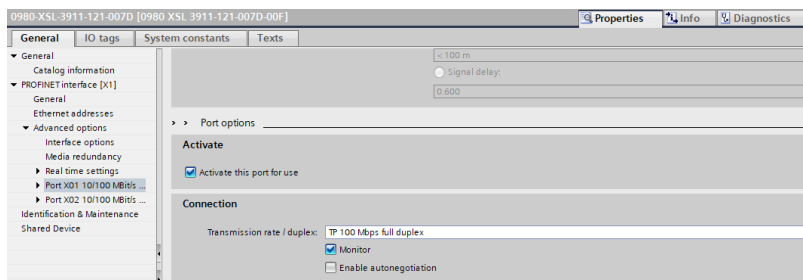

Attention: The settings for the local and the partner port must be identical.

Measured boot times

PROFINET FSU time:¹⁾

< 2200 ms

Start time **with** FSU activated:²⁾

0980 XSL... variants: ~2400 ms

0980 LSL... variants: ~12000 ms

Start time **without** FSU activated:²⁾

0980 XSL... variants: ~5400 ms

0980 LSL... variants: ~16000 ms

1) Measured according to specification: Internal switch is able to forward telegrams.

2) PLC reads one digital input and sets one digital output on IO-Link Master after power-up of the DUT (IO-Link Master). PLC is connected directly to DUT port X01 without any additional switch between PLC and DUT.

8.9 Suspend / Resume of IO-Link port operation

8.9.1 Automatic tool changer application use case

Depending on the state of a production process, a tool change inside of a machine is required by undocking a particular tool, for example a gripper, in a magazine and docking another one. This docking and undocking comprise mechanical joint and electrical connections for power supply as well as for communication.

With the following IO-Link calls (e.g. via a Siemens FB50001)

- ▶ Suspend port operation
- ▶ Resume port operation

the IO-Link port operation can be changed dynamically during the cyclic data exchange.

8.9.2 Concept

The basic concept of the user function "Suspend Port operation" is to suppress the entire PROFINET fault indications to the system/user, since it concerns an intended action. In essence, after the suspension all pending diagnosis messages of the related Port and device are deleted.

The current Port status is always visible to the user via the flag bit "PortActive" in the "Port Qualifier Information – PQI". Three activities characterize the port operations:

- ▶ Automatic Port operation
- ▶ Suspend Port operation
- ▶ Resume Port operation

Automatic Port operation

The following activities will turn a port automatically into state "Port operation resumed", indicated by flag bit "PortActive" = 1:

- ▶ Power-on of the IO-Link Device or Master
- ▶ Configuration change of the IOL-Master port
- ▶ Port configuration mode set to Digital Input or Digital Output

Suspend/Resume Port operation

Figure 53: Suspend/Resume Port operation on page 119 provides an overview of the mechanisms and serves as visualization of the following actions:

- ▶ Successfully suspended Port operation leads to flag bit indication "PortActive" = 0 and "DevErr" = 0.
- ▶ Undocking of the Tool/Device leads to flag bits "PQ" = 0 and "DevCom" = 0
- ▶ Docking of a "new" Tool/Device leads to flag bits "PQ" = 1 and "DevCom" = 1
- ▶ Successfully resumed Port operation leads to flag bit indication "PortActive" = 1

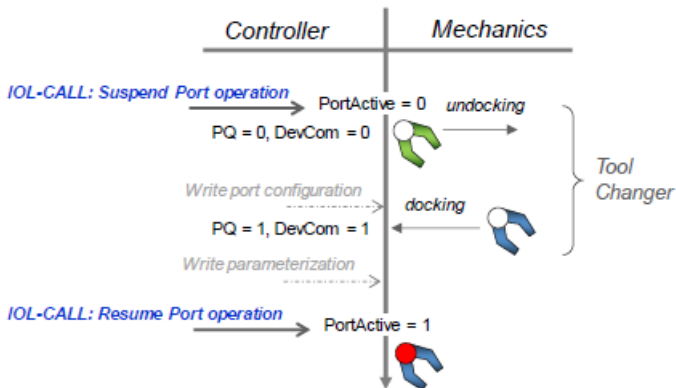

Figure 53: Suspend/Resume Port operation

8.9.3 Use cases

Use case	Inspection level (Backup & Restore)	Description
No. 1: A Device will be replaced by a Device of the same type with identical parameters.	0: no Device check 1: type compatible Device (V1.0) 2: type compatible Device (V1.1) 3: type compatible Device (V1.1) with Backup + Restore 4: type compatible Device (V1.1) with Restore	All Inspection Levels are permitted in use case No. 1. Recommended: type compatible Device V1.1 with Backup + Restore
No. 2: A Device will be replaced by a Device of the same type with different parameters.	0: no device check 1: type compatible Device (V1.0) 2: type compatible Device (V1.1)	Backup and Restore not reasonable in use case No. 2. Recommended: type compatible Device (V1.0 or V1.1)
No. 3: A Device will be replaced by a Device of a different type.	0: no Device check 1: type compatible Device (V1.0) 2: type compatible Device (V1.1)	Backup and Restore not reasonable in use case No. 3. Recommended: type compatible Device (V1.0 or V1.1)

- ▶ Port configuration can be adapted while in state "Port operation suspended" (use case no. 3).
- ▶ Additionally, the parameterization of the Device can be adapted after active Communication (DevCom =1) through control program (use case no. 2).
- ▶ Especially in use case no. 2 and no. 3 it is recommended to deactivate the Backup & Restore function for a better transparency and start-up performance.

8.9.4 Suspend and Resume cycle

For a complete Suspend and Resume cycle the following read and write requests must be performed step by step.

After writing the commands Suspend or Resume, the successful execution of the command must be verified by the appropriate read request.

8.9.4.1 Write Record Suspend – port command

The following example illustrates how to suspend an IO-Link port operation with the TIA WRREC function block:

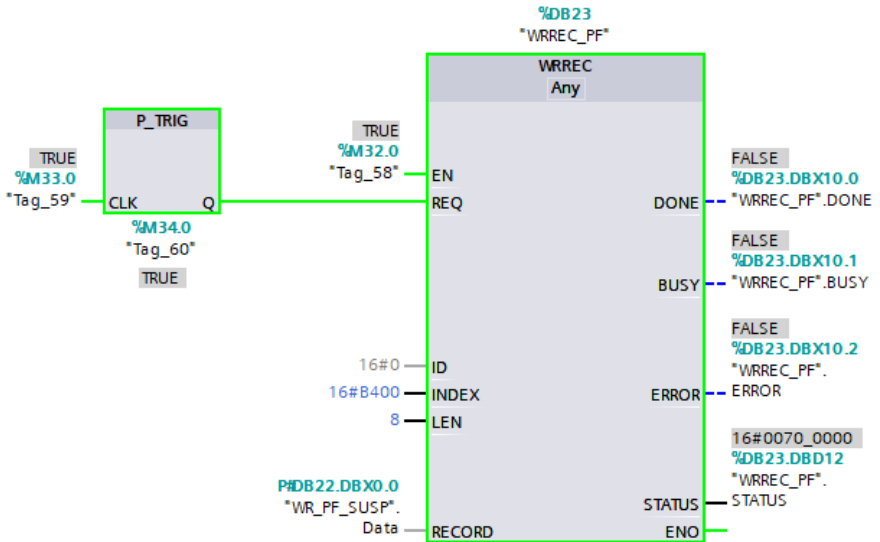

ID = 0 for addressing the IO-Link Master proxy

INDEX = 0xB400

LEN = 8 Bytes for command

	Name	Data type	Offset	Start value	Comment
1	Static				
2	Data	Array[0..59] of Byte	0.0		
3	Data[0]	Byte	0.0	16#8	Call Header
4	Data[1]	Byte	1.0	16#1	Port Number (1... 8)
5	Data[2]	Byte	2.0	16#FE	Call Fixed
6	Data[3]	Byte	3.0	16#4A	Call Fixed
7	Data[4]	Byte	4.0	16#02	Call Write
8	Data[5]	Byte	5.0	16#FF	Index Port Command
9	Data[6]	Byte	6.0	16#FF	Index Port Command
10	Data[7]	Byte	7.0	16#3	Command Suspend

Figure 54: WRREC data

8.9.4.2 Read Record Suspend – port status

Use this read request to verify that the previous writing of the suspend port command has been performed successfully.

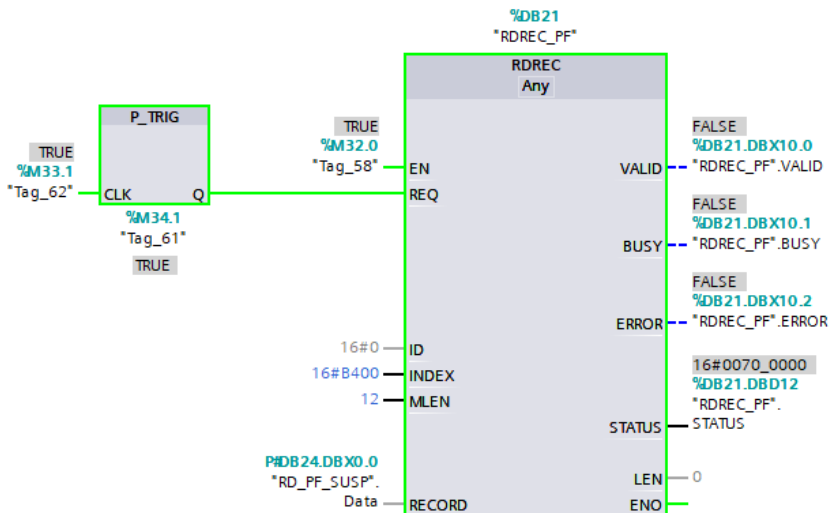

ID = 0 for addressing the IO-Link Master proxy

INDEX = 0xB400

LEN = 12 bytes, 8 bytes for command + 4 bytes for error PDU

If the suspend port command has been performed successfully, the read data look the following:

	Name	Data type	Offset	Start value	Monitor value	Comment
1	Static					
2	Data	Array[0..11] of Byte	0.0			
3	Data[0]	Byte	0.0	16#0	16#08	Call Header
4	Data[1]	Byte	1.0	16#0	16#01	Port Number (1..8)
5	Data[2]	Byte	2.0	16#0	16#FE	Call Fixed
6	Data[3]	Byte	3.0	16#0	16#4A	Call Fixed
7	Data[4]	Byte	4.0	16#0	16#00	Status 0x00 = OK, 0x80 = Error PDU
8	Data[5]	Byte	5.0	16#0	16#FF	Index Port Command
9	Data[6]	Byte	6.0	16#0	16#FF	Index Port Command
10	Data[7]	Byte	7.0	16#0	16#03	Command Suspend
11	Data[8]	Byte	8.0	16#0	16#00	Error PDU
12	Data[9]	Byte	9.0	16#0	16#00	Error PDU
13	Data[10]	Byte	10.0	16#0	16#00	SMI Job Error
14	Data[11]	Byte	11.0	16#0	16#00	SMI Job Error

The IO-Link Device can be disconnected now.

If the suspend process has not been finished on the IO-Link Master before the read record is received, a negative PROFINET response will be sent with the code "Resource busy – 0x80C2".

Possible error PDU codes:

NO_ERROR	0x0000
IOL_CALL_CONFLICT	0x7000
INCORRECT_IOL_CALL	0x7001
PORT_BLOCKED	0x7002
TIMEOUT	0x8000
INVALID_PORT_NUMBER	0x8001
INVALID_IOL_INDEX	0x8002
INVALID_IOL_SUBINDEX	0x8003
NO_DEVICE	0x8004
DECODE_ERROR	0x8051
RDREC_FAULT	0x8052
WREC_FAULT	0x8053
UNEXPECTED_ERROR_SEQ	0x8054

Possible error PDU codes:

FUNCTION_ERROR	0x8055
FUNCTION_NOT_AVAILABLE	0x8056
FUNCTION_NOT_SUPPORTED	0x8057

8.9.4.3 Write Record Resume – port command

The following example illustrates how to resume an IO-Link port operation with the TIA WRREC function block (after the IO-Link Device has been connected successfully):

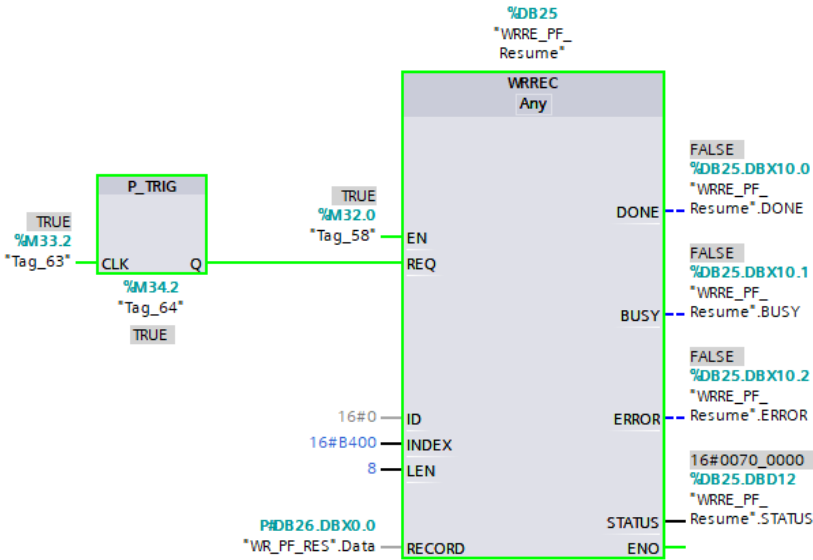

	Name	Data type	Offset	Start value	Comment
1	Static				
2	Data	Array[0..31] of Byte	0.0		
3	Data[0]	Byte	0.0	16#8	Call Header
4	Data[1]	Byte	1.0	16#1	Port Number (1...8)
5	Data[2]	Byte	2.0	16#FE	Call Fixed
6	Data[3]	Byte	3.0	16#4A	Call Fixed
7	Data[4]	Byte	4.0	16#02	Call Write
8	Data[5]	Byte	5.0	16#FF	Index Port Command
9	Data[6]	Byte	6.0	16#FF	Index Port Command
10	Data[7]	Byte	7.0	16#4	Command Resume = 0x04

Figure 55: WRREC data

8.9.4.4 Read Record Resume – port status

Use this read request to verify that the previous writing of the resume port command has been performed successfully.

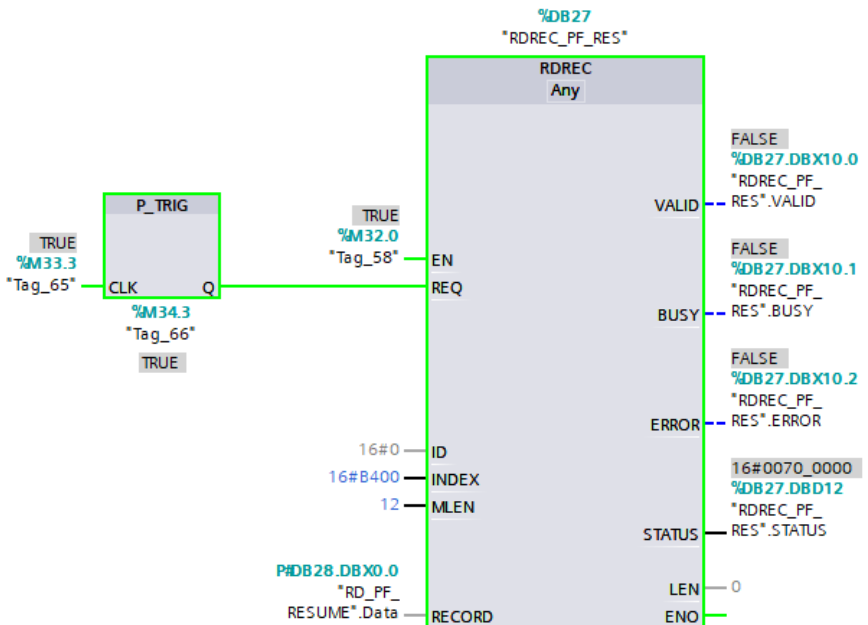

ID = 0 for addressing the IO-Link Master proxy

INDEX = 0xB400

LEN = 12 bytes, 8 bytes for command + 4 bytes for error PDU

If the resume port command has been performed successfully, the read data look the following:

	Name	Data type	Offset	Start value	Monitor value	Comment
1	Static					
2	Data	Array[0..231] of Byte	0.0			
3	Data[0]	Byte	0.0	16#0	16#08	Call Header
4	Data[1]	Byte	1.0	16#0	16#01	Port Number (1..8)
5	Data[2]	Byte	2.0	16#0	16#FE	Call Fixed
6	Data[3]	Byte	3.0	16#0	16#4A	Call Fixed
7	Data[4]	Byte	4.0	16#0	16#00	Status: 0x00=OK, 0x80 = Error PDU
8	Data[5]	Byte	5.0	16#0	16#FF	Index Port Command
9	Data[6]	Byte	6.0	16#0	16#FF	Index Port Command
10	Data[7]	Byte	7.0	16#0	16#04	Command Resume
11	Data[8]	Byte	8.0	16#0	16#00	Error PDU
12	Data[9]	Byte	9.0	16#0	16#00	Error PDU
13	Data[10]	Byte	10.0	16#0	16#00	SM Job Error
14	Data[11]	Byte	11.0	16#0	16#00	SM Job Error

If the resume process has not been finished on the IO-Link Master before the read record is received, a negative PROFINET response will be sent with the code "Resource busy – 0x80C2".

Possible error PDU codes:

NO_ERROR	0x0000
IOL_CALL_CONFLICT	0x7000
INCORRECT_IOL_CALL	0x7001
PORT_BLOCKED	0x7002
TIMEOUT	0x8000
INVALID_PORT_NUMBER	0x8001
INVALID_IOL_INDEX	0x8002
INVALID_IOL_SUBINDEX	0x8003
NO_DEVICE	0x8004
DECODE_ERROR	0x8051

Possible error PDU codes:

RDREC_FAULT	0x8052
WREC_FAULT	0x8053
UNEXPECTED_ERROR_SEQ	0x8054
FUNCTION_ERROR	0x8055
FUNCTION_NOT_AVAILABLE	0x8056
FUNCTION_NOT_SUPPORTED	0x8057

9 Process data assignment

The LioN-X IO-Link Master uses a modular device model. Slot 1/sub-slot 1 contains the Status/Control module of the IO-Link Master. The module has 2 bytes of input data and 2 bytes of output data. It is always statically configured when selecting a LioN-X IO-Link Master from the GSD file.

The IO-Link ports use the following sub-slots 2 through 9 of slot 1; they can have a different operating mode and data length depending on the configuration.

9.1 Process data Status/Control Module, I/O system 1.1

The Status/Control Module has one Unsigned16 (UINT16/Word) for digital input data and one Unsigned16 (UINT16/Word) for digital output data.

Status Data (input)

The two input bytes (Unsigned16) contain the status of the digital inputs. For the digital A-channel inputs, the data are also available in the input byte of the appropriate sub-slot module.

Control Data (output)

The two output bytes (Unsigned16) contain the control bits for the digital outputs of the B-channels.

For controlling the digital A-Channels, the output *Byte 1/Bit 0* of the appropriate sub-slot module must be used.

With the *General Device Settings* parameter *Digital Out Ch. A Controlled By: Status/Control Module* the control can be switched to the *Control Bits*. In this case, the outputs cannot be controlled by the sub-slot output *Byte 1/Bit 0*.

The digital output can be controlled only by one data source.

Parameter Dependencies for Digital-I/O data mapping

Please refer to chapter [I/O mapping configuration of Status/Control data](#) on page 59 for the Bit Mapping

The screenshot shows the 'IO Mapping Configuration of Status/Control Data' window. The left sidebar contains a tree view with the following items:

- General
 - Catalog information
 - Module parameters
 - General Device Settings
 - IO Mapping Configuration of Status/Co...**
 - General Diagnostic Settings
 - Module failure
 - IO addresses

The main area is titled 'IO Mapping Configuration of Status/Control Data' and contains a table with the following columns and rows:

Port	Channel	Order of Status/Control IO Data
Port X1	Ch. A (IOL/DI/DO)	UIN16 High-Byte / Bit 0
Port X1	Ch. B (—/DI/DO)	UIN16 High-Byte / Bit 1
Port X2	Ch. A (IOL/DI/DO)	UIN16 High-Byte / Bit 2
Port X2	Ch. B (—/DI/DO)	UIN16 High-Byte / Bit 3
Port X3	Ch. A (IOL/DI/DO)	UIN16 High-Byte / Bit 4
Port X3	Ch. B (—/DI/DO)	UIN16 High-Byte / Bit 5
Port X4	Ch. A (IOL/DI/DO)	UIN16 High-Byte / Bit 6
Port X4	Ch. B (—/DI/DO)	UIN16 High-Byte / Bit 7
Port X5	Ch. A (IOL/DI/DO)	UIN16 Low-Byte / Bit 0
Port X5	Ch. B (—/DI/DO)	UIN16 Low-Byte / Bit 1
Port X6	Ch. A (IOL/DI/DO)	UIN16 Low-Byte / Bit 2
Port X6	Ch. B (—/DI/DO)	UIN16 Low-Byte / Bit 3
Port X7	Ch. A (IOL/DI/DO)	UIN16 Low-Byte / Bit 4
Port X7	Ch. B (—/DI/DO)	UIN16 Low-Byte / Bit 5
Port X8	Ch. A (IOL/DI/DO)	UIN16 Low-Byte / Bit 6
Port X8	Ch. B (—/DI/DO)	UIN16 Low-Byte / Bit 7

9.1.1 Status/Control data with Bit Mapping

The described bit mapping status/control examples are exclusively valid for the following device variants:

- ▶ LioN-X 0980 XSL 3912-121-007D-00F
- ▶ LioN-X 0980 XSL 3912-121-007D-01F

For details on bit mapping configuration, see chapters [I/O mapping configuration of Status/Control data](#) on page 59 and [I/O port overview](#) on page 21.

Key

X1A = Port 1, Channel A

UINT16 High-Byte = 1st / low address byte in a Siemens PLC

UINT16 Low-Byte = 2nd / high address byte in a Siemens PLC

(applicable for a Siemens PLC using Big-Endian format)

9.1.1.1 Mode 1

(example for 0980 XSL 3912-121-007D-00F)

I/O	Status/ Control	Bit 7	Bit 6	Bit 5	Bit 4	Bit 3	Bit 2	Bit 1	Bit 0
Status/ Control Slot 1.1	UINT16 High-Byte	X8B	X8A	X7B	X7A	X6B	X6A	X5B	X5A
	UINT16 Low-Byte	X4B	X4A	X3B	X3A	X2B	X2A	X1B	X1A

Table 28: Digital Input/Output Mapping Mode 1

9.1.1.2 Mode 2

(example for 0980 XSL 3912-121-007D-00F)

Default from GSDML-V2.35-BeldenDeutschland-LioN-X-20211022 and higher; prior versions have "Mode 1" as default.

I/O	Status/ Control	Bit 7	Bit 6	Bit 5	Bit 4	Bit 3	Bit 2	Bit 1	Bit 0
Status/ Control Slot 1.1	UINT16 High-Byte	X4B	X4A	X3B	X3A	X2B	X2A	X1B	X1A
	UINT16 Low-Byte	X8B	X8A	X7B	X7A	X6B	X6A	X5B	X5A

*Table 29: Digital Input/Output Mapping Mode 2***9.1.1.3 Mode 3**

(example for 0980 XSL 3912-121-007D-00F)

I/O	Status/ Control	Bit 7	Bit 6	Bit 5	Bit 4	Bit 3	Bit 2	Bit 1	Bit 0
Status/ Control Slot 1.1	UINT16 High-Byte	X8B	X7B	X6B	X5B	X4B	X3B	X2B	X1B
	UINT16 Low-Byte	X8A	X7A	X6A	X5A	X4A	X3A	X2A	X1A

Table 30: Digital Input/Output Mapping Mode 3

9.1.1.4 Mode 4

(example for 0980 XSL 3912-121-007D-00F)

I/O	Status/ Control	Bit 7	Bit 6	Bit 5	Bit 4	Bit 3	Bit 2	Bit 1	Bit 0
Status/ Control Slot 1.1	UINT16 High-Byte	X8A	X7A	X6A	X5A	X4A	X3A	X2A	X1A
	UINT16 Low-Byte	X8B	X7B	X6B	X5B	X4B	X3B	X2B	X1B

Table 31: Digital Input/Output Mapping Mode 4

9.1.1.5 Mode 5

The mapping for this mode depends on the user settings.

9.1.1.6 PROFINET channel diagnostics mapping

Port	X8	X7	X6	X5	X4	X3	X2	X1
I/O Pin	2/4	2/4	2/4	2/4	2/4	2/4	2/4	2/4
I/O Channel	B/A	B/A	B/A	B/A	B/A	B/A	B/A	B/A
PN Diagn. Channel	8	7	6	5	4	3	2	1

Table 32: PROFINET channel diagnostics mapping

9.2 Process data IO-Link ports, Slot 1.2 – 1.9

The process data lengths of the IO-Link ports in COM mode depend on the IO-Link port configurations X1 – X8. Data lengths between 1 – 33 bytes of input data and/or 1 – 32 bytes of output data are configurable.

The data content can be taken from the descriptions of the IO-Link Devices. If a precise data length is not available for the IO-Link Device configuration, always select the next larger data length.

The last byte of the port input data contains the PQI byte (Port Qualifier Information). This byte is added to the IOL-Device input data by the IOL-Master.

Ch. A configuration as Digital Input

If the Port is configured as digital input, the port data length is one byte and the digital input status will be set on bit 0. The digital input status will also be mapped to the status bytes of the Status/Control Module.

The mapping mode selected for the Status/Control Module has no influence on the process data of the IO-Link ports.

INPUT	Input	Bit 7	Bit 6	Bit 5	Bit 4	Bit 3	Bit 2	Bit 1	Bit 0
Slot 1.2	X1 Byte 1 – 33	▶ If the IO-Link Port is in "Digital-In" Mode, the "DI-C/Q" state (Channel A, Pin 4) will be set in Bit 0 of Byte 1. In this case no PQI Byte is available. ▶ The last Byte contains the PQI (Port Qualifier Information).							
Slot 1.3	X2 Byte 1 – 33								
Slot 1.4	X3 Byte 1 – 33								
Slot 1.5	X4 Byte 1 – 33								
Slot 1.6	X5 Byte 1 – 33								
Slot 1.7	X6 Byte 1 – 33								
Slot 1.8	X7 Byte 1 – 33								
Slot 1.9	X8 Byte 1 – 33								

Table 33: Input data: Sub-slots 1.2 – 1.9

Bit	Acronym	Short Description	Value	Description
0	–	Reserved	0	Reserved
			–	–
1	–	Reserved	0	Reserved
			–	–
2	NewParam	New parameter	0	<i>Not supported yet, don't evaluate this bit!</i>
			1	<i>Not supported yet, don't evaluate this bit!</i>
3	SubstDev	Substitute Device detection	0	<i>Not supported yet, don't evaluate this bit!</i>
			1	<i>Not supported yet, don't evaluate this bit!</i>
4	PortActive	Port operation	0	port deactivated via port function
			1	port activated (default)
5	DevCom	Device communication	0	no IOL-Device available
			1	IOL-Device detected and is in PREOPERATE or OPERATE state
6	DevErr	Port/Device error indication	0	no error/warning occurred
			1	error/warning assigned to IOL-Device or IOL-Master port occurred
7	PQ	Device Process Data validity	0	invalid I/O process data from IOL-Device
			1	valid I/O process data from device

Table 34: PQI description

OUTPUT	Output	Bit 7	Bit 6	Bit 5	Bit 4	Bit 3	Bit 2	Bit 1	Bit 0
Slot 1.2	X1 Byte 1 – 32	▶ optional / If IO-Link Port is in "Digital-Out" Mode, the "DO-C/Q" state (Channel A, Pin 4) will be set in Bit 0 of Byte 1.							
Slot 1.3	X2 Byte 1 – 32								
Slot 1.4	X3 Byte 1 – 32								
Slot 1.5	X4 Byte 1 – 32								
Slot 1.6	X5 Byte 1 – 32								
Slot 1.7	X6 Byte 1 – 32								
Slot 1.8	X7 Byte 1 – 32								
Slot 1.9	X8 Byte 1 – 32								

Table 35: Output data: Sub-slots 1.2 – 1.9

Ch. A configuration as Digital Output

If the Port is configured as digital output, the port data length is one byte (one byte with digital output control in bit 0).

If the *General device* parameter *Digital Out Ch. A Controlled by* is set to "Status/Control Module", the output cannot be controlled by bit 0 in the port output byte.

10 Diagnostics

10.1 Detailed diagnostics description

10.1.1 Error of the system/sensor power supply U_S

The voltage value for the incoming system/sensor power supply is monitored globally for the IO-Link Master. If the voltage drops below approx. 18 V, or exceeds approx. 30 V, an error message is generated. The IO-Link specification requires at least 20 V at the L+ (pin1) output supply of the I/O ports. At least 21 V of U_S supply voltage for the IO-Link Master are required to minimize the risk of internal voltage drops in the IO-Link Master.



Caution: It must definitely be ensured that the supply voltage, measured at the most remote participant is not below 21 V DC from the perspective of the system power supply.

The following IO-Link Master diagnostic is generated:

Channel number of diagnostic	0x8000 (diagnostic not channel-specific)
Channel related diagnostic code	0x0002
Channel related diagnostic code message	Undervoltage

- ▶ For **disabled** U_S supply voltage fault alarms, the U_S indicator LED is "off" in case of voltage drops below approx. 18 V.
- ▶ For **enabled** U_S supply voltage fault alarms, the U_S indicator LED is "red" in case of voltage drops below approx. 18 V.

10.1.2 Error of the actuator power supply U_L

For the following device variants, the digital outputs are supplied by U_L power:

- ▶ 0980 XSL 3912-121-007D-00F
- ▶ 0980 XSL 3912-121-007D-01F

The voltage value for the incoming U_L power supply is monitored globally for the IO-Link Master. If U_L supply voltage alarms are enabled, an error message is generated in case the voltage drops below approx. 18 V or exceeds approx. 30 V.

If output channels are active, additional error messages caused by the voltage failure are generated on the I/O ports. U_L supply voltage alarms are disabled by default and can be enabled via parameterization.

The following IO-Link Master diagnostic is generated:

Channel number of diagnostic	0x8000 (diagnostic not channel-specific)
Channel related diagnostic code	0x0118
Channel related diagnostic code message	Low voltage or over voltage of actuator power supply (U_L)
Extended description	Check wire connection and U_L power supply inclusive tolerance

- ▶ For **disabled** U_L supply voltage fault alarms, the U_L indicator LED is "off" in case of voltage drops below approx. 18 V.
- ▶ For **enabled** U_L supply voltage fault alarms, the U_L indicator LED is "red" in case of voltage drops below approx. 18 V.

10.1.3 Overload/short-circuit of the I/O port sensor supply outputs

In case of an overload or a short circuit between pin 1 (L+) and pin 3 (GND) on the ports (X1 .. X8), the following channel-specific diagnostic messages are generated:

Channel number of diagnostics	0x01 - 0x08
Channel related diagnostic code	0x1806
Channel related diagnostic code message	Short circuit at L+
Extended description	Short circuit on sensor power supply at pin 1 (L+) of I/O port. Check wire connection.

- The dedicated red port DIA indicator is active when an error is detected.

10.1.4 Overload/short circuit of the I/O port Ch. A as actuator outputs

The digital outputs on the Channel A (C/Q / pin 4) are protected against short circuits and overloads. In case of a fault, the output is automatically switched to "inactive" and then cyclically switched back to "active" when the default setting is used (DO Restart Mode Parameter = "Automatic Restart after Failure").

In DO Restart Mode Parameter = "Restart after Output Reset", the output must be set to "low" via PLC, before the output can be set again to "high".

When an output channel is activated (rising edge of the channel state), the channel errors are filtered for the period that you set using the *Surveillance-Timeout* parameter during the configuration of the device. The value of this parameter can range from 0 to 255 ms; the factory setting is 80 ms.

The filter is used to avoid premature error messages when a capacitive load is activated.

The device sends the following PROFINET diagnostic message in the case of a fault:

Channel number of diagnostics	0x01 - 0x08
Channel related diagnostic code	0x1811
Channel related diagnostic code message	Short circuit at C/Q
Extended description	Short circuit or overload on digital output at pin 4 / Ch.A of IOL port in DIO mode. Check wire connection and also power supply

- The dedicated red port DIA indicator is active when an error is detected.



Attention: For variants 0980 XSL 3912-121-007D-00F and 0980 XSL 3912-121-007D-01F, the digital outputs are **supplied by the U_L power**.



Attention: For variants 0980 LSL 3010-121-0006-001 and 0980 LSL 3011-121-0006-001 , the digital outputs are **supplied by the U_S power**.

10.1.5 Overload/short circuit of the I/O port Ch. B as actuator outputs

Digital outputs on Channel B (I/Q / pin 2) are only applicable for the following device variants:

- ▶ 0980 XSL 3912-121-007D-00F
- ▶ 0980 XSL 3912-121-007D-01F

The digital outputs on the Channel B (I/Q / pin 2) are protected against short circuits and overloads. In case of a fault, the output is automatically switched to "inactive" and then cyclically switched back to "active" when the default setting is used (DO Restart Mode Parameter = "Automatic Restart after Failure").

In DO Restart Mode Parameter = "Restart after Output Reset", the output must be set to "inactive" via PLC, before the output can be set again to "active".

When an output channel is activated (rising edge of the channel state), the channel errors are filtered for the period that you set using the "Surveillance-Timeout" parameter during the configuration of the device. The value of this parameter can range from 0 to 255 ms; the factory setting is 80 ms.

The filter is used to avoid premature error messages when a capacitive load is activated.

The device sends the following PROFINET diagnostic message in the case of a fault:

Channel number of diagnostics	0x01 - 0x08
Channel related diagnostic code	0x1810
Channel related diagnostic code message	Short circuit at I/Q
Extended description	Short circuit on digital output at pin 2 / Ch.B of I/O port in DO mode. Check wire connection and also power supply

- ▶ The dedicated red port DIA indicator is active when an error is detected.



Attention: For variants 0980 XSL 3912-121-007D-00F and 0980 XSL 3912-121-007D-01F, the digital outputs of Channel B are **supplied by the U_L power**.

10.1.6 IO-Link C/Q error

If an IO-Link Device in COM mode is unplugged, an incorrect IO-Link Device is plugged in, or an electrical fault occurs (for example due to a short circuit), an error message is generated.

If parameter Pull Plug Alarms is enabled (default):

A pull sub-module alarm will be send to the PROFINET controller. A message text like the following will be visible in the controller diagnostic buffer: "Hardware component removed or missing".

- ▶ The dedicated green port IO-Link indicator is blinking when a device is missing.
- ▶ The dedicated red port DIA indicator is off when a device is missing.

If parameter Pull Plug Alarms is disabled & parameter Port Diagnostics is enabled:

The following diagnostic alarm will be sent to the PROFINET controller:

Channel number of diagnostics	0x01 - 0x08
Channel related diagnostic code	0x1800
Channel related diagnostic code message	No Device/communication lost

- ▶ The dedicated green port IO-Link indicator is blinking when a device is missing.
- ▶ The dedicated red port DIA indicator is off when a device is missing.

10.1.7 Generic parameter error

When an IO-Link Master parameter will be written to an invalid address (e.g. Sub-Slot / Index) or the parameter data content is detected as invalid for the IO-Link Master, the following IO-Link Master specific diagnostic messages will be generated:

Channel number of diagnostics	0x8000 (diagnostics not channel-specific)
Channel related diagnostic code	0x0010
Channel related diagnostic code message	Parameter error

10.1.8 I/O mapping parameter error

The individual I/O data mapping parameter of the Status/Control data will be checked by the IO-Link Master. When an error is detected inside this parameter block (e.g. a bit is mapped twice), the following message will be generated:

Channel number of diagnostics	0x8000 (diagnostics not channel-specific)
Channel related diagnostic code	0x011A
Channel related diagnostic code message	I/O mapping configuration faulty

10.1.9 Process data mismatch error

The IO-Link Master checks the configured IO-Link Sub-module data length with the detected IO-Link Device data length. In dependency of the parameter *Input Fraction*, the IO-Link Master generates the following diagnostic message in case of an error:

Channel number of diagnostics	0x8000 (diagnostics not channel-specific)
Channel related diagnostic code	0x17FF
Channel related diagnostic code message	Process Data mismatch

10.1.10 Force mode diagnostic

Forcing of the I/O data is possible via the Web interface for the following device variant:

- ▶ 0980 XSL 3912-121-007D-00F
- ▶ 0980 XSL 3912-121-007D-01F

In case of activated forcing, the following diagnostic message will be generated:

Channel number of diagnostics	0x8000 (diagnostics not channel-specific)
Channel related diagnostic code	0x000A
Channel related diagnostic code message	Simulation active

10.1.11 Internal module error

Internal module error states (e.g. internal abnormal states) will be reported by the following diagnostic message:

Channel number of diagnostics	0x8000 (diagnostics not channel-specific)
Channel related diagnostic code	0x0009
Channel related diagnostic code message	Error

10.2 Table of IO-Link Master diagnostic codes

The following table gives an overview of the defined diagnostic codes in PROFINET (0x0000 – 0x17FF) and IO-Link (0x1800 – 0xFFFF) specification. Not all listed codes are used.

Diagnostic code	Definition	Type
0x0000	Reserved	
0x0002	Undervoltage	Error
0x0009	Error	Error
0x000A	Simulation active	Error
0x0010	Parameter error	Error
0x0118	Low voltage of actuator power supply (UL). Check power supply	Error
0x011A	I/O mapping configuration faulty	Error
0x17FF	Process Data mismatch – check submodule configuration	Error
0x1800	No Device	Error
0x1801	Startup parametrization error - check parameter	Error
0x1802	Incorrect VendorID - Inspection Level mismatch	Error
0x1803	Incorrect DeviceID – Inspection Level mismatch	Error
0x1804	Short circuit at C/Q – check wire connection	Error
0x1805	PHY over temperature – Check master temperature and load	Error
0x1806	Short circuit at L+ - check wire connection	Error
0x1807	Overcurrent at L+ - check power supply (e.g. L1+)	Error
0x1808	Device Event overflow	Error
0x1809	Backup inconsistency - memory out of range	Error
0x180A	Backup inconsistency – identity fault	Error
0x180B	Backup inconsistency – parameter storage unspecific error	Error
0x180C	Backup inconsistency – upload fault	Error
0x180D	Parameter inconsistency – download fault	Error

Diagnostic code	Definition	Type
0x1810	Short circuit at I/Q – check wiring	Error
0x1811	Short circuit at C/Q (if digital output) – check wiring	Error
0x1812	Overcurrent at I/Q – check load	Error
0x1813	Overcurrent at C/Q (if digital output) – check load	Error
0x1814 to 0x1EFF	Reserved	
0x1F00 to 0x1FFF	Vendor specific	
0x2000 to 0x2FFF	Safety extensions	
0x3000 to 0x3FFF	Wireless extensions	
0x4000 to 0x5FFF	Reserved	
0x6000	Invalid cycle time	Error
0x6001	Revision fault	Error
0x6002	ISDU batch failed	Error
0x6003 to 0xFF20	Reserved	Error
0xFF21	Reserved	Notification
0xFF22	Reserved	Notification
0xFF23	Reserved	Notification
0xFF23	Reserved	Notification
0xFF24	Reserved	Notification
0xFF25	Reserved	Notification
0xFF26 ³	Port status changed	Notification
0xFF27 ²	Data Storage upload completed and new data object available	Notification
0xFF28 to 0xFF30	Reserved	
0xFF31	Reserved	Notification
0xFF32 to 0xFFFF	Reserved	Notification

³ For IO-Link Master internal use

10.3 IO-Link Device diagnostics in PROFINET

Diagnostics (Events) of the IO-Link Device which are sent to the IO-Link Master, are reported to the PROFINET controller via a standard channel diagnostic or an extended channel diagnostic.

Standard channel diagnostic message:

Channel number of diagnostics	0x01 - 0x08
Channel related diagnostic code	Depends on IO-Link Device diagnostics
Channel related diagnostic code message	Depends on IO-Link Device diagnostics

Extended channel diagnostic message:

Channel number of diagnostics	0x01 - 0x08
Ext. channel related diagnostic code	IO-Link Device event code

For IO-Link event codes in the range of 0x8000 - 0x7FFF, the MSB bit will be set to "0" in the PROFINET extended channel diagnostic code.

Event Code

Diagnostic code reported by the IO-Link Device. Use the IO-Link Device documentation to interpret the error message.

Channel Number

1 - 8 of the IO-Link Master port whose connected device is reporting an error.

10.4 Table of IO-Link Device diagnostic codes

The following table shows the defined diagnostic codes (events) of the IO-Link specification. Use the IO-Link Device documentation for vendor specific codes.

Diagnostic code	Definition	Type
0x0000	No malfunction	Notification
0x1000	General malfunction – unknown error	Error
0x1001 to 0x17FF	Reserved	
0x1800 to 0x18FF	Vendor specific	
0x1900 to 0x3FF	Reserved	
0x4000	Temperature fault – Overload	Error
0x4001 to 0x420F	Reserved	
0x4210	Device temperature overrun – Clear source of heat	Warning
0x4211 to 0x421F	Reserved	
0x4220	Device temperature underrun – Insulate Device	Warning
0x4221 to 0x4FFF	Reserved	
0x5000	Device hardware fault – Device exchange	Error
0x5001 to 0x500F	Reserved	
0x5010	Component malfunction – Repair or exchange	Error
0x5011	Non volatile memory loss – Check batteries	Error
0x5012	Batteries low – Exchange batteries	Warning
0x5013 to 0x50FF	Reserved	
0x5100	General power supply fault – Check availability	Error
0x5101	Fuse blown/open – Exchange fuse	Error
0x5102 to 0x510F	Reserved	
0x5013 to 0x50FF	Reserved	

Diagnostic code	Definition	Type
0x5100	General power supply fault – Check availability	Error
0x5101	Fuse blown/open – Exchange fuse	Error
0x5102 to 0x510F	Reserved	
0x5110	Primary supply voltage overrun – Check tolerance	Warning
0x5111	Primary supply voltage underrun – Check tolerance	Warning
0x5113 to 0x5FFF	Reserved	
0x6000		
0x6001 to 0x631F	Reserved	
0x6320	Parameter error – Check data sheet and values	Error
0x6321	Parameter missing – Check data sheet	Error
0x6322 to 0x634F	Reserved	
0x6350	Reserved	
0x6351 to 0x76FF	Reserved	
0x7700	Wire break of a subordinate device – Check installation	Error
0x7701 to 0x770F	Wire break of subordinate device 1 ...device 15 – Check installation	Error
0x7710	Short circuit – Check installation	Error
0x7711	Ground fault – Check installation	Error
0x7712 to 0x8BFF	Reserved	
0x8C00	Technology specific application fault – Reset Device	Error
0x8C01	Simulation active – Check operational mode	Warning
0x8C02 to 0x8C0F	Reserved	
0x8C10	Process variable range overrun – Process Data uncertain	Warning
0x8C11 to 0x8C1F	Reserved	
0x8C20	Measurement range exceeded – Check application	Error
0x8C21 to 0x8C2F	Reserved	
0x8C30	Process variable range underrun – Process Data uncertain	
0x8C31 to 0x8C3F	Reserved	
0x8C40	Maintenance required – Cleaning	Warning
0x8C41	Maintenance required – Refill	Warning

Diagnostic code	Definition	Type
0x8C42	Maintenance required – Exchange wear and tear parts	Warning
0x8C43 to 0x8C9F	Reserved	
0x8CA0 to 0x8DFF	Vendor specific	
0x8E00 to 0xAFFF	Reserved	
0xB000 to 0xB0FF	Reserved for Safety extensions	
0xB100 to 0xBFFF	Reserved for Profiles	
0xC000 to 0xFF90	Reserved	
0xFF91	Internal	Notification
0xFF92 to 0xFFAF	Reserved	
0xFFB0 to 0xFFB7	Reserved for Wireless extensions	
0xFFB8 to 0xFFFF	Reserved	

11 IloT functionality

The LioN-X variants offer a number of new interfaces and functions for the optimal integration into existing or future IloT (Industrial Internet of Things) networks. The devices continue to work as field bus devices which communicate with and are controlled by a PLC (Programmable Logic Controller).

In addition, the devices offer common IloT interfaces, which enable new communication channels besides the PLC. The communication is performed via IloT-relevant protocols MQTT and OPC UA. With the help of these interfaces not only all information in a LioN-X device can be read. They also enable its configuration and control, if the user wishes. All interfaces can be configured extensively and offer read-only functionality.

All LioN-X variants provide user administration, which is also applicable for accessing and configuring the IloT protocols. This allows you to manage all modification options for the device settings via personalized user authorizations.

All IloT protocols can be used and configured independently of the field bus. It is also possible to use the devices completely without the help of a PLC and control them via IloT protocols.



Attention: When using the IloT functionality, a protected local network environment without direct access to the Internet is recommended.

11.1 MQTT

MQTT functions are **only** applicable for the following LioN-X variants:

- ▶ 0980 XSL 3912-121-007D-00F
- ▶ 0980 XSL 3912-121-007D-01F

The MQTT (Message Queuing Telemetry Transport) protocol is an open network protocol for machine-to-machine communication, which provides the transmission of telemetric data messages between devices. The integrated MQTT client allows the device to publish a specific set of information to an MQTT broker.

The publishing of messages can either occur periodically or be triggered manually.

11.1.1 MQTT configuration

In **delivery state**, MQTT functions are **disabled**. The MQTT client can be configured either using the Web interface or directly via a JSON object sent in an HTTP request. For more information see chapter [MQTT configuration - Quick start guide](#) on page 169.

The configuration URL is:

```
http://[ip-address]/w/config/mqtt.json
```

The configuration can also read back as a JSON file:

```
http://[ip-address]/r/config/mqtt.json
```

The configuration is a JSON object. Each JSON member is a configuration element. The object must not contain all elements. Only the provided elements will be changed. The configuration changes apply only after a device restart.

The following configuration elements are available (default values in bold):

Element	Data type	Description	Example data
mqtt-enable	boolean	Master switch for the MQTT client.	true / false
broker	string	IP address of the MQTT Broker	" 192.168.1.1 "
login	string	Username for MQTT Broker	"admin" (Default: null)
password	string	Password for MQTT Broker	"private" (Default: null)
port	number	Broker port	1883
base-topic	string	Base topic	"iomodule_[mac]" (Default: " lionx ")
will-enable	boolean	If true, the device provides a last will message to the broker	true / false
will-topic	string	The topic for the last will message.	(Default: null)
auto-publish	boolean	If true, all enabled domains will be published automatically in the specified interval.	true / false
publish-interval	number	The publish interval in ms if auto-publish is enabled. Minimum is 250 ms.	2000
publish-identity	boolean	If true, all identity domain data will be published	true / false
publish-config	boolean	If true, all config domain data will be published	true / false
publish-status	boolean	If true, all status domain data will be published	true / false
publish-process	boolean	If true, all process domain data will be published	true / false
publish-devices	boolean	If true, all IO-Link Device domain data will be published	true / false
commands-allowed	boolean	Master switch for MQTT commands. If false, the device will not subscribe to any command topic, even if specific command topics are activated below.	true / false
force-allowed	boolean	If true, the device accepts force commands via MQTT.	true / false
reset-allowed	boolean	If true, the device accepts restart and factory reset commands via MQTT.	true / false
config-allowed	boolean	If true, the device accepts configuration changes via MQTT.	true / false

Element	Data type	Description	Example data
qos	number	Selects the "Quality of Service" status for all published messages.	0 = At most once 1 = At least once 2 = Exactly once

Table 36: MQTT configuration

MQTT response:

The resulting response is a JSON object with a "status" field. Status should be "0" if no error occurred and "-1" if there is an error.

In case of an error, the response contains an error array.

The error array contains an error object for each error occurred. The object consists of a field "Element" which names the config element which caused the error, and a field "Message" for the error message.

- ▶ A malformed JSON object produces an error.
- ▶ Not existing parameters produce an error.
- ▶ Parameters with a wrong data type produce an error.

It is not allowed to write all available parameters at once. You may write only one or a limited number of parameters.

Examples:

```
{ "status": -1, "error": [{"Element": "publish-interval", "Message": "Integer
expected"}]}

{"status": 0}

{"status": -1, "error": [{"Element": "root", "Message": "Not a JSON
object"}]}
```

For more information see chapter [MQTT topics](#) on page 157.

11.1.2 MQTT topics

MQTT mainly relates to topics. All messages are attached to a topic which adds context to the message itself. Topics may consist of any string and they are allowed to contain slashes (/) as well as wildcard symbols (*, #).

11.1.2.1 Base topic

For LioN-X and the LioN-Xlight variants there is a configurable Base topic which is the prefix for all topics. The Base topic can be chosen freely by the user. The Base topic can also contain selected variables as shown in [Table 37: Base topic variables](#) on page 157.

Variables in the Base topic have to be written in brackets ("[""). The following variables are possible:

Variable	Description
mac	The MAC address of the device
name	The name of the device
order	The ordering number of the device
serial	The serial number of the device

Table 37: Base topic variables

Example:

The Base topic "io_[mac]" translates to "io_A3B6F3F0F2F1".

All data is organized in domains. The domain name is the first level in the topic after the Base topic. Note the following notation:

Base-Topic/domain/....

There are the following domains:

Domain name	Definition	Example content
identity	All fixed data which is defined by the used hardware and which cannot be changed by configuration or at runtime.	Device name, ordering number, MAC address, port types, port capabilities and more.
config	Configuration data which is commonly loaded once at startup, mostly by a PLC.	IP address, port modes, input logic, failsafe values and more.
status	All (non-process) data which changes quite often in normal operation.	Bus state, diagnostic information, IO-Link Device status and data.
process	All process data which is produced and consumed by the device itself or by attached devices.	Digital inputs, digital outputs, cyclic IO-Link data.
iold	IO-Link Device parameters according to the IO-Link specification.	Vendor name, product name, serial number, hardware revision, software revision and more.

Table 38: Data domains

There is often one topic used for all gateway related information and topics for each port. All identity topics are published just once at start-up, because this information should never change. All other topics are published either in a fixed interval or just triggered manually, according to the configuration.

Topic	Content examples	Total publish count	Publish interval
[base-topic]/identity/gateway	Name, ordering number, MAC, vendor, I&M etc.	1	Startup
[base-topic]/identity/port/n	Port name, port type	8	Startup
[base-topic]/config/gateway	Configuration parameters, ip address etc.	1	Interval
[base-topic]/config/port/n	Port mode, data storage, mapping, direction	8	Interval
[base-topic]/status/gateway	Bus state, device diagnosis, master events	1	Interval
[base-topic]/status/port/n	Port or channel diagnosis, IO-Link state, IO-Link Device events	8	Interval
[base-topic]/process/gateway	All Digital IN/OUT	1	Interval
[base-topic]/process/port/n	Digital IN/OUT per port, IOL-data, pdValid	8	Interval
[base-topic]/iold/port/n	IO-Link Device parameter	8	Interval

Table 39: Data model

An MQTT client which wants to subscribe to one or more of these topics can also use wildcards.

Full topic	Description
[base-topic]/identity/gateway	Receive only identity objects for the gateway
[base-topic]/identity/#	Receive all data related to the identity domain
[base-topic]/status/port/5	Receive only status information for port number 5
[base-topic]/+/port/2	Receive information of all domains for port number 2
[base-topic]/process/port/#	Receive only process data for all ports
[base-topic]/config/#	Receive config data for the gateway and all ports.

Table 40: Use case examples

11.1.2.2 Publish topic

Overview of all publish JSON data for the defined topics:

Key	Data type
tbd	json_string
ordering_number	json_string
device_type	json_string
serial_number	json_string
mac_address	json_string
production_date	json_string
fw_name	json_string
fw_date	json_string
fw_version	json_string
hw_version	json_string
vendor_name	json_string
vendor_address	json_string
vendor_phone	json_string
vendor_email	json_string
vendor_techn_support	json_string
vendor_url	json_string
vendor_id	json_integer
device_id	json_integer

Table 41: Identity/gateway

Key	Data type	Range	Default value	Remarks
fieldbus_protocol	json_string	profinet, ethernet/ip, ethercat		
network_configuration	json_string	PN: dcp EIP: stored_value, bootp, dhcp		
rotary_switches	json_integer	0..999		
ip_address	json_string		192.168.1.1	
subnet_mask	json_string		255.255.255.0	
report_alarms	json_boolean		0.0.0.0	
report_ul_alarm	json_boolean	true / false	true	
report_do_fault_without_ul	json_boolean	true / false	false	
force_mode_lock	json_boolean	true / false	false	
web_interface_lock	json_boolean	true / false	false	
do_auto_restart	json_boolean	true / false	true	
fast_startup	json_boolean	true / false	false	PROFINET and EIP only

Table 42: Config/gateway

Key	Data type	Range	Default value	Remarks
protocol	json_string	wait_for_io_system wait_for_io_Connection failsafe connected error		
ethernet_port1	json_string	100_mbit/s_full 100_mbit/s 10_mbit/s_full 100_mbit/s		
ethernet_port2	json_string	100_mbit/s_full 100_mbit/s 10_mbit/s_full 100_mbit/s		
module_restarts	json_integer	0..4294967295		
channel_diagnosis	json_boolean	true / false		
failsafe_active	json_boolean	true / false		
system_voltage_fault	json_boolean	true / false		
actuator_voltage_fault	json_boolean	true / false		
internal_module_error	json_boolean	true / false		
forcemode_enabled	json_boolean	true / false		

Table 43: Status/gateway

Key	Data type	Range	Default value	Remarks
Input_data	json_integer[]			
output_data	json_integer[]			

Table 44: Process/gateway

Key	Data type	Range	Default value	Remarks
port	json_integer	1..8		
type	json_string	digital_universal digital_input digital_Output io_link		
max_output_power_cha	json_string	2.0_mA 0.5_mA		
max_output_power_chb	json_string	2.0_mA 0.5_mA		
channel_cha	json_string	input/output input output io_link aux		
channel_chb	json_string	input/output input output io_link aux		

Table 45: Identity/port/1 ... 8

Key	Data type	Range	Default value	Remarks
port	json_integer	1..8		
direction_cha	json_string	input/output input output		
direction_chb	json_string	input/output input output		
failsafe_cha	json_string	set_low set_high hold_last	set_low	
failsafe_chb	json_string	set_low set_high hold_last	set_low	
surveillance_timeout_cha	json_integer	0..255	80	
surveillance_timeout_chb	json_integer	0..255	80	

Table 46: Config/port/1 ... 8

Key	Data type	Range	Default value	Remarks
port	json_integer	1..8		
physical_state_cha	json_integer	0..1		
physical_state_chb	json_integer	0..1		
actuator_short_circuit_cha	json_boolean	true / false		
actuator_short_circuit_chb	json_boolean	true / false		
sensor_short_circuit	json_boolean	true / false		

Table 47: Status/port/1 ... 8

11.1.2.3 Command topic (MQTT Subscribe)

The main purpose of MQTT is to publish data from the device to a broker. This data can then be received by any subscriber who is interested in this data. But also the other way round is possible. The device can subscribe to a topic on the broker and is then able to receive data. This data can contain configuration or forcing data. This allows the user to fully control a device via MQTT only, without using other ways of communication like Web or REST.

If the configuration allows commands in general, the device subscribes to special Command topics on which it can receive commands from other MQTT clients. The Command topic is based upon the Base topic. It always has the following form:

```
[base-topic]/command
```

After the Command topic, there are fixed topics for different writeable objects. The data format of the MQTT payload is always JSON. It is possible to set only a subset of the possible objects and fields.

[...]/forcing

Use the Command topic `[base-topic]/command/forcing` for *Force object* data. The *Force object* can contain any of the following properties:

Property	Data type	Example values	Remarks
forcemode	boolean	true / false	Forcing Authority: on/off
digital	array (Table 49: Force object: Digital on page 166)		
iol	array (Table 50: Force object: IOL (IO-Link devices only) on page 166)		

Table 48: Force object properties

For the *Force object* properties `digital` and `iol`, there are several value specifications arrayed:

Property	Data type	Example values	Remarks
port	integer	1, 2, 5	
channel	string	"a", "b"	
force_dir	string	"out", "in", "clear"	
force_value	integer	0, 1	

Table 49: Force object: Digital

Property	Data type	Example values	Remarks
port	integer	0, 1, 5	
output	array[integer]	[55, 88, 120]	
input	array[integer]		Input-Simulation

Table 50: Force object: IOL (IO-Link devices only)

[...]/config

Use the Command topic `[base-topic]/command/config` for *Config object* data. The *Config object* can contain any of the following properties:

Property	Data type	Example values	Remarks
portmode	array (Table 52: Config object: Portmode on page 167)		
ip_address	string	"192.168.1.5"	
subnet_mask	string	"255.255.255.0"	
gateway	string	"192.168.1.100"	

Table 51: Config object properties

For the *Conig object* property `portmode`, there are several value specifications arrayed:

Property	Data type	Example values	Remarks
<code>port</code>	integer	2	
<code>channelA*</code>	string	"dio", "di", "do", "iol", "off"	
<code>channelB*</code>	string	"dio", "di", "do", "iol", "off", "aux"	
<code>inlogicA</code>	string	"no", "nc"	
<code>inlogicB</code>	string	"no", "nc"	
<code>filterA</code>	integer	3	input filter in ms
<code>filterB</code>	integer	3	input filter in ms
<code>autorestartA</code>	boolean		
<code>autorestartB</code>	boolean		
<code>ioValidation</code>	integer	0 = NoCheck 1 = Type 1.0 2 = Type 1.1 3 = Type 1.1 BR 4 = Type 1.1 RES	
<code>ioDeviceID</code>	integer		for validation
<code>ioVendorID</code>	integer		for validation

Table 52: Config object: Portmode

*`channelA` = Pin 4, `channelB` = Pin 2

[...]/reset

Use the Command topic `[base-topic]/command/reset` for *Reset object* data about restart and factory reset issues. The *Reset object* can contain any of the following properties:

Property	Data type	Example values	Remarks
factory_reset	boolean	true / false	
system_reset	boolean	true / false	

Table 53: Reset object properties

[...]/publish

Use the Command topic `[base-topic]/command/publish` for *Publish object* data.

Trigger publish of all topics manually (can be used when auto publish is off or long interval is set).

11.1.3 MQTT configuration - Quick start guide



Attention: Lumberg Automation™ is not responsible for any content of the referenced Web pages and provides no warranty for any functionality of the named third party software.

11.1.3.1 MQTT configuration via JSON

1. Depending on your application case, download and install *Insomnia* or a comparable application: <https://insomnia.rest/download/>

2. Configure MQTT:

POST: [IP-address]/w/config/mqtt.json

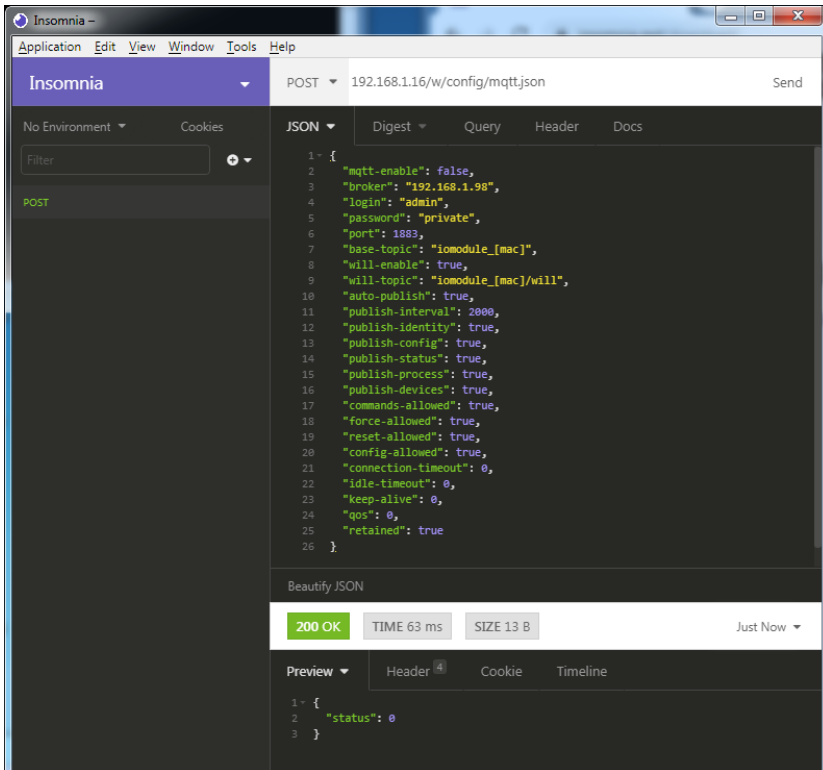

3. Read MQTT:

GET: [IP-address]/r/config/mqtt.json

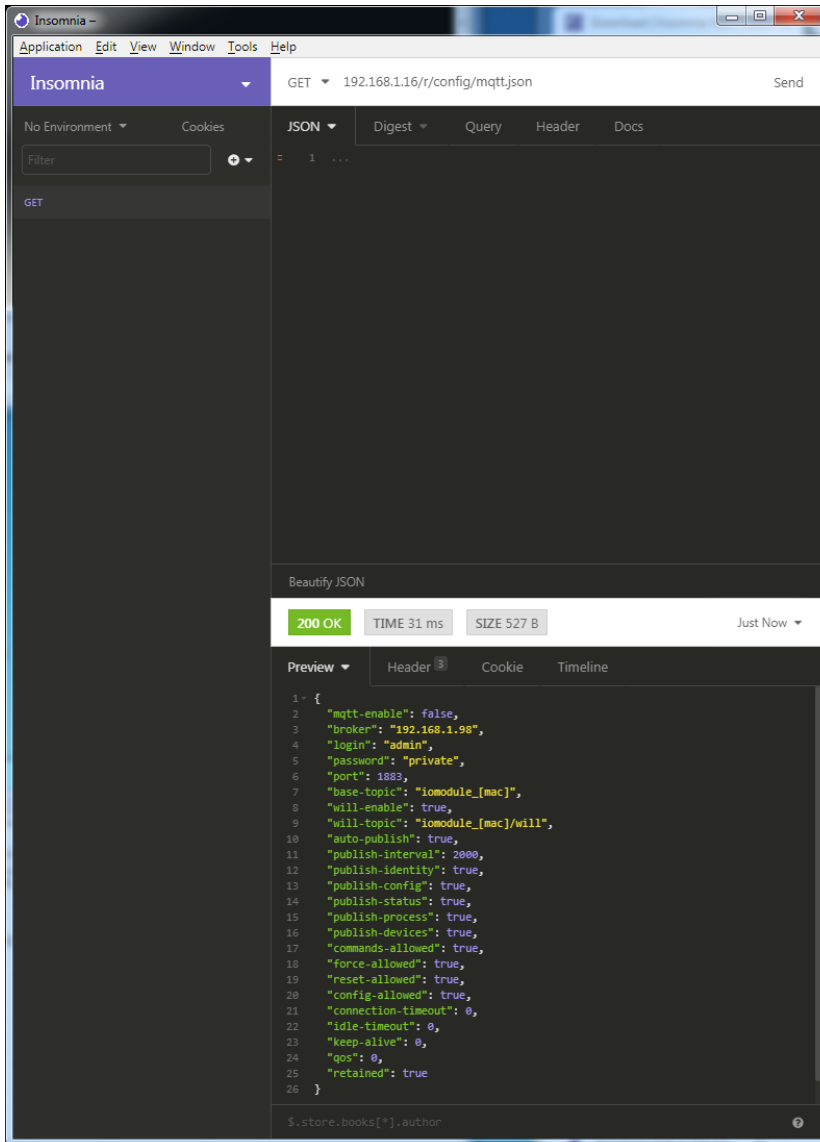

11.2 OPC UA

OPC UA functions are **only** applicable for the following LioN-X variants:

- ▶ 0980 XSL 3912-121-007D-00F
- ▶ 0980 XSL 3912-121-007D-01F

OPC Unified Architecture (OPC UA) is a platform-independent standard with a service-oriented architecture for communication in and with industrial automation systems.

The OPC UA standard is based on the client-server principle and lets machines and devices, regardless of any preferred field bus, communicate horizontally among each other as well as vertically to the ERP system or the cloud. LioN-X provides an OPC UA server on field device level, with which an OPC UA client can connect for information exchange secure in transmission.

For OPC UA, we comply (apart from the exceptions listed [below](#)) with the IO-Link Companion Specification, which can be downloaded from catalog.belden.com or directly from io-link.com.

Feature	Support
Managing IODDs (chapter 6.1.6 in the specification)	Not supported
Mapping IODD information to OPC UA ObjectTypes (chapter 6.3 in the specification)	Not supported
IOLinkIODDDeviceType (chapters 7.2 ff. in the specification)	Not supported
ObjectTypes generated based on IODDs (chapters 7.3 ff. in the specification)	Not supported
Creation of Instances based on ObjectTypes generated out of IODDs (chapter 7.4 in the specification)	Not supported
IODDManagement Object (chapter 8.2 in the specification)	Not supported
RemoveIODD Method (chapter 8.3 in the specification)	Not supported

Table 54: Non-supported OPC UA features according to the IO-Link Companion Specification

11.2.1 OPC UA configuration

In **delivery state**, OPC UA functions are **disabled**. The OPC UA Server can be configured either using the Web interface or directly via a JSON Object sent in an HTTP request. For more information see [OPC UA configuration - Quick start guide](#) on page 175.

The configuration URL is:

```
http://[ip-address]/w/config/opcu.json
```

The configuration can also read back as a JSON file:

```
http://[ip-address]/r/config/opcu.json
```

The configuration is a JSON object. Each JSON member is a configuration element. The object must not contain all elements. Only the provided elements will be changed. All configuration changed applies only after a device restart.

There are the following configuration elements (default values in bold):

Element	Data type	Description	Example data
port	integer	Server port for the OPC UA server.	0, 4840 , 0xFFFF
opcua-enable	boolean	Master switch for the OPC UA server.	true / false
anon-allowed	boolean	If true, anonymous login is allowed.	true / false
commands-allowed	boolean	Master switch for OPC UA commands. If false there will be no writeable OPC UA objects.	true / false
force-allowed	boolean	If true, the device accepts force commands via OPC UA.	true / false
reset-allowed	boolean	If true, the device accepts restart and factory reset commands via OPC UA.	true / false
config-allowed	boolean	If true, the device accepts configuration changes via OPC UA.	true / false

Table 55: OPC UA Configuration

All configuration elements are optional and do not need a specific order. Not every element is required to be sent. This means that only configuration changes will be taken over.

Optional: The configuration parameters of OPC UA can be set directly via the Web interface. It is possible to download the Web interface for sharing with other devices.

Response:

The resulting response is a JSON object with a "status" field. Status should be 0 if no error occurred and -1 if there is an error.

In case of an error, the response contains an error array.

The error array contains an error object for each error occurred. The object consists of a field "Element" which names the config element which caused the error, and a field "Message" for the error message.

Examples:

```
{"status": -1, "error": [{"Element": "upcua-enable", "Message": "Boolean expected"}]}  
  
{"status": 0}  
  
{"status": -1, "error": [{"Element": "root", "Message": "Not a JSON object"}]}
```

11.2.2 OPC UA address space

OPC UA provides different services on the Lion-X devices with which a client can navigate through the hierarchy of the address space and read or write variables. In addition, the client can monitor up to 10 attributes from the address space for value changes.

A connection to an OPC UA server is established via the endpoint URL:

```
opc.tcp://[ip-address]:[port]
```

Various device data such as MAC address, device settings, diagnostics or status information can be read via *Identity objects*, *Config objects*, *Status objects* and *Process objects*.

Command objects can be read and written. This makes it possible, for example, to transfer new network parameters to the device, to use Force Mode or to reset the entire device to its factory settings.

The following figures illustrate the OPC UA address space of the Lion-X devices. The objects and information displayed depend on the device variant used.

11.2.3 OPC UA configuration - Quick start guide

i **Attention:** Lumberg Automation™ is not responsible for any content of the referenced Web pages and provides no warranty for any functionality of the named third party software.

11.2.3.1 OPC UA configuration via JSON

1. Depending on your application case, download and install *Insomnia* or a comparable application: <https://insomnia.rest/download/>

2. Configure OPC UA:

POST: [IP-address] /w/config/opcu.json

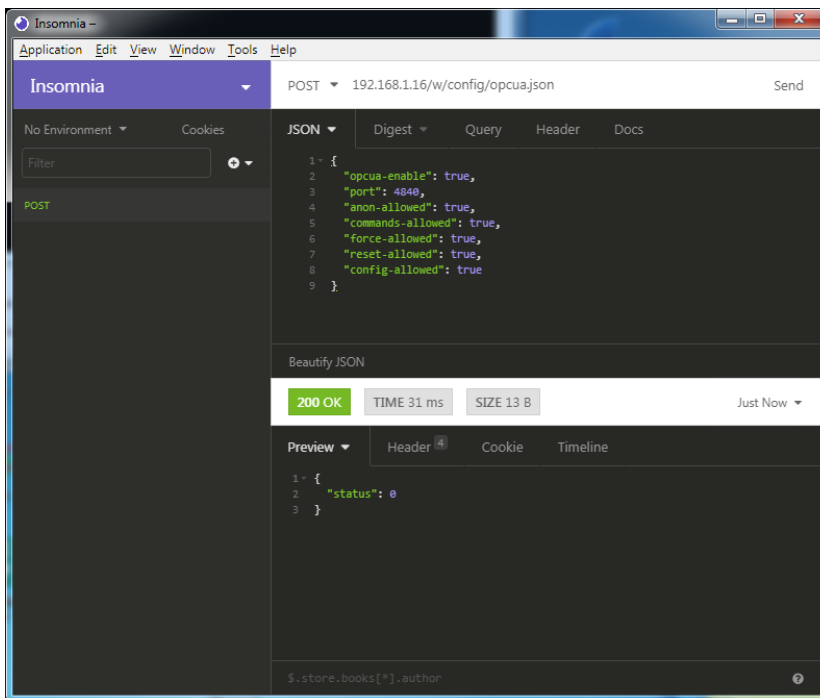

3. Read OPC UA:

GET: [IP-address]/r/config/opcuajson

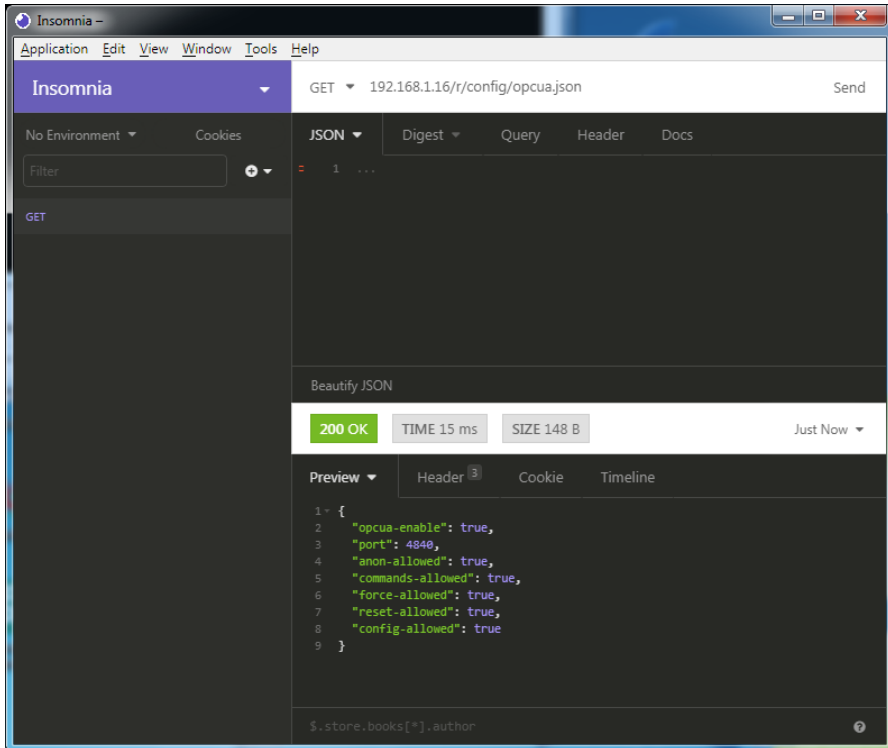

11.3 REST API

The Representational State Transfer – Application Programming Interface (REST API) is a programmable interface which uses HTTP requests to GET and POST data. This enables the access to detailed device information.

For LioN-X and the LioN-Xlight variants, the REST API can be used to read the device status. For the LioN-X multiprotocol variants, the REST API can also be used to write configuration and forcing data.

There are two different REST API standards you can use for the requests:

1. A standardized REST API that has been specified by the IO-Link Community and is described separately:

JSON_Integration_10222_V100_Mar20.pdf

Please download the file from catalog.belden.com or directly from io-link.com.



Attention: Consider the following table to get an overview of the supported features of the IO-Link specification:

Feature		Supported
Gateway	GET /identification	Yes
	GET /capabilities	Yes
	GET /configuration	Yes
	POST /configuration	Yes
	POST /reset	Yes
	POST /reboot	Yes
	GET /events	Yes
Master	GET /masters	Yes
	GET /capabilities	Yes
	GET /identification	Yes
	POST /identification	Yes

Feature		Supported
Port	GET /ports	Yes
	GET /capabilities	Yes
	GET /status	Yes
	GET /configuration	Yes
	POST /configuration	Yes
	GET /datastorage	Not supported
	POST /datastorage	Not supported
Devices	GET /devices	Yes
	GET /capabilities	Yes
	GET /identification	Yes
	POST /identification	Yes
	GET /processdata/value	Yes
	GET /processdata/getdata/value	Yes
	GET /processdata/setdata/value	Yes
	POST /processdata/value	Yes
	GET /parameters	Yes
	GET /parameters/{index}/subindices	Yes
	GET /parameters/{parameterName}/subindices	Not supported
	GET /parameters/{index}/value	Yes
	GET /parameters/{index}/subindices/{subindex}/value	Yes
	GET /parameters/{parameterName}/value	Not supported
	GET /parameters/{parameterName}/subindices/{subParameterName}/value	Not supported
	POST /parameters/{index}/value	Yes
	POST /parameters/{parameterName}/value	Not supported
	POST /parameters/{index}/subindices/{subindex}/value	Yes
	POST /parameters/{parameterName}/subindices/{subParameterName}/value	Not supported
	POST /blockparametrization	Not supported
	GET /events	Yes

Feature		Supported
IODD	GET /iodds	Not supported
	POST /iodds/file	Not supported
	DELETE /iodds	Not supported
	GET /iodds/file	Not supported

Table 56: Support of REST API features according to the IO-Link specification

2. A customized Belden REST API that is described in the following chapters.

11.3.1 Standard device information

Request method:	http GET
Request URL:	<ip>/info.json
Parameters	n.a.
Response format	JSON

The goal of the "Standard device information" request is to get a complete snapshot of the current device status. The format is JSON. For IO-Link devices, all ports with connected IO-Link device information are included.

11.3.2 Structure

Name	Data type	Description	Example
name	string	Device name	"0980 XSL 3912-121-007D-00F"
order-id	string	Ordering number	"935 700 001"
fw-version	string	Firmware version	"V.1.1.0.0 - 01.01.2021"
hw-version	string	Hardware version	"V.1.00"
mac	string	MAC address of the device	"3C B9 A6 F3 F6 05"
bus	number	0 = No connection 1 = Connection with PLC	1
failsafe	number	0 = Normal operation 1 = Outputs are in failsafe	0
ip	string	IP address of the device	
snMask	string	Subnet Mask	
gw	string	Default gateway	
rotarys	array of numbers (3)	Current position of the rotary switches: Array element 0 = x1 Array element 1 = x10 Array element 2 = x100	
ulPresent	boolean	True, if there is a UL voltage supply detected within valid range	
usVoltage_mv	number	US voltage supply in mV	
ulVoltage_mv	number	UL voltage supply in mV (only available for devices with UL supply)	
inputs	array of numbers (2)	Real state of digital inputs. Element 0 = 1 Byte: Port X1 Channel A to Port X4 Channel B Element 0 = 1 Byte: Port X5 Channel A to Port X8 Channel B	\[128,3]
output	array of numbers (2)	Real State of digital outputs. Element 0 =1 Byte: Port X1 Channel A to port X4 Channel B Element 0 = 1 Byte: Port X5 Channel A to port X8 Channel B	\[55,8]

Name	Data type	Description	Example				
consuming	array of numbers (2)	Cyclic data from PLC to device					
producing	array of numbers (2)	Cyclic data from device to PLC					
diag	array of numbers (4)	Diagnostic information <table border="1" style="margin-left: 20px;"> <tr> <td> Element 0 = 1 Byte: Bit 7: Internal module error (IME) Bit 6: Forcemode active Bit 3: Actuator short Bit 2: Sensor short Bit 1: U_L fault Bit 0: U_S fault </td> </tr> <tr> <td> Element 1 = 1 Byte: Sensor short circuit ports X1 .. X8. </td> </tr> <tr> <td> Element 2 = 1 Byte: Actuator short circuit ports X1 Channel A to X4 Channel B </td> </tr> <tr> <td> Element 3 = 1 Byte: Actuator short circuit ports X5 Channel A to X8 Channel B </td> </tr> </table>	Element 0 = 1 Byte: Bit 7: Internal module error (IME) Bit 6: Forcemode active Bit 3: Actuator short Bit 2: Sensor short Bit 1: U _L fault Bit 0: U _S fault	Element 1 = 1 Byte: Sensor short circuit ports X1 .. X8.	Element 2 = 1 Byte: Actuator short circuit ports X1 Channel A to X4 Channel B	Element 3 = 1 Byte: Actuator short circuit ports X5 Channel A to X8 Channel B	
Element 0 = 1 Byte: Bit 7: Internal module error (IME) Bit 6: Forcemode active Bit 3: Actuator short Bit 2: Sensor short Bit 1: U _L fault Bit 0: U _S fault							
Element 1 = 1 Byte: Sensor short circuit ports X1 .. X8.							
Element 2 = 1 Byte: Actuator short circuit ports X1 Channel A to X4 Channel B							
Element 3 = 1 Byte: Actuator short circuit ports X5 Channel A to X8 Channel B							
fieldbus	FIELDBUS Object						
FIELDBUS Object							
fieldbus_name	string	Currently used fieldbus					
state	number	Fieldbus state					
state_text	number	Textual representation of fieldbus state: 0 = Unknown 1 = Bus disconnected 2 = Preop 3 = Connected 4 = Error 5 = Stateless					
forcing	FORCING Object	Information about the forcing state of the device					
channels	Array of CHANNEL (16)	Basic information about all input/output channels					

Name	Data type	Description	Example
iol	IOL Object	Contains all IO-Link related information such as events, port states, device parameters.	
iol/diagGateway	array of DIAG	Array of currently active device/gateway related events	
iol/diagMaster	array of DIAG	Array of currently active IOL-Master related events	
iol/ports	array of PORT (8)	Contains one element for each IO-Link port	
CHANNEL Object			
name	string	Name of channel	
type	number	Hardware channel type as number: 0 = DIO 1 = Input 2 = Output 3 = Input/Output 4 = IO-Link 5 = IOL AUX 6 = IOL AUX with DO 7 = IOL AUX with DO. Can be deactivated. 8 = Channel not available	
type_text	string	Textual representation of the channel type	
config	number	Current configuration of the channel: 0 = DIO 1 = Input 2 = Output 3 = IO-Link 4 = Deactivated 5 = IOL AUX	
config_text	string	Textual representation of the current config	
inputState	boolean	Input data (producing data) bit to the PLC	
outputState	boolean	Output data bit to the physical output pin	

Name	Data type	Description	Example
forced	boolean	True, if the output pin of this channel is forced	
simulated	boolean	True, if the input value to the PLC of this channel is simulated	
actuatorDiag	boolean	True, if the output is in short circuit / overload condition	
sensorDiag	boolean	True, if the sensor supply (Pin 1) is in short circuit / overload condition	
maxOutputCurrent_mA	number	Maximum output current of the output in mA	
current_mA	number	Measured current of the output in mA (if current measurement is available)	
voltage_mV	number	Measured voltage of this output in mV (if voltage measurement is available)	
PORT Object			
port_type	string	Textual representation of the IO-Link port type	
iolink_mode	number	Current port mode: 0 = Inactive 1 = Digital output 2 = Digital input 3 = SIO 4 = IO-Link	
iolink_text	string	Textual representation of the current port mode	"Digital Input"
aux_mode	number	Indicates the configured mode for the Pin 2: 0 = No AUX 1 = AUX output (always on) 2 = Digital output (can be controlled by cyclic data) 3 = Digital input	
aux_text	string	Textual representation of the current aux mode	"AUX Output"
cq_mode	number	Port mode according to IOL specification	
iq_mode	number	Pin2 mode according to IOL specification	

Name	Data type	Description	Example
port_status	number	Port status according to IOL specification	
ds_fault	number	Data storage error number	
ds_fault_text	string	Textual data storage error.	
device	DEVICE Object	IO-Link device parameters. → Null if no IO-Link communication active	
diag	array of DIAG (n)	Array of port related events	
DIAG Object			
error	number	Error code	
source	string	Source of the current error.	"device" "master"
eventcode	number	Event code according to IO-Link specification	
eventqualifier	number	Event qualifier according to IO-Link specification	
message	string	Error message	"Supply Voltage fault"
DEVICE Object		Standard parameters of the IOL-Device	
device_id	number		
vendor_id	number		
serial	string		
baudrate	string	Baudrate (COM1,2,3)	
cycle_time	number	Cycle time in microseconds	
input_len	array of numbers (n)	IOL input length in bytes	
output_len	array of numbers (n)	IOL output length in bytes	
input_data	array of numbers (n)	IOL input data	
output_data	array of numbers (n)	IOL output data	
pd_valid	number	"1", if IOL input data is valid	
pdout_valid	number	"1", if IOL output data is valid	
FORCING Object		Forcing information of the device	
forcingActive	boolean	Force mode is currently active	

Name	Data type	Description	Example
forcingPossible	boolean	True, if forcing is possible and force mode can be activated	
ownForcing	boolean	True, if forcing is performed by REST API at the moment	
forcingClient	string	Current forcing client identifier	
digitalOutForced	array of numbers (2)	The force values of all 16 digital output channels.	
digitalOutMask	array of numbers (2)	The forcing mask of all 16 digital output channels.	
digitalInForced	array of numbers (2)	The force values of all 16 digital input channels.	
digitalInMask	array of numbers (2)	The forcing mask of all 16 digital input channels.	

11.3.3 Configuration and forcing

Method:	POST
URL:	<ip>/w/force.json
Parameters:	None
Post-Body:	JSON Object

Property	Data type	Example values	Description
forcemode	boolean	true / false	Forcing authority on/off
portmode	array (Port mode object)		
digital	array (Digital object)		
iol	array (IOL object)		

Table 57: Root object

Property	Data type	Example values	Remarks
port	integer	0..7	
channel	integer	"a","b"	optional default is "a"
direction	string	"dio","di","do","iol", "off", "aux"	
aux	string	"dio","di","do","iol", "off", "aux"	IOL only, but optional
inlogica	string	"no","nc"	
inlogicb	string	"no","nc"	

Table 58: Port mode object

Property	Data type	Example values	Remarks
port	integer	0..7	
channel	string	"a","b"	
force_dir	string	"phys_out","plc_in","clear"	optional default is "phys_out"
force_value	integer	0,1	

Table 59: Digital object

Property	Data type	Example values	Remarks
port	integer	0..7	
output	array[integer] or null to clear forcing	[55,88,120]	Output forcing
input	array[integer] or null to clear forcing	[20,0,88]	Input simulation to PLC

Table 60: IOL object

11.3.4 Reading and writing ISDU parameters

The *Indexed Service Data Unit* (ISDU) provides a highly flexible message format, which can contain single or multiple commands.

LioN-X IOL-Masters with IIoT support reading and writing ISDU parameters from connected IOL-Devices. It is possible to do this as a bulk transfer by reading and writing of multiple ISDU parameters via a single request.

11.3.4.1 Reading ISDU

Method:	POST
URL:	<ip>/r/isdu.json
Parameters:	port (0-7)
Example:	<code>192.168.1.20/r/isdu.json?port=5</code>
Post-Body:	JSON array of read ISDU object

Property	Data type	Example values	Remarks
ix	integer	0-INT16	Index to be read
subix	integer	0-INT8	Subindex to be read

Table 61: Read ISDU object

Property	Data type	Example values	Remarks
status	integer	0, -1	0 = no error, -1= an error occurred
message	string		Error Message if error occurred
data	array (Read ISDU data object)		data, if no error occurred. otherwise null

Table 62: Read ISDU response object

Property	Data type	Example values	Remarks
ix	integer	0-INT16	Index that was read
subix	integer	0-INT8	Subindex that was read
status	integer	0, -1	0 = no error, -1= an error occurred
eventcode	integer		IOL eventcode if status is -1
data	array[integer]		data, if no error occurred. otherwise null

Table 63: Read ISDU data object

11.3.4.2 Writing ISDU

Method:	POST
URL:	<ip>/w/isdu.json
Parameters:	port (0-7)
Post-Body:	JSON array of write ISDU object

Property	Data type	Example values	Remarks
ix	integer	0-INT16	Index to be read
subix	integer	0-INT8	Subindex to be read
data	array[integer]		Data to be written

Table 64: Write ISDU object

Response: Write ISDU response object

Property	Data type	Example values	Remarks
status	integer	0, -1	0 = no error, -1= an error occurred
message	string		Error Message if error occurred
data	array (Write ISDU data object)		data, if no error occurred. otherwise null

Table 65: Write ISDU response object

Property	Data type	Example values	Remarks
ix	integer	0-INT16	Index that was written
subix	integer	0-INT8	Subindex that was written
status	integer	0, -1	0 = no error, -1= an error occurred
eventcode	integer		IOL eventcode if status is -1

Table 66: Write ISDU data object

11.3.5 Example: Reading ISDU

ISDU read request

```
[
  {
    "ix":5,"subix":0},
  {
    "ix":18,"subix":0},
  {
    "ix":19,"subix":0},
  {
    "ix":20,"subix":0}
]
```

Response

```
{
  "message": "OK",
  "data":
  [
    {
      "ix":5,"subix":0,"status":-1,"eventcode":32785},
    {
      "ix":18,"subix":0,"data":[79,68,83,49,48,76,49,46,56,47,76,65,54,44,50,
        48,48,45,77,49,50],"status":0},
    {
      "ix":19,"subix":0,"data":[53,48,49,50,57,53,51,53],"status":0},
    {
      "ix":20,"subix":0,"data":[100,105,115,116,97,110,99,101,32,115,101,110,
        115,111,114],"status":0}
  ],
  "status":0}
}
```

11.3.6 Example: Writing ISDU

ISDU write request

```
[
  {
    "ix":24,"subix":0,"data":[97,98,99,100,101,102]},
  {
    "ix":9,"subix":0,"data":[97,97,97,97,97,98]}
]
```

Response

```
{
  "message": "OK",
  "data": [
    {
      "ix":24,"subix":0,"status":0},
    {
      "ix":9,"subix":0,"eventcode":32785,"status":-1}
  ],
  "status":0}
}
```

11.4 CoAP server

The CoAP server functions are **only** applicable for the following LioN-X variants:

- ▶ 0980 XSL 3912-121-007D-00F
- ▶ 0980 XSL 3912-121-007D-01F

The **Constrained Application Protocol (CoAP)** is a specialized Internet application protocol for constrained networks such as lossy or low power networks. CoAP is useful especially in M2M (Machine to Machine) communication and can be used to translate simplified HTTP requests of low speed networks.

CoAP is based on the Server-Client principle and a service layer protocol that lets nodes and machines communicate with each other. The LioN-X multiprotocol variants provide CoAP server functionalities via a REST API interface over UDP.

11.4.1 CoAP configuration

In **delivery state**, CoAP functions are **disabled**. The CoAP server can be configured either using the Web interface or directly via a JSON object sent in an HTTP request. For more information see chapter [CoAP configuration - Quick start guide](#) on page 197.

The configuration URL is:

```
http://[ip-address]/w/config/coapd.json
```

The configuration can also read back as a JSON file:

```
http://[ip-address]/r/config/coapd.json
```

The configuration is a JSON object. Each JSON member is a configuration element. The object must not contain all elements. Only the provided elements will be changed. The configuration changes apply only after a device restart.

The following configuration elements are available (default values in bold):

Element	Data type	Description	Example data
enable	boolean	Master switch for the CoAP server	true / false
port	integer (0 to 65535)	Port of the CoAP server	5683

Table 67: CoAP configuration

CoAP response:

The resulting response is a JSON object with a "status" field. Status should be "0" if no error occurred, and "-1" if there is an error.

In case of an error, the response contains an error array.

The error array contains an error object for each error occurred. The object consists of a field "Element" which names the config element that caused the error, and of a field "Message" for the error message.

Examples:

```
{ "status": -1, "error": [{"Element": "upcua-enable", "Message": "Boolean
expected"}]}

{ "status": 0 }

{ "status": -1, "error": [{"Element": "root", "Message": "Not a JSON
object"}]}
```

11.4.2 REST API access via CoAP

A connection to the CoAP server running on the LioN-X multiprotocol variants can be established via the following URL:

```
coap://[ip-address]:[port]/[api]
```

For LioN-X, the following REST API Requests (JSON format) can be accessed via a CoAP endpoint:

Type	API	Note
GET	/r/status.lr	
GET	/r/system.lr	
GET	/info.json"	
GET	/r/config/net.json	
GET	/r/config/mqtt.json	
GET	/r/config/opcu.json	
GET	/r/config/coapd.json	
GET	/r/config/syslog.json	
GET	/contact.json	
GET	/fwup_status	
GET	/iolink/v1/gateway/identification	
GET	/iolink/v1/gateway/capabilities	
GET	/iolink/v1/gateway/configuration	
GET	/iolink/v1/gateway/events	
GET	/iolink/v1/masters	
GET	/iolink/v1/masters/1/capabilities	
GET	/iolink/v1/masters/1/identification	
GET	/iolink/v1/masters/1/ports	
GET	/iolink/v1/masters/1/ports/{port_number}/capabilities	This API is available for all 8 ports. {port_number} should be between "1" and "8".
GET	/iolink/v1/masters/1/ports/{port_number}/status	This API is available for all 8 ports. {port_number} should be between "1" and "8".
GET	/iolink/v1/masters/1/ports/{port_number}/configuration	This API is available for all 8 ports. {port_number} should be between "1" and "8".
GET	/iolink/v1/devices/master1port{port_number}/identification	This API is available for all 8 ports. {port_number} should be between "1" and "8".

Type	API	Note
GET	/iolink/v1/devices/master1port{port_number}/capabilities	This API is available for all 8 ports. {port_number} should be between "1" and "8".
GET	/iolink/v1/devices/master1port{port_number}/processdata/getdata/value	This API is available for all 8 ports. {port_number} should be between "1" and "8".
GET	/iolink/v1/devices/master1port{port_number}/events	This API is available for all 8 ports. {port_number} should be between "1" and "8".

Table 68: REST API access via CoAP

11.4.3 CoAP configuration - Quick start guide



Attention: Lumberg Automation™ is not responsible for any content of the referenced Web pages and provides no warranty for any functionality of the named third party software.

11.4.3.1 CoAP configuration via JSON

1. Depending on your application case, download and install *Insomnia* or a comparable application: <https://insomnia.rest/download/>

2. Configure CoAP:

POST: [IP-address] /w/config/coapd.json

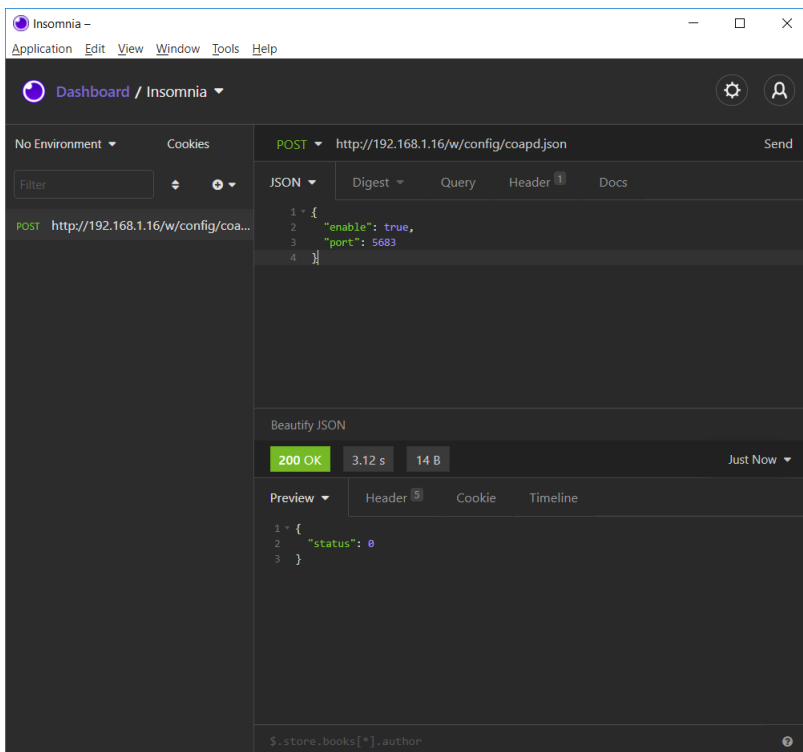

3. Read CoAP configuration:

GET: [IP-address]/r/config/coapd.json

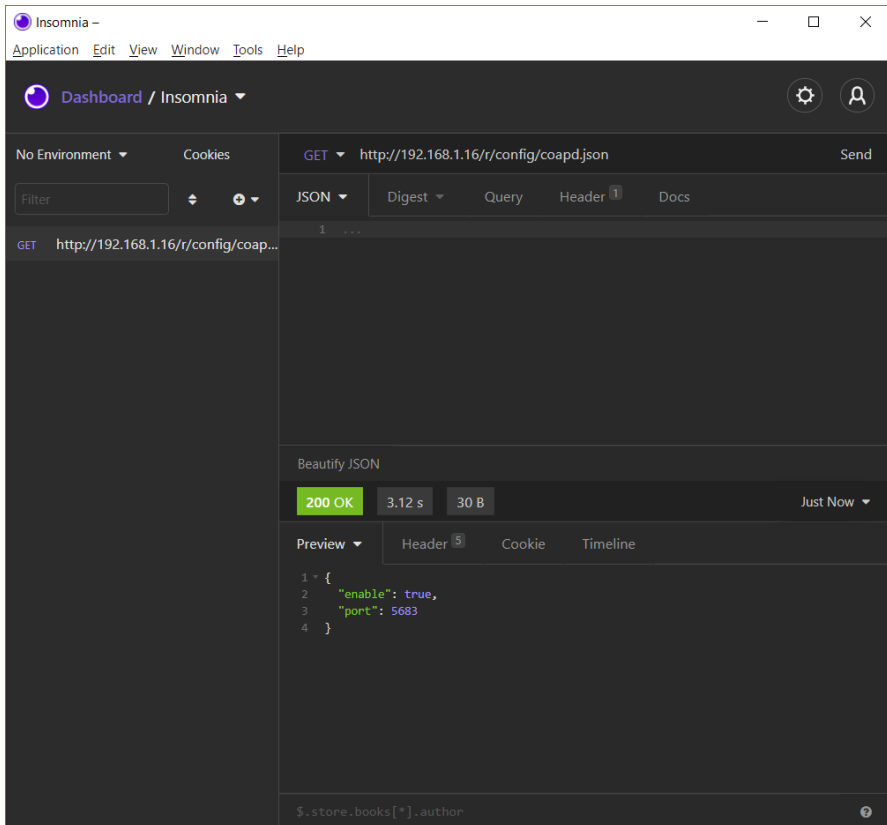

The screenshot displays the Insomnia REST client interface. The top bar shows the application name 'Insomnia' and standard window controls. Below the menu bar, the 'Dashboard / Insomnia' view is active. The main workspace is divided into several sections:

- Request Section:** Shows a GET request to the URL `http://192.168.1.16/r/config/coapd.json`. The request body is empty.
- Response Section:** Shows a successful response with a status of **200 OK**, a response time of **3.12 s**, and a body size of **30 B**. The response is displayed in a JSON format, which has been beautified.
- Preview Section:** Shows the JSON response content:

```
1 * {
2   "enable": true,
3   "port": 5683
4 }
```

The interface also includes a 'Send' button, a 'Filter' input, and various tabs for viewing the response (JSON, Digest, Query, Header, Docs). The bottom status bar shows the path `$.store.books[*].author`.

11.5 Syslog

Syslog functions are **only** applicable for the following LioN-X variants:

- ▶ 0980 XSL 3912-121-007D-00F
- ▶ 0980 XSL 3912-121-007D-01F

The LioN-X multiprotocol variants provide a Syslog client which can connect with a configured Syslog server and is able to log messages.

Syslog is a platform-independent standard for logging messages. Each message contains a timestamp as well as information about the severity level and the subsystem. The Syslog protocol RFC5424 is based on the Server-Client principle and lets machines and devices send messages in the network and collect them centrally. (For more details on the used syslog standard, please refer to <https://datatracker.ietf.org/doc/html/rfc5424>.)

LioN-X supports the storage of 256 messages in a ring buffer which are sent to the configured Syslog server. When the ring is full with 256 messages, the oldest message is always replaced by the newly arriving messages. All messages can be saved on the Syslog server. The Syslog client of the IO-Link Master will not store any message permanently.

11.5.1 Syslog configuration

In **delivery state**, Syslog functions are **disabled**. The Syslog client can be configured either using the Web interface or directly via a JSON object sent in an HTTP request. For more information see chapter [Syslog configuration - Quick start guide](#) on page 202.

The configuration URL is:

```
http://[ip-address]/w/config/syslog.json
```

The configuration can also read back as a JSON file:

```
http://[ip-address]/r/config/syslog.json
```

The configuration is a JSON object. Each JSON member is a configuration element. The object must not contain all elements. Only the provided elements will be changed. The configuration changes apply only after a device restart.

The following configuration elements are available (default values in bold):

Element	Data type	Description	Example data
syslog-enable	boolean	Master switch for the Syslog client	true / false
global-severity	integer	<u>Severity level of Syslog client</u> 0 – Emergency 1 – Alert 2 – Critical 3 – Error 4 – Warning 5 – Notice 6 – Info 7 – Debug The client will log all messages of severity according to the setting, including all below levels.	0/1/2/ 3 /4/5/6/7
server-address	string (IP address)	IP address of the Syslog server	192.168.0.51 (Default: null)
server-port	integer (0 to 65535)	Server port of the Syslog server	514
server-severity	integer (0 to 7)	<u>Severity level of Syslog server</u> 0 – Emergency 1 – Alert 2 – Critical 3 – Error 4 – Warning 5 – Notice 6 – Info 7 – Debug	0/1/2/ 3 /4/5/6/7

Table 69: Syslog configuration

Syslog response:

The resulting response is a JSON object with a "status" field. Status should be "0" if no error occurred, and "-1" if there is an error.

In case of an error, the response contains an error array.

The error array contains an error object for each error occurred. The object consists of a field "Element" which names the config element that caused the error, and of a field "Message" for the error message.

Examples:

```
{ "status": -1, "error": [ { "Element": "upcua-enable", "Message": "Boolean
expected" } ] }

{ "status": 0 }

{ "status": -1, "error": [ { "Element": "root", "Message": "Not a JSON
object" } ] }
```

11.5.2 Syslog configuration - Quick start guide

i Attention: Lumberg Automation™ is not responsible for any content of the referenced Web pages and provides no warranty for any functionality of the named third party software.

11.5.2.1 Syslog configuration via JSON

1. Depending on your application case, download and install *Insomnia* or a comparable application: <https://insomnia.rest/download/>

2. Configure Syslog:

POST: [IP-address]/w/config/syslog.json

The screenshot shows the Insomnia REST client interface. The top bar displays "Insomnia -" and standard window controls. Below the menu bar, the "Dashboard / Insomnia" view is active. The main area shows a POST request to "http://192.168.1.16/w/config/syslog.json". The request body is a JSON object:

```
1 {
2   "syslog-enable": true,
3   "global-severity": 7,
4   "server-address": "192.168.1.51",
5   "server-port": 514,
6   "server-severity": 7
7 }
```

The response is a "200 OK" status with a response time of "901 ms" and a body size of "14 B". The response body is shown in the "Preview" tab as:

```
1 {
2   "status": 0
3 }
```

3. Read Syslog configuration:

GET: [IP-address]/r/config/syslog.json

The screenshot shows the Insomnia REST client interface. The top bar displays the application name 'Insomnia' and standard window controls. Below the top bar, there is a navigation menu with 'Dashboard / Insomnia'. The main interface is divided into several sections:

- Environment:** 'No Environment' and 'Cookies'.
- Request:** Method 'GET' and URL 'http://192.168.1.16/r/config/syslog.json'. A 'Send' button is visible.
- Response:** The response is displayed in JSON format. The content is:

```
1 {
2   "syslog-enable": true,
3   "global-severity": 7,
4   "server-address": "192.168.1.51",
5   "server-port": 514,
6   "server-severity": 7
7 }
```
- Status:** '200 OK', '64.2 ms', and '118 B'. A 'Just Now' indicator is present.
- Preview:** A 'Preview' tab is active, showing the JSON response content.
- Footer:** A small text indicator '\$.store.books[*].author' is visible at the bottom.

11.6 Network Time Protocol (NTP)

The NTP function is **only** applicable for the following LioN-X variant:

- ▶ 0980 XSL 3912-121-007D-00F
- ▶ 0980 XSL 3912-121-007D-01F

The LioN-X multiprotocol variants provide an NTP client (version 3) which can connect with a configured NTP server and is able to synchronize the network time at a configurable interval.

NTP is a network protocol which uses UDP datagrams to send and receive timestamps in order to synchronize with a local clock. The NTP protocol RFC1305 is based on the Server-Client principle and exclusively supplies the synchronization with Coordinated Universal Time (UTC). (For more details on the used NTP standard, please refer to <https://datatracker.ietf.org/doc/html/rfc1305>.)

11.6.1 NTP configuration

In **delivery state**, the NTP client is **disabled**. The NTP client can be configured either using the Web interface or directly via a JSON object sent in an HTTP request. For more information see chapter [NTP configuration - Quick start guide](#) on page 206.

The configuration URL is:

```
http://[ip-address]/w/config/ntpc.json
```

The configuration can also read back as a JSON file:

```
http://[ip-address]/r/config/ntpc.json
```

The configuration is a JSON object. Each JSON member is a configuration element. The object must not contain all elements. Only the provided elements will be changed. The configuration changes apply only after a device restart.

The following configuration elements are available (default values in bold):

Element	Data type	Description	Example data
NTP client state	boolean	Master switch for the NTP client	true / false
Server address	string	IP address of the NTP server	192.168.1.50
Server port	integer	Port of the NTP server	123
Update interval	integer	Interval at which the client will connect with the configured NTP server (see table row "Server address"). Note: This value is in seconds.	1/2/10/ 60

Table 70: NTP configuration

NTP response:

The resulting response is a JSON object with a "status" field. Status should be "0" if no error occurred, and "-1" if there is an error.

In case of an error, the response contains an error array.

The error array contains an error object for each error occurred. The object consists of a field "Element" which names the configuration element that caused the error, and of a field "Message" for the error message.

Examples:

```
{ "status": -1, "error": [{"Element": "ntpc-enable", "Message": "Boolean expected"}] }
{ "status": 0 }
{ "status": -1, "error": [{"Element": "root", "Message": "Not a JSON object"}] }
```

11.6.2 NTP configuration - Quick start guide

i Attention: Lumberg Automation™ is not responsible for any content of the referenced Web pages and provides no warranty for any functionality of the named third party software.

11.6.2.1 NTP configuration via JSON

1. Depending on your application case, download and install *Insomnia* or a comparable application: <https://insomnia.rest/download/>

2. Configure NTP:

POST: [IP-address]/w/config/ntpc.json

The screenshot shows the Insomnia REST client interface. The top bar displays "Insomnia - Insomnia" and "Application Edit View Window Tools Help". The main area is divided into several sections:

- Environment:** "No Environment" and "Cookies".
- Request:** Method "POST" and URL "http://192.168.1.16/w/config/ntpc.json".
- Request Body:** JSON format with the following content:

```
1 {
2   "enable": false,
3   "server-address": "192.168.1.8",
4   "server-port": 123,
5   "update-interval": 5
6 }
```
- Response:** Status "200 OK", response time "75.4 ms", and content length "14 B".
- Response Body:** Preview of the response JSON:

```
1 {
2   "status": 0
3 }
```

3. Read NTP configuration:

GET: [IP-address]/r/config/ntpc.json

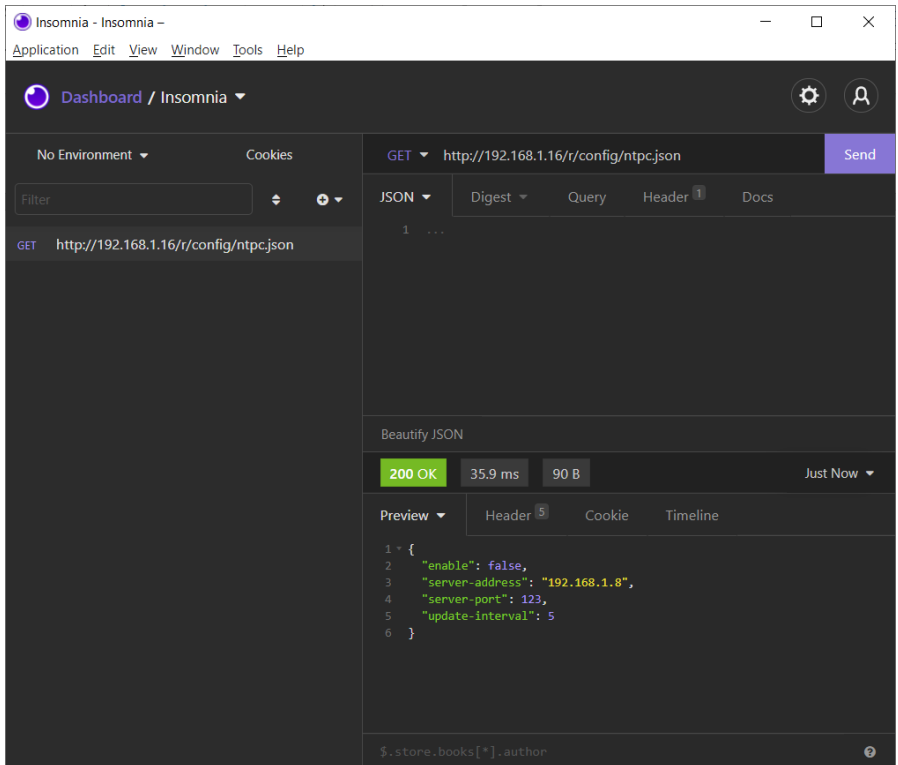

The screenshot displays the Insomnia REST client interface. The top bar shows the application name "Insomnia" and standard window controls. Below the menu bar, the "Dashboard / Insomnia" header is visible. The main workspace is divided into several sections:

- Environment:** "No Environment" is selected.
- Request:** A GET request to "http://192.168.1.16/r/config/ntpc.json" is defined.
- Response:** The response is displayed in JSON format, showing a 200 OK status, a response time of 35.9 ms, and a body size of 90 B. The JSON content is:

```
1 * {
2   "enable": false,
3   "server-address": "192.168.1.8",
4   "server-port": 123,
5   "update-interval": 5
6 }
```
- Preview:** A preview of the JSON response is shown, with a "Header" tab selected.

12 The integrated Web server

LioN-X and the LioN-Xlight variants are equipped with an integrated Web server which makes functions for the device configuration and the display of status and diagnostic information available via a Web interface.

The Web interface provides an overview of the configuration and status of the device. It is also possible to use the Web interface to trigger a reboot, reset to the factory defaults, or perform a firmware update.

Enter "http://" followed by the IP address, such as "http://192.168.1.5", in your Web browser's address bar. If the status page of the device is not displayed, check your browser and firewall settings.

12.1 LioN-X 0980 XSL... variants

12.1.1 The Status page



Lion-X Web Interface

Status Ports System User Contact

Status

Device Overview

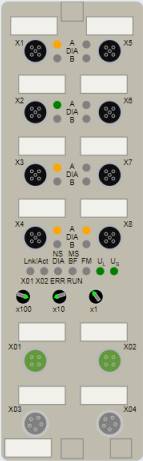

Device Information

Name LioN-X 8xIO-Link Class A with Multiprotocol
 Application Version 10.0.1.26228
 Fieldbus Version 1.0.0.0
 Bus OPERATE

Device Diagnosis

Forcemode Forcing is locked. Locked

Port Information

Channel	Type	Configuration	State	Dia	Details
X1 A	IO-Link	Digital Input 1 Bit In	Off		
X1 B	Digital Input/Output	Digital Input 1 Bit In	Off		ⓘ
X2 A	IO-Link	IO-Link 4 Bytes In, 4 Bytes Out	Operate		
X2 B	Digital Input/Output	Digital Input 1 Bit In	Off		
X3 A	IO-Link	Digital Output 1 Bit Out	Off		ⓘ
X3 B	Digital Input/Output	Digital Input 1 Bit In	Off		
X4 A	IO-Link	Digital Output 1 Bit Out	Off		ⓘ
X4 B	Digital Input/Output	Digital Input 1 Bit In	Off		
X5 A	IO-Link	Digital Input 1 Bit In	Off		ⓘ
X5 B	Digital Input/Output	Digital Input 1 Bit In	Off		
X6 A	IO-Link	Digital Input 1 Bit In	Off		ⓘ
X6 B	Digital Input/Output	Digital Input 1 Bit In	Off		
X7 A	IO-Link	Digital Input 1 Bit In	Off		ⓘ
X7 B	Digital Input/Output	Digital Input 1 Bit In	Off		
X8 A	IO-Link	Digital Output 1 Bit Out	Off		ⓘ
X8 B	Digital Input/Output	Digital Input 1 Bit In	Off		

The status page provides a quick overview of the current state of the device.

The left side shows a graphical representation of the module with all its LEDs and the positions of the rotary encoding switches.

The right side shows the "Device Information" table with some basic data for the module; for example, the variant, the cyclic communication status and a diagnostic indicator. The indicator shows whether diagnostics for the module exist.

The "Port Information" table shows the configuration and state of the I/O ports.

12.1.2 The Ports page



Lion-X Web Interface

Status Ports System User Contact

Port Details

Show details for port

X1
 X2
 X3
 X4
 X5
 X6
 X7
 X8

Port Information		IO-Link	
Forcemode	Forcemode off	Vendor ID	362
Port	X2	Device ID	3674114
Type	IO-Link	Vendor Name	BELDEN Deutschland GmbH
Dia		Vendor Text	www.beldensolutions.com
Port Diagnosis		Product Name	0960 IOL 381-001
<ul style="list-style-type: none"> No diagnosis 		Product ID	93492002
Pin 4 / Channel A		Product Text	Lion-P IO-Link I/O-Hub, 16DI
Function	IO-Link 4 Bytes In, 4 Bytes Out	Serial No.	123
State	Operate	HW Revision	V1
Pin 2 / Channel B		FW Revision	V3.0.0.0
Function	Digital Input 1 Bit In	Speed	COM3
State	OFF	Cycle time	1000
IO-Link Events		Application Name (Tag)	*** <input type="text"/> <input type="button" value="Set"/>
<ul style="list-style-type: none"> No events 		Input Data	01 00 00 00 <input type="text"/> <input type="button" value="Hex"/>
		Output Data	00 00 00 00 <input type="text"/> <input type="button" value="Hex"/>
		Index:	<input type="text"/> Subindex: <input type="text"/>
			<input checked="" type="radio"/> Dec <input type="radio"/> Hex
			<input type="button" value="Read"/> <input type="button" value="Write"/> <input type="button" value="System Command"/>
		Parameter Read/Write	<input type="text"/> <input type="button" value="Hex"/>

The page shows detailed port information. In the field **Port Diagnosis**, incoming and outgoing diagnostics are displayed as clear text. **Pin 2** and **Pin 4** contain information about the configuration and state of the port. For IO-Link ports, additional information relating to the connected sensor and the process data is displayed.

12.1.3 The System page



Lion-X Web Interface

Status Ports System User Contact

System

General Information

Firmware	
Application Version	10.0.1.26228
Fieldbus Version	1.0.0.0
Device	
Name	LioN-X 8xIO-Link Class A with Multiprotocol
Product ID	0980 XSL 3912-121-007D-00F
Ordering Number	935700001
Hardware	1.0
Serial Number	123456
Production Date	2020-12-24T12:00:00Z
Ethernet	
MAC Address	3C:B9:A6:20:05:30
Network	
IP-Address	192.168.0.5
Subnetmask	255.255.255.0
Gateway	192.168.0.5
Source	Manual
Fieldbus	
Name	PROFINET
State	OPERATE

IP Settings

Parameter	Settings
IP-Address	0 . 0 . 0 . 0
Subnet Mask	0 . 0 . 0 . 0
Gateway	0 . 0 . 0 . 0
Startup configuration	<input checked="" type="radio"/> Static <input type="radio"/> DHCP

Submit

MQTT Config	OPC UA Server Config
Mqtt state	Opcau state
Broker	Port
Port	Anonymous login
Base Topic	Listen for Commands
Auto Publish	Process Forcing
Publish Interval (ms)	Change config
Publish Identity	Device Reset
Publish Config	Syslog
Publish Status	Syslog state
Publish Process	Global severity
Publish Devices	Server address
Will State	Server port
Will Topic	Server severity
Listen for Commands	CoAP
Process Forcing	CoAP state
Change Config	Port
Device Reset	
QOS	

Restart device

Confirm to restart the device. All connections will be closed.

Restart

Reset configuration to factory defaults

Restoring factory settings affects all network parameters, including fieldbus specific settings. All network connections will be closed.

Note: If the module has rotary switches, the new IP address is equivalent to the rotary switch position.

Confirm to reset the device. All configuration data will be overwritten by default values!

Factory Reset

Firmware update

FW-Update

The System page shows the basic information for the module like Firmware version, Device information, Ethernet, Network and Fieldbus information.

Restart Device

The module initializes a software reset.

Reset to Factory Settings

The module restores to the default factory settings.

IP Settings

Use this parameter to change the current IP address of the module.

For PROFINET, this is only useful during commissioning. Normally, the PLC sets the IP address at start-up by detecting the PROFINET module via its device name.

Firmware Update

The module initializes a Firmware update.

For a firmware update choose the *.ZIP container available on our website or ask our support team. Afterwards follow the instructions shown on your screen.

For updates from firmware version 10.x to 11.x please use the LioN Management Suite (LMS). The LMS provides most updates from version 10.x to 11.x (in May 2022).

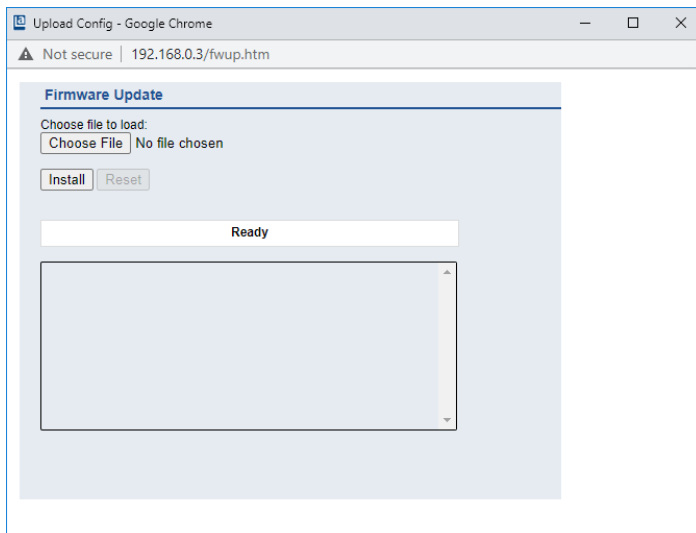

12.1.4 The User page

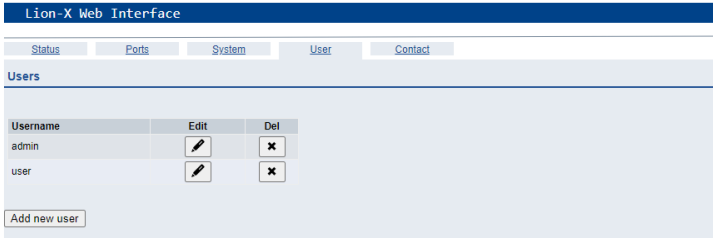

The User page provides the user management of the Web interface. New users with access rights "Admin" or "Write" can be added here. For security reasons please change the default admin password immediately after configuring the device.

Default user login data:

- ▶ User: admin
- ▶ Password: private

12.2 LioN-Xlight 0980 LSL... variants

12.2.1 The System page



LioN-X Webserver

System Contact

System

General Information

Firmware
Version 10.0.0

Device
Name LioN-Xlight 8xIO-Link Class A with Profinet
Product ID 0980 LSL 3010-121-0006-001
Ordering Number 935701001
Hardware 1.0
Serial Number 123456
Production Date 2020-12-24T12:00:00Z

Ethernet
MAC Address 3C:B9:A6:20:05:30

Network
IP-Address 192.168.0.3
Subnetmask 255.255.255.0
Gateway 192.168.0.3

Fieldbus
Name PROFINET
State OPERATE

IP Settings

Parameter	Settings
IP-Address	192 . 168 . 0 . 3
Subnet Mask	255 . 255 . 255 . 0
Gateway	192 . 168 . 0 . 3

Startup configuration Static DHCP

Restart device

Confirm to restart the device. All connections will be closed.

Reset configuration to factory defaults

Restoring factory settings affects all network parameters, including fieldbus specific settings. All network connections will be closed.

Note: If the module has rotary switches, the new IP address is equivalent to the rotary switch position.

Confirm to reset the device. All configuration data will be overwritten by default values!

Firmware update

The System page shows the basic information for the module like Firmware version, Device information, Ethernet, Network and Fieldbus information.

Restart Device

The module initializes a software reset.

Reset to Factory Settings

The module restores to the default factory settings.

IP Settings

Use this parameter to change the current IP address of the module.

For PROFINET, this is only useful during commissioning. Normally, the PLC sets the IP address at start-up by detecting the PROFINET module via its device name.

Firmware Update

The module initializes a Firmware update.

For a firmware update choose the *.ZIP container available on our website or ask our support team. Afterwards follow the instructions shown on your screen.

For updates from firmware version 10.x to 11.x please use the LioN Management Suite (LMS). The LMS provides most updates from version 10.x to 11.x (in May 2022).

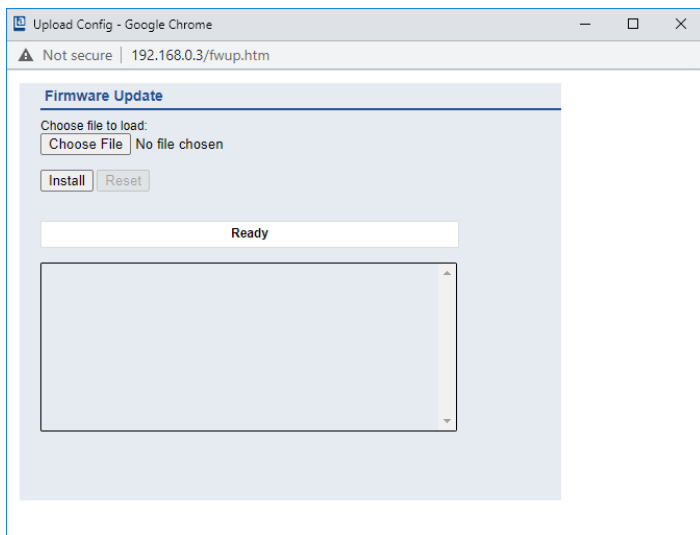

13 IODD

IODD functions are **only** applicable for the following device variants:

- ▶ 0980 XSL 3912-121-007D-00F
- ▶ 0980 XSL 3912-121-007D-01F

The **IO Device Description** (IODD) is a set of files formally describing an IO-Link Device. The IODD is created by the vendor and is mandatory for each IO-Link Device.

Belden LioN-X IO-Link Masters with the "IODD on Module" functionality are ready to use IODDs in order to make the IO-Link Device configuration much more easier and the process data human readable in a better way. IODDs can be uploaded via the Web Interface and remanently stored on the IO-Link Master afterwards.

If a corresponding IO-Link Device is connected, the stored IODD is used to provide a user friendly configuration page, where all parameters of the device can be viewed and edited. Additionally, according to the IODD, the process data will also be formatted and displayed to the user.

13.1 IO-Link Device parameters and ISDU requests

Every IO-Link Device provides parameters that can be read and written via the special IO-Link service ISDU (**I**ndexed **S**ervice **D**ata **U**nit).

Every parameter is addressed by an index. Sub-indices are possible but optional. Some parameters (most of them read-only) are mandatory for IO-Link devices and can be found always on the same indices (See *Table B.8* in the *IO-Link Interface and System Specification*: https://io-link.com/share/Downloads/Package-2020/IOL-Interface-Spec_10002_V113_Jun19.pdf).

A vendor can use additional parameters and therefore more indices for their devices in order to provide additional configuration options. These vendor specific parameters can be described in an IODD. The "IODD on Module" feature of the LioN-X IO-Link Masters can read and parse this information out of an IODD and use it to provide the user viewing and editing options

for vendor specific parameters without any additional knowledge about the vendor specific device features.

13.2 Web GUI functionality

All of the "IODD on Module" features are accessible via the LioN-X Web interface.

13.2.1 Port Details page

lumbergautomation
A BELDEN BRAND

LioN-X Web Interface

Status Ports System User Contact

Port Details

Show details for port

X1 X2 X3 X4 X5 X6 X7 X8

Port Information		IO-Link	
Forcemode	Forcemode off	Vendor ID	362
Port	X2	Device ID	3674114
Type	IO-Link	Vendor Name	BELDEN Deutschland GmbH
Dia		Vendor Text	www.beldensolutions.com
Port Diagnosis		Product Name	0960 IOL 381-001
• No diagnosis		Product ID:	934992002
Pin 4 / Channel A		Product Text	LioN-P IO-Link I/O-Hub, 16DI
Function	IO-Link 4 Bytes In, 4 Bytes Out	Serial No.	x42n
State	Operate	HW Revision	V1
Pin 2 / Channel B		FW Revision	V3.0.0.0
Function	Inactive	Speed	COM3
State	Inactive	Cycle time	1000
IO-Link Events		IODD	<input type="button" value="Upload"/>
• No events			<input type="button" value="Configure device"/>
		Application Name (Tag)	<input type="text" value="appTag7"/>
			<input type="button" value="Set"/>
			<input type="text" value="83 c0 00 80"/>
			<input type="button" value="HEX"/>
		Name	Value
		Port X1A	false
		Port X1B	false
		Port X2A	false
		Port X2B	false
		Port X3A	false
		Port X3B	false

The Port Details Page shows all information about the selected port. In the left column, all port and channel specific information is displayed. If the port is configured as IO-Link and there is an IO-Link Device connected, all IO-Link information for the connected device is displayed in the right column.

IODD buttons

The row called *IODD* provides access to the "IODD on Module" features. The button *UPLOAD* will let the user upload an IODD file into the module, regardless of the original device the IODD has been designed for.

The maximum number of IODDs is limited due to storage space. If there is no more space left for new IODDs, there will be an error message. In this case, navigate to the IODD Management page to delete IODDs which are no longer used.

If there is a matching IODD for the currently connected device already stored in the system, the button *CONFIGURE* is shown in the interface. By clicking this button, the Parameter Page will open to configure the device.

Process data

For every connected IO-Link Device, raw process data for input and output direction (set of bytes) is on display.

If a matching IODD providing information about process data is already stored in the system, this data will also be displayed in a user-friendly format according to the IODD.

13.2.2 Parameters page

IODD - Device configuration

Diagnosis

Parameter	Value	Unit	Min	Max	Description
Device Status	Device is OK				Indicator for the current device condition and diagnosis state.

Identification

Parameter	Value	Unit	Min	Max	Description
Vendor Name	BELDEN Deutschland GmbH				The vendor name that is assigned to a Vendor ID.
Vendor Text	www.beldensolutions.com				Additional information about the vendor.
Product Name	0960 IOL 381-001				Complete product name.
Product ID	934992002				Vendor-specific product or type identification (e.g., item number or model number).
Product Text	LioN-P IO-Link I/O-Hub, 16DI				Additional product information for the device.
Serial Number	x42n				Unique, vendor-specific identifier of the individual device.
Hardware Revision	V1				Unique, vendor-specific identifier of the hardware revision of the individual device.
Firmware Revision	V3.0.0.0				Unique, vendor-specific identifier of the firmware revision of the individual device.
Application-specific Tag	<input type="text" value="appTag7"/>		0	32	Possibility to mark a device with user- or application-specific information.
Function Tag	<input type="text" value="functionTag5"/>		0	32	
Location Tag	<input type="text" value="locationTag5"/>		0	32	

Parameter

Parameter	Value	Unit	Min	Max	Description
User Serial Number	<input type="text" value="x42n"/>		0	16	
Module Identification ID	<input type="text" value="1"/>		0	127	

General Device Settings

Parameter	Value	Unit	Min	Max	Description
I/O data mapping	<input type="text" value="LioN-P"/>				
DIS-PRM-RST	<input type="text" value="enable parameter reset"/>				

General Diagnostic Settings

Parameter	Value	Unit	Min	Max	Description
Disable peripheral diagnosis	<input type="text" value="enable diagnosis"/>				

Input Filter

Parameter	Value	Unit	Min	Max	Description
Port X1A	<input type="text" value="off"/>				
Port X1B	<input type="text" value="0.5ms"/>				
Port X2A	<input type="text" value="1ms"/>				
Port X2B	<input type="text" value="2ms"/>				
Port X3A	<input type="text" value="2ms"/>				

The parameters page "IODD – Device configuration" shows all parameters which are provided by the IODD of the device. That means the parameter set is variable and depends on the connected IO-Link Device.

The stored IODD reads the parameter meta data, such as names, units, min/max values, descriptions etc. The values will be obtained directly from the connected device. For that reason it may take several seconds until the page is updated.

If not already saved into the browser, you will be asked for your credentials to continue. A valid user access with Web Interface group membership is needed in order to edit the device parameters. After the registration, enabled values can be changed. Disabled values cannot be changed and may be

marked as "read-only" in the IODD. All values are directly written back to the device after any change.

Limitations

- ▶ Editing parameter values will directly change them inside the connected device. No parameter server action is triggered by that.
- ▶ There is a maximum size of the IODD in order to be uploaded into the system. This depends on several values, such as file size, parameter count, nesting levels etc.

13.2.3 IODD Management page

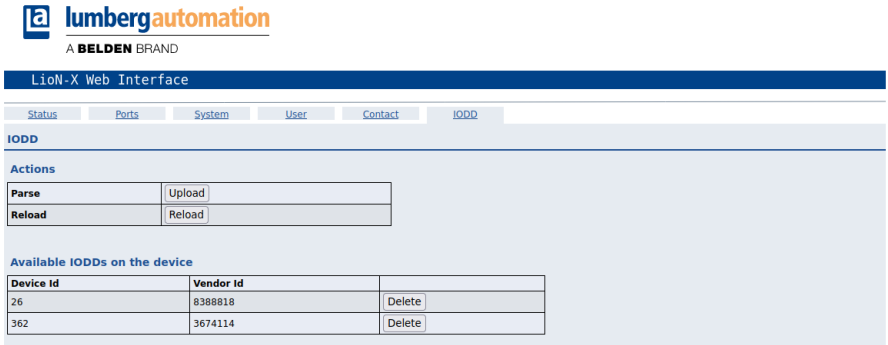

lumbergautomation
A BELDEN BRAND

Lion-X Web Interface

Status Ports System User Contact IODD

IODD

Actions

Parse	Upload
Reload	Reload

Available IODDs on the device

Device Id	Vendor Id	
26	8388818	Delete
362	3674114	Delete

The IODD Management Page can be accessed via the System page displaying all IODDs that are currently stored in the system. All IODDs matching connected devices are marked. On the IODD Management page, you can manually delete any IODD in the system.

Standard Definitions File

IODDs are usually referencing to a Standard Definitions File. The latest Standard Definitions File is already pre-installed on the system when the device is shipped. It can also be updated manually by clicking the button "Upload Standard Definitions File".

14 Technical data

The following sections give an overview of the most important functional data needed to operate the device. For further information and detailed technical data, see the respective **Data Sheet** of your required product in the product specific download area on catalog.belden.com.

14.1 General

Protection class (Only applies if the connectors are screwed together or if protective caps are used.) ⁴	IP65 IP67 IP69K	
Ambient temperature (during operation and storage)	0980 XSL 3x12-121... 0980 XSL 3x13-121...	-40 °C .. +70 °C (-40 °F .. +158 °F)
	0980 LSL 3x11-121...	-20 °C .. +60 °C
	0980 LSL 3x10-121...	(-4 °F .. +140 °F)
Weight	LioN-X 60 mm	approx. 500 gr. (17.6 oz)
Ambient moisture	Max. 98% RH (For UL applications: Max. 80% RH)	
Housing material	Die-cast zinc	
Surface finish	Frosted nickel	
Flammability class	UL 94 (IEC 61010)	
Vibration resistance (oscillation) DIN EN 60068-2-6 (2008-11)	15 g / 5-500 Hz	
Shock resistance DIN EN 60068-2-27 (2010-02)	50 g / 11 ms +/- X,Y,Z	
Fastening torques	M4 fixing screws	1 Nm
	M4 ground connection	1 Nm
	M12 connector	0.5 Nm
Permitted cables	Ethernet cables according to IEEE 802.3, min. CAT 5 (shielded) Max. length of 100 m, not routed out of facility (= local network)	

Table 71: General information

⁴ Not under UL investigation.

14.2 PROFINET protocol

Protocol	PROFINET IO device V2.35
Conformance Class	C (CC-C)
Netload Class	III
Update cycle	1 ms
GSDML file	GSDML-V2.3x-LumbergAutomation-LioN-Xyyyyymmdd.xml
Transmission rate	100 Mbit/s, full duplex
Transmission procedure Autonegotiation	100BASE-TX is supported
Vendor ID	16A _H
Device ID	0x0400 (same for all LioN-X variants)
Supported Ethernet protocols	<ul style="list-style-type: none"> Ping ARP LLDP SNMPv1 (network diagnostics) <ul style="list-style-type: none"> ▶ Read Community: public ▶ Write Community: private DCP HTTP TCP/IP MRP Client
PROFINET feature	<ul style="list-style-type: none"> Fast Start UP (Prioritized startup) Shared Device
Switch functionality	<ul style="list-style-type: none"> Integrated IRT is supported
PROFINET interface Connections Autocrossing	<ul style="list-style-type: none"> 2 M12 sockets, 4-pin, D-coded (see pin assignments) 2 M12 Hybrid male/female, 8-pin is supported
Electrically isolated Ethernet ports -> FE	2000 V DC

Table 72: PROFINET protocol

14.3 Power supply of the module electronics/sensors

Port X03, X04	M12-L-coded Power, connector/socket, 5-pole Pin 1 / Pin 3		
Nominal voltage U_S	24 V DC (SELV/PELV)		
Current U_S	Max. 16 A		
Voltage range	21 .. 30 V DC		
Power consumption of module electronics	Typically 160 mA (+/-20 % at U_S nominal voltage)		
Power supply interruption	Max. 10 ms		
Voltage ripple U_S	Max. 5 %		
Current consumption sensor system (L+ / Pin 1)	0980 XSL 3912-121...	Port X1 .. X8 (Pin 1)	max. 4 A per port (at $T_{\text{ambient}} = 30^\circ \text{C}$)
	0980 LSL 3x11-121...	Port X1 .. X8 (Pin 1)	max. 2 A per port (at $T_{\text{ambient}} = 30^\circ \text{C}$)
	0980 LSL 3x10-121...	Port X1 .. X4 (L+ / Pin 1)	max. 2 A per port (at $T_{\text{ambient}} = 30^\circ \text{C}$)
		Port X5 .. X8 (Pin 1)	max. 0.7 A in total for ports X5 .. X8
Voltage level of the sensor power supply	Min. ($U_S - 1.5 \text{V}$)		
Short circuit/overload protection of sensor supply	Yes, per port		
Reverse polarity protection	Yes		
Operational indicator (U_S)	LED green:	$18 \text{V} (+/- 1 \text{V}) < U_S$	
	LED red:	$U_S < 18 \text{V} (+/- 1 \text{V})$	

Table 73: Information on the power supply of the module electronics/sensors

14.4 Power supply of the actuators

14.4.1 IO-Link Class A devices (U_L)

Nominal voltage U_L	24 V DC (SELV/PELV)
Voltage range	18 .. 30 V DC
Current U_L	Max. 16 A
Voltage ripple U_L	Max. 5 %
Reverse polarity protection	Yes
Operational indicator (U_L)	LED green: 18 V (+/- 1 V) < U_L LED red: U_L < 18 V (+/- 1 V) or U_L > 30 V (+/- 1 V) * if "Report U_L supply voltage fault" is enabled.
Port X03, X04	M12_L-coded Power, connector/socket, 5-pole Pin 2 / Pin 4

Table 74: Information on the power supply of the actuators

14.5 I/O ports Channel A (Pin 4)

0980 XSL 3912-121...	Port X1 .. X8	Class A	IOL, DI, DO	M12 socket, 5-pin, Pin 4
0980 LSL 3x11-121...	Port X1 .. X8	Class A	IOL, DI, DO	
0980 LSL 3x10-121...	Port X1 .. X4	Class A	IOL, DI, DO	
	Port X5 .. X8	—	—, DI, —	

Table 75: IO-Link Master ports: Functional overview for Ch. A (Pin 4)

14.5.1 Configured as digital input, Ch. A (Pin 4)

Input connection	0980 XSL 3912-121...		Type 1 as per IEC 61131-2
	0980 LSL 3x11-121...		
	0980 LSL 3x10-121...		
Nominal input voltage	24 V DC		
Input current	Typically 3 mA		
Channel type	Normally open, p-switching		
Number of digital inputs	0980 XSL 3912-121...	X1 .. X8	8
	0980 LSL 3x11-121...		
	0980 LSL 3x10-121...		
Status indicator	yellow LED		
Diagnostic indicator	red LED per channel		

Table 76: I/O ports Ch. A (Pin 4) configured as digital inputs

14.5.2 Configured as digital output, Ch. A (Pin 4)

i Attention: For variants 0980 XSL 3912-121-007D-00F and 0980 XSL 3912-121-007D-01F, the digital outputs of Channel A are **supplied by the U_L power** when parameterized to "High-Side Switch" mode.

i Attention: For variants 0980 LSL 3010-121-0006-001 and 0980 LSL 3011-121-0006-001, the digital outputs of Channel A are **supplied by the U_S power**.

Output type	normally open, p-switching (parameterized to "High-Side Switch" mode)	
Nominal output voltage per channel		
Signal status "1"	min. ($U_S - 1\text{ V}$) or min. ($U_L - 1\text{ V}$) depending on the device variant	
Signal status "0"	max. 2 V	
Max. output current per device	0980 XSL 3912-121...	9 A (power supplied via U_L)
	0980 LSL 3x11-121...	4 A (power supplied via U_S)
	0980 LSL 3x10-121...	2 A (power supplied via U_S)
Max. output current per channel ⁵	0980 XSL 3912-121... (X1 .. X8)	2 A (power supplied via U_S)
	0980 LSL 3x11-121... (X1 .. X8)	0.5 A (power supplied via U_S)
	0980 LSL 3x10-121... (X1 .. X4)	0.25 A for UL applications

⁵ Max. 2.0 A per channel; for every port pair X1/X2, X3/X4, X5/X6, X7/X8 max. 6.5 A (for **UL applications** max. 5.0 A); for the whole port group X1 .. X8 max. 9.0 A in total (with derating).

Short-circuit/overload protected	yes/yes	
Behavior in case of short circuit or overload	deactivation with automatic power-on (parameterized)	
Number of digital outputs	0980 XSL 3912-121... (X1 .. X8)	8
	0980 LSL 3x11-121... (X1 .. X8)	
	0980 LSL 3x10-121... (X1 .. X4)	4
Status indicator	yellow LED per output	
Diagnostic indicator	red LED per channel	

Table 77: I/O ports Ch. A (Pin 4) configured as digital outputs

14.5.3 Configured as IO-Link port in COM mode, Ch. A

IO-Link Master specification	v1.1.3 ready, IEC 61131-9	
Communication rates	4.8 kbaud (COM 1) 38.4 kbaud (COM 2) 230.4 kbaud (COM 3)	
Line lengths in the IO-Link Device	max. 20 m	
Number of IO-Link ports	0980 XSL 3912-121... (X1 .. X8)	8
	0980 LSL 3x11-121... (X1 .. X8)	8
	0980 LSL 3x10-121... (X1 .. X4)	4
Min. IO-Link cycle time	400 µs	

Table 78: Configured as IO-Link port in COM mode

14.6 I/O ports Channel B (Pin 2)

0980 XSL 3912-121...	Port X1 .. X8	Class A	DI, DO	M12 socket, 5-pin, Pin 2
0980 LSL 3x11-121...	Port X1 .. X8	Class A	DI	
0980 LSL 3x10-121...	Port X1 .. X4	Class A	DI	
	Port X5 .. X8	–	DI	

Table 79: IO-Link Master ports: Functional overview for Ch. B (Pin 2)

14.6.1 Configured as a digital input, Ch. B (Pin 2)

Input connection	0980 XSL 3912-121...		Type 1 as per IEC 61131-2
	0980 LSL 3x11-121...		
	0980 LSL 3x10-121...		
Nominal input voltage	24 V DC		
Input current	Typically 3 mA		
Channel type	Normally open, p-switching		
Number of digital inputs	0980 XSL 3912-121...	X1 .. X8	8
	0980 LSL 3x11-121...	X1 .. X8	8
	0980 LSL 3x10-121...	X1 .. X8	8
Status indicator	white LED		
Diagnostic indicator	red LED per channel		

Table 80: I/O ports Ch. B (Pin 2) configured as digital inputs

14.6.2 Configured as a digital output, Ch. B (Pin 2)



Attention: For variants 0980 XSL 3912-121-007D-00F and 0980 XSL 3912-121-007D-01F, the digital outputs of Channel B are **supplied by the U_L power.**



Attention: For variants 0980 LSL 3010-121-0006-001 and 0980 LSL 3011-121-0006-001, the digital outputs of Channel B are **supplied by the U_S power.**

Output type	normally open, p-switching	
Nominal output voltage per channel Signal status "1" Signal status "0"	min. ($U_S - 1\text{ V}$) or min. ($U_L - 1\text{ V}$) depending on the device variant max. 2 V	
Max. output current per device	0980 XSL 3912-121...	9 A (power supplied via U_L)
	0980 LSL 3x11-121...	4 A (power supplied via U_S)
	0980 LSL 3x10-121...	2 A (power supplied via U_S)

Max. output current per channel ⁶	0980 XSL 3912-121...	2 A (power supplied via U _S)
	0980 LSL 3x11-121...	0 A (no outputs on Ch. B)
	0980 LSL 3x10-121...	0 A (no outputs on Ch. B)
Short-circuit/overload protected	yes/yes	
Behavior in case of short circuit or overload	deactivation with automatic power-on (parameterized)	
Number of digital outputs	0980 XSL 3912-121...	8
	0980 LSL 3x11-121...	–
	0980 LSL 3x10-121...	–
Status indicator	white LED per output	
Diagnostic indicator	red LED per channel	

Table 81: I/O ports Ch. B (Pin 2) configured as digital outputs

⁶ For Class A devices: Max. 2.0 A per channel; for every port pair X1/X2, X3/X4, X5/X6, X7/X8 max. 6.5 A (for **UL applications** max. 5.0 A); for the whole port group X1 .. X8 max. 9.0 A in total (with derating).

14.7 LEDs

LED	Color	Description
U _L	Green	Auxiliary sensor/actuator voltage OK $18\text{ V } (+/- 1\text{ V}) < U_L < 30\text{ V } (+/- 1\text{ V})$
	Red*	Auxiliary sensor/actuator voltage LOW $U_L < 18\text{ V } (+/- 1\text{ V})$ or $U_L > 30\text{ V } (+/- 1\text{ V})$ * if "Report U _L supply voltage fault" is enabled.
	OFF	None of the above conditions.
U _S	Green	System/sensor voltage OK $18\text{ V } (+/- 1\text{ V}) < U_S < 30\text{ V } (+/- 1\text{ V})$
	Red	System/sensor voltage LOW $U_S < 18\text{ V } (+/- 1\text{ V})$ or $U_S > 30\text{ V } (+/- 1\text{ V})$
	Red flashing	Device performs a factory reset (position of rotary encoding switches: 9-7-9)
OFF	None of the above conditions.	
X1 .. X8 A	Green	IO-Link COM Mode: IO-Link communication exists.
	Green flashing	IO-Link COM Mode: No IO-Link communication.
	Yellow	Standard-I/O Mode: Status of digital input or output on C/Q (pin 4) line "on".
	OFF	None of the above conditions
X1 .. X8 B	White	Status of digital input or digital output on pin 2 line "on".
	Red	Short circuit on pin 4 and pin 2 line. / All modes: Overload or short circuit on L+ (pin 1) line / communication error
	OFF	None of the above conditions.
P1 Lnk/Act P2 Lnk/Act	Green	Ethernet connection to another subscriber exists. Link detected.
	Yellow flashing	Data exchange with another subscriber.
	OFF	No connection to another subscriber. No link, no data exchange.

LED	Color	Description
BF	Red	Bus fault. No configuration, no or slow physical connection.
	Red flashing at 2 Hz	Link exists but no communication link to the PROFINET controller.
	OFF	PROFINET controller has established an active connection to the device.
DIA	Red	PROFINET module diagnostic alarm active.
	Red flashing at 1 Hz	Watchdog time-out; fail safe mode is active.
	Red flashing at 2 Hz, 3 sec	DCP signal service is initiated via the bus.
	Red double flash	Firmware update
	OFF	None of the above conditions.
MS	Green	Device is ready for operation.
	Green flashing	Device is ready but not configured yet.
	Red	Serious error that cannot be resolved.
	Red flashing	Minor error that can be resolved Example: An incorrect or contradictory configuration is classified as a minor error.
	Flashing alternately:	The device is performing a self-test.
	Red Green	
	OFF	The device is switched off.

LED	Color	Description
NS	Green	Connected: The device has at least one connection.
	Green flashing	No connection: The device has no connection. IP address exists.
	Red	Duplicate IP address: The device has detected that the assigned IP address is already being used by another device.
	Red flashing	Connection has exceeded time limit or connection interrupted.
	Flashing alternately:	The device is performing a self-test.
	Red Green	
	OFF	The device is switched off or has not been assigned an IP address.

Table 82: Information on the LED colors

14.8 Data transfer times

The following tables give an overview of the internal data transfer times of the LioN-X IO-Link Master with a connected IO-Link Device as digital I/O extension (Belden article 0960 IOL 380-021 16DIO Hub with a minimum cycle time of 1 ms).

There are three measured data direction values for each use case:

- ▶ **PLC to DO:** Transfer of a changed PLC output data to IO-Link Device digital output.
- ▶ **DI to PLC:** Transfer of a changed digital input signal on IO-Link Device to PLC.
- ▶ **Round-trip time (RTT):** Transfer of a changed PLC output data to IO-Link Device digital output. The digital output is connected to an IO-Link Device digital input. Transfer of the changed digital input signal on IO-Link Device to PLC. $RTT = [PLC\ to\ DO] + [DI\ to\ PLC]$.

The measured values are taken from the ethernet data transmission line. The values are therefore without PLC processing times and PLC cycle time.

The configurable digital input filter value on 0960 IOL 380-021 was set to "off" (0 ms).

For calculation of user specific data transfer and round-trip times of possible input filters, PLC processing and cycles times must be taken into calculation.

The measured values are valid for a maximum of 48 bytes of IO-Link data for the IO-Link Master in each direction (Input/Output).

Use case 1:

IO-Link Master configuration with enabled Web interface and *disabled* IloT protocols

Data direction	Data transfer time in ms		
	Minimum	Average	Maximum
PLC to DO	3.7	6.0	7.7
DI to PLC	1.1	3.0	4.3
RTT	6.1	8.9	11.1

Use case 2:

IO-Link Master configuration with enabled Web interface and *enabled* IloT protocols

Data direction	Data transfer time in ms		
	Minimum	Average	Maximum
PLC to DO	7.7	10.0	13.4
DI to PLC	3.3	4.4	5.6
RTT	12.1	14.3	17.0

15 Accessories

In order to get access to various types of accessories, please visit our Web page:

<http://www.beldensolutions.com>