



HIRSCHMANN

A **BELDEN** BRAND

Hirschmann Automation and Control GmbH

GRS106 HiOS-2S Rel. 10000

Reference Manual

Graphical User Interface

User Manual

Configuration



HIRSCHMANN

A **BELDEN** BRAND

Reference Manual

Graphical User Interface

GREYHOUND Switch GRS105/106/115/116

HiOS-2S

The naming of copyrighted trademarks in this manual, even when not specially indicated, should not be taken to mean that these names may be considered as free in the sense of the trademark and tradename protection law and hence that they may be freely used by anyone.

© 2024 Hirschmann Automation and Control GmbH

Manuals and software are protected by copyright. All rights reserved. The copying, reproduction, translation, conversion into any electronic medium or machine scannable form is not permitted, either in whole or in part. An exception is the preparation of a backup copy of the software for your own use.

The performance features described here are binding only if they have been expressly agreed when the contract was made. This document was produced by Hirschmann Automation and Control GmbH according to the best of the company's knowledge. Hirschmann reserves the right to change the contents of this document without prior notice. Hirschmann can give no guarantee in respect of the correctness or accuracy of the information in this document.

Hirschmann can accept no responsibility for damages, resulting from the use of the network components or the associated operating software. In addition, we refer to the conditions of use specified in the license contract.

You find the latest user documentation for your device at: doc.hirschmann.com

Hirschmann Automation and Control GmbH
Stuttgarter Str. 45-51
72654 Neckartenzlingen
Germany

Contents

	Safety instructions	7
	About this Manual	9
	Key	10
	Notes on the Graphical User Interface	11
	Banner	11
	Menu pane	13
	Dialog area	15
1	Basic Settings	19
1.1	System	19
1.2	Network	24
1.2.1	Global	25
1.2.2	IPv4	27
1.2.3	IPv6	30
1.3	Software	33
1.4	Load/Save	37
1.5	External Memory	49
1.6	Port	52
1.7	Restart	59
2	Time	61
2.1	Basic Settings	61
2.2	SNTP	65
2.2.1	SNTP Client	66
2.2.2	SNTP Server	70
2.3	PTP	72
2.3.1	PTP Global	73
2.3.2	PTP Boundary Clock	75
2.3.2.1	PTP Boundary Clock Global	76
2.3.2.2	PTP Boundary Clock Port	81
2.3.3	PTP Transparent Clock	84
2.3.3.1	PTP Transparent Clock Global	85
2.3.3.2	PTP Transparent Clock Port	88
2.4	802.1AS	89
2.4.1	802.1AS Global	90
2.4.2	802.1AS Port	94
2.4.3	802.1AS Statistics	103
3	Device Security	105
3.1	User Management	105
3.2	Authentication List	111
3.3	Management Access	114
3.3.1	Server	115
3.3.2	IP Access Restriction	128

3.3.3	Web	132
3.3.4	Command Line Interface	133
3.3.5	SNMPv1/v2 Community	135
3.4	Pre-login Banner	136
3.5	SSH Known Hosts	137
4	Network Security	141
4.1	Network Security Overview	141
4.2	Port Security	143
4.3	802.1X	148
4.3.1	802.1X Global	149
4.3.2	802.1X Port Configuration	151
4.3.3	802.1X Port Clients	157
4.3.4	802.1X EAPOL Port Statistics	159
4.3.5	802.1X Port Authentication History	161
4.3.6	802.1X Integrated Authentication Server (IAS)	163
4.4	RADIUS	164
4.4.1	RADIUS Global	165
4.4.2	RADIUS Authentication Server	167
4.4.3	RADIUS Accounting Server	169
4.4.4	RADIUS Authentication Statistics	171
4.4.5	RADIUS Accounting Statistics	173
4.5	DoS	174
4.5.1	DoS Global	175
4.6	ACL	178
4.6.1	ACL IPv4 Rule	180
4.6.2	ACL MAC Rule	184
4.6.3	ACL Assignment	187
5	Switching	189
5.1	Switching Global	189
5.2	Rate Limiter	192
5.3	Filter for MAC Addresses	195
5.4	IGMP Snooping	197
5.4.1	IGMP Snooping Global	198
5.4.2	IGMP Snooping Configuration	200
5.4.3	IGMP Snooping Enhancements	204
5.4.4	IGMP Snooping Querier	207
5.4.5	IGMP Snooping Multicasts	210
5.5	MRP-IEEE	211
5.5.1	MRP-IEEE Configuration	212
5.5.2	MRP-IEEE Multiple MAC Registration Protocol	213
5.5.3	MRP-IEEE Multiple VLAN Registration Protocol	218
5.6	GARP	221
5.6.1	GVRP	222
5.7	QoS/Priority	223
5.7.1	QoS/Priority Global	224
5.7.2	QoS/Priority Port Configuration	225

5.7.3	802.1D/p Mapping	227
5.7.4	IP DSCP Mapping	228
5.7.5	Queue Management	230
5.8	VLAN	231
5.8.1	VLAN Global	233
5.8.2	VLAN Configuration	234
5.8.3	VLAN Port	237
5.8.4	VLAN Voice	239
5.9	L2-Redundancy	241
5.9.1	MRP	242
5.9.2	Spanning Tree	245
5.9.2.1	Spanning Tree Global	246
5.9.2.2	Spanning Tree Port	252
5.9.3	Link Aggregation	259
5.9.4	Link Backup	266
6	Diagnostics	271
6.1	Status Configuration	271
6.1.1	Device Status	272
6.1.2	Security Status	276
6.1.3	Signal Contact	283
6.1.3.1	Signal Contact 1 / Signal Contact 2	284
6.1.4	MAC Notification	288
6.1.5	Alarms (Traps)	290
6.1.5.1	Trap V3 User Management	291
6.1.5.2	Trap Destinations	294
6.2	System	296
6.2.1	System Information	297
6.2.2	Hardware State	298
6.2.3	Configuration Check	299
6.2.4	IP Address Conflict Detection	301
6.2.5	ARP	305
6.2.6	Selftest	307
6.3	Syslog	309
6.4	Ports	312
6.4.1	SFP	313
6.4.2	TP cable diagnosis	314
6.4.3	Port Monitor	316
6.4.4	Auto-Disable	327
6.4.5	Port Mirroring	331
6.5	LLDP	333
6.5.1	LLDP Configuration	334
6.5.2	LLDP Topology Discovery	338
6.6	Report	342
6.6.1	Report Global	343
6.6.2	Persistent Logging	347
6.6.3	System Log	350

6.6.4	Audit Trail	351
7	Advanced	353
7.1	DHCP	353
7.1.1	DHCP Server	353
7.1.1.1	DHCP Server Global	354
7.1.1.2	DHCP Server Pool	356
7.1.1.3	DHCP Server Lease Table	361
7.2	DHCP L2 Relay	362
7.2.1	DHCP L2 Relay Configuration	363
7.2.2	DHCP L2 Relay Statistics	366
7.3	Industrial Protocols	367
7.3.1	Modbus TCP	368
7.3.2	EtherNet/IP	370
7.3.3	PROFINET	372
7.4	Command Line Interface	375
A	Index	377
B	Technical support	383
C	Readers' Comments	384

Safety instructions

WARNING

UNCONTROLLED MACHINE ACTIONS

To avoid uncontrolled machine actions caused by data loss, configure all the data transmission devices individually.

Before you start any machine which is controlled via data transmission, be sure to complete the configuration of all data transmission devices.

Failure to follow these instructions can result in death, serious injury, or equipment damage.

About this Manual

The “Configuration” user manual contains the information you need to start operating the device. It takes you step by step from the first startup operation through to the basic settings for operation in your environment.

The “Installation” user manual contains a device description, safety instructions, a description of the display, and the other information that you need to install the device.

The “Graphical User Interface” reference manual contains detailed information on using the graphical user interface to operate the individual functions of the device.

The “Command Line Interface” reference manual contains detailed information on using the Command Line Interface to operate the individual functions of the device.

The Industrial HiVision Network Management software provides you with additional options for smooth configuration and monitoring:

- ▶ Auto-topology discovery
- ▶ Browser interface
- ▶ Client/server structure
- ▶ Event handling
- ▶ Event log
- ▶ Simultaneous configuration of multiple devices
- ▶ Graphical user interface with network layout
- ▶ SNMP/OPC gateway

Key

The designations used in this manual have the following meanings:

▶	List
□	Work step
Link	Cross-reference with link
Note:	A note emphasizes a significant fact or draws your attention to a dependency.
<code>Courier</code>	Representation of a CLI command or field contents in the graphical user interface

 Execution in the Graphical User Interface

 Execution in the Command Line Interface

Notes on the Graphical User Interface

The prerequisite to use the Graphical User Interface of the device is a web browser with HTML5 support.

The responsive Graphical User Interface automatically adapts to the size of your screen. Consequently, you can see more details on a large, high-resolution screen than on a small screen. For example, on a high-resolution screen, the buttons have a label next to the icon. On a screen with a small width, the Graphical User Interface displays only the icon.

Note: On a conventional screen, you click to navigate. On a device with a touchscreen, on the other hand, you tap. For simplicity, we only use "click" in our help texts.

The Graphical User Interface is divided as follows:

- [Banner](#)
- [Menu pane](#)
- [Dialog area](#)

Banner

The banner displays the following information:



Displays and hides the menu. When the web browser window is too narrow, the Graphical User Interface hides the menu pane. The banner displays the button instead.

Brand logo

Click the logo to open the website of the manufacturer of the device in a new window.

Dialog name

Displays the name of the dialog currently displayed in the dialog area.



Displays that the web browser cannot contact the device. The connection to the device is interrupted.



Displays if the settings in the volatile memory (*RAM*) differ from the settings of the "Selected" configuration profile in the non-volatile memory (*NVM*). The banner displays the icon if you have applied the settings, but not yet saved them in the non-volatile memory (*NVM*).



When you click the button, the online help opens in a new window.



When you click the button, a tooltip displays the following information:

- The summary of the *Device status* frame. See the *Basic Settings > System* dialog.
- The summary of the *Security status* frame. See the *Basic Settings > System* dialog.

A red dot next to the icon means that at least one of the values is greater than 0.



When you click the button, a submenu opens with the following menu items:

- User account name
The account name of the user that is currently logged in.
- *Logout* button
When you click the button, this logs out the currently logged in user. Then the login dialog opens.

Menu pane

When the web browser window is too narrow, the Graphical User Interface hides the menu pane.

To display the menu pane, click the  button in the banner.

The menu pane is divided as follows:

- [Icons bar](#)
- [Menu tree](#)

Icons bar

The icons bar displays the following information:

Device software

Displays the version number of the currently running device software that the device loaded during the last system startup.



Displays a text field to search for a keyword. When you enter a character or string, the menu tree displays a menu item only for those dialogs that are related to this keyword.



The menu tree displays a menu item only for those dialogs in which at least one parameter differs from the default setting (*Diff to default*). To display the complete menu tree again, click the  button.



Collapses the menu tree. The menu tree then displays only the menu items of the first level.



Expands the menu tree. The menu tree then displays every menu item on every level.

Menu tree

The menu tree contains one item for each dialog in the Graphical User Interface. When you click a menu item, the dialog area displays the corresponding dialog. You can change the view of the menu tree by clicking the buttons in the icons bar at the top. Furthermore, you can change the view of the menu tree by clicking the following buttons:



Expands the current menu item to display the menu items of the next lower level. The menu tree displays the button next to each collapsed menu item that contains menu items on the next lower level.



Collapses the menu item to hide the menu items of the lower levels. The menu tree displays the button next to each expanded menu item.

Dialog area

The dialog area displays the dialog that you select in the menu tree, including its controls. Here, you can monitor and change the settings of the device depending on your access role.

Below you find useful information on how to use the dialogs.

- [Control elements](#)
- [Modification mark](#)
- [Standard buttons](#)
- [Saving the settings](#)
- [Updating the display](#)
- [Working with tables](#)

Control elements

The dialogs contain different control elements. These control elements are read-only or editable, depending on the parameter and your access role as a user.

The control elements have the following visual properties:

- Input fields
 - An editable input field has a line at the bottom.
 - A read-only input field has no special visual properties.
- Checkboxes
 - An editable checkbox has a bright color.
 - A read-only checkbox has a grey color.
- Radio buttons
 - An editable radio button has a bright color.
 - A read-only radio button has a grey color.

Modification mark

When you modify a value, the corresponding field or table cell displays a red triangle in its top-left corner. The red triangle indicates that you have not yet applied this modification. The modified settings are not yet effective.

Standard buttons

Here you find the description of the standard buttons. The special dialog-specific buttons are described in the corresponding dialog help text.



Applies the settings you modified to the device.

Information on how the device retains the modified settings even after a reboot you find in section [“Saving the settings” on page 16](#).



Undoes the unsaved changes in the current dialog. Resets the values in the fields to the settings applied to the device.

Saving the settings

When applying settings, the device temporarily stores the modified settings. To do this, perform the following step:

- Click the button.

Note: Unintentional changes to the settings can terminate the connection between your PC and the device. To keep the device accessible, enable the *Undo configuration modifications* function in the *Basic Settings > Load/Save* dialog, before changing any settings. Using the function, the device continuously checks if it can still be reached from the IP address of your PC. If the connection is lost, then the device loads the configuration profile saved in the non-volatile memory (NVM) after the specified time. Afterwards, the device can be accessed again.

To keep the modified settings even after restarting the device, perform the following steps:

- Open the *Basic Settings > Load/Save* dialog.
- In the table, mark the checkbox far left in the table row of the desired configuration profile.
- When the checkbox in the *Selected* column is unmarked, click the button and then the *Select* item.
- Click the button to save your current changes.

Updating the display

If a dialog remains open for a longer time, then the values in the device have possibly changed in the meantime.

- To update the display in the dialog, click the button. Unsaved information in the dialog is lost.

Working with tables

The dialogs display numerous settings in table form. You have the option of customizing the appearance of the tables to fit your needs.

You can find useful information on how to use the tables in the following sections:

- [Filter rows](#)
- [Sort rows](#)
- [Select multiple table rows](#)

Filter rows

The filter lets you reduce the number of displayed table rows.



Displays a second table row in the table header containing a text field for every column. When you enter a string in a field, the table displays only the table rows that contain this string in the corresponding column.

Sort rows

You can change the order of the table rows. When you click the table header, an icon displays the sorting status.



Displays that the table rows are sorted by a criterion other than the values in this column.

Click the icon to sort the table rows in descending order based on the entries of the corresponding column. You might be able to restore the initial sorting in the table only after logging out and logging in again.



Displays that the table rows are sorted in descending order based on the entries of the corresponding column.

Click the icon to sort the table rows in ascending order based on the entries of the corresponding column. You might be able to restore the initial sorting in the table only after logging out and logging in again.



Displays that the table rows are sorted in ascending order based on the entries of the corresponding column.

Click the icon to sort the table rows in descending order based on the entries of the corresponding column. You might be able to restore the initial sorting in the table only after logging out and logging in again.

Select multiple table rows

You have the option of selecting multiple table rows at once and then apply an action to the selected table rows. This is useful for example, when you want to remove multiple table rows at the same time.

To select individual table rows, mark the leftmost checkbox in the desired table row.

To select every table row, mark the leftmost checkbox in the table header.

1 Basic Settings

The menu contains the following dialogs:

- ▶ System
- ▶ Network
- ▶ Software
- ▶ Load/Save
- ▶ External Memory
- ▶ Port
- ▶ Restart

1.1 System

[Basic Settings > System]

This dialog displays information about the operating status of the device.

Device status

Device status

Displays the device status and the alarms that currently exist. When at least one alarm is present, the background color changes to red. Otherwise, the background color remains green.

You specify the parameters that the device monitors in the [Diagnostics > Status Configuration > Device Status](#) dialog. If a monitored parameter differs from the desired status, then the device triggers an alarm.

A tooltip displays the cause of the currently existing alarms and the time at which the device triggered each alarm. To display the tooltip, hover the mouse pointer over or tap the field. In the [Diagnostics > Status Configuration > Device Status](#) dialog, the [Status](#) tab displays an overview of the alarms.

Note: If you connect only one power supply unit to a device that supports 2 redundant power supply units, then the device triggers an alarm. To avoid this alarm, deactivate the monitoring of the missing power supply units in the [Diagnostics > Status Configuration > Device Status](#) dialog.

Security status



Security status

Displays the security status and the alarms that currently exist. When at least one alarm is present, the background color changes to red. Otherwise, the background color remains green.

You specify the parameters that the device monitors in the [Diagnostics > Status Configuration > Security Status](#) dialog. If a monitored parameter differs from the desired status, then the device triggers an alarm.

A tooltip displays the cause of the currently existing alarms and the time at which the device triggered each alarm. To display the tooltip, hover the mouse pointer over or tap the field. In the [Diagnostics > Status Configuration > Security Status](#) dialog, the [Status](#) tab displays an overview of the alarms.

Signal contact status

The device can contain several signal contacts.



Signal contact status

Displays the signal contact status and the alarms that currently exist. When at least one alarm is present, the background color changes to red. Otherwise, the background color remains green.

You specify the parameters that the device monitors in the [Diagnostics > Status Configuration > Signal Contact > Signal Contact 1](#)/[Diagnostics > Status Configuration > Signal Contact > Signal Contact 2](#) dialog. If a monitored parameter differs from the desired status, then the device triggers an alarm.

A tooltip displays the cause of the currently existing alarms and the time at which the device triggered each alarm. To display the tooltip, hover the mouse pointer over or tap the field. In the [Diagnostics > Status Configuration > Signal Contact > Signal Contact 1](#)/[Diagnostics > Status Configuration > Signal Contact > Signal Contact 2](#) dialog, the [Status](#) tab displays an overview of the alarms.

System data

The fields in this frame display operating data and information on the location of the device.

System name

Specifies the name by which the device is known in the network.

Possible values:

► Alphanumeric ASCII character string with 0..255 characters

The device accepts the following characters:

- 0..9
- a..z
- A..Z
- !#\$%&'()*+,-./:;<=>?@[\\]^_`{|}~

<device type name>-<MAC address> (default setting)

When generating an digital certificate, the application generating the certificate uses the specified value as the domain name and common name.

The following functions use the specified value as a hostname or Fully Qualified Domain Name (FQDN). For compatibility reasons, it is recommended to use only lowercase letters, as some systems differentiate uppercase from lowercase in the FQDN. Verify that this name is unique in the entire network.

- DHCP client
- *Syslog*
- *PROFINET*

Note: Specify a device name that is compatible with PROFINET: max. 240 characters, not starting with a number. The participants in the network read the device name using SNMP and PROFINET DCP.

Location

Specifies the current or planned location.

Possible values:

- ▶ Alphanumeric ASCII character string with 0..255 characters

Contact person

Specifies the contact person for this device.

Possible values:

- ▶ Alphanumeric ASCII character string with 0..255 characters

Device type

Displays the product name of the device.

Power supply 1 Power supply 2

Displays the status of the power supply unit at the respective voltage supply connector.

Possible values:

- ▶ *present*
- ▶ *defective*
- ▶ *not installed*
- ▶ *unknown*

Uptime

Displays the time that has elapsed since the device was last restarted.

Possible values:

- ▶ Time in the format `day(s), ...h ...m ...s`

Temperature [°C]

Displays the current temperature in the device in °C.

You activate the monitoring of the temperature threshold values in the [Diagnostics > Status Configuration > Device Status](#) dialog.

Upper temp. limit [°C]

Specifies the upper temperature threshold value in °C.

Possible values:

- ▶ `-99..99` (integer)
If the temperature in the device exceeds the specified value, then the device displays an alarm.

Lower temp. limit [°C]

Specifies the lower temperature threshold value in °C.

Possible values:

- ▶ `-99..99` (integer)
If the temperature in the device falls below the specified value, then the device displays an alarm.

Humidity [%]

Displays the current humidity in the device as a percentage.

You activate the monitoring of the humidity threshold values in the [Diagnostics > Status Configuration > Device Status](#) dialog.

Upper humidity limit [%]

Specifies the upper humidity threshold value as a percentage.

Possible values:

- ▶ `0..100` (default setting: 95)
If the humidity in the device exceeds the specified value, then the device displays an alarm.

Lower humidity limit [%]

Specifies the lower humidity threshold value as a percentage.

Possible values:

- ▶ `0..100` (default setting: 5)
If the humidity in the device falls below the specified value, then the device displays an alarm.

LED status

For further information about the device status LEDs, see the “Installation” user manual.

Status



There is currently no device status alarm. The device status is OK.



There is currently at least one device status alarm. For details, see the [Device status](#) frame.

Power



Device that supports 2 redundant power supply units: Only one supply voltage is active.



Device that supports one power supply unit: The supply voltage is active.

Device that supports 2 redundant power supply units: Both supply voltages are active.

ACA



No external memory is connected.



The external memory is connected but not ready for operation.



The external memory is connected and ready for operation.

Port status

This frame displays a simplified view of the device ports at the time of the last display update. You identify the port status from the indicator.

In the initial view, the frame only displays ports with an active link. When you click the  button, the frame displays every port.

- The port speed is displayed next to the port number.
- When you hover the mouse pointer over or tap the appropriate port icon, a tooltip displays detailed port state information.

Green background color

Port with an active link.

Gray background color

Port with an inactive link.

Yellow background color

Port on which the device detected an unsupported SFP transceiver or an unsupported data rate.

Dashed border

Port in a *Blocking* state due to a redundancy function.

1.2 Network

[Basic Settings > Network]

The menu contains the following dialogs:

- ▶ Global
- ▶ IPv4
- ▶ IPv6

1.2.1 Global

[Basic Settings > Network > Global]

This dialog lets you specify the VLAN and HiDiscovery settings required for the access to the device management through the network.

Management interface

This frame lets you specify the VLAN in which the device management can be accessed.

VLAN ID

Specifies the VLAN in which the device management is accessible through the network. The device management is accessible through ports that are members of this VLAN.

Possible values:

- ▶ **1..4042** (default setting: 1)
The prerequisite is that in the [Switching > VLAN > Configuration](#) dialog the VLAN is already set up.

When you click the  button after changing the value, the [Information](#) window opens. Select the port, over which you connect to the device in the future. After clicking the [Ok](#) button, the new device management VLAN settings are assigned to the port.

- After that the port is a member of the VLAN and transmits the data packets without a VLAN tag (untagged). See the [Switching > VLAN > Configuration](#) dialog.
- The device assigns the port VLAN ID of the device management VLAN to the port. See the [Switching > VLAN > Port](#) dialog.

After a short time the device is reachable over the new port in the new device management VLAN.

MAC address

Displays the MAC address of the device. The device management is accessible through the network using the MAC address.

MAC address conflict detection

Enables/disables the [MAC address conflict detection](#) function.

Possible values:

- ▶ **marked**
The [MAC address conflict detection](#) function is enabled.
The device verifies that its MAC address is unique in the network.
- ▶ **unmarked** (default setting)
The [MAC address conflict detection](#) function is disabled.

HiDiscovery protocol v1/v2

This frame lets you specify settings for the access to the device using the HiDiscovery protocol.

On a PC, the HiDiscovery software displays the Hirschmann devices that can be accessed in the network on which the HiDiscovery function is enabled. You can access these devices even if they have invalid or no IP parameters assigned. The HiDiscovery software lets you assign or change the IP parameters in the device.

Note: With the HiDiscovery software you access the device only through ports that are members of the same VLAN as the device management. You specify which VLAN a certain port is assigned to in the [Switching > VLAN > Configuration](#) dialog.

Operation

Enables/disables the HiDiscovery function in the device.

Possible values:

- ▶ *On* (default setting)
The HiDiscovery function is enabled.
You can use the HiDiscovery software to access the device from your PC.
- ▶ *Off*
The HiDiscovery function is disabled.

Access

Enables/disables the write access to the device using for the HiDiscovery function.

Possible values:

- ▶ *readWrite* (default setting)
The HiDiscovery function has write access to the device. The device lets you change the IP parameters in the device using the HiDiscovery function.
- ▶ *readOnly*
The HiDiscovery function has read-only access to the device. The device lets you view the IP parameters in the device using the HiDiscovery function.

Recommendation: Change the setting to the value *readOnly* only after putting the device into operation.

Signal

Activates/deactivates the flashing of the port LEDs as does the function of the same name in the HiDiscovery software. The function lets you identify the device in the field.

Possible values:

- ▶ *marked*
The flashing of the port LEDs is active.
The port LEDs flash until you disable the function again.
- ▶ *unmarked* (default setting)
The flashing of the port LEDs is inactive.

1.2.2 IPv4

[Basic Settings > Network > IPv4]

This dialog allows you to specify the IPv4 settings required for the access to the device management through the network.

Management interface

IP address assignment

Specifies the source from which the device management receives its IP parameters.

Possible values:

- ▶ *Local*
The device uses the IP parameters from the internal memory. You specify the settings for this in the *IP parameter* frame.
- ▶ *BOOTP*
The device receives its IP parameters from a BOOTP or DHCP server.
The server evaluates the MAC address of the device, then assigns the IP parameters.
- ▶ *DHCP* (default setting)
The device receives its IP parameters from a DHCP server.
The server evaluates the MAC address, the DHCP name, or other parameters of the device, then assigns the IP parameters.

Note: If there is no response from the BOOTP or DHCP server, then the device sets the IP address to *0.0.0.0* and makes another attempt to obtain a valid IP address.

IP parameter

This frame lets you assign the IP parameters manually. If you have selected the *Local* radio button in the *Management interface* frame, *IP address assignment* option list, then these fields can be edited.

IP address

Specifies the IP address under which the device management can be accessed through the network.

Possible values:

- ▶ Valid IPv4 address

Netmask

Specifies the netmask.

Possible values:

- ▶ Valid IPv4 netmask

Gateway address

Specifies the IP address of a router through which the device accesses other devices outside of its own network.

Possible values:

- ▶ Valid IPv4 address

BOOTP/DHCP

Client ID

Displays the DHCP client ID that the device sends to the BOOTP or DHCP server. If the server is set up accordingly, then the server reserves an IP address for this DHCP client ID. Therefore, the device receives the same IP from the server every time it requests it.

The DHCP client ID that the device sends is the device name specified in the *System name* field in the *Basic Settings > System* dialog.

DHCP option 66/67/4/42

Enables/disables the *DHCP option 66/67/4/42* function in the device.

Possible values:

▶ *On* (default setting)

The *DHCP option 66/67/4/42* function is enabled.

The device loads the configuration profile and receives the time server information using the following DHCP options:

– Option 66: TFTP server name

Option 67: Boot file name

The device automatically loads the configuration profile from the DHCP server into the volatile memory (*RAM*) using the Trivial File Transfer Protocol (TFTP). The device uses the settings of the imported configuration profile in the *running-config*.

– Option 4: Time Server

Option 42: Network Time Protocol Servers

The device receives the time server information from the DHCP server.

▶ *Off*

The *DHCP option 66/67/4/42* function is disabled.

– The device does not load a configuration profile using DHCP Options 66/67.

– The device does not receive time server information using DHCP Options 4/42.

Remaining lease time

Lease time [s]

Displays the remaining time in seconds before the IP address, assigned to the device management by the DHCP server, expires.

To update the display, click the  button.

1.2.3 IPv6

[Basic Settings > Network > IPv6]

This dialog allows you to specify the IPv6 settings required for the access to the device management through the network.

Operation

Operation

Enables/disables the IPv6 protocol in the device.

You can operate IPv4 and IPv6 simultaneously in the device. This is possible with the use of the Dual IP Layer technique, also referred to as Dual Stack.

Possible values:

- ▶ *On* (default setting)
IPv6 is enabled.
- ▶ *Off*
IPv6 is disabled.
If you want the device to operate only using IPv4, then disable IPv6 in the device.

Configuration

Dynamic IP address assignment

Specifies the source from which the device management receives its IPv6 parameters.

Possible values:

- ▶ *None*
The device receives its IPv6 parameters manually.
You can manually specify a maximum number of 4 IPv6 addresses. You cannot specify loopback, link-local, and Multicast addresses as static IPv6 addresses.
- ▶ *Auto* (default setting)
The device receives its IPv6 parameters dynamically. The device receives a maximum of 2 IPv6 addresses.
An example here is the Router Advertisement Daemon (radvd). The radvd uses *Router Solicitation* and *Router Advertisement* messages to automatically set up an IPv6 address. The *Router Solicitation* and *Router Advertisement* messages are described in RFC 4861.
- ▶ *DHCPv6*
The device receives its IPv6 parameters from a DHCPv6 server.
- ▶ *ALL*
If the *All* radio button is selected, then the device receives its IPv6 parameters using every alternative for both dynamic and manual assignments.

DHCP

Client ID

Displays the DHCPv6 client ID that the device sends to the DHCPv6 server. If the server is set up accordingly, then the client device receives an IPv6 address for this DHCPv6 client ID.

The IPv6 address received from the DHCPv6 server has the *PrefixLength* value *128*. According to RFC 8415, a DHCPv6 server cannot currently be used to supply *Gateway address* or *PrefixLength* information.

The device can receive only one IPv6 address from the DHCPv6 server.

IP parameter

Gateway address

Specifies the IPv6 address of a router through which the device accesses other devices outside its own network.

Possible values:

- ▶ Valid IPv6 address (except loopback and Multicast addresses)

Note: If the *Auto* radio button is selected and you use a Router Advertisement Daemon (radvd), then the device automatically receives a link-local type *Gateway address* with a higher metric than the manually set *Gateway address*.

Duplicate Address Detection

In this field you can specify the number of consecutive *Neighbor Solicitation* messages that the device sends for the *Duplicate Address Detection* function. This function is used to determine the uniqueness of an IPv6 unicast address on the interface.

Number of neighbor solicitants

Specifies the number of *Neighbor Solicitation* messages that the device sends for the *Duplicate Address Detection* function.

Possible values:

- ▶ *0*
The function is disabled.
- ▶ *1..5* (default setting: *1*)

If the *Duplicate Address Detection* function discovers that an IPv6 address is not unique on a link, then the device does not log this event in the log file (System Log).

Table

This table displays a list of the IPv6 addresses set up for the device management.

For information on how to customize the appearance of the table, see [“Working with tables” on page 16](#).

Prefix

Displays the prefix of the IPv6 address in a compressed format. The prefix shows the leftmost bits of an IPv6 address, also known as the network part of the address.

PrefixLength

Displays the prefix length of the IPv6 address.

Unlike an IPv4 address, an IPv6 address does not use a subnet mask to identify the subnet part of the address. This role is performed in IPv6 by the prefix length.

Possible values:

- ▶ 0..128

IP address

Displays the full IPv6 address in a compressed format.

The compressed format is automatically applied to every IPv6 address, regardless of the source from which the device management receives its IPv6 parameters.

Possible values:

- ▶ Valid IPv6 address
To use an IPv6 address in a URL, use the following URL syntax: [https://\[<ipv6_address>\]](https://[<ipv6_address>]).

For further information on IPv6 compression rules and address types, see the “Configuration” user manual.

EUI option

Specifies if the *EUI option* function is applied to the IPv6 address.

When you mark this checkbox, the Interface ID of the IPv6 address is automatically specified. The device uses the MAC address of its interface with the values *ff* and *fe* added between byte 3 and byte 4 to generate a 64 bit Interface ID.

You can only select this option for IPv6 addresses that have a prefix length equal to 64.

Possible values:

- ▶ *marked*
The *EUI option* function is active.
- ▶ *unmarked* (default setting)
The *EUI option* function is inactive.

Origin

Specifies the way in which the device received its IPv6 parameters.

Possible values:

- ▶ *Autoconf*
The device received the IPv6 address dynamically, when the *Auto* radio button is selected.
- ▶ *Manual*
The device received the IPv6 address manually.
- ▶ *DHCP*
The device received the IPv6 address from a DHCPv6 server.
- ▶ *Linklayer*
The device automatically sets up a link-local type IPv6 address. The link-local address cannot be changed.

Status

Displays the current status of the IPv6 address.

Possible values:

- ▶ *active*
The IPv6 address is active.
- ▶ *notInService*
The IPv6 address is inactive.
- ▶ *notReady*
The IPv6 address is specified, but not currently active as some configuration parameters are still missing.

Note: When the IPv6 address is manually specified, you can manually change between *active* and *notInService* states. To do this, for the corresponding table row, select in the *Status* column the desired status from the drop-down list.

1.3 Software

[Basic Settings > Software]

This dialog lets you update the device software and display information about the device software.

You also have the option to restore a backup of the device software that is saved in the device.

Note: Before you update the device software, follow the version-specific notes in the [Readme](#) text file.

Version

Stored version

Displays the version number and creation date of the device software stored in the flash memory. The device loads the device software during the next system startup.

Running version

Displays the version number and creation date of the currently running device software that the device loaded during the last system startup.

Backup version

Displays the version number and creation date of the device software saved as a backup in the flash memory. The device copied this device software into the backup memory during the last software update or after you clicked the [Restore](#) button.

Restore

The device swaps the device software images and accordingly the values displayed in the fields [Stored version](#) and [Backup version](#).

During the next system startup, the device loads the device software displayed in the [Stored version](#) field.

Bootcode

Displays the version number and creation date of the boot code.

Software update

The device lets you update the device software at this place, if a suitable device software image is available outside the device. If a suitable device software image is saved on the selected external memory, use the table in the [File system](#) tab below.

URL

Specifies the path and the file name of the device software image that you use to update the device software.

The device gives you the following options for updating the device software:

- Software update from the PC
Drag and drop the file into the  area from your PC or network drive. As an alternative, click in the area to select the file.
- Software update from an FTP server
This option is not recommended if you transmit data over untrusted networks.
If the file is on an FTP server, then specify the URL in the following form:
`ftp://<user>:<password>@<IP address>[:port]/<file name>`
- Software update from a TFTP server
This option is not recommended if you transmit data over untrusted networks.
If the file is on a TFTP server, then specify the URL in the following form:
`tftp://<IP address>/<path>/<file name>`
- Software update from an SCP or SFTP server
If the file is on an SCP or SFTP server, then specify the URL in one of the following forms:
 - ▶ `scp://` or `sftp://<IP address>/<path>/<file name>`
Click the [Start](#) button to open the [Credentials](#) window. In this window, you enter the [User name](#) and [Password](#) to log into the server.
 - ▶ `scp://` or `sftp://<user>:<password>@<IP address>/<path>/<file name>`
Remember to set up the SCP or SFTP server as an SSH known host before the device accesses the server for the first time. See the [Device Security > SSH Known Hosts](#) dialog.

Start

Updates the device software.

- To remain logged in to the device management during the software update, move the mouse pointer occasionally. As an alternative, before you start the software update, specify a sufficiently high value in the [Device Security > Management Access > Web](#) dialog, [Web interface session timeout \[min\]](#) field.
- The device transfers the previously used device software to the backup memory.
- The device transfers the selected file to the flash memory, replacing the previously used device software. During the next startup, the device boots with the device software that you have transferred.

Allow upload of unsigned device software

Activates/deactivates the option that the device allows to upload an unsigned device software. The purpose of this setting is to enable the upload of a device software that does not have a cryptographic signature.

Possible values:

- ▶ [marked](#)
The device allows to upload an unsigned device software.
Uploading an unsigned device software can be a security risk. If you trust the originator, then you can upload the unsigned device software.
- ▶ [unmarked](#) (default setting)
The device only allows to upload a signed device software.

[File system]

Table

For information on how to customize the appearance of the table, see [“Working with tables” on page 16](#).

Buttons

Update Firmware

Updates the device software if a suitable device software image is saved on the external memory. The prerequisite is that a table row is selected for which the [File location](#) column displays the value [sd-card](#).

- To remain logged in to the device management during the software update, move the mouse pointer occasionally. As an alternative, before you start the software update, specify a sufficiently high value in the [Device Security > Management Access > Web](#) dialog, [Web interface session timeout \[min\]](#) field.
- The device transfers the previously used device software to the backup memory.
- The device transfers the selected file to the flash memory, replacing the previously used device software. During the next startup, the device boots with the device software that you have transferred.

File location

Displays the storage location of the device software.

Possible values:

- ▶ *ram*
Volatile memory of the device
- ▶ *flash*
Non-volatile memory (*NVM*) of the device
- ▶ *sd-card*
External SD memory (ACA31)

Index

Displays the index of the device software.

The index number of the device software in the flash memory has the following meaning:

- ▶ *1*
During the next system startup, the device loads this device software.
- ▶ *2*
The device copied this device software into the backup area during the last software update.

File name

Displays the device-internal file name of the device software.

Firmware

Displays the version number and creation date of the device software.

1.4 Load/Save

[Basic Settings > Load/Save]

This dialog lets you save the device settings permanently in a configuration profile.

The device can hold several configuration profiles. When you activate an alternative configuration profile, you change to other device settings. You have the option of exporting the configuration profiles to your PC or to a server. You also have the option of importing the configuration profiles from your PC or from a server to the device.

In the default setting, the device saves the configuration profiles unencrypted. If you enter a password in the [Configuration encryption](#) frame, then the device saves both the current and the future configuration profiles in an encrypted format.

Unintentional changes to the settings can terminate the connection between your PC and the device. To keep the device accessible, enable the [Undo configuration modifications](#) function before changing any settings. If the connection is lost, then the device loads the configuration profile saved in the non-volatile memory (*NVM*) after the specified time.

Note: Upgrading from Classic to HiOS? Convert your device configuration files using our online tool: <https://convert.hirschmann.com>

Table

For information on how to customize the appearance of the table, see [“Working with tables” on page 16](#).

Buttons

 Remove

Removes the configuration profile selected in the table from the non-volatile memory (*NVM*) or from the external memory.

If the configuration profile is designated as "Selected", then the device helps prevent you from removing the configuration profile.

 Save

Saves the temporarily applied settings in the configuration profile designated as "Selected" in the non-volatile memory (*NVM*).

When in the [Basic Settings > External Memory](#) dialog the checkbox in the [Backup config when saving](#) column is marked, then the device saves a copy of the configuration profile in the external memory.



Displays a context menu with further functions for the corresponding dialog.

Save as..

Opens the [Save as..](#) window to copy the configuration profile selected in the table and saves it with a user-specified name in the non-volatile memory (*NVM*).

- In the [Profile name](#) field, enter the name under which you want to save the configuration profile.
 - To save the configuration profile under a new name, click the **+** button.
 - To overwrite an existing configuration profile, select the corresponding item from the drop-down list.

If in the [Basic Settings > External Memory](#) dialog the checkbox in the [Backup config when saving](#) column is marked, then the device designates the configuration profile of the same name in the external memory as “Selected”.

Note: Before adding additional configuration profiles, decide for or against permanently activated configuration encryption in the device. Save additional configuration profiles either unencrypted or encrypted with the same password.

Activate

Loads the settings of the configuration profile selected in the table to the volatile memory (*RAM*).

- The device terminates the connection to the Graphical User Interface. To access the device management again, perform the following steps:
 - Reload the Graphical User Interface.
 - Log in again.
- The device immediately uses the settings of the configuration profile on the fly.

Enable the [Undo configuration modifications](#) function before you activate another configuration profile. If the connection is lost afterwards, then the device loads the last configuration profile designated as “Selected” from the non-volatile memory (*NVM*). The device can then be accessed again.

If the configuration encryption is inactive, then the device loads an unencrypted configuration profile. If the configuration encryption is active and the password matches the password stored in the device, then the device loads an encrypted configuration profile.

When you activate an older configuration profile, the device takes over the settings of the functions contained in this software version. The device sets the values of new functions to their default value.

Select

Designates the configuration profile selected in the table as “Selected”. In the [Selected](#) column, the checkbox is then [marked](#).

When applying the [Undo configuration modifications](#) function or during the system startup, the device loads the settings of this configuration profile to the volatile memory (*RAM*).

- If the configuration encryption in the device is disabled, then designate an unencrypted configuration profile only as “Selected”.
- If the configuration encryption in the device is enabled and the password of the configuration profile matches the password saved in the device, then designate an encrypted configuration profile only as “Selected”.

Otherwise, the device is unable to load and encrypt the settings in the configuration profile the next time it restarts. For this case you specify in the [Diagnostics > System > Selftest](#) dialog if the device starts with the default settings or terminates the restart and stops.

Note: You only mark the configuration profiles saved in the non-volatile memory (*NVM*).

If in the *Basic Settings > External Memory* dialog the checkbox in the *Backup config when saving* column is marked, then the device designates the configuration profile of the same name in the external memory as “Selected”.

Import...

Opens the *Import...* window to import a configuration profile.

The prerequisite is that you have exported the configuration profile using the *Export...* button or using the link in the *Profile name* column.

- From the *Select source* drop-down list, select from where the device imports the configuration profile.
 - ▶ *PC/URL*
The device imports the configuration profile from the local PC or from a remote server.
 - ▶ *External memory*
The device imports the configuration profile from the external memory.
- When *PC/URL* is selected above, in the *Import profile from PC/URL* frame you specify the configuration profile file to be imported.
 - Import from the PC
If the file is on your PC or on a network drive, then drag and drop the file into the  area. As an alternative, click in the area to select the file.
 - Import from an FTP server
This option is not recommended if you transmit data over untrusted networks. If the file is on an FTP server, then specify the URL in the following form:
ftp://<user>:<password>@<IP address>[:port]/<file name>
 - Import from a TFTP server
This option is not recommended if you transmit data over untrusted networks. If the file is on a TFTP server, then specify the URL in the following form:
tftp://<IP address>/<path>/<file name>
 - Import from an SCP or SFTP server
If the file is on an SCP or SFTP server, then specify the URL in one of the following forms:
scp:// or sftp://<IP address>/<path>/<file name>
Click the *Start* button to open the *Credentials* window. In this window, you enter the *User name* and *Password* to log into the server.
scp:// or sftp://<user>:<password>@<IP address>/<path>/<file name>
Remember to set up the SCP or SFTP server as an SSH known host before the device accesses the server for the first time. See the *Device Security > SSH Known Hosts* dialog.
- When *External memory* is selected above, in the *Import profile from external memory* frame you specify the configuration profile file to be imported.
From the *Profile name* drop-down list, select the name of the configuration profile to be imported.
- In the *Destination* frame you specify where the device saves the imported configuration profile. In the *Profile name* field you specify the name under which the device saves the configuration profile.
In the *Storage* field you specify the storage location for the configuration profile. The prerequisite is that from the *Select source* drop-down list the *PC/URL* item is selected.
 - ▶ *RAM*
The device saves the configuration profile in the volatile memory (*RAM*) of the device. This replaces the *running-config*, the device uses the settings of the imported configuration profile immediately. The device terminates the connection to the Graphical User Interface. Reload the Graphical User Interface. Log in again.
 - ▶ *NVM*
The device saves the configuration profile in the non-volatile memory (*NVM*) of the device.

When you import a configuration profile, the device takes over the settings as follows:

- If the configuration profile was exported on the same device or on an identically equipped device of the same type, then:
The device takes over the settings completely.
- If the configuration profile was exported on another device, then:
The device takes over the settings which it can interpret based on its hardware equipment and software level.
The remaining settings the device takes over from its [running-config](#) configuration profile.

Regarding configuration profile encryption, also read the help text of the [Configuration encryption](#) frame. The device imports a configuration profile under the following conditions:

- The configuration encryption of the device is inactive. The configuration profile is unencrypted.
- The configuration encryption of the device is active. The configuration profile is encrypted with the same password that the device currently uses.

Export...

Exports the configuration profile selected in the table and saves it as an XML file on a remote server.

To save the file on your PC, click the link in the [Profile name](#) column to select the storage location and specify the file name.

The device gives you the following options for exporting a configuration profile:

- Export to an FTP server
This option is not recommended if you transmit data over untrusted networks.
To save the file on an FTP server, specify the URL for the file in the following form:
`ftp://<user>:<password>@<IP address>[:port]/<file name>`
- Export to a TFTP server
This option is not recommended if you transmit data over untrusted networks.
To save the file on a TFTP server, specify the URL for the file in the following form:
`tftp://<IP address>/<path>/<file name>`
- Export to an SCP or SFTP server
To save the file on an SCP or SFTP server, specify the URL for the file in one of the following forms:
 - ▶ `scp://` or `sftp://<IP address>/<path>/<file name>`
Click the [Ok](#) button to open the [Credentials](#) window. In this window, you enter the [User name](#) and [Password](#) to log into the server.
 - ▶ `scp://` or `sftp://<user>:<password>@<IP address>/<path>/<file name>`
Remember to set up the SCP or SFTP server as an SSH known host before the device accesses the server for the first time. See the [Device Security > SSH Known Hosts](#) dialog.

Save running-config as script

Saves the [running config](#) configuration profile as a script file on the local PC. This lets you backup your current device settings or to use them on various devices.

Load running-config from script

Imports a script file which modifies the current **running config** configuration profile.

The device gives you the following options to import a script file:

- Import from the PC

If the file is on your PC or on a network drive, then drag and drop the file into the  area. As an alternative, click in the area to select the file.

- Import from an FTP server

This option is not recommended if you transmit data over untrusted networks.

If the file is on an FTP server, then specify the URL in the following form:

`ftp://<user>:<password>@<IP address>[:port]/<file name>`

- Import from a TFTP server

This option is not recommended if you transmit data over untrusted networks.

If the file is on a TFTP server, then specify the URL in the following form:

`tftp://<IP address>/<path>/<file name>`

- Import from an SCP or SFTP server

If the file is on an SCP or SFTP server, then specify the URL in one of the following forms:

`scp://` or `sftp://<IP address>/<path>/<file name>`

Remember to set up the SCP or SFTP server as an SSH known host before the device accesses the server for the first time. See the [Device Security > SSH Known Hosts](#) dialog.

Back to factory...

Resets the settings in the device to the default values.

- The device deletes the saved configuration profiles from the volatile memory (**RAM**) and from the non-volatile memory (**NVM**).
- The device deletes the digital certificate used by the web server in the device.
- The device deletes the RSA key (Host Key) used by the SSH server in the device.
- When an external memory is connected, the device deletes the configuration profiles saved in the external memory.
- After a short time, the device reboots and then uses the default settings.

Back to default

Deletes the current operating (**running config**) settings from the volatile memory (**RAM**).

Storage

Displays the storage location of the configuration profile.

Possible values:

- ▶ **RAM** (volatile memory of the device)

In the volatile memory, the device stores the settings for the current operation.

- ▶ **NVM** (non-volatile memory of the device)
When applying the [Undo configuration modifications](#) function or during the system startup, the device loads the “Selected” configuration profile from the non-volatile memory.
The non-volatile memory provides space for multiple configuration profiles, depending on the number of settings saved in the configuration profile. The device manages a maximum of 20 configuration profiles in the non-volatile memory.
You can load a configuration profile into the volatile memory (*RAM*). To do this, perform the following steps:
 - Select the table row of the configuration profile.
 - Click the  button and then the [Activate](#) item.
- ▶ **ENVM** (external memory)
In the external memory, the device saves a backup copy of the “Selected” configuration profile. The prerequisite is that in the [Basic Settings > External Memory](#) dialog the [Backup config when saving](#) checkbox is marked.

Profile name

Displays the name of the configuration profile.

Possible values:

- ▶ [running-config](#)
Name of the configuration profile in the volatile memory (*RAM*).
- ▶ [config](#)
Name of the factory setting configuration profile in the non-volatile memory (*NVM*).
- ▶ User-defined name
The device lets you save a configuration profile with a user-specified name. To do this, select the table row of an existing configuration profile in the table, click the  button and then the [Save as..](#) item.

To export the configuration profile as an XML file on your PC, click the link. Then you select the storage location and specify the file name.

To save the file on a remote server, click the  button and then the [Export...](#) item.

Last modified (UTC)

Displays the Universal Time Coordinated (UTC) time a user last saved the configuration profile.

Selected

Displays if the configuration profile is designated as “Selected”.

The device lets you designate another configuration profile as “Selected”. To do this, select the desired configuration profile in the table, click the  button and then the [Activate](#) item.

Possible values:

▶ **marked**

The configuration profile is designated as “Selected”.

- When applying the [Undo configuration modifications](#) function or during the system startup, the device loads the configuration profile into the volatile memory (*RAM*).
- When you click the  button, the device saves the temporarily applied settings in this configuration profile.

▶ **unmarked**

Another configuration profile is designated as “Selected”.

Encryption

Displays if the configuration profile is encrypted.

Possible values:

▶ **marked**

The configuration profile is encrypted.

▶ **unmarked**

The configuration profile is unencrypted.

You activate/deactivate the encryption of the configuration profile in the [Configuration encryption](#) frame.

Verified

Displays if the password of the encrypted configuration profile matches the password stored in the device.

Possible values:

▶ **marked**

The passwords match. The device is able to unencrypt the configuration profile.

▶ **unmarked**

The passwords are different. The device is unable to unencrypt the configuration profile.

Note: The device applies script files additionally to the current settings. Verify that the script file does not contain any parts that conflict with the current settings.

Software version

Displays the version number of the device software that the device ran while saving the configuration profile.

Fingerprint

Displays the checksum saved in the configuration profile.

When saving the settings, the device calculates the checksum and inserts it into the configuration profile.

Verified

Displays if the checksum saved in the configuration profile is valid.

The device calculates the checksum of the configuration profile marked as “Selected” and compares it with the checksum saved in this configuration profile.

Possible values:

- ▶ *marked*
The calculated and the saved checksum match.
The saved settings are consistent.
- ▶ *unmarked*
For the configuration profile marked as “Selected” applies:
The calculated and the saved checksum are different.
The configuration profile contains modified settings.
Possible causes:
 - The file is damaged.
 - The file system in the external memory is inconsistent.
 - A user has exported the configuration profile and changed the XML file outside the device.For the other configuration profiles the device has not calculated the checksum.

The device verifies the checksum correctly only if the configuration profile has been saved before as follows:

- on an identical device
- with the same software version, which the device is running
- with a lower or the same level of the device software such as HiOS-2A or HiOS-3S on a device which runs HiOS-3S

Note: This function identifies changes to the settings in the configuration profile. The function does not provide protection against operating the device with modified settings.

External memory

Selected external memory

Displays the type of the external memory.

Possible values:

- ▶ *sd*
External SD memory (ACA31)

Status

Displays the operating state of the external memory.

Possible values:

- ▶ *notPresent*
No external memory is connected.
- ▶ *removed*
Someone has removed the external memory from the device during operation.
- ▶ *ok*
The external memory is connected and ready for operation.
- ▶ *outOfMemory*
The memory space is occupied in the external memory.
- ▶ *genericErr*
The device has detected an error.

Configuration encryption

Active

Displays if the configuration encryption is active/inactive in the device.

Possible values:

▶ **marked**

The configuration encryption is active.

If the configuration profile is encrypted and the password matches the password stored in the device, then the device loads a configuration profile from the non-volatile memory (*NVM*).

▶ **unmarked**

The configuration encryption is inactive.

If the configuration profile is unencrypted, then the device loads a configuration profile from the non-volatile memory (*NVM*) only.

If in the *Basic Settings > External Memory* dialog, the *Config priority* column has the value *first* and the configuration profile is unencrypted, then the *Security status* frame in the *Basic Settings > System* dialog displays an alarm.

In the *Diagnostics > Status Configuration > Security Status* dialog, *Global* tab, *Monitor* column you specify if the device monitors the *Load unencrypted config from external memory* parameter.

Set password

Opens the *Set password* window that helps you to enter the password needed for the configuration profile encryption. Encrypting the configuration profiles makes unauthorized access more difficult. To do this, perform the following steps:

- When you are changing an existing password, enter the existing password in the *Old password* field. To display the password in plain text instead of ***** (asterisks), mark the *Display content* checkbox.
- In the *New password* field, enter the password. To display the password in plain text instead of ***** (asterisks), mark the *Display content* checkbox.
- Mark the *Save configuration afterwards* checkbox to use encryption also for the “Selected” configuration profile in the non-volatile memory (*NVM*) and in the external memory.

Note: If a maximum of one configuration profile is stored in the non-volatile memory (*NVM*) of the device, then use this function only. Before adding additional configuration profiles, decide for or against permanently activated configuration encryption in the device. Save additional configuration profiles either unencrypted or encrypted with the same password.

If you are replacing a device with an encrypted configuration profile, for example due to an inoperable device, then perform the following steps:

- Restart the new device and assign the IP parameters.
- Open the *Basic Settings > Load/Save* dialog on the new device.
- Encrypt the configuration profile in the new device. See above. Enter the same password you used in the inoperable device.
- Install the external memory from the inoperable device in the new device.
- Restart the new device.
During the next system startup, the device loads the configuration profile with the settings of the inoperable device from the external memory. The device copies the settings into the volatile memory (*RAM*) and into the non-volatile memory (*NVM*).

Delete

Opens the *Delete* window which helps you to cancel the configuration encryption in the device. To cancel the configuration encryption, perform the following steps:

- In the *Old password* field, enter the existing password.
To display the password in plain text instead of ***** (asterisks), mark the *Display content* checkbox.
- Mark the *Save configuration afterwards* checkbox to remove the encryption also for the “Selected” configuration profile in the non-volatile memory (*NVM*) and in the external memory.

Note: If you keep additional encrypted configuration profiles in the memory, then the device helps prevent you from activating or designating these configuration profiles as “Selected”.

Undo configuration modifications

Operation

Enables/disables the *Undo configuration modifications* function. Using the function, the device continuously checks if it can still be reached from the IP address of your PC. If the connection is lost, after a specified time period the device loads the “Selected” configuration profile from the non-volatile memory (*NVM*). Afterwards, the device can be accessed again.

Possible values:

- ▶ *On*
The function is enabled.
 - You specify the time period between the interruption of the connection and the loading of the configuration profile in the *Timeout [s] to recover after connection loss* field.
 - When the non-volatile memory (*NVM*) contains multiple configuration profiles, the device loads the configuration profile designated as “Selected”.
- ▶ *Off* (default setting)
The function is disabled.
Disable the function again before you close the Graphical User Interface. You thus help prevent the device from restoring the configuration profile designated as “Selected”.

Note: Before you enable the function, save the settings in the configuration profile. The device thus maintains the current settings, that are only temporarily saved.

Timeout [s] to recover after connection loss

Specifies the time in seconds after which the device loads the “Selected” configuration profile from the non-volatile memory (*NVM*) if the connection is lost.

Possible values:

- ▶ *30..600* (default setting: *600*)

Specify a sufficiently large value. Take into account the time when you are viewing the dialogs of the Graphical User Interface without changing or updating them.

Watchdog IP address

Displays the IP address of the PC on which you have enabled the function.

Possible values:

- ▶ IPv4 address (default setting: 0.0.0.0)

Information

NVM in sync with running config

Displays if the settings in the volatile memory (*RAM*) differ from the settings of the "Selected" configuration profile in the non-volatile memory (*NVM*).

Possible values:

- ▶ *marked*
The settings match.
- ▶ *unmarked*

The settings differ. Additionally, the Banner displays the icon !

External memory in sync with NVM

Displays if the settings of the "Selected" configuration profile in the external memory (*ACA*) differ from the settings of the "Selected" configuration profile in the non-volatile memory (*NVM*).

Possible values:

- ▶ *marked*
The settings match.
- ▶ *unmarked*
The settings differ.

Possible causes:

- No external memory is connected to the device.
- In the [Basic Settings > External Memory](#) dialog, the [Backup config when saving](#) function is disabled.

Backup config on a remote server when saving

Operation

Enables/disables the [Backup config on a remote server when saving](#) function.

Possible values:

- ▶ *Enabled*
The [Backup config on a remote server when saving](#) function is enabled.
When you save the configuration profile in the non-volatile memory (*NVM*), the device automatically backs up the configuration profile on the remote server specified in the [URL](#) field.
- ▶ *Disabled* (default setting)
The [Backup config on a remote server when saving](#) function is disabled.

URL

Specifies path and file name of the backed up configuration profile on the remote server.

Possible values:

- ▶ Alphanumeric ASCII character string with 0..128 characters
Example: tftp://192.9.200.1/cfg/config.xml
The device supports the following wildcards:
 - %d
System date in the format YYYY-mm-dd
 - %t
System time in the format HH_MM_SS
 - %i
IP address of the device
 - %m
MAC address of the device in the format AA-BB-CC-DD-EE-FF
 - %p
Product name of the device

Set credentials

Opens the *Credentials* window which helps you to enter the login credentials needed to authenticate on the remote server. To do this, perform the following steps:

- In the *User name* field, enter the user name.
To display the user name in plain text instead of ***** (asterisks), mark the *Display content* checkbox.
Possible values:
 - ▶ Alphanumeric ASCII character string with 1..32 characters
- In the *Password* field, enter the password.
To display the password in plain text instead of ***** (asterisks), mark the *Display content* checkbox.
Possible values:
 - ▶ Alphanumeric ASCII character string with 6..64 characters
The device accepts the following characters:
a..z
A..Z
0..9
!#\$%&'()*+,-./:;<=>?@[\\]^_`{|}~

1.5 External Memory

[Basic Settings > External Memory]

This dialog lets you activate functions that the device automatically executes in combination with the external memory. The dialog also displays the operating state and identifying characteristics of the external memory.

Table

For information on how to customize the appearance of the table, see [“Working with tables” on page 16](#).

Type

Displays the type of the external memory.

Possible values:

- ▶ *sd*
External SD memory (ACA31)

Status

Displays the operating state of the external memory.

Possible values:

- ▶ *notPresent*
No external memory is connected.
- ▶ *removed*
Someone has removed the external memory from the device during operation.
- ▶ *ok*
The external memory is connected and ready for operation.
- ▶ *outOfMemory*
The memory space is occupied in the external memory.
- ▶ *genericErr*
The device has detected an error.

Writable

Displays if the device has write access to the external memory.

Possible values:

- ▶ *marked*
The device has write access to the external memory.
- ▶ *unmarked*
The device has read-only access to the external memory. Possibly the write protection is activated in the external memory.

Software auto update

Activates/deactivates the automatic device software update during the system startup.

Possible values:

- ▶ **marked** (default setting)
The device updates the device software when the following files are located in the external memory:
 - the device software image file
 - a text file startup.txt with the content `autoUpdate=<software_image_file_name>.bin`
- ▶ **unmarked**
No automatic device software update during the system startup.

SSH key auto upload

Activates/deactivates the loading of the RSA key from an external memory during the system startup.

Possible values:

- ▶ **marked** (default setting)
The loading of the RSA key is activated.
During the system startup, the device loads the RSA key from the external memory when the following files are located in the external memory:
 - SSH RSA key file
 - a text file startup.txt with the content `autoUpdateRSA=<filename_of_the_SSH_RSA_key>`The device displays messages on the system console of the serial interface.
- ▶ **unmarked**
The loading of the RSA key is deactivated.

Note: When loading the RSA key from the external memory (*ENVM*), the device overwrites the existing keys in the non-volatile memory (*NVM*).

Config priority

Specifies the memory from which the device loads the configuration profile upon reboot.

Possible values:

- ▶ **disable**
The device loads the configuration profile from the non-volatile memory (*NVM*).
- ▶ **first**
The device loads the configuration profile from the external memory.
When the device does not find a configuration profile in the external memory, it loads the configuration profile from the non-volatile memory (*NVM*).

Note: When loading the configuration profile from the external memory (*ENVM*), the device overwrites the settings of the “Selected” configuration profile in the non-volatile memory (*NVM*).

If the *Config priority* column has the value *first* and the configuration profile is unencrypted, then the *Security status* frame in the *Basic Settings > System* dialog displays an alarm.

In the *Diagnostics > Status Configuration > Security Status* dialog, *Global* tab, *Monitor* column you specify if the device monitors the *Load unencrypted config from external memory* parameter.

Backup config when saving

Activates/deactivates saving a copy of the configuration profile in the external memory.

Possible values:

- ▶ **marked** (default setting)

Saving a copy is activated. When you click in the [Basic Settings > Load/Save](#) dialog the  button, the device saves a copy of the configuration profile on the active external memory.

- ▶ **unmarked**

Saving a copy is deactivated. The device does not save a copy of the configuration profile.

Manufacturer ID

Displays the name of the memory manufacturer.

Revision

Displays the revision number specified by the memory manufacturer.

Version

Displays the version number specified by the memory manufacturer.

Name

Displays the product name specified by the memory manufacturer.

Serial number

Displays the serial number specified by the memory manufacturer.

1.6 Port

[Basic Settings > Port]

This dialog lets you specify settings for the individual ports. The dialog also displays the operating mode, connection status, bit rate and duplex mode for every port.

The dialog contains the following tabs:

- ▶ [Configuration]
- ▶ [Statistics]
- ▶ [Ingress Utilization]

[Configuration]

Table

For information on how to customize the appearance of the table, see [“Working with tables” on page 16](#).

Port

Displays the port number.

Name

Name of the port.

Possible values:

- ▶ Alphanumeric ASCII character string with 0..64 characters
The device accepts the following characters:
 - <space>
 - 0..9
 - a..z
 - A..Z
 - !#\$%&'()*+,-./:;<=>@[\\]^_`{|}~

Port on

Activates/deactivates the port.

Possible values:

- ▶ **marked** (default setting)
The port is active.
- ▶ **unmarked**
The port is inactive. The port does not send or receive any data.

State

Displays if the port is currently physically enabled or disabled.

Possible values:

- ▶ [marked](#)
The port is physically enabled.
- ▶ [unmarked](#)
The port is physically disabled.
When the [Port on](#) function is active, the [Auto-Disable](#) function has disabled the port. You specify the settings of the [Auto-Disable](#) function in the [Diagnostics > Ports > Auto-Disable](#) dialog.

Autoneg

Activates/deactivates the automatic selection of the operating mode for the port.

Possible values:

- ▶ [marked](#) (default setting for twisted-pair ports)
The automatic selection of the operating mode is active.
The port negotiates the operating mode independently using auto-negotiation and automatically detects the assignment of the twisted-pair port connectors (auto cable crossing). This setting has priority over the manual setting of the port.
Elapse several seconds until the port has set the operating mode.
- ▶ [unmarked](#)
The automatic selection of the operating mode is inactive.
The port operates with the values you specify in the [Manual configuration](#) column and in the [Manual cable crossing](#) column.
- ▶ Grayed-out display (default setting for optical ports with port speeds > 1G)
No automatic selection of the operating mode.

Manual configuration

Specifies the operating mode of the ports when the [Autoneg](#) function is disabled.

Possible values:

- ▶ [10M HDX](#)
Half-duplex connection
- ▶ [10M FDX](#)
Full-duplex connection
- ▶ [100M HDX](#)
Half-duplex connection
- ▶ [100M FDX](#)
Full-duplex connection
- ▶ [1G FDX](#)
Full-duplex connection
- ▶ [2.5G FDX](#)
Full-duplex connection
- ▶ [10G FDX](#)
Full-duplex connection

Note: The operating modes of the port actually available depend on the device hardware.

Link/Current settings

Displays the operating mode which the port currently uses.

Possible values:

- ▶ `-`
No cable connected, no link.
- ▶ `10M HDX`
Half-duplex connection
- ▶ `10M FDX`
Full-duplex connection
- ▶ `100M HDX`
Half-duplex connection
- ▶ `100M FDX`
Full-duplex connection
- ▶ `1G FDX`
Full-duplex connection
- ▶ `2.5G FDX`
Full-duplex connection
- ▶ `10G FDX`
Full-duplex connection

Note: The operating modes of the port actually available depend on the device hardware.

Manual cable crossing

Specifies the devices connected to a twisted-pair port.

The prerequisite is that the [Autoneg](#) function is disabled.

Possible values:

- ▶ `mdi`
The device interchanges the send- and receive-line pairs on the port.
- ▶ `mdix` (default setting on twisted-pair ports)
The device helps prevent the interchange of the send- and receive-line pairs on the port.
- ▶ `auto-mdix`
The device detects the send and receive line pairs of the connected device and automatically adapts to them.
Example: When you connect an end device with a crossed cable, the device automatically resets the port from `mdix` to `mdi`.
- ▶ `unsupported` (default setting on optical ports or twisted-pair SFP ports)
The port does not support this function.

Flow control

Activates/deactivates the flow control on the port.

Possible values:

- ▶ **marked** (default setting)
The Flow control on the port is active.
The sending and evaluating of pause packets (full-duplex operation) or collisions (half-duplex operation) is activated on the port.
 - To enable the flow control in the device, also activate the *Flow control* function in the *Switching > Global* dialog.
 - Activate the flow control also on the port of the device that is connected to this port.
On an uplink port, activating the flow control can possibly cause undesired sending interruptions in the higher-level network segment (“wandering backpressure”).
- ▶ **unmarked**
The Flow control on the port is inactive.

If you are using a redundancy function, then you deactivate the flow control on the participating ports. If the flow control and the redundancy function are active at the same time, it is possible that the redundancy function operates differently than intended.

Send trap

Activates/deactivates the sending of SNMP traps when the device detects a change in the link up/down status on the port.

Possible values:

- ▶ **marked** (default setting)
The sending of SNMP traps is active. The prerequisite is that in the *Diagnostics > Status Configuration > Alarms (Traps)* dialog the *Alarms (Traps)* function is enabled and at least one trap destination is specified.
When the device detects a link up/down status change, the device sends an SNMP trap.
- ▶ **unmarked**
The sending of SNMP traps is inactive.

MTU

Specifies the maximum allowed size of Ethernet packets on the port in bytes.

Possible values:

- ▶ **1518..12288** (default setting: **1518**)
With the setting **1518**, the port transmits the Ethernet packets up to the following size:
 - 1518 bytes without VLAN tag
(1514 bytes + 4 bytes CRC)
 - 1522 bytes with VLAN tag
(1518 bytes + 4 bytes CRC)

Note: Depending on the device hardware, some ports support a maximum value of **10240**.

This setting lets you increase the max. allowed size of Ethernet packets that this port can receive or transmit.

The following list contains possible applications:

- When you use the device in the transfer network with double VLAN tagging, it is possible that you require an *MTU* that is larger by 4 bytes.

On other interfaces, you specify the maximum permissible size of the Ethernet packets as follows:

- *Link Aggregation* interfaces
Switching > L2-Redundancy > Link Aggregation dialog, *MTU* column

Power state

Specifies if the port is physically switched on or off when you deactivate the port with the *Port on* function.

Possible values:

- ▶ *marked*
The port remains physically enabled. A connected device receives an active link.
- ▶ *unmarked* (default setting)
The port is physically disabled.

Power save

Specifies how the port behaves when no cable is connected.

Possible values:

- ▶ *no-power-save* (default setting)
The port remains activated.
- ▶ *auto-power-down*
The port changes to the energy-saving mode.
- ▶ *unsupported*
The port does not support this function and remains activated.

Signal

Activates/deactivates the port LED flashing. This function lets you identify the port in the field.

Possible values:

- ▶ *marked*
The flashing of the port LED is active.
The port LED flashes until you disable the function again.
- ▶ *unmarked* (default setting)
The flashing of the port LED is inactive.

[Statistics]

This tab displays the following overview per port:

- Number of data packets/bytes received by the device
 - *Received packets*
 - *Received octets*
 - *Received unicasts*
 - *Received multicasts*
 - *Received broadcasts*

- Number of data packets/bytes sent or forwarded by the device
 - [Transmitted packets](#)
 - [Transmitted octets](#)
 - [Transmitted unicasts](#)
 - [Transmitted multicasts](#)
 - [Transmitted broadcasts](#)
- Number of errors detected by the device
 - [Received fragments](#)
 - [Detected CRC errors](#)
 - [Detected collisions](#)
- Number of data packets per size category received by the device
 - [Packets 64 bytes](#)
 - [Packets 65 to 127 bytes](#)
 - [Packets 128 to 255 bytes](#)
 - [Packets 256 to 511 bytes](#)
 - [Packets 512 to 1023 bytes](#)
 - [Packets 1024 to 1518 bytes](#)
- Number of data packets discarded by the device
 - [Received discards](#)
 - [Transmitted discards](#)

To sort the table by a specific criterion click the header of the corresponding column.

For example, to sort the table based on the number of received bytes in ascending order, click the header of the [Received octets](#) column once. To sort in descending order, click the header again.

To reset the counter for the port statistics in the table to 0, perform the following steps:

- In the [Basic Settings > Port](#) dialog, click the  button.
- or
- In the [Basic Settings > Restart](#) dialog, click the [Clear port statistics](#) button.

[Ingress Utilization]

This tab displays the ingress network load on the individual ports.

Table

For information on how to customize the appearance of the table, see [“Working with tables” on page 16](#).

Port

Displays the port number.

Utilization [%]

Displays the current utilization in percent in relation to the time interval specified in the [Control interval \[s\]](#) column.

The utilization is the relationship between the received data quantity and the maximum possible data quantity at the currently set data rate.

Lower threshold [%]

Specifies the lower notification threshold value for the network load. If the network load on the port falls below this value, then the status of the checkbox in the *Alarm* column changes to *marked*.

Possible values:

- ▶ 0.00..100.00 (default setting: 0.00)

The value 0 or 0.00 deactivates the lower notification threshold value.

Upper threshold [%]

Specifies the upper notification threshold value for the network load. If the network load on the port exceeds this value, then the status of the checkbox in the *Alarm* column changes to *marked*.

Possible values:

- ▶ 0.00..100.00 (default setting: 0.00)

The value 0 or 0.00 deactivates the upper notification threshold value.

Control interval [s]

Specifies the interval in seconds by which the device determines and possibly limits the network load.

Possible values:

- ▶ 1..3600 (default setting: 30)

Alarm

Displays the utilization alarm status.

Possible values:

- ▶ *marked*
The network load on the port is below the value specified in the *Lower threshold [%]* column or above the value specified in the *Upper threshold [%]* column. The device sends an SNMP trap. The prerequisite is that in the *Diagnostics > Status Configuration > Alarms (Traps)* dialog the *Alarms (Traps)* function is enabled and at least one trap destination is specified.
- ▶ *unmarked*
The network load on the port is between the lower and the upper notification threshold values.

1.7 Restart

[Basic Settings > Restart]

This dialog lets you restart the device, reset port counters and the MAC address table (forwarding database), and delete log files.

Restart

Cold start...

Opens the [Restart](#) window to initiate an immediate or delayed restart of the device.

If the configuration profile in the volatile memory (*RAM*) and the "Selected" configuration profile in the non-volatile memory (*NVM*) differ, then the device displays the [Warning](#) window.

- To permanently save the settings, click the [Yes](#) button in the [Warning](#) window.
- To discard the changed settings, click the [No](#) button in the [Warning](#) window.
- In the [Restart in](#) field you specify the delay time for the delayed restart.

Possible values:

- ▶ [00:00:00..596:31:23](#) (default setting: [00:00:00](#))
Hour:Minute:Second

When the delay time elapses, the device restarts and goes through the following phases:

- If you activate the function in the [Diagnostics > System > Selftest](#) dialog, then the device performs a RAM test.
- The device starts the device software that the [Stored version](#) field displays in the [Basic Settings > Software](#) dialog.
- The device loads the settings from the "Selected" configuration profile. See the [Basic Settings > Load/Save](#) dialog.

Note: During the restart, the device does not transfer any data. During this time, the device cannot be accessed by the Graphical User Interface or other management systems.

Restart in

Displays the remaining time in days, hours, minutes, seconds until the device restarts.

To update the display of the remaining time, click the  button.

Cancel

Aborts a delayed restart.

Buttons

Clear FDB

Removes the MAC addresses from the forwarding table that have in the [Switching > Filter for MAC Addresses](#) dialog the value [Learned](#) in the [Status](#) column.

Clear ARP table

Removes the dynamically set up addresses from the ARP table.

See the [Diagnostics > System > ARP](#) dialog.

Clear port statistics

Resets the counter for the port statistics to 0.

See the [Basic Settings > Port](#) dialog, [Statistics](#) tab.

Clear IGMP snooping data

Removes the IGMP Snooping entries and resets the counter in the [Information](#) frame to 0.

See the [Switching > IGMP Snooping > Global](#) dialog.

Clear log file

Removes the logged events from the log file.

See the [Diagnostics > Report > System Log](#) dialog.

Clear persistent log file

Removes the log files from the external memory.

See the [Diagnostics > Report > Persistent Logging](#) dialog.

2 Time

The menu contains the following dialogs:

- ▶ Basic Settings
- ▶ SNTP
- ▶ PTP
- ▶ 802.1AS

2.1 Basic Settings

[Time > Basic Settings]

The device is equipped with a buffered hardware clock. This clock keeps the correct time if the power supply becomes inoperable, or you disconnect the device from the power supply. After the system startup, the correct time is available again, for example, for log entries.

The hardware clock bridges a power supply downtime of 3 hours. The prerequisite is that the power supply of the device has been connected continuously for at least 5 minutes beforehand.

In this dialog, you specify time-related settings independently of the time synchronization protocol specified.

The dialog contains the following tabs:

- ▶ [Global]
- ▶ [Daylight saving time]

[Global]

In this tab, you specify the system time and the time zone.

Configuration

System time (UTC)

Displays the date and time in Universal Time Coordinated (UTC) format.

Set time from PC

The device takes over the time from your computer as the system time.

System time

Displays the local date and time: $\text{System time} = \text{System time (UTC)} + \text{Local offset [min]} + \text{Daylight saving time}$

Time source

Displays the time source from which the device obtains the time information.

The device automatically selects the available time source with the greatest accuracy.

Possible values:

- ▶ *Local*
System clock of the device.
- ▶ *sntp*
The *SNTP* client is enabled, and the device is synchronized by an *SNTP* server. See the [Time > SNTP](#) dialog.
- ▶ *ptp*
The *PTP* function is enabled, and the device clock is synchronized with a *PTP master clock*. See the [Time > PTP](#) dialog.

Local offset [min]

Specifies the difference in minutes between Universal Time Coordinated (UTC) and local time:

$Local\ offset\ [min] = System\ time - System\ time\ (UTC)$

Possible values:

- ▶ *-780..840* (default setting: *60*)

[Daylight saving time]

In this tab, you enable/disable the *Daylight saving time* function. You specify the start and end of summer time using a pre-defined profile. As an alternative, you specify these settings individually. During the summer time, the device advances the local time by one hour.

Operation

Daylight saving time

Enables/disables the *Daylight saving time* mode.

Possible values:

- ▶ *On*
The *Daylight saving time* mode is enabled.
The device automatically sets the clock forward to summer time and back again.
- ▶ *Off* (default setting)
The *Daylight saving time* mode is disabled.

You specify the daylight saving time settings in the *Summertime begin* and *Summertime end* frames.

Profile...

Opens the *Profile...* window to select a pre-defined profile for the start and end of summer time. Selecting a profile overwrites the settings specified in the *Summertime begin* and *Summertime end* frames.

Possible values:

- ▶ *EU*
Daylight saving time settings as applicable in the European Union.
- ▶ *USA*
Daylight saving time settings as applicable in the United States.

Summertime begin

In this frame, you specify the time at which the device sets the clock forward from standard time to summer time. In the first 3 fields, you specify the day for the start of summer time. In the last field, you specify the time.

Week

Specifies the week in the current month.

Possible values:

- ▶ - (default setting)
- ▶ *first*
- ▶ *second*
- ▶ *third*
- ▶ *fourth*
- ▶ *Last*

Day

Specifies the day of the week.

Possible values:

- ▶ - (default setting)
- ▶ *Sunday*
- ▶ *Monday*
- ▶ *Tuesday*
- ▶ *Wednesday*
- ▶ *Thursday*
- ▶ *Friday*
- ▶ *Saturday*

Month

Specifies the month.

Possible values:

- ▶ - (default setting)
- ▶ *January*

- ▶ *February*
- ▶ *March*
- ▶ *April*
- ▶ *May*
- ▶ *June*
- ▶ *July*
- ▶ *August*
- ▶ *September*
- ▶ *October*
- ▶ *November*
- ▶ *December*

System time

Specifies the time at which the device sets the clock forward to summer time.

Possible values:

- ▶ *<HH:MM>* (default setting: *00:00*)

Summertime end

In this frame, you specify the time at which the device resets the clock from summer time to standard time. In the first 3 fields, you specify the day for the end of summer time. In the last field, you specify the time.

Week

Specifies the week in the current month.

Possible values:

- ▶ *-* (default setting)
- ▶ *first*
- ▶ *second*
- ▶ *third*
- ▶ *fourth*
- ▶ *Last*

Day

Specifies the day of the week.

Possible values:

- ▶ *-* (default setting)
- ▶ *Sunday*
- ▶ *Monday*
- ▶ *Tuesday*
- ▶ *Wednesday*
- ▶ *Thursday*

- ▶ *Friday*
- ▶ *Saturday*

Month

Specifies the month.

Possible values:

- ▶ - (default setting)
- ▶ *January*
- ▶ *February*
- ▶ *March*
- ▶ *April*
- ▶ *May*
- ▶ *June*
- ▶ *July*
- ▶ *August*
- ▶ *September*
- ▶ *October*
- ▶ *November*
- ▶ *December*

System time

Specifies the time at which the device resets the clock to standard time.

Possible values:

- ▶ *<HH:MM>* (default setting: *00:00*)

2.2 SNTP

[Time > SNTP]

The Simple Network Time Protocol (SNTP) is a procedure described in the RFC 4330 for time synchronization in the network.

With the SNTP client function, the device lets you synchronize the local system clock with an external NTP or SNTP server.

As the SNTP server, the device makes the time information available to other devices in the network.

The menu contains the following dialogs:

- ▶ *SNTP Client*
- ▶ *SNTP Server*

2.2.1 SNTP Client

[Time > SNTP > Client]

In this dialog, you specify the settings with which the device operates as an SNTP client. As an SNTP client, the device obtains time information from an external NTP or SNTP servers and synchronizes the local system clock with the time from the time server.

Operation

Operation

Enables/disables the *Client* function in the device. Note the setting in the *Disable client after successful sync* checkbox in the *Configuration* frame.

Possible values:

- ▶ *On*
The *Client* function is enabled.
The device operates as an SNTP client.
- ▶ *Off* (default setting)
The *Client* function is disabled.

State

State

Displays the status of the *Client* function.

Possible values:

- ▶ *disabled*
The SNTP client is not operating.
- ▶ *notSynchronized*
The SNTP client is operating.
The local system clock is not in sync with an external NTP or SNTP server.
- ▶ *synchronizedToRemoteServer*
The SNTP client is not operating.
The local system clock is in sync with an external NTP or SNTP server.

Configuration

Mode

Specifies if the device actively requests the time information from an external NTP or SNTP server set up in the device (*unicast* mode) or passively waits for the time information from a random NTP or SNTP server (*broadcast* mode).

Possible values:

- ▶ *unicast* (default setting)
The device takes the time information only from one of the set-up NTP or SNTP servers. The device sends Unicast requests to the external SNTP or NTP server and evaluates the response of the server.
- ▶ *broadcast*
The device obtains the time information from a random NTP or SNTP server. The device evaluates the Broadcasts or Multicasts from this server.

Request interval [s]

Specifies the interval in seconds at which the device requests time information from the external NTP or SNTP server.

Possible values:

- ▶ *5..3600* (default setting: *30*)

Broadcast rcv timeout [s]

Specifies the time in seconds the device operating in *broadcast* mode waits before changing the value in the *State* field from *syncToRemoteServer* to *notSynchronized* when it does not receive Broadcast packets. See the *State* frame.

Possible values:

- ▶ *128..2048* (default setting: *320*)

Disable client after successful sync

Activates/deactivates the automatic disabling of the *SNTP Client* function after the device has successfully synchronized its local system clock.

Possible values:

- ▶ *marked*
The automatic disabling of the *SNTP Client* function is active.
The device disables the *SNTP Client* function after it has successfully synchronized its local system clock.
- ▶ *unmarked* (default setting)
The automatic disabling of the *SNTP Client* function is inactive.
The device keeps the *SNTP Client* function enabled after it has successfully synchronized its local system clock.

Table

In the table, you specify the settings for up to 4 external NTP or SNTP servers. After enabling the function, the device sends requests to the server set up in the first table row.

When the external NTP or SNTP server does not respond, the device sends its request to the server set up in the next table row. When the device does not receive a response, it cyclically sends requests to each set-up NTP or SNTP server until it receives a valid time from one of these servers. The device synchronizes its local system clock with the first responding NTP or SNTP server, even if an server ahead in the table will be reachable again later.

For information on how to customize the appearance of the table, see [“Working with tables” on page 16](#).

Buttons



Add

Adds a table row.



Remove

Removes the selected table row.

Index

Displays the index number to which the table row relates.

The device automatically assigns the value when you add a table row. When you delete a table row, this leaves a gap in the numbering. When you add a table row, the device fills the first gap.

Name

Specifies a name for the external NTP or SNTP server.

Possible values:

- ▶ Alphanumeric ASCII character string with 1..32 characters

IP address

Specifies the IP address of the external NTP or SNTP server.

Possible values:

- ▶ Valid IPv4 address (default setting: 0.0.0.0)
- ▶ Valid IPv6 address

Destination UDP port

Specifies the UDP port on which the external NTP or SNTP server listens for requests.

Possible values:

- ▶ 1..65535 ($2^{16}-1$) (default setting: 123)
Exception: Port 2222 is reserved for internal functions.

Status

Displays the connection status between the device and the external NTP or SNTP server.

Possible values:

- ▶ *success*
The device has successfully synchronized the local system clock with the external NTP or SNTP server.
- ▶ *badDateEncoded*
Synchronization was unsuccessful. The time information received contains protocol errors.
- ▶ *other*
Synchronization was unsuccessful.
 - The IP address *0.0.0.0* is specified for the external NTP or SNTP server.
 - or
 - The device is using a different external NTP or SNTP server.
- ▶ *requestTimedOut*
Synchronization was unsuccessful. The device has not received a response from the external NTP or SNTP server.
- ▶ *serverKissOfDeath*
Synchronization was unsuccessful. The external NTP or SNTP server is overloaded. The device is requested to synchronize its system clock with another NTP or SNTP server. When no other NTP or SNTP server is available, the device checks at intervals longer than the value in the *Request interval [s]* field, if the server is still overloaded.
- ▶ *serverUnsynchronized*
Synchronization was unsuccessful. The external NTP or SNTP server is not in sync with a reference time source.
- ▶ *versionNotSupported*
Synchronization was unsuccessful. The SNTP versions of the client and server are incompatible.

Active

Activates/deactivates the connection to the external NTP or SNTP server.

Possible values:

- ▶ *marked*
The connection to the external NTP or SNTP server is activated.
The device has the option to access to the server.
- ▶ *unmarked* (default setting)
The connection to the external NTP or SNTP server is deactivated.
The device does not have the option to access to the server.

2.2.2 SNTP Server

[Time > SNTP > Server]

In this dialog, you specify the settings with which the device operates as an SNTP server. As the SNTP server, the device makes the time information available to other devices in the network. The device provides the Universal Time Coordinated (UTC) without considering local time differences.

If set accordingly, the SNTP server on the device operates in Broadcast mode. In Broadcast mode, the device makes the time information available to other devices in the network by sending Broadcasts or Multicasts.

Operation

Operation

Enables/disables the *Server* function in the device. Note the setting in the *Disable server at local time source* checkbox in the *Configuration* frame.

Possible values:

- ▶ *On*
The *Server* function is enabled.
The device operates as an *SNTP* server.
- ▶ *Off* (default setting)
The *Server* function is disabled.

State

State

Displays the state of the *Server* function on the device.

Possible values:

- ▶ *disabled*
The SNTP server is not operating.
- ▶ *notSynchronized*
The SNTP server is operating.
The local system clock is not in sync with a reference time source.
- ▶ *syncToLocal*
The SNTP server is operating.
The local system clock is in sync with the hardware clock of the device.
- ▶ *syncToRefcLock*
The SNTP server is operating.
The local system clock is in sync with an external reference time source, like a PTP clock.
- ▶ *syncToRemoteServer*
The SNTP server is operating.
The local system clock is in sync with an external NTP or SNTP server which is superordinate to the device in a cascade.

Configuration

UDP port

Specifies the UDP port on which the device listens for requests.

Possible values:

- ▶ [1..65535 \(2¹⁶-1\)](#) (default setting: [123](#))
Exception: Port [2222](#) is reserved for internal functions.

Broadcast admin mode

Activates/deactivates the Broadcast mode.

Possible values:

- ▶ [marked](#)
The device sends SNTP packets as Broadcasts or Multicasts.
The device also responds to SNTP requests in unicast mode.
- ▶ [unmarked](#) (default setting)
The device responds to SNTP requests in unicast mode, but sends no Broadcast packets on its own.

Broadcast destination address

Specifies the destination IP address to which the device sends the SNTP packets in Broadcast mode.

Possible values:

- ▶ Valid IPv4 address (default setting: [0.0.0.0](#))
Broadcast and Multicast addresses are permitted.

Broadcast UDP port

Specifies the UDP port on which the device sends the SNTP packets in Broadcast mode.

Possible values:

- ▶ [1..65535 \(2¹⁶-1\)](#) (default setting: [123](#))
Exception: Port [2222](#) is reserved for internal functions.

Broadcast VLAN ID

Specifies the VLAN to which the device sends the SNTP packets in Broadcast mode.

Possible values:

- ▶ [0](#)
The device sends the SNTP packets in the same VLAN in which the device management access occurs. See the [Basic Settings > Network > Global](#) dialog.
- ▶ [1..4042](#) (default setting: [1](#))

Broadcast send interval [s]

Specifies the interval in seconds at which the device broadcasts SNTP packets.

Possible values:

- ▶ 64..1024 (default setting: 128)

Disable server at local time source

Activates/deactivates the automatic disabling of the *SNTP Server* function if the local system clock is not in sync with another external time reference.

Possible values:

- ▶ **marked**
The automatic disabling of the *SNTP Server* function is active.
If the device has synchronized its local system clock to an external time reference, like a PTP clock, then it keeps the *SNTP Server* function enabled. Otherwise, the device disables the *SNTP Server* function.
- ▶ **unmarked** (default setting)
The automatic disabling of the *SNTP Server* function is inactive.
The device keeps the *SNTP Server* function enabled, regardless of whether it has synchronized its local system clock to an external time reference.
If the local system clock is not in sync with an external time reference, then in the SNTP packet, the device informs the client that its system clock is synchronized locally.

2.3 PTP

[Time > PTP]

The menu contains the following dialogs:

- ▶ PTP Global
- ▶ PTP Boundary Clock
- ▶ PTP Transparent Clock

2.3.1 PTP Global

[Time > PTP > Global]

In this dialog, you specify basic settings for the *PTP* function.

The Precision Time Protocol (PTP) is a procedure defined in IEEE 1588-2008 that supplies the devices in the network with a precise time. The method synchronizes the clocks in the network with a precision of a few 100 ns. The protocol uses Multicast communication, so the load on the network due to the *PTP* synchronization messages is negligible.

PTP is significantly more accurate than SNTP. If the *SNTP* function and the *PTP* function are enabled in the device at the same time, then the *PTP* function has priority.

With the *Best Master Clock Algorithm*, the devices in the network determine which device has the most accurate time. The devices use the device with the most accurate time as the reference time source (*Grandmaster*). Subsequently the participating devices synchronize themselves with this reference time source.

If you want to transport PTP time accurately through the network, then use only devices with PTP hardware support on the transport paths.

The protocol differentiates between the following clocks:

- *Boundary Clock (BC)*
This clock has any number of PTP ports and operates as both *PTP* master and *PTP* slave. In its respective network segment, the clock operates as an Ordinary Clock.
 - As *PTP* slave, the clock synchronizes itself with a *PTP* master that is higher than the device in the cascade.
 - As *PTP* master, the clock forwards the time information through the network to *PTP* slaves that are higher than the device in the cascade.
- *Transparent Clock (TC)*
This clock has any number of PTP ports. In contrast to the *Boundary Clock*, this clock corrects the time information before forwarding it, without synchronizing itself.

Operation IEEE1588/PTP

Operation IEEE1588/PTP

Enables/disables the *PTP* function.

Possible values:

- ▶ *On*
The *PTP* function is enabled.
The device synchronizes its clock with PTP.
If the *SNTP* function and the *PTP* function are enabled in the device at the same time, then the *PTP* function has priority.
- ▶ *Off* (default setting)
The *PTP* function is disabled.
The device transmits the *PTP* synchronization messages without any correction on every port.

Configuration IEEE1588/PTP

PTP mode

Specifies the PTP version and mode of the local clock.

Possible values:

- ▶ `v2-transparent-clock` (default setting)
- ▶ `v2-boundary-clock`

Sync lower bound [ns]

Specifies the lower threshold value in nanoseconds for the path difference between the local clock and the reference time source (*Grandmaster*). If the path difference falls below this value once, then the local clock is classed as synchronized.

Possible values:

- ▶ `1..999999999 (109-1)` (default setting: 30)

Sync upper bound [ns]

Specifies the upper threshold value in nanoseconds for the path difference between the local clock and the reference time source (*Grandmaster*). If the path difference exceeds this value once, then the local clock is classed as unsynchronized.

Possible values:

- ▶ `31..1000000000 (109)` (default setting: 5000)

PTP management

Activates/deactivates the PTP management defined in the PTP standard.

Possible values:

- ▶ `marked`
PTP management is activated.
- ▶ `unmarked` (default setting)
PTP management is deactivated.

Status

Is synchronized

Displays if the local system clock is synchronized with the reference time source (*Grandmaster*).

If the path difference between the local clock and the reference time source (*Grandmaster*) falls below the synchronization lower threshold value one time, then the local clock is synchronized. This status is kept until the path difference exceeds the synchronization upper threshold value one time.

You specify the synchronization threshold values in the [Configuration IEEE1588/PTP](#) frame.

Max. offset absolute [ns]

Displays the maximum path difference in nanoseconds that has occurred since the local system clock was synchronized with the reference time source (*Grandmaster*).

PTP time

Displays the date and time for the PTP time scale when the local clock is synchronized with the reference time source (*Grandmaster*). Format: [Month Day, Year](#) [hh:mm:ss AM/PM](#)

2.3.2 PTP Boundary Clock

[Time > PTP > Boundary Clock]

With this menu you can set up the *Boundary Clock* mode for the local clock.

The menu contains the following dialogs:

- ▶ [PTP Boundary Clock Global](#)
- ▶ [PTP Boundary Clock Port](#)

2.3.2.1 PTP Boundary Clock Global

[Time > PTP > Boundary Clock > Global]

In this dialog, you specify general, cross-port settings for the *Boundary Clock* mode for the local clock. The *Boundary Clock (BC)* operates according to PTP version 2 (IEEE 1588-2008).

The settings are effective when the local clock operates as the *Boundary Clock (BC)*. For this, you select in the *Time > PTP > Global* dialog in the *PTP mode* field the value *v2-boundary-cLock*.

Operation IEEE1588/PTPv2 BC

Priority 1

Specifies *priority 1* for the device.

Possible values:

▶ 0..255 (default setting: 128)

The *Best Master Clock* algorithm first evaluates *priority 1* among the participating devices to determine the reference time source (*Grandmaster*).

The lower you set this value, the more probable it is that the device becomes the reference time source (*Grandmaster*). See the *Grandmaster* frame.

Priority 2

Specifies *priority 2* for the device.

Possible values:

▶ 0..255 (default setting: 128)

When the previously evaluated criteria are the same for multiple devices, the *Best Master Clock Algorithm* evaluates *priority 2* of the participating devices.

The lower you set this value, the more probable it is that the device becomes the reference time source (*Grandmaster*). See the *Grandmaster* frame.

Domain number

Assigns the device to a *PTP* domain.

Possible values:

▶ 0..255 (default setting: 0)

The device transmits time information from and to devices only in the same domain.

Status IEEE1588/PTPv2 BC

Two step

Displays that the clock is operating in Two-Step mode.

Steps removed

Displays the number of communication paths passed through between the local clock of the device and the reference time source (*Grandmaster*).

For a *PTP* slave, the value **1** means that the clock is connected with the reference time source (*Grandmaster*) directly through one communication path.

Offset to master [ns]

Displays the measured difference (offset) between the local clock and the reference time source (*Grandmaster*) in nanoseconds. The *PTP* slave calculates the difference from the time information received.

In Two-Step mode the time information consists of 2 *PTP* synchronization messages each, which the *PTP* master sends cyclically:

- The first synchronization message (sync message) contains an estimated value for the exact sending time of the message.
- The second synchronization message (follow-up message) contains the exact sending time of the first message.

The *PTP* slave uses the two *PTP* synchronization messages to calculate the difference (offset) from the master and corrects its clock by this difference. Here the *PTP* slave also considers the *Delay to master [ns]* value.

Delay to master [ns]

Displays the delay when transmitting the *PTP* synchronization messages from the *PTP* master to the *PTP* slave in nanoseconds.

The *PTP* slave sends a “Delay Request” packet to the *PTP* master and thus determines the exact sending time of the packet. When it receives the packet, the *PTP* master generates a time stamp and sends this in a “Delay Response” packet back to the *PTP* slave. The *PTP* slave uses the two packets to calculate the delay, and considers this starting from the next offset measurement.

The prerequisite is that in the *Time > PTP > Boundary Clock > Port* dialog, *Delay mechanism* column, the value *e2e* is specified for the slave ports.

Grandmaster

This frame displays the criteria that the *Best Master Clock Algorithm* uses when evaluating the reference time source (*Grandmaster*).

The algorithm first evaluates *priority 1* of the participating devices. The device with the numerically lowest value for *priority 1* is designated as the reference time source (*Grandmaster*). When the value is the same for multiple devices, the algorithm takes the next criterion, and when this is also the same, the algorithm takes the next criterion after this one. When every value is the same for multiple devices, the numerically lowest value in the *Clock identity* field decides which device is designated as the reference time source (*Grandmaster*).

The device lets you influence which device in the network is designated as the reference time source (*Grandmaster*). To do this, modify the value in the *Priority 1* field or the *Priority 2* field in the *Operation IEEE1588/PTPv2 BC* frame.

Priority 1

Displays the *priority 1* value for the device that is currently the reference time source (*Grandmaster*).

Clock class

Displays the class of the reference time source (*Grandmaster*). Parameter for the *Best Master Clock Algorithm*.

Clock accuracy

Displays the estimated accuracy of the reference time source (*Grandmaster*). Parameter for the *Best Master Clock Algorithm*.

Clock variance

Displays the variance of the reference time source (*Grandmaster*), also known as the *Offset scaled log variance*. Parameter for the *Best Master Clock Algorithm*.

Priority 2

Displays the *priority 2* value for the device that is currently the reference time source (*Grandmaster*).

Local time properties

Time source

Specifies the time source from which the local clock gets its time information.

Possible values:

- ▶ *atomicClock*
- ▶ *gps*
- ▶ *terrestrialRadio*
- ▶ *ptp*
- ▶ *ntp*
- ▶ *handSet*
- ▶ *other*
- ▶ *internalOscillator* (default setting)

UTC offset [s]

Specifies the difference between the *PTP* time scale and the Universal Time Coordinated (UTC).

See the *PTP timescale* checkbox.

Possible values:

- ▶ $-32768..32767 (2^{15}-1)$

Note: The default setting is the value valid on the creation date of the device software. For further information, see the "Bulletin C" of the Earth Rotation and Reference Systems Service (IERS): <https://www.iers.org/IERS/EN/Publications/Bulletins/bulletins.html>

UTC offset valid

Specifies if the value specified in the *UTC offset [s]* field is correct.

Possible values:

- ▶ `marked`
- ▶ `unmarked` (default setting)

Time traceable

Displays if the device obtains the time from a primary UTC reference, for example from an NTP server.

Possible values:

- ▶ `marked`
- ▶ `unmarked`

Frequency traceable

Displays if the device obtains the frequency from a primary UTC reference, for example from an NTP server.

Possible values:

- ▶ `marked`
- ▶ `unmarked`

PTP timescale

Displays if the device uses the PTP time scale.

Possible values:

- ▶ `marked`
- ▶ `unmarked`

According to IEEE 1588, the PTP time scale is the TAI atomic time started on 01.01.1970.

In contrast to Universal Time Coordinated (UTC), TAI does not use leap seconds.

As of July 1, 2020, the TAI time is 37 s ahead of the Universal Time Coordinated (UTC).

Identities

The device displays the identities as byte sequences in hexadecimal notation.

The identification numbers (UUID) are made up as follows:

- The device identification number consists of the MAC address of the device, with the values `ff` and `fe` added between byte 3 and byte 4.
- The port UUID consists of the device identification number followed by a 16-bit port ID.

Clock identity

Displays the identification number (UUID) of the device.

Parent port identity

Displays the port identification number (UUID) of the directly superior master device.

Grandmaster identity

Displays the identification number (UUID) of the reference time source (*Grandmaster*) device.

2.3.2.2 PTP Boundary Clock Port

[Time > PTP > Boundary Clock > Port]

In this dialog, you specify the *Boundary Clock (BC)* settings on each individual port.

The settings are effective when the local clock operates as the *Boundary Clock (BC)*. For this, you select in the *Time > PTP > Global* dialog in the *PTP mode* field the value *v2-boundary-cLock*.

Table

For information on how to customize the appearance of the table, see “[Working with tables](#)” on [page 16](#).

Port

Displays the port number.

PTP enable

Activates/deactivates transmitting *PTP* synchronization messages on the port.

Possible values:

- ▶ *marked* (default setting)
The transmission is activated. The port forwards and receives *PTP* synchronization messages.
- ▶ *unmarked*
The transmission is deactivated. The port blocks *PTP* synchronization messages.

PTP status

Displays the current status of the port.

Possible values:

- ▶ *initializing*
Initialization phase
- ▶ *faulty*
Faulty mode: error in the Precision Time Protocol (PTP).
- ▶ *disabled*
PTP is disabled on the port.
- ▶ *listening*
Device port is waiting for *PTP* synchronization messages.
- ▶ *pre-master*
PTP pre-master mode
- ▶ *master*
PTP master mode
- ▶ *passive*
PTP passive mode
- ▶ *uncalibrated*
PTP uncalibrated mode
- ▶ *slave*
PTP slave mode

Network protocol

Specifies which protocol the port uses to transmit the *PTP* synchronization messages.

Possible values:

- ▶ *802.3* (default setting)
- ▶ *UDP/IPv4*

Announce interval [s]

Specifies the interval in seconds at which the port transmits messages for the PTP topology discovery.

Assign the same value to every device of a *PTP* domain.

Possible values:

- ▶ 1
- ▶ 2 (default setting)
- ▶ 4
- ▶ 8
- ▶ 16

Announce timeout

Specifies the number of announce intervals.

Example:

For the default setting (*Announce interval [s]* = 2 and *Announce timeout* = 3), the timeout is $3 \times 2 \text{ s} = 6 \text{ s}$.

Possible values:

- ▶ *2..10* (default setting: 3)
Assign the same value to every device of a *PTP* domain.

Sync interval

Specifies the interval in seconds at which the port transmits *PTP* synchronization messages.

Possible values:

- ▶ 0.25
- ▶ 0.5
- ▶ 1 (default setting)
- ▶ 2

Delay mechanism

Specifies the mechanism with which the device measures the delay for transmitting the *PTP* synchronization messages.

Possible values:

- ▶ *disabled*
The measurement of the delay for the *PTP* synchronization messages for the connected PTP devices is inactive.

- ▶ *e2e* (default setting)
End-to-End: As the *PTP* slave, the port measures the delay for the *PTP* synchronization messages to the *PTP* master.
The device displays the measured value in the *Time > PTP > Boundary Clock > Global* dialog.
- ▶ *p2p*
Peer-to-Peer: The device measures the delay for the *PTP* synchronization messages for the connected *PTP* devices, provided that these devices support P2P.
This mechanism spares the device from having to determine the delay again in the case of a reconfiguration.

P2P delay

Displays the measured Peer-to-Peer delay for the *PTP* synchronization messages.

The prerequisite is that in the *Delay mechanism* column the value *p2p* is specified.

P2P delay interval [s]

Specifies the interval in seconds at which the port measures the Peer-to-Peer delay.

The prerequisite is that in the *Delay mechanism* column the value *p2p* is specified for this port and for the port of the remote device.

Possible values:

- ▶ 1 (default setting)
- ▶ 2
- ▶ 4
- ▶ 8
- ▶ 16
- ▶ 32

E2E delay interval [s]

Displays the interval in seconds at which the port measures the End-to-End delay.

Possible values:

- ▶ When the port is operating as the *PTP* master, the device assigns to the port the value 8.
- ▶ When the port is operating as the *PTP* slave, the value is specified by the *PTP* master connected to the port.

Asymmetry

Corrects the measured delay value corrupted by asymmetrical transmission paths.

Possible values:

- ▶ -2000000000..2000000000 (default setting: 0)

The value represents the delay symmetry in nanoseconds.

A measured delay value of y ns corresponds to an asymmetry of $y \times 2$ ns.

The value is positive if the delay from the *PTP* master to the *PTP* slave is longer than in the opposite direction.

VLAN

Specifies the VLAN ID that the device uses to tag the received *PTP* synchronization messages on this port.

Possible values:

- ▶ *none* (default setting)
The device transmits *PTP* synchronization messages without a VLAN tag.
- ▶ *0..4042*
You specify VLANs that you have already set up in the device from the list.

Verify that the port is a member of the VLAN.

See the [Switching > VLAN > Configuration](#) dialog.

VLAN priority

Specifies the priority with which the device transmits the *PTP* synchronization messages marked with a VLAN ID (Layer 2, IEEE 802.1D).

Possible values:

- ▶ *0..7* (default setting: 6)

If you specified in the *VLAN* column the value *none*, then the device ignores the VLAN priority.

2.3.3 PTP Transparent Clock

[Time > PTP > Transparent Clock]

With this menu you can set up the *Transparent Clock* mode for the local clock.

The menu contains the following dialogs:

- ▶ [PTP Transparent Clock Global](#)
- ▶ [PTP Transparent Clock Port](#)

2.3.3.1 PTP Transparent Clock Global

[Time > PTP > Transparent Clock > Global]

In this dialog, you specify general, cross-port settings for the *Transparent Clock* mode for the local clock. The *Transparent Clock (TC)* operates according to PTP version 2 (IEEE 1588-2008).

The settings are effective when the local clock operates as the *Transparent Clock (TC)*. For this, you select in the *Time > PTP > Global* dialog in the *PTP mode* field the value *v2-transparent-cLock*.

Operation IEEE1588/PTPv2 TC

Delay mechanism

Specifies the mechanism with which the device measures the delay for transmitting the *PTP* synchronization messages.

Possible values:

- ▶ *e2e* (default setting)
As the *PTP* slave, the port measures the delay for the *PTP* synchronization messages to the *PTP* master.
The device displays the measured value in the *Time > PTP > Transparent Clock > Global* dialog.
- ▶ *p2p*
The device measures the delay for the *PTP* synchronization messages for every connected PTP device, provided that the device supports P2P.
This mechanism spares the device from having to determine the delay again in the case of a reconfiguration.
If you specify this value, then the value *802.3* is only available in the *Network protocol* column.
- ▶ *e2e-optimized*
Like *e2e*, with the following special characteristics:
 - The device transmits the delay requests of the *PTP* slaves only to the *PTP* master, even though these requests are multicast messages. The device thus spares the other devices from unnecessary multicast requests.
 - If the master-slave topology changes, then the device relearns the port for the *PTP* master as soon as it receives a synchronization message from another *PTP* master.
 - If the device does not know a *PTP* master, then the device transmits delay requests to the ports.
- ▶ *disabled*
The delay measuring is disabled on the port. The device discards messages for the delay measuring.

Primary domain

Assigns the device to a *PTP* domain.

Possible values:

- ▶ *0..255* (default setting: *0*)

The device transmits time information from and to devices only in the same domain.

Network protocol

Specifies which protocol the port uses to transmit the *PTP* synchronization messages.

Possible values:

- ▶ *ieee8023* (default setting)
- ▶ *udpIpv4*

Multi domain mode

Activates/deactivates the *PTP* synchronization message correction in every *PTP* domain.

Possible values:

- ▶ *marked*
The device corrects *PTP* synchronization messages in every *PTP* domain.
- ▶ *unmarked* (default setting)
The device corrects *PTP* synchronization messages only in the primary *PTP* domain. See the *Primary domain* field.

VLAN ID

Specifies the VLAN ID with which the device marks the *PTP* synchronization messages on this port.

Possible values:

- ▶ *none* (default setting)
The device transmits *PTP* synchronization messages without a VLAN tag.
- ▶ *0..4042*
You specify VLANs that you have already set up in the device from the list.

VLAN priority

Specifies the priority with which the device transmits the *PTP* synchronization messages marked with a VLAN ID (Layer 2, IEEE 802.1D).

Possible values:

- ▶ *0..7* (default setting: 6)

If you specified the value *none* in the *VLAN ID* field, then the device ignores the specified value.

Local synchronization

Syntonize

Activates/deactivates the frequency synchronization of the *Transparent Clock* with the *PTP* master.

Possible values:

- ▶ *marked* (default setting)
The frequency synchronization is active.
The device synchronizes the frequency.
- ▶ *unmarked*
The frequency synchronization is inactive.
The frequency remains constant.

Synchronize local clock

Activates/deactivates the synchronization of the local system time.

Possible values:

- ▶ **marked**
The synchronization is active.
The device synchronizes the local system time with the time received using PTP. The prerequisite is that the *Syntonize* checkbox is marked.
- ▶ **unmarked** (default setting)
The synchronization is inactive.
The local system time remains constant.

Current master

Displays the port identification number (UUID) of the directly superior master device on which the device synchronizes its frequency.

If the value contains only zeros, this is because:

- The *Syntonize* function is disabled.
- or
- The device cannot find a *PTP* master.

Offset to master [ns]

Displays the measured difference (offset) between the local clock and the *PTP* master in nanoseconds. The device calculates the difference from the time information received.

The prerequisite is that the *Synchronize local clock* function is enabled.

Delay to master [ns]

Displays the delay when transmitting the *PTP* synchronization messages from the *PTP* master to the *PTP* slave in nanoseconds.

Prerequisites:

- The *Synchronize local clock* function is enabled.
- In the *Delay mechanism* field, the value *e2e* is selected.

Status IEEE1588/PTPv2 TC

Clock identity

Displays the identification number (UUID) of the device.

The device displays the identities as byte sequences in hexadecimal notation.

The device identification number consists of the MAC address of the device, with the values *ff* and *fe* added between byte 3 and byte 4.

2.3.3.2 PTP Transparent Clock Port

[Time > PTP > Transparent Clock > Port]

In this dialog, you specify the *Transparent Clock (TC)* settings on each individual port.

The settings are effective when the local clock operates as the *Transparent Clock (TC)*. For this, you select in the *Time > PTP > Global* dialog in the *PTP mode* field the value *v2-transparent-cLock*.

Table

For information on how to customize the appearance of the table, see “[Working with tables](#)” on [page 16](#).

Port

Displays the port number.

PTP enable

Activates/deactivates transmitting *PTP* synchronization messages on the port.

Possible values:

- ▶ **marked** (default setting)
The transmitting is active.
The port forwards and receives *PTP* synchronization messages.
- ▶ **unmarked**
The transmitting is inactive.
The port blocks *PTP* synchronization messages.

P2P delay interval [s]

Specifies the interval in seconds at which the port measures the Peer-to-Peer delay.

The prerequisite is that in the *Time > PTP > Transparent Clock > Global* dialog, *Delay mechanism* option list, the radio button *p2p* is selected for this port and for the port of the remote device.

Possible values:

- ▶ **1** (default setting)
- ▶ 2
- ▶ 4
- ▶ 8
- ▶ 16
- ▶ 32

P2P delay

Displays the measured Peer-to-Peer delay for the *PTP* synchronization messages.

The prerequisite is that in the *Time > PTP > Transparent Clock > Global* dialog, *Delay mechanism* option list, the radio button *p2p* is selected.

Asymmetry

Corrects the measured delay value corrupted by asymmetrical transmission paths.

Possible values:

▶ `-2000000000..2000000000 (2 × 109)` (default setting: 0)

The value represents the delay symmetry in nanoseconds.

A measured delay value of y ns corresponds to an asymmetry of $y \times 2$ ns.

The value is positive if the delay from the *PTP* master to the *PTP* slave is longer than in the opposite direction.

2.4 802.1AS

[Time > 802.1AS]

The protocol 802.1AS is a procedure specified in IEEE 802.1AS-2020 that defines how to synchronize time accurately between devices in the network. When you use the protocol 802.1AS over the Ethernet, you can think of the protocol as a profile of IEEE 1588-2019.

With the *Best Master Clock Algorithm*, the devices in the network determine which device has the most accurate time. The devices use the device with the most accurate time as the reference time source (*Grandmaster*). Subsequently, the participating devices synchronize themselves with this reference time source.

The *802.1AS* function has the following specifications:

- In the device, either the *802.1AS* function or the *PTP* function can be enabled.
- If the *SNTP* function and the *802.1AS* function are enabled in the device at the same time, then the *802.1AS* function has priority.
- The *802.1AS* function supports 2 PTP instances, each associated with a *domain ID*.

The menu contains the following dialogs:

- ▶ [802.1AS Global](#)
- ▶ [802.1AS Port](#)
- ▶ [802.1AS Statistics](#)

2.4.1 802.1AS Global

[Time > 802.1AS > Global]

In this dialog, you specify basic settings for the [802.1AS](#) function.

Operation

Operation

Enables/disables the [802.1AS](#) function.

Possible values:

- ▶ [On](#)
The [802.1AS](#) function is enabled.
The device synchronizes its clock using the [802.1AS](#) function.
Consider activating the [802.1AS](#) function for each instance and also on the individual ports.
- ▶ [Off](#) (default setting)
The [802.1AS](#) function is disabled.

Configuration

Sync lower bound [ns]

Specifies the lower threshold value in nanoseconds for the measured time difference between the local clock and the reference time source (*Grandmaster*). If the measured time difference falls below this value, then the device considers its local clock to be synchronized.

Possible values:

- ▶ 0..999999999 (10^9-1) (default setting: 30)

Sync upper bound [ns]

Specifies the upper threshold value in nanoseconds for the measured time difference between the local clock and the reference time source (*Grandmaster*). If the measured time difference exceeds this value, then the device considers its local clock to be unsynchronized.

Possible values:

- ▶ 31..1000000000 (10^9) (default setting: 5000)

Status

This frame displays the synchronization settings of the device for *Instance 0*.

Offset to master [ns]

Displays the measured difference (offset) between the local clock and the reference time source (*Grandmaster*) in nanoseconds. The device calculates the difference from the received time information.

Steps removed

Displays the number of communication paths passed through between the local clock of the device and the reference time source (*Grandmaster*).

When the device operates in the *Slave* role, the value 1 means that the device is connected with the reference time source (*Grandmaster*) directly through one communication path.

Clock identity

Displays the clock identification number of the device.

The device displays the identification number as a byte sequence in hexadecimal notation.

The device identification number consists of the MAC address of the device followed by:

- ▶ 00:01 for *Instance 0*
- ▶ 00:02 for *Instance 1*

Max. offset absolute [ns]

Displays the maximum measured time difference in nanoseconds that has occurred since the device synchronized its local clock with the reference time source (*Grandmaster*).

Is synchronized

Displays if the local clock is synchronized with the reference time source (*Grandmaster*).

If the measured time difference between the local clock and the reference time source (*Grandmaster*) falls below the synchronization lower threshold value, then the device considers its local clock to be synchronized. The device keeps this status until the measured time difference exceeds the synchronization upper threshold value.

You specify the synchronization threshold values in the [Configuration](#) frame.

Grandmaster

This frame displays the criteria that the *Best Master Clock Algorithm* uses when determining the reference time source (*Grandmaster*) for *Instance 0*.

The device uses the *Best Master Clock Algorithm* of PTP to first evaluate the value in the *Priority 1* field of the participating devices. The device with the numerically lowest *Priority 1* value becomes the reference time source (*Grandmaster*). When these values are the same for multiple devices, the algorithm uses the second-highest criterion to make a decision. When these values are also the same for multiple devices, the algorithm uses the third-highest criterion. If these values are also the same for multiple devices, then the numerically lowest *Clock identity* value decides which device becomes the reference time source (*Grandmaster*).

The device lets you influence which device in the network is designated as the reference time source (*Grandmaster*). To do this, modify the value in the *Priority 1* field or the *Priority 2* field in the [Time > 802.1AS > Global](#) frame.

Priority 1

Displays the *priority 1* value for the device that is currently the reference time source (*Grandmaster*).

Clock class

Displays the class of the reference time source (*Grandmaster*). This is a parameter used by the *Best Master Clock Algorithm*.

Clock accuracy

Displays the estimated accuracy of the reference time source (*Grandmaster*). This is a parameter used by the *Best Master Clock Algorithm*.

Clock variance

Displays the variance of the reference time source (*Grandmaster*), also known as the *Offset scaled log variance*. This is a parameter used by the *Best Master Clock Algorithm*.

Priority 2

Displays the *priority 2* value for the device that is currently the reference time source (*Grandmaster*).

Clock identity

Displays the identification number of the reference time source (*Grandmaster*) device.

The device identification number consists of the MAC address of the device followed by:

- ▶ 00:01 for *Instance 0*
- ▶ 00:02 for *Instance 1*

Parent

This frame displays the settings of the directly superior master device for *Instance 0*.

Clock identity

Displays the port identification number of the directly superior master device.

The device identification number consists of the MAC address of the device followed by:

- ▶ 00:01 for *Instance 0*
- ▶ 00:02 for *Instance 1*

Port

Displays the port number of the directly superior master device.

Cumulative rate ratio [ppm]

Displays the measured frequency difference of the local clock in ppm (parts per million) relative to the reference time source (*Grandmaster*).

2.4.2 802.1AS Port

[Time > 802.1AS > Port]

In this dialog, you specify the [802.1AS](#) settings for each instance and on each individual port.

[Instance]

The [802.1AS](#) function supports 2 instances: *Instance 0* and *Instance 1*, each associated with a separate *PTP domain*. The device can be part of multiple *PTP domains*.

You set up each instance separately:

- ▶ *Instance 0* for synchronizing device clock
- ▶ *Instance 1* for the transmission of time synchronization messages

Operation

Operation

Enables/disables the [802.1AS](#) function for the respective instance.

Possible values:

- ▶ *On*
The [802.1AS](#) function is enabled.
The device synchronizes its local clock using the [802.1AS](#) function.
Consider activating the [802.1AS](#) function on the individual ports.
- ▶ *Off* (default setting)
The [802.1AS](#) function is disabled.

Configuration

Priority 1

Specifies the *priority 1* value for the instance.

Possible values:

- ▶ *0..255* (default setting: 248)
Verify that you use the value 255 for a *PTP instance* that is not Grandmaster-capable.

Priority 2

Specifies the *priority 2* value for the instance.

Possible values:

- ▶ *0..255* (default setting: 247)
Verify that you use the value 255 for a *PTP instance* that is not Grandmaster-capable.

Domain number

Specifies the domain number.

If a port is part of the same domain for both *Instance 0* and *Instance 1*, then the dialog displays an error message.

Possible values:

- ▶ **0..127** (default settings: **0** for *Instance 0* and **1** for *Instance 1*)

External port configuration

Activates/deactivates the manual setup of the port roles.

Possible values:

- ▶ **marked**
Manual setup is active.
You can select the desired port roles from the *Desired Role* drop-down list.
- ▶ **unmarked** (default setting)
Manual setup is inactive.
The device auto-negotiates port roles.

Table

For information on how to customize the appearance of the table, see [“Working with tables” on page 16](#).

Port

Displays the port number.

Active

Activates/deactivates the *802.1AS* function on the port.

Possible values:

- ▶ **marked** (default setting)
The *802.1AS* function is active on the port.
On the port, the device synchronizes its clock using the *802.1AS* function.
The prerequisite is that none of the following protocols are active on the port:
 - *Link Aggregation*
- ▶ **unmarked**
The *802.1AS* function is inactive on the port.

Role

Displays the current role that the port operates in within the *802.1AS* domain.

Possible values:

- ▶ **Disabled**
The port is not *802.1AS*-capable.
- ▶ **Master**
The port operates in the *Master* role.

- ▶ *Passive*
The port operates in the *Passive* role.
- ▶ *Slave*
The port operates in the *Slave* role.

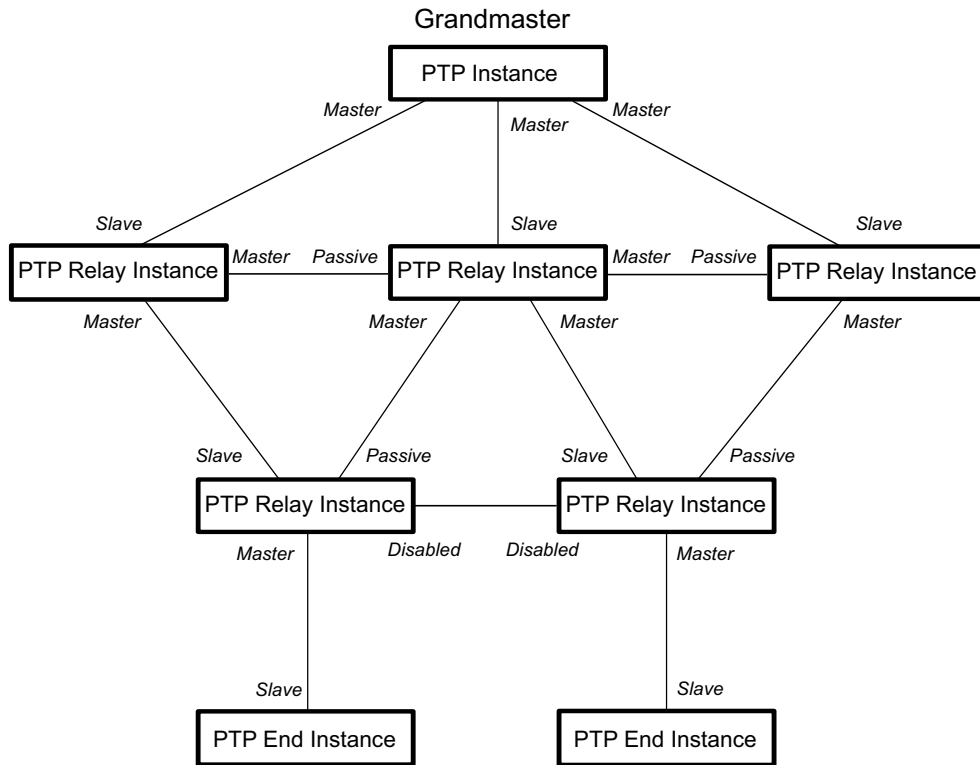

Inspired by: IEEE Std 802.1AS-2020

Desired Role

Specifies the desired role for the port. If the checkbox in the *External port configuration* column is marked, then auto-negotiation of port roles is disabled. You can then manually set the desired port role.

Possible values:

- ▶ *Disabled*
The port is not *802.1AS*-capable.
- ▶ *Master*
The port operates in the *Master* role.
- ▶ *Passive*
The port operates in the *Passive* role.
- ▶ *Slave*
The port operates in the *Slave* role.

AS capable

Displays if the device port and the neighboring are both *802.1AS*-capable and have the *802.1AS* function enabled.

Possible values:

- ▶ **marked**
The connected ports are *802.1AS*-capable and have the *802.1AS* function enabled.
The prerequisites are:
 - The checkbox in the *Measuring delay* column is marked. The device measures the delay (*Peer delay*) on the port.
 - The value you specify in the *Peer delay threshold [ns]* column is higher than the value in the *Peer delay [ns]* column.
- ▶ **unmarked** (default setting)
At least one of the connected ports is not *802.1AS*-capable or does not have the *802.1AS* function enabled.

Initial announce interval [s]

Specifies the interval in seconds at which the port, in the *Master* role, sends *Announce* messages for *802.1AS* topology discovery.

Possible values:

- ▶ **1..2** (default setting: 1)
Assign the same value to every device of an *802.1AS* domain.
- ▶ **-**
The port does not send *Announce* messages.

Settable announce interval [s]

Specifies the interval in seconds at which the port, in the *Master* role, sends *Announce* messages for *802.1AS* topology discovery.

If the checkbox in the *Use settable announce interval* column is marked, then the device uses this value instead of the value specified in the *Initial announce interval [s]* column. During the first synchronization, the device uses the value in the *Initial announce interval [s]* column even if the *Use settable announce interval* checkbox is marked.

Possible values:

- ▶ **1..2** (default setting: 1)
Assign the same value to every device of an *802.1AS* domain.
- ▶ **-**
The port does not transmit *Announce* messages.

Use settable announce interval

Activates/deactivates the use of the interval specified in the *Settable announce interval [s]* column for sending *Announce* messages. The device sends *Announce* messages for *802.1AS* topology discovery.

Possible values:

- ▶ **marked** (default setting)
The device sends *Announce* messages in the interval specified in the *Settable announce interval [s]* column.
- ▶ **unmarked**
The device sends *Announce* messages in the interval specified in the *Initial announce interval [s]* column.

Announce timeout

Specifies the number of *Announce* intervals that the device waits for to receive an *Announce* message on this port from the neighboring port.

Example: In the default setting, where *Settable announce interval [s]* = 1 and *Announce timeout* = 3, the total timeout in seconds is $1 \text{ s} \times 3 = 3 \text{ s}$.

When the specified interval elapses without receiving an *Announce* message, the device tries to find a new path to the reference time source (*Grandmaster*) using the *Best Master Clock Algorithm*. If the device finds a reference time source (*Grandmaster*), then it assigns the *Slave* role to the port through which the new path leads. If the device does not find a reference time source (*Grandmaster*), the device itself becomes the reference time source (*Grandmaster*) and assigns the *Master* role to its ports.

Possible values:

- ▶ 2..10 (default setting: 3)
Assign the same value to each port that belongs to the same *802.1AS* domain.

Initial sync interval [s]

Specifies the interval in seconds at which the port, in the *Master* role, sends *Sync* messages for time synchronization.

Possible values:

- ▶ 0.125 (default setting)
- ▶ 0.250
- ▶ 0.5
- ▶ 1
- ▶ -
The port does not send *Sync* messages.

Settable sync interval [s]

Specifies the interval in seconds at which the port, in the *Master* role, sends *Sync* messages for time synchronization.

If the checkbox in the *Use settable sync interval* column is marked, then the device uses this value instead of the value specified in the *Initial sync interval [s]* column. During the first synchronization, the device uses the value in the *Initial sync interval [s]* column even if the *Use settable sync interval* checkbox is marked.

Possible values:

- ▶ 0.125 (default setting)
- ▶ 0.250
- ▶ 0.5
- ▶ 1
- ▶ -
The port does not send *Sync* messages.

Use settable sync interval

Activates/deactivates the use of the value in the *Settable sync interval [s]* column for sending *Sync* messages.

Possible values:

- ▶ **marked** (default setting)
The device sends *Sync* messages in the interval specified in the *Settable sync interval [s]* column.
- ▶ **unmarked**
The device sends *Sync* messages in the interval specified in the *Initial sync interval [s]* column.

Sync timeout

Specifies the number of *Sync* intervals the device waits for to receive a *Sync* message on this port from the neighboring port.

Example: In the default setting, where *Settable sync interval [s]* = 0.125 and *Sync timeout* = 3, the total timeout in seconds is $0.125 \text{ s} \times 3 = 0.375 \text{ s}$.

When the number of intervals elapses without receiving a *Sync* message, the device tries to find a new path to the reference time source using the *Best Master Clock Algorithm*. If the device finds a reference time source (*Grandmaster*), then it assigns the *Slave* role to the port through which the new path leads. Otherwise, the device itself becomes the reference time source (*Grandmaster*) and assigns the *Master* role to its ports.

Possible values:

- ▶ **2..10** (default setting: 3)
Assign the same value to each port that belongs to the same *802.1AS* domain.

Initial pdelay interval [s]

Specifies the interval in seconds at which the port sends a *Peer delay request* message to the neighboring port to measure the *Peer delay*.

Possible values:

- ▶ **1** (default setting)
- ▶ **2**
- ▶ **4**
- ▶ **8**
- ▶ **-**
The port does not send *Peer delay request* messages.

Settable pdelay interval [s]

Specifies the interval in seconds at which the port sends a *Peer delay request* message to the neighboring port to measure the *Peer delay*.

If the checkbox in the *Use settable pdelay interval* column is marked, then the device uses this value instead of the value specified in the *Initial pdelay interval [s]* column. During the first synchronization, the device uses the value in the *Initial pdelay interval [s]* column even if the *Use settable pdelay interval* checkbox is marked.

Possible values:

- ▶ **1** (default setting)
- ▶ **2**
- ▶ **4**

- ▶ 8
- ▶ -
The port does not send *Peer delay request* messages.

Use settable pdelay interval

Activates/deactivates the use of the value in the *Settable pdelay interval [s]* column for sending *Peer delay request* messages.

Possible values:

- ▶ *marked*
The device sends *Peer delay request* messages in the interval specified in the *Settable pdelay interval [s]* column.
- ▶ *unmarked* (default setting)
The device sends *Peer delay request* messages in the interval specified in the *Initial pdelay interval [s]* column.

Initial GptpCapable interval [s]

Specifies the interval in seconds at which the port sends a message to the neighboring port about the device capability for time synchronization.

Possible values:

- ▶ 1 (default setting)
- ▶ 2
- ▶ 4
- ▶ 8
- ▶ -
The port does not send *gPTP-capable* messages.

Settable GptpCapable interval [s]

Specifies the interval in seconds at which the port sends a message to the neighboring port about the device capability for time synchronization.

If the checkbox in the *Use settable GptpCapable interval* column is marked, the device uses this value instead of the value specified in the *Initial GptpCapable interval [s]* column. During the first synchronization, the device uses the value in the *Initial GptpCapable interval [s]* column even if the *Use settable GptpCapable interval* checkbox is marked.

Possible values:

- ▶ 1 (default setting)
- ▶ 2
- ▶ 4
- ▶ 8
- ▶ -
The port does not send *gPTP-capable* messages.

Use settable GtpCapable interval

Activates/deactivates the use of the value in the *Settable GtpCapable interval [s]* column for sending messages that contain *gPTP-capable* information.

Possible values:

- ▶ *marked*
The device sends *gPTP-capable* messages in the interval specified in the *Settable GtpCapable interval [s]* column.
- ▶ *unmarked* (default setting)
The device sends *gPTP-capable* messages in the interval specified in the *Initial GtpCapable interval [s]* column.

GtpCapable timeout

Specifies the number of *gPTP-capable* intervals that the device waits for to receive a *gPTP-capable* message on this port from the neighboring port.

When the number of intervals elapses without receiving a *gPTP-capable* message, the device assigns the *Disabled* role to the port. The port is no longer *gPTP-capable*.

Possible values:

- ▶ *1..255* (default setting: 9)

Peer delay timeout

Specifies the number of *Peer delay* intervals that the device waits for to receive a *Peer delay* message from the neighboring port.

When the number of intervals elapses without receiving a *Peer delay* message, the device assigns the *Disabled* role to the port. The port is no longer *802.1AS-capable*. See the *AS capable* column.

Possible values:

- ▶ *1..255* (default setting: 9)

Allowed faults

Specifies the number of detected faults above which the device no longer considers the port as *802.1AS-capable*. The device assigns the *Disabled* role to the port.

Examples of such detected faults are:

- The *Peer delay threshold [ns]* value exceeds the upper threshold.
- The calculated *Neighbor rate ratio [ppm]* is invalid.

Possible values:

- ▶ 1..255 (default setting: 9)

Peer delay threshold [ns]

Specifies the upper threshold value for the *Peer delay* in nanoseconds. If the value in the *Peer delay [ns]* column is greater than this value, then the device assigns the *Disabled* role to the port. The port is no longer 802.1AS-capable. See the *AS capable* column.

Possible values:

- ▶ 0..1000000 (10⁶) (default setting: 10000)

Measuring delay

Displays if the device measures the delay (*Peer delay*) on the port.

Possible values:

- ▶ *marked*
The device measures the delay (*Peer delay*) on the port. You find the measured value in the *Peer delay [ns]* column.
- ▶ *unmarked*
The device does not measure the delay (*Peer delay*) on the port.

Peer delay [ns]

Displays the *Peer delay* value in nanoseconds the device measured. The prerequisite is that the checkbox in the *Measuring delay* column is marked.

Asymmetry

Specifies the time difference in nanoseconds between the mean link delay value (*Peer delay [ns]* / 2) and the propagation time from the port to its neighbor.

Possible values:

- ▶ -10000000000..10000000000 (10¹⁰) (default setting: 0)

Neighbor rate ratio [ppm]

Displays the measured frequency difference of the local clock in parts per million relative to the clock in the adjacent device.

2.4.3 802.1AS Statistics

[Time > 802.1AS > Statistics]

This dialog displays information about the number of messages received, sent, or discarded on the ports. The dialog also displays counters that increment every time a timeout event occurred.

[Instance]

The device displays information for each instance separately.

Table

For information on how to customize the appearance of the table, see [“Working with tables” on page 16](#).

Port

Displays the port number.

Received messages

Displays the counters for messages received on the ports.

Sync

Displays the number of *Sync* messages.

Sync follow-up

Displays the number of *Sync follow-up* messages.

Delay request

Displays the number of *Peer delay request* messages.

Delay response

Displays the number of *Peer delay response* messages.

Delay response follow-up

Displays the number of *Peer delay response follow-up* messages.

Announce

Displays the number of *Announce* messages.

Discarded

Displays the number of *Sync* messages that the device discarded on this port. The device discards a *Sync* message for example, in cases where the port does not receive a *Sync follow-up* message for a corresponding *Sync* message.

Sync timeout

Displays the number of times that a *Sync timeout* event occurred on the port. See the *Sync timeout* column in the *Time > 802.1AS > Port* dialog.

Announce timeout

Displays the number of times that the *Announce timeout* event occurred on this port. See the *Announce timeout* column in the *Time > 802.1AS > Port* dialog.

Delay timeout

Displays the number of times that the *Peer delay timeout* event occurred on this port. See the *Peer delay timeout* column in the *Time > 802.1AS > Port* dialog.

Transmitted messages

Displays the counters for messages transmitted on the ports:

Sync

Displays the number of *Sync* messages.

Sync follow-up

Displays the number of *Sync follow-up* messages.

Delay request

Displays the number of *Peer delay request* messages.

Delay response

Displays the number of *Peer delay response* messages.

Delay response follow-up

Displays the number of *Peer delay response follow-up* messages.

Announce

Displays the number of *Announce* messages.

3 Device Security

The menu contains the following dialogs:

- ▶ [User Management](#)
- ▶ [Authentication List](#)
- ▶ [Management Access](#)
- ▶ [Pre-login Banner](#)
- ▶ [SSH Known Hosts](#)

3.1 User Management

[Device Security > User Management]

If users log into the device management with valid login data, then the device lets them have access to its device management.

In this dialog, you manage the users of the local user management. You also specify the following settings here:

- Settings for the login
- Settings for saving the passwords
- Specify policy for valid passwords

The methods that the device uses for the authentication you specify in the [Device Security > Authentication List](#) dialog.

Configuration

This frame lets you specify settings for the login.

Login attempts

Specifies the number of possible consecutive unsuccessful login attempts when the user accesses the device management using the Graphical User Interface or the Command Line Interface.

Note: When accessing the device management using the Command Line Interface through the serial connection, the number of unsuccessful consecutive login attempts is unlimited.

Possible values:

- ▶ `0..5` (default setting: `0`)

If the user makes one more consecutive unsuccessful login attempt, then the device locks access for the user.

The device lets only users with the [administrator](#) authorization remove the lock.

The value `0` deactivates the lock. The user has unlimited attempts to log into the device management.

Min. password length

The device accepts the password if it contains at least the number of characters specified here.

The device checks the password according to this setting, regardless of the setting for the *Policy check* checkbox.

Possible values:

▶ 1..64 (default setting: 6)

Login attempts period (min.)

Displays the time period before the device resets the counter in the *Login attempts* field.

Possible values:

▶ 0..60 (default setting: 0)

Password policy

This frame lets you specify the policy for valid passwords. The device checks every new password and password change according to this policy.

The settings effect the *Password* column. The prerequisite is that the checkbox in the *Policy check* column is marked.

Upper-case characters (min.)

The device accepts the password if it contains at least as many upper-case letters as specified here.

Possible values:

▶ 0..16 (default setting: 1)

The value 0 deactivates this setting.

Lower-case characters (min.)

The device accepts the password if it contains at least as many lower-case letters as specified here.

Possible values:

▶ 0..16 (default setting: 1)

The value 0 deactivates this setting.

Digits (min.)

The device accepts the password if it contains at least as many numbers as specified here.

Possible values:

▶ 0..16 (default setting: 1)

The value 0 deactivates this setting.

Special characters (min.)

The device accepts the password if it contains at least as many special characters as specified here.

Possible values:

- ▶ 0..16 (default setting: 1)

The value 0 deactivates this setting.

Table

Every user requires an active user account to gain access to the device management. The table lets you set up and manage user accounts. To change settings, click the desired parameter in the table and modify the value.

For information on how to customize the appearance of the table, see [“Working with tables” on page 16](#).

Buttons



Add

Opens the [Create](#) window to add a table row.

- In the [User name](#) field, you specify the name of the user account.
Possible values:
 - ▶ Alphanumeric ASCII character string with 1..32 characters



Remove

Removes the selected table row.

User name

Displays the name of the user account.

To add a user account, click the  button.

Active

Activates/deactivates the user account.

Possible values:

- ▶ [marked](#)
The user account is active. The device accepts the login of a user, to the device management, with this user name.
- ▶ [unmarked](#) (default setting)
The user account is inactive. The device rejects the login of a user, to the device management, with this user name.

When one user account exists with the access role [administrator](#), this user account is constantly active.

Password

Specifies the password that the user applies to access the device management using the Graphical User Interface or Command Line Interface.

Displays ***** (asterisks) instead of the password with which the user logs into the device management. To change the password, click the relevant field.

When you specify the password for the first time, the device uses the same password in the [SNMP auth password](#) and [SNMP encryption password](#) columns.

- The device lets you specify different passwords in the [SNMP auth password](#) and [SNMP encryption password](#) columns.
- If you change the password in the current column, then the device also changes the passwords for the [SNMP auth password](#) and [SNMP encryption password](#) columns, but only if they are not individually specified previously.

Possible values:

- ▶ Alphanumeric ASCII character string with 6..64 characters
The device accepts the following characters:
 - a..z
 - A..Z
 - 0..9
 - !#\$%&'()*+,-./:;<=>?@[\\]^_`{|}~

The minimum length of the password is specified in the [Configuration](#) frame. The device differentiates between upper and lower case.

If the checkbox in the [Policy check](#) column is marked, then the device checks the password according to the policy specified in the [Password policy](#) frame.

The device constantly checks the minimum length of the password, even if the checkbox in the [Policy check](#) column is *unmarked*.

Role

Specifies the access role that regulates the access of the user to the individual functions of the device.

Possible values:

- ▶ [unauthorized](#)
The user is blocked, and the device rejects the user login to the device management. Assign this value to temporarily lock the user account. If the device detects an error when another access role is being assigned, then the device assigns this access role to the user account.
- ▶ [guest](#) (default setting)
The user is authorized to monitor the device.
- ▶ [auditor](#)
The user is authorized to monitor the device and to save the log file in the [Diagnostics > Report > Audit Trail](#) dialog.
- ▶ [operator](#)
The user is authorized to monitor the device and to change the settings – with the exception of security settings for device access.
- ▶ [administrator](#)
The user is authorized to monitor the device and to change the settings.

The device assigns the Service Type transferred in the response of a RADIUS server as follows to an access role:

- **Administrative-User:** *administrator*
- **Login-User:** *operator*
- **NAS-Prompt-User:** *guest*

User locked

Unlocks the user account.

Possible values:

- ▶ **marked**
The user account is locked. The user has no access to the device management. If the user makes too many consecutive unsuccessful login attempts, then the device automatically locks the user.
- ▶ **unmarked** (grayed out) (default setting)
The user account is unlocked. The user has access to the device management.

Policy check

Activates/deactivates the password check.

Possible values:

- ▶ **marked**
The password check is activated. When you set up or change the password, the device checks the password according to the policy specified in the *Password policy* frame.
- ▶ **unmarked** (default setting)
The password check is deactivated.

SNMP auth type

Specifies the authentication protocol that the device applies for user access using SNMPv3.

Possible values:

- ▶ **hmacmd5** (default setting)
For this user account, the device uses protocol HMACMD5.
- ▶ **hmacsha**
For this user account, the device uses protocol HMACSHA.

SNMP auth password

Specifies the password that the device applies for user access using SNMPv3.

Displays ***** (asterisks) instead of the password with which the user logs into the device management. To change the password, click the relevant field.

By default, the device uses the same password that you specify in the *Password* column.

- For the current column, the device lets you specify a different password than in the *Password* column.
- If you change the password in the *Password* column, then the device also changes the password for the current column, but only if it is not individually specified.

Possible values:

- ▶ Alphanumeric ASCII character string with 6..64 characters
The device accepts the following characters:
 - a..z
 - A..Z
 - 0..9
 - !#\$%&'()*+,-./:;<=>?@[\\]^_`{|}~

SNMP encryption type

Specifies the encryption protocol that the device applies for user access using SNMPv3.

Possible values:

- ▶ *none*
No encryption.
- ▶ *des* (default setting)
DES encryption
- ▶ *aesCfb128*
AES128 encryption

SNMP encryption password

Specifies the password that the device applies to encrypt user access using SNMPv3.

Displays ***** (asterisks) instead of the password with which the user logs into the device management. To change the password, click the relevant field.

By default, the device uses the same password that you specify in the *Password* column.

- For the current column, the device lets you specify a different password than in the *Password* column.
- If you change the password in the *Password* column, then the device also changes the password for the current column, but only if it is not individually specified.

Possible values:

- ▶ Alphanumeric ASCII character string with 6..64 characters
The device accepts the following characters:
 - a..z
 - A..Z
 - 0..9
 - !#\$%&'()*+,-./:;<=>?@[\\]^_`{|}~

3.2 Authentication List

[Device Security > Authentication List]

In this dialog, you manage the authentication lists. In an authentication list you specify which method the device uses for the authentication. You also have the option to assign pre-defined applications to the authentication lists.

If users log in with valid login data, then the device lets them have access to its device management. The device authenticates the users using the following methods:

- User management of the device
- RADIUS

With the port-based access control according to IEEE 802.1X, if connected end devices log in with valid login data, then the device lets them have access to the network. The device authenticates the end devices using the following methods:

- RADIUS
- IAS (Integrated Authentication Server)

In the default setting the following authentication lists are available:

- `defaultDot1x8021AuthList`
- `defaultLoginAuthList`
- `defaultV24AuthList`

Table

For information on how to customize the appearance of the table, see [“Working with tables” on page 16](#).

Note: If the table does not contain a list, then the access to the device management is only possible using the Command Line Interface through the serial interface of the device. In this case, the device authenticates the user by using the local user management. See the [Device Security > User Management](#) dialog.

Buttons



Add

Opens the [Create](#) window to add a table row.

- In the [Name](#) field, you specify the name of the list.
Possible values:
 - ▶ Alphanumeric ASCII character string with 1..32 characters



Remove

Removes the selected table row.



Allocate applications

Opens the *Allocate applications* window. The window displays the applications that you can designate to the selected list.

- Click and select an item to designate it to the currently selected list.
An application that is already designated to a different list the device designates to the currently selected list, after you click the *Ok* button.
- Click and deselect an item to undo its designation to the currently selected list.
If you deselect the application *WebInterface*, then the connection to the device is lost, after you click the *Ok* button.

Name

Displays the name of the list.

To add a list, click the  button.

Policy 1
Policy 2
Policy 3
Policy 4
Policy 5

Specifies the authentication policy that the device uses for access using the application specified in the *Dedicated applications* column.

The device gives you the option of a fall-back solution. For this, you specify another policy in each of the policy fields. If the authentication with the specified policy is unsuccessful, then the device can use the next policy, depending on the order of the values entered in each policy.

Possible values:

- ▶ *Local* (default setting)
The device authenticates the users by using the local user management. See the *Device Security > User Management* dialog.
You cannot assign this value to the authentication list *defaultDot1x8021AuthList*.
- ▶ *radius*
The device authenticates the users with a RADIUS server in the network. You specify the RADIUS server in the *Network Security > RADIUS > Authentication Server* dialog.
- ▶ *reject*
The device accepts or rejects the user logging into the device management depending on which policy you try first. The following list contains authentication scenarios:
 - If the first policy in the authentication list is *Local* and the device accepts the login credentials of the user, then it logs the user into the device management without attempting the other policies.
 - If the first policy in the authentication list is *Local* and the device denies the login credentials of the user, then it attempts to log the user into the device management using the other policies in the order specified.
 - If the first policy in the authentication list is *radius* and the device rejects a login, then the login is immediately rejected without attempting to log in the user using another policy.
If there is no response from the RADIUS server, then the device attempts to authenticate the user with the next policy.

- If the first policy in the authentication list is *reject*, then the devices immediately rejects the user login without attempting another policy.
- Verify that the authentication list `defaultV24AuthList` contains at least one policy different from *reject*.

▶ *ias*

The device authenticates the end devices logging in using 802.1X with the integrated authentication server (IAS). The integrated authentication server manages the login data in a separate database. See the [Network Security > 802.1X > IAS](#) dialog.

You can only assign this value to the authentication list `defaultDot1x8021AuthList`.

Dedicated applications

Displays the dedicated applications. When users access the device with the relevant application, the device uses the specified policies for the authentication.

To allocate another application to the list or remove the allocation, click the  button. The device lets you assign each application to exactly one list.

Active

Activates/deactivates the list.

Possible values:

▶ *marked* (default setting)

The list is activated. The device uses the policies in this list when users access the device with the relevant application.

▶ *unmarked*

The list is deactivated.

3.3 Management Access

[Device Security > Management Access]

The menu contains the following dialogs:

- ▶ [Server](#)
- ▶ [IP Access Restriction](#)
- ▶ [Web](#)
- ▶ [Command Line Interface](#)
- ▶ [SNMPv1/v2 Community](#)

3.3.1 Server

[Device Security > Management Access > Server]

This dialog lets you set up the server services which enable users or applications to access the management of the device.

The dialog contains the following tabs:

- ▶ [Information]
- ▶ [SNMP]
- ▶ [Telnet]
- ▶ [SSH]
- ▶ [HTTP]
- ▶ [HTTPS]

[Information]

This tab displays as an overview which server services are enabled.

Table

For information on how to customize the appearance of the table, see [“Working with tables” on page 16](#).

SNMPv1

Displays if the server service is active or inactive, which authorizes access to the device using SNMP version 1. See the [SNMP](#) tab.

Possible values:

- ▶ [marked](#)
Server service is active.
- ▶ [unmarked](#)
Server service is inactive.

SNMPv2

Displays if the server service is active or inactive, which authorizes access to the device using SNMP version 2. See the [SNMP](#) tab.

Possible values:

- ▶ [marked](#)
Server service is active.
- ▶ [unmarked](#)
Server service is inactive.

SNMPv3

Displays if the server service is active or inactive, which authorizes access to the device using SNMP version 3. See the [SNMP](#) tab.

Possible values:

- ▶ [marked](#)
Server service is active.
- ▶ [unmarked](#)
Server service is inactive.

Telnet server

Displays if the server service is active or inactive, which authorizes access to the device using Telnet. See the [Telnet](#) tab.

Possible values:

- ▶ [marked](#)
Server service is active.
- ▶ [unmarked](#)
Server service is inactive.

SSH server

Displays if the server service is active or inactive, which authorizes access to the device using Secure Shell (SSH). See the [SSH](#) tab.

Possible values:

- ▶ [marked](#)
Server service is active.
- ▶ [unmarked](#)
Server service is inactive.

HTTP server

Displays if the server service is active or inactive, which authorizes access to the device using the Graphical User Interface through HTTP. See the [HTTP](#) tab.

Possible values:

- ▶ [marked](#)
Server service is active.
- ▶ [unmarked](#)
Server service is inactive.

HTTPS server

Displays if the server service is active or inactive, which authorizes access to the device using the Graphical User Interface through HTTPS. See the [HTTPS](#) tab.

Possible values:

- ▶ [marked](#)
Server service is active.
- ▶ [unmarked](#)
Server service is inactive.

[SNMP]

This tab lets you specify settings for the SNMP agent of the device and to enable/disable access to the device with different SNMP versions.

The SNMP agent enables access to the device management with SNMP-based applications.

Configuration

SNMPv1

Activates/deactivates the access to the device with SNMP version 1.

Possible values:

- ▶ **marked**
SNMP version 1 access is active.
 - You specify the community names in the [Device Security > Management Access > SNMPv1/v2 Community](#) dialog.
- ▶ **unmarked** (default setting)
SNMP version 1 access is inactive.

SNMPv2

Activates/deactivates the access to the device with SNMP version 2.

Possible values:

- ▶ **marked**
SNMP version 2 access is active.
 - You specify the community names in the [Device Security > Management Access > SNMPv1/v2 Community](#) dialog.
- ▶ **unmarked** (default setting)
SNMP version 2 access is inactive.

SNMPv3

Activates/deactivates the access to the device with SNMP version 3.

Possible values:

- ▶ **marked** (default setting)
Access is activated.
- ▶ **unmarked**
Access is deactivated.

Network management systems like Industrial HiVision use this protocol to communicate with the device.



UDP port

Specifies the number of the UDP port on which the SNMP agent receives requests from clients.

Possible values:

- ▶ **1..65535 (2¹⁶-1)** (default setting: 161)
Exception: Port 2222 is reserved for internal functions.

To enable the SNMP agent to use the new port after a change, you proceed as follows:

- Click the  button.
- Select in the *Basic Settings > Load/Save* dialog the active configuration profile.
- Click the  button to save the current settings.
- Restart the device.

SNMPOver802

Activates/deactivates the access to the device through SNMP over IEEE 802.

Possible values:

- ▶ *marked*
Access is activated.
- ▶ *unmarked* (default setting)
Access is deactivated.

[Telnet]

This tab lets you enable/disable the Telnet server in the device and specify its settings.

The Telnet server enables access to the device management remotely through the Command Line Interface. Telnet connections are unencrypted.

Operation

Telnet server

Enables/disables the Telnet server.

Possible values:

- ▶ *On* (default setting)
The Telnet server is enabled.
The access to the device management is possible through the Command Line Interface using an unencrypted Telnet connection.
- ▶ *off*
The Telnet server is disabled.

Note: If the *SSH* server is disabled and you also disable the *Telnet* server, then the access to the Command Line Interface is only possible through the serial interface of the device.

Configuration

TCP port

Specifies the number of the TCP port on which the device receives Telnet requests from clients.

Possible values:

- ▶ 1..65535 ($2^{16}-1$) (default setting: 23)
Exception: Port 2222 is reserved for internal functions.

The server restarts automatically after the port is changed. Existing connections remain in place.

Connections

Displays how many Telnet connections are currently established to the device.

Connections (max.)

Specifies the maximum number of Telnet connections to the device that can be set up simultaneously.

Possible values:

- ▶ 1..5 (default setting: 5)

Session timeout [min]

Specifies the timeout in minutes. After the device has been inactive for this time, it ends the session for the user logged into the device management.

A change in the value takes effect the next time a user logs into the device management.

Possible values:

- ▶ 0
Deactivates the function. The connection remains established in the case of inactivity.
- ▶ 1..160 (default setting: 5)

[SSH]

This tab lets you enable/disable the SSH server in the device and specify its settings required for SSH. The server works with SSH version 2.

The SSH server enables access to the device management remotely through the Command Line Interface. SSH connections are encrypted.

The SSH server identifies itself to the clients using its public RSA key. When first setting up the connection, the client program displays the user the fingerprint of this key. The fingerprint contains a Base64-coded character sequence that is easy to check. When you make this character sequence available to the users through a reliable channel, they have the option to compare both fingerprints. If the character sequences match, then the client is connected to the correct server.

The device lets you generate the private and public keys (host keys) required for RSA directly in the device. As an alternative, transfer your own host key in PEM format onto the device.

As an alternative, the device lets you load the RSA key (host key) from an external memory during the system startup. You activate this function in the [Basic Settings > External Memory](#) dialog, [SSH key auto upload](#) column.

Operation

SSH server

Enables/disables the SSH server.

Possible values:

▶ [On](#) (default setting)

The SSH server is enabled.

The access to the device management is possible through the Command Line Interface using an encrypted SSH connection.

You can start the server only if there is an RSA signature in the device.

▶ [Off](#)

The SSH server is disabled.

When you disable the SSH server, the existing connections remain established. However, the device helps prevent new connections from being set up.

Note: If the [Telnet](#) server is disabled and you also disable the [SSH](#) server, then the access to the Command Line Interface is only possible through the serial interface of the device.

Configuration

TCP port

Specifies the number of the TCP port on which the device receives SSH requests from clients.

Possible values:

▶ [1..65535 \(2¹⁶-1\)](#) (default setting: [22](#))

Exception: Port [2222](#) is reserved for internal functions.

The server restarts automatically after the port is changed. Existing connections remain in place.

Sessions

Displays how many SSH connections are currently established to the device.

Sessions (max.)

Specifies the maximum number of SSH connections to the device that can be set up simultaneously.

Possible values:

- ▶ [1..5](#) (default setting: 5)

Session timeout [min]

Specifies the timeout in minutes. After the user logged into the device management has been inactive for this time, the device ends the connection.

A change in the value takes effect the next time a user logs into the device management.

Possible values:

- ▶ [0](#)
Deactivates the function. The connection remains established in the case of inactivity.
- ▶ [1..160](#) (default setting: 5)

Signature

RSA present

Displays if an RSA host key is present in the device.

Possible values:

- ▶ [marked](#)
A key is present.
- ▶ [unmarked](#)
No key is present.

Create

Generates a host key in the device. The prerequisite is that the [SSH](#) server is disabled.

Length of the key generated:

- 2048 bit (RSA)

To get the SSH server to use the generated host key, restart the SSH server.

As an alternative, transfer your own host key in PEM format onto the device. See the [Key import](#) frame.

Delete

Removes the host key from the device. The prerequisite is that the SSH server is disabled.

Oper status

Displays if the device currently generates a host key.

It is possible that another user triggered this action.

Possible values:

- ▶ *rsa*
The device currently generates an RSA host key.
- ▶ *none*
The device does not generate a host key.

Fingerprint

The fingerprint is an easy to verify string that uniquely identifies the host key of the SSH server.

After importing a new host key, the device continues to display the existing fingerprint until you restart the server.

Fingerprint type



Specifies which fingerprint the *RSA fingerprint* field displays.

Possible values:

- ▶ *md5*
The *RSA fingerprint* field displays the fingerprint as hexadecimal MD5 hash.
- ▶ *sha256* (default setting)
The *RSA fingerprint* field displays the fingerprint as Base64-coded SHA256 hash.

RSA fingerprint

Displays the fingerprint of the public host key of the SSH server.

When you change the settings in the *Fingerprint type* field, click afterwards the  button and then the  button to update the display.

Key import

URL

Specifies the path and file name of your own RSA host key.

The device accepts the RSA key if it has the following key length:

- 2048 bit (RSA)

The device gives you the following options for transferring the file onto the device:

- Import from the PC
When the file is located on your PC or on a network drive, drag and drop it onto the  area.
As an alternative, click in the area to select the file.
- Import from an FTP server
This option is not recommended if you transmit data over untrusted networks.
When the file is on an FTP server, specify the URL for the file in the following form:
ftp://<user>:<password>@<IP address>[:port]/<file name>

- Import from a TFTP server
This option is not recommended if you transmit data over untrusted networks.
When the file is on a TFTP server, specify the URL for the file in the following form:
tftp://<IP address>/<path>/<file name>
- Import from an SCP or SFTP server
When the file is on an SCP or SFTP server, specify the URL for the file in the following form:
 - ▶ scp:// or sftp://<IP address>/<path>/<file name>
Click the *Start* button to open the *Credentials* window. In this window, you enter the *User name* and *Password* to log into the server.
 - ▶ scp:// or sftp://<user>:<password>@<IP address>/<path>/<file name>
Remember to set up the SCP or SFTP server as an SSH known host before the device accesses the server for the first time. See the *Device Security > SSH Known Hosts* dialog.

Start

Transfers the file specified in the *URL* field onto the device.

For the changes to take effect after transferring a digital certificate onto the device, disable and re-enable the *SSH server* function. See the *Operation* frame.

[HTTP]

This tab lets you enable/disable the Hypertext Transfer Protocol (HTTP) for the web server and specify the settings required for HTTP.

The web server provides the Graphical User Interface through an unencrypted HTTP connection. For security reasons, disable the Hypertext Transfer Protocol (HTTP) and use the Hypertext Transfer Protocol Secure (HTTPS) instead.

The device supports up to 10 simultaneous connections using HTTP or HTTPS.

Note: If you change the settings in this tab and click the button, then the device ends the session and disconnects every opened connection. To continue working with the Graphical User Interface, log in again.

Operation

HTTP server

Enables/disables the *HTTP* function for the web server.

Possible values:

- ▶ *On* (default setting)
The *HTTP* function is enabled.
The access to the device management is possible through an unencrypted *HTTP* connection. When the *HTTPS* function is also enabled, the device automatically redirects the request for a *HTTP* connection to an encrypted *HTTPS* connection.
- ▶ *Off*
The *HTTP* function is disabled.
When the *HTTPS* function is enabled, the access to the device management is possible through an encrypted *HTTPS* connection.

Note: If the *HTTP* and *HTTPS* functions are disabled, then you can enable the *HTTP* function using the Command Line Interface command `http server` to get to the Graphical User Interface.

Configuration

TCP port

Specifies the number of the TCP port on which the web server receives HTTP requests from clients.

Possible values:

- ▶ **1..65535** ($2^{16}-1$) (default setting: **80**)
Exception: Port **2222** is reserved for internal functions.

[HTTPS]

This tab lets you enable/disable the Hypertext Transfer Protocol Secure(HTTPS) for the web server and specify the settings required for HTTPS.

The web server provides the Graphical User Interface through an encrypted HTTP connection.

A digital certificate is required for the encryption of the HTTP connection. The device lets you generate this digital certificate yourself or to transfer an existing digital certificate onto the device.

The device supports up to 10 simultaneous connections using HTTP or HTTPS.

Note: If you change the settings in this tab and click the button, then the device ends the session and disconnects every opened connection. To continue working with the Graphical User Interface, log in again.

Operation

HTTPS server

Enables/disables the *HTTPS* function for the web server.

Possible values:

- ▶ **On** (default setting)
The *HTTPS* function is enabled.
The access to the device management is possible through an encrypted *HTTPS* connection.
When there is no digital certificate present, the device generates a digital certificate before it enables the *HTTPS* function.
- ▶ **Off**
The *HTTPS* function is disabled.
When the *HTTP* function is enabled, the access to the device management is possible through an unencrypted *HTTP* connection.

Note: If the *HTTP* and *HTTPS* functions are disabled, then you can enable the *HTTPS* function using the Command Line Interface command `https server` to get to the Graphical User Interface.

Configuration

TCP port

Specifies the number of the TCP port on which the web server receives HTTPS requests from clients.

Possible values:

- ▶ [1..65535 \(2¹⁶-1\)](#) (default setting: [443](#))
Exception: Port [2222](#) is reserved for internal functions.

Certificate

If the device uses a digital certificate not signed by a Certification Authority (CA) known to the web browser, then the web browser may display a warning message before loading the Graphical User Interface.

To address the warning, you have the following possibilities:

- Transfer a digital certificate onto the device whose Certification Authority (CA) is known to your web browser. This may additionally require you to make the Certification Authority (CA) known to your web browser or operating system.
- As a workaround, you can also add an exception rule for the existing device certificate in your web browser.

Present

Displays if a digital certificate is present in the device.

Possible values:

- ▶ [marked](#)
A digital certificate is present.
- ▶ [unmarked](#)
The digital certificate has been removed.

Create

Generates a digital certificate in the device.

Until restarting the web server uses the previous certificate.

To get the web server to use the newly generated digital certificate, restart the web server. Restarting the web server is possible only through the Command Line Interface.

As an alternative, transfer your own digital certificate onto the device. See the [Certificate import](#) frame.

Delete

Deletes the digital certificate.

Until restarting the web server uses the previous certificate.

Oper status

Displays if the device currently generates or deletes a digital certificate.

It is possible that another user has triggered the action.

Possible values:

- ▶ *none*
The device does currently not generate or delete a digital certificate.
- ▶ *delete*
The device currently deletes a digital certificate.
- ▶ *generate*
The device currently generates a digital certificate.

Fingerprint

The fingerprint is an easily verified hexadecimal number sequence that uniquely identifies the digital certificate of the HTTPS server.

After importing a new digital certificate, the device displays the current fingerprint until you restart the server.

Fingerprint type

Specifies which fingerprint the *Fingerprint* field displays.

Possible values:

- ▶ *sha1*
The *Fingerprint* field displays the SHA1 fingerprint of the digital certificate.
- ▶ *sha256* (default setting)
The *Fingerprint* field displays the SHA256 fingerprint of the digital certificate.

Fingerprint

Hexadecimal character sequence of the digital certificate used by the server.

When you change the settings in the *Fingerprint type* field, click afterwards the ✓ button and then the  button to update the display.

Certificate import

URL

Specifies the path and file name of the digital certificate.

The device accepts digital certificates with the following properties:

- X.509 format
- .PEM file name extension

- Base64-coded and enclosed by the lines
 - -----BEGIN PRIVATE KEY-----
 - ...
 - END PRIVATE KEY-----
 - or
 - -----BEGIN CERTIFICATE-----
 - ...
 - END CERTIFICATE-----
- RSA key with 2048 bit length

The device gives you the following options for transferring the file onto the device:

- Import from the PC

When the file is located on your PC or on a network drive, drag and drop it onto the  area. As an alternative, click in the area to select the file.
- Import from an FTP server

This option is not recommended if you transmit data over untrusted networks. When the file is on an FTP server, specify the URL for the file in the following form:
`ftp://<user>:<password>@<IP address>[:port]/<path>/<file name>`
- Import from a TFTP server

This option is not recommended if you transmit data over untrusted networks. When the file is on a TFTP server, specify the URL for the file in the following form:
`tftp://<IP address>/<path>/<file name>`
- Import from an SCP or SFTP server

When the file is on an SCP or SFTP server, specify the URL for the file in the following form:

 - `scp:// or sftp://<IP address>[:port]/<path>/<file name>`
 Click the *Start* button to open the *Credentials* window. In this window, you enter the *User name* and *Password* to log into the server.
 - `scp:// or sftp://<user>:<password>@<IP address>[:port]/<path>/<file name>`

Remember to set up the SCP or SFTP server as an SSH known host before the device accesses the server for the first time. See the *Device Security > SSH Known Hosts* dialog.

Start

Transfers the file specified in the *URL* field onto the device.

For the changes to take effect after transferring a digital certificate onto the device, disable and re-enable the *HTTPS server* function. See the *Operation* frame.

3.3.2 IP Access Restriction

[Device Security > Management Access > IP Access Restriction]

This dialog lets you restrict access to the device management from a specific IP address range for selected applications.

- If the function is disabled, then access to the device management is unrestricted. Everyone can access the device management from any IP address using any application.
- If the function is enabled, then access is restricted. Everyone can access the device management only under the following conditions:
 - At least one rule is active.
and
 - You access the device with a permitted application from a permitted IP address range specified in the rule.

Operation

Operation

Enables/disables the *IP Access Restriction* function.

Possible values:

▶ *On*

The *IP Access Restriction* function is enabled.

The access to the device management is restricted.

Note: Before you enable the function, verify that the table contains at least one active rule that grants you access to the device management. Otherwise, access to the device management is only possible using the Command Line Interface through the serial connection.

▶ *Off* (default setting)

The *IP Access Restriction* function is disabled.

Table

You have the option of defining up to 16 table rows and activating them separately.

For information on how to customize the appearance of the table, see [“Working with tables” on page 16](#).

Buttons



Add

Adds a table row.



Remove

Removes the selected table row.

Index

Displays the index number to which the table row relates. The device automatically assigns the value when you add a table row.

When you delete a table row, this leaves a gap in the numbering. When you add a table row, the device fills the first gap.

Possible values:

- ▶ 1..16

Address

Specifies the IP address of the network from which you allow the access to the device management. You specify the network range in the *Netmask* column.

Possible values:

- ▶ Valid IPv4 address (default setting: 0.0.0.0)

Netmask

Specifies the range of the network specified in the *Address* column.

Possible values:

- ▶ Valid netmask (default setting: 0.0.0.0)
Example: To restrict access from a single IP address, specify the value as 255.255.255.255.

HTTP

Activates/deactivates the HTTP access.

Possible values:

- ▶ *marked* (default setting)
HTTP access is active. Access is possible from the adjacent IP address range.
- ▶ *unmarked*
HTTP access is inactive.

HTTPS

Activates/deactivates the HTTPS access.

Possible values:

- ▶ *marked* (default setting)
HTTPS access is active. Access is possible from the adjacent IP address range.
- ▶ *unmarked*
HTTPS access is inactive.

SNMP

Activates/deactivates the SNMP access.

Possible values:

- ▶ *marked* (default setting)
SNMP access is active. Access is possible from the adjacent IP address range.
- ▶ *unmarked*
SNMP access is inactive.

Telnet

Activates/deactivates the Telnet access.

Possible values:

- ▶ **marked** (default setting)
Telnet access is active. Access is possible from the adjacent IP address range.
- ▶ **unmarked**
Telnet access is inactive.

SSH

Activates/deactivates the SSH access.

Possible values:

- ▶ **marked** (default setting)
SSH access is active. Access is possible from the adjacent IP address range.
- ▶ **unmarked**
SSH access is inactive.

Modbus TCP

Activates/deactivates the access to the *Modbus TCP* server.

Possible values:

- ▶ **marked** (default setting)
Modbus TCP access is active. Access is possible from the adjacent IP address range.
- ▶ **unmarked**
Modbus TCP access is inactive.

EtherNet/IP

Activates/deactivates the access to the *EtherNet/IP* server.

Possible values:

- ▶ **marked** (default setting)
Ethernet/IP access is active. Access is possible from the adjacent IP address range.
- ▶ **unmarked**
Ethernet/IP access is inactive.

PROFINET

Activates/deactivates the access to the *PROFINET* server.

Possible values:

- ▶ **marked** (default setting)
PROFINET access is active. Access is possible from the adjacent IP address range.
- ▶ **unmarked**
PROFINET access is inactive.

Active

Activates/deactivates the table row.

Possible values:

- ▶ **marked** (default setting)
The table row is active. The device restricts the access to the device management from the specified IP address range for the selected applications.
- ▶ **unmarked**
The table row is inactive. The device does not restrict access to the device management from the specified IP address range for the selected applications.

3.3.3 Web

[Device Security > Management Access > Web]

In this dialog, you specify settings for the Graphical User Interface.

Configuration

Web interface session timeout [min]

Specifies the timeout in minutes. After the device has been inactive for this time, it ends the session for the user logged into the device management.

Possible values:

▶ 0..160 (default setting: 5)

The value 0 deactivates the function, and the user remains logged in when inactive.

3.3.4 Command Line Interface

[Device Security > Management Access > CLI]

In this dialog, you specify settings for the Command Line Interface. For further information about the Command Line Interface, see the “Command Line Interface” reference manual.

The dialog contains the following tabs:

- ▶ [Global]
- ▶ [Login banner]

[Global]

This tab lets you change the prompt in the Command Line Interface and specify the automatic closing of sessions through the serial interface when they have been inactive.

The device has the following serial interfaces.

- USB-C interface

Configuration

Login prompt

Specifies the character string that the device displays in the Command Line Interface at the start of every command line.

Possible values:

- ▶ Alphanumeric ASCII character string with 0..128 characters (0x20..0x7E) including space characters
- Wildcards
- %d date
 - %i IP address
 - %m MAC address
 - %p product name
 - %t time
- Default setting: (GRS)

Changes to this setting are immediately effective in the active Command Line Interface session.

Serial interface timeout [min]

Specifies the time in minutes after which the device automatically closes the session of an inactive user logged into the device management with the Command Line Interface through the serial interface.

Possible values:

- ▶ 0..160 (default setting: 5)
- The value 0 deactivates the function, and the user remains logged into the device management when inactive.

A change in the value takes effect the next time a user logs into the device management.

For the *Telnet* server and the *SSH* server, you specify the timeout in the *Device Security > Management Access > Server* dialog.

[Login banner]

In this tab you replace the start screen of the Command Line Interface with your own text.

In the default setting, the start screen displays information about the device, such as the software version and the device settings. With the function in this tab, you deactivate this information and replace it with an individually specified text.

To display your own text in the Command Line Interface and in the Graphical User Interface before the login, you use the *Device Security > Pre-login Banner* dialog.

Operation

Operation

Enables/disables the *Login banner* function.

Possible values:

- ▶ *On*
The *Login banner* function is enabled.
The device displays the text information specified in the *Banner text* field to the users that log into the device management through the Command Line Interface.
- ▶ *Off* (default setting)
The *Login banner* function is disabled.
The start screen displays information about the device. The text information in the *Banner text* field is kept.

Banner text

Banner text

Specifies the character string that the device displays in the Command Line Interface at the start of every session.

Possible values:

- ▶ Alphanumeric ASCII character string with 0..1024 characters (0x20..0x7E) including space characters
- ▶ <Tab>
- ▶ <Line break>

3.3.5 SNMPv1/v2 Community

[Device Security > Management Access > SNMPv1/v2 Community]

In this dialog, you specify the community name for SNMPv1/v2 applications.

Applications send requests using SNMPv1/v2 with a community name in the SNMP data packet header. Depending on the community name (see [Community](#) column), the application gets *read-only* authorization or *read and write* authorization.

You activate the access to the device using SNMPv1/v2 in the [Device Security > Management Access > Server](#) dialog.

Table

For information on how to customize the appearance of the table, see [“Working with tables” on page 16](#).

Community

Displays the authorization for SNMPv1/v2 applications to the device.

Possible values:

- ▶ **Write**
For requests with the community name entered, the application receives *read and write* authorization.
- ▶ **Read**
For requests with the community name entered, the application receives *read-only* authorization.

Name

Specifies the community name for the adjacent authorization.

Possible values:

- ▶ Alphanumeric ASCII character string with 0..64 characters
The device accepts the following characters:
 - <space>
 - 0..9
 - a..z
 - A..Z
 - !"#%&'()*+,-./:;<=>?@[\\]^_`{|}~**private** (default setting for *read and write* authorization)
public (default setting for *read-only* authorization)

3.4 Pre-login Banner

[Device Security > Pre-login Banner]

This dialog lets you display a greeting or information text to users before they log into the device management.

The users see this text in the login dialog of the Graphical User Interface and of the Command Line Interface. Users logging into the device management with SSH see the text - regardless of the client used - before or during the login.

To display the text only in the Command Line Interface, use the settings in the [Device Security > Management Access > CLI](#) dialog.

Operation

Operation

Enables/disables the [Pre-login Banner](#) function.

Using the [Pre-login Banner](#) function, the device displays a greeting or information text in the login dialog of the Graphical User Interface and of the Command Line Interface.

Possible values:

- ▶ [On](#)
The [Pre-login Banner](#) function is enabled.
The device displays the text specified in the [Banner text](#) field in the login dialog.
- ▶ [Off](#) (default setting)
The [Pre-login Banner](#) function is disabled.
The device does not display a text in the login dialog. When you enter a text in the [Banner text](#) field, the device saves this text.

Banner text

Banner text

Specifies information text that the device displays in the login dialog of the Graphical User Interface and of the Command Line Interface.

Possible values:

- ▶ Alphanumeric ASCII character string with 0..512 characters
(`0x20..0x7E`) including space characters
- ▶ `<Tab>`
- ▶ `<Line break>`

3.5 SSH Known Hosts

[Device Security > SSH Known Hosts]

The device only permits SSH-based connections from or to remote servers that are known to the device. In the state on delivery, no remote server is set up as a known host on the device.

In this dialog, you make the remote servers known by their public key fingerprints. You can set up a maximum of 50 public key fingerprints. The device verifies the identity of the remote server by comparing the public key fingerprint stored on the device with the fingerprint calculated from the public key which the server actually sent. If the calculated public key fingerprint does not match the stored public key fingerprint, the device terminates the connection.

If a remote server has several keys set up, for different encryption algorithms, add each of the public key fingerprints as a separate item.

Note: Verify that the public key fingerprints you store on the device is from a trustworthy source, the SSH server administrator, for example.

Table

For information on how to customize the appearance of the table, see [“Working with tables” on page 16](#).

Buttons



Add

Opens the [Create](#) window to add a table row.

- ▶ In the [Index](#) field, you specify the index number.
Possible values:
 - 1..50
The device lets you specify up to 50 known hosts.
- ▶ In the [Address](#) field, you specify the address of the server. If the server can be accessed using both an IP address and a DNS name, then add a separate table row for each address type.
Possible values:
 - Valid IPv4 address
 - Valid IPv6 address
 - DNS hostname

- ▶ In the *Key fingerprint* field, you specify the public key fingerprint of the server. You can find out the public key fingerprint of the server, for example, as follows:
 - from the administrator of a known SSH server
 - from the error message following an unsuccessful software update in the *Software* dialog due to the mismatch between the public key fingerprint stored in the device and the fingerprint calculated from the public key which the server actually sent

Possible values:

- Base64-coded SHA256 hash sequence with a length of 43 or 44 characters

- ▶ In the *Key type* field, you specify the algorithm that was used for generating the public key of the server. You can find out the *Key type* value simultaneously and through the same method you used to obtain the public key fingerprint.

If you accidentally select a different algorithm, then the device cannot identify the public key using the public key fingerprint.

Possible values:

- *dsa*
- *rsa*
- *ecdsa*
- *ed25519*



Remove

Removes the selected table row.

Index

Displays the index number to which the table row relates. You specify the index number when you add a table row.

Address

Displays the address of the server.

Possible values:

- ▶ Valid IPv4 address
- ▶ Valid IPv6 address
- ▶ DNS hostname

Key fingerprint

Specifies the public key fingerprint of the server.

Possible values:

- ▶ Base64-coded SHA256 hash sequence with a length of 43 or 44 characters
To modify the public key fingerprint, first unmark the checkbox in the *Active* column.

Key type

Displays the algorithm that was used for generating the public key of the server.

Possible values:

- ▶ *dsa*
- ▶ *rsa*
- ▶ *ecdsa*
- ▶ *ed25519*

Active

Activates/deactivates the table row.

Possible values:

▶ **marked** (default setting)

The table row is active.

The device considers the server set up in this table row to be known. When you transfer a file from an external server onto the device or vice versa, the device verifies the identity of the external server based on this public key fingerprint.

▶ **unmarked**

The table row is inactive.

The device considers the server set up in this table row to be unknown. When you transfer a file from an external server onto the device or vice versa, the device terminates the connection to this server.

4 Network Security

The menu contains the following dialogs:

- ▶ [Network Security Overview](#)
- ▶ [Port Security](#)
- ▶ [802.1X](#)
- ▶ [RADIUS](#)
- ▶ [DoS](#)
- ▶ [ACL](#)

4.1 Network Security Overview

[Network Security > Overview]

This dialog displays an overview over the network security rules used in the device.

Overview

The top level displays:

- The ports to which a network security rule is assigned
- The VLANs to which a network security rule is assigned

The subordinate levels display:

- The set-up [ACL](#) rules
See the [Network Security > ACL](#) dialog.

Buttons



Displays a text field to search for a keyword. When you enter a character or string, the overview displays only items related to this keyword.



Collapses the levels. The overview then displays only the first level of the items.



Expands the levels. The overview then displays every level of the items.



Expands the current item and displays the items of the next lower level.



Collapses the item and hides the items of the underlying levels.

4.2 Port Security

[Network Security > Port Security]

The device lets you forward only data packets from desired senders on a port. When the *Port Security* function is enabled, the device checks the VLAN ID and MAC address of the sender before it forwards a data packet. The device discards data packets from not desired senders and logs this event.

In this dialog, a *Wizard* window helps you associate the ports with the address of one or more desired senders. In the device, these addresses are known as *static entries*. To view the specified static addresses, select the relevant port and click the  button.

To simplify the setup process, the device lets you record the address of the desired senders automatically. The device “learns” the addresses by evaluating the received data packets. In the device, these addresses are known as *dynamic entries*. When a user-defined upper limit has been reached (*Dynamic limit*), the device stops the “learning” on the relevant port. The device forwards only the data packets of the senders already registered on the port. When you adapt the upper limit to the number of expected senders, you thus make *MAC Flooding* attacks more difficult.

Note: With the automatic recording of the *dynamic entries*, the device constantly discards the first data packet from unknown senders. Using this first data packet, the device checks if the upper limit has been reached. The device records the addresses until the upper limit is reached. Afterwards, the device forwards data packets that it receives on the relevant port from this sender.

Operation

Operation

Enables/disables the *Port Security* function in the device.

Possible values:

- ▶ *On*
 The *Port Security* function is enabled.
 The device checks the VLAN ID and the source MAC address before it forwards a data packet. The device forwards a received data packet only if the VLAN and the source MAC address of the data packet are desired on the relevant port. For this setting to take effect, you also activate the *Port Security* function on the relevant ports.
- ▶ *Off* (default setting)
 The *Port Security* function is disabled.
 The device forwards every received data packet without checking the source address.

Configuration

Auto-disable

Activates/deactivates the *Auto-Disable* function for *Port Security* in the device.

Possible values:

- ▶ **marked**
The *Auto-Disable* function for *Port Security* is active.
Also mark the checkbox in the *Auto-disable* column for the relevant ports.
The device disables the port and optionally sends an SNMP trap when one of the following events occurs:
 - The device registers at least one address of a sender that is not desired on the port.
 - The device registers more addresses than specified in the *Dynamic limit* column.
- ▶ **unmarked** (default setting)
The *Auto-Disable* function for *Port Security* is inactive.

Table

For information on how to customize the appearance of the table, see “[Working with tables](#)” on [page 16](#).

Buttons



Opens the *Wizard* window that helps you associate the ports with the address of one or more desired senders. See “[[Wizard: Port security](#)]” on [page 146](#).

Port

Displays the port number.

Active

Activates/deactivates the *Port Security* function on the port.

Possible values:

- ▶ **marked**
The device checks every data packet received on the port and forwards it only if the source address of the data packet is desired. Also enable the *Port Security* function in the *Operation* frame.
- ▶ **unmarked** (default setting)
The device forwards every data packet received on the port without checking the source address.

Note: When you operate the device as an active participant within an *MRP* ring, we recommend that you unmark the checkbox for the ring ports.

Auto-disable

Activates/deactivates the *Auto-Disable* function for *Port Security* on the port.

Possible values:

- ▶ **marked** (default setting)
The *Auto-Disable* function is active on the port.
The device disables the port and optionally sends an SNMP trap when one of the following events occurs:
 - The device registers at least one address of a sender that is not desired on the port.
 - The device registers more addresses than specified in the *Dynamic limit* column.The *Link status* LED for the port flashes 3 × per period. This restriction makes *MAC Spoofing* attacks more difficult.
The prerequisite is that in the *Configuration* frame the *Auto-disable* checkbox is marked.
 - The *Diagnostics > Ports > Auto-Disable* dialog displays which ports are currently disabled due to the parameters being exceeded.
 - After a waiting period, the *Auto-Disable* function enables the port again automatically. For this you go to the *Diagnostics > Ports > Auto-Disable* dialog and specify a waiting period for the relevant port in the *Reset timer [s]* column.
- ▶ **unmarked**
The *Auto-Disable* function is inactive on the port.

Send trap

Activates/deactivates the sending of SNMP traps when the device discards a data packet from an undesired sender on the port.

Possible values:

- ▶ **marked**
The sending of SNMP traps is active. The prerequisite is that in the *Diagnostics > Status Configuration > Alarms (Traps)* dialog the *Alarms (Traps)* function is enabled and at least one trap destination is specified.
If the device discards data packets from a sender that is not desired on the port, then the device sends an SNMP trap.
- ▶ **unmarked** (default setting)
The sending of SNMP traps is inactive.

Trap interval [s]

Specifies the delay time in seconds that the device waits after sending an SNMP trap before sending the next SNMP trap.

Possible values:

- ▶ **0..3600** (default setting: 0)

The value 0 deactivates the delay time.

Dynamic limit

Specifies the upper limit for the number of automatically registered addresses (*dynamic entries*). When the upper limit is reached, the device stops “learning” on this port.

Adjust the value to the number of expected senders.

If the port registers more addresses than specified here, then the *Auto-Disable* function disables the port. The prerequisite is that you mark the checkbox in the *Auto-disable* column and the *Auto-disable* checkbox in the *Configuration* frame.

Possible values:

- ▶ 0
No automatic registering of addresses on this port.
- ▶ 1..600 (default setting: 600)

Static limit

Specifies the upper limit for the number of addresses associated with the port using the *Wizard* window (*static entries*).

Possible values:

- ▶ 0
No association possible between the port and a desired sender. Only specify this value if you specify a value > 0 in the *Dynamic limit* column.
- ▶ 1..64 (default setting: 64)

Dynamic entries

Displays the number of addresses that the device has automatically registered.

Static MAC entries

Displays the number of MAC addresses associated with the port.

Last violating VLAN ID/MAC

Displays the VLAN ID and MAC address of an undesired sender whose data packets the device last discarded on this port.

Sent traps

Displays the number of discarded data packets on this port that caused the device to send an SNMP trap.

[Wizard: Port security]

The *Wizard* window helps you associate the ports with the address of one or more desired senders.

The *Wizard* window guides you through the following steps:

- [Select port](#)
- [MAC addresses](#)

Note: The device saves the addresses associated with the port until you deactivate the *Port Security* function on the relevant port or disable the *Port Security* function in the device.

After closing the *Wizard* window, click the  button to save your settings.

Select port

Port

Specifies the port that you associate with the address of desired senders in the next step.

MAC addresses

Static entries (x/y)

Displays the number of addresses associated with the port using the *Wizard* window and the upper limit for *static entries*. The lower part of the *Wizard* window displays the entries in detail, if any.



Removes the entries in the lower part of the *Wizard* window. The device removes the respective association between a port and the desired senders.

VLAN ID

Specifies the VLAN ID of the desired sender.

Possible values:

▶ 1..4042

MAC address

Specifies the MAC address of the desired sender.

Possible values:

▶ Valid Unicast MAC address
Specify the value with a colon separator, for example 00:11:22:33:44:55.

Note: You can assign a MAC address to only one port.

Add

Adds a *static entry* based on the values specified in the *VLAN ID* and *MAC address* fields. As a result, you find a new entry in the lower part of the *Wizard* window.

Entries in the lower part of the window

The lower part of the *Wizard* window displays the VLAN ID and MAC address of desired senders on this port. In the following list you find a description of the icons specific to these entries.



Static entry: When you click the icon, the device removes the *static entry* and the respective association between the port and the desired senders.



Dynamic entry: When you click the icon, the icon changes to . The device converts the *dynamic entry* to a *static entry* when you close the *Wizard* window. To undo this change, click the icon again before you close the *Wizard* window.

4.3 802.1X

[Network Security > 802.1X]

With the port-based access control according to IEEE 802.1X, the device monitors the access to the network from connected end devices. The device (authenticator) lets an end device (supplicant) have access to the network if it logs in with valid login data. The authenticator and the end devices communicate using the EAPoL (Extensible Authentication Protocol over LANs) authentication protocol.

The device supports the following methods to authenticate end devices:

- [radius](#)
A RADIUS server in the network authenticates the end devices.
- [ias](#)
The Integrated Authentication Server (IAS) implemented in the device authenticates the end devices. Compared to RADIUS, the IAS provides only basic functions.

The menu contains the following dialogs:

- ▶ [802.1X Global](#)
- ▶ [802.1X Port Configuration](#)
- ▶ [802.1X Port Clients](#)
- ▶ [802.1X EAPoL Port Statistics](#)
- ▶ [802.1X Port Authentication History](#)
- ▶ [802.1X Integrated Authentication Server \(IAS\)](#)

4.3.1 802.1X Global

[Network Security > 802.1X > Global]

This dialog lets you specify basic settings for the port-based access control.

Operation

Operation

Enables/disables the [802.1X](#) function.

Possible values:

- ▶ [On](#)
The [802.1X](#) function is enabled.
The device checks the access to the network from connected end devices.
The port-based access control is enabled.
- ▶ [Off](#) (default setting)
The [802.1X](#) function is disabled.
The port-based access control is disabled.

Configuration

VLAN assignment

Activates/deactivates the assigning of the relevant port to a VLAN. This function lets you provide selected services to the connected end device in this VLAN.

Possible values:

- ▶ [marked](#)
The assigning is active.
If the end device successfully authenticates itself, then the device assigns to the relevant port the VLAN ID transferred by the RADIUS authentication server.
- ▶ [unmarked](#) (default setting)
The assigning is inactive.
The relevant port is assigned to the VLAN specified in the [Network Security > 802.1X > Port Configuration](#) dialog, [Assigned VLAN ID](#) column.

Dynamic VLAN creation

Activates/deactivates the automatic creation of the VLAN assigned by the RADIUS authentication server if the VLAN does not exist.

Possible values:

- ▶ [marked](#)
The automatic VLAN creation is active.
The device sets up the VLAN if it does not exist.
- ▶ [unmarked](#) (default setting)
The automatic VLAN creation is inactive.
If the assigned VLAN does not exist, then the port remains assigned to the original VLAN.

Monitor mode

Activates/deactivates the monitor mode.

Possible values:

▶ **marked**

The monitor mode is active.

The device monitors the authentication and helps with diagnosing detected errors. If an end device has not logged in successfully, then the device gives the end device access to the network.

▶ **unmarked** (default setting)

The monitor mode is inactive.

Information

Monitor mode clients

Displays to how many end devices the device gave network access even though they did not log in successfully.

The prerequisite is that in the *Configuration* frame the *Monitor mode* function is active.

Non monitor mode clients

Displays the number of end devices to which the device gave network access after successful login.

Policy 1

Displays the method that the device currently uses to authenticate the end devices using the protocol 802.1X.

You specify the method used in the *Device Security > Authentication List* dialog.

- To authenticate the end devices through a RADIUS server, you assign the *radius* policy to the *8021x* list.
- To authenticate the end devices through the Integrated Authentication Server (IAS) you assign the *ias* policy to the *8021x* list.

4.3.2 802.1X Port Configuration

[Network Security > 802.1X > Port Configuration]

This dialog lets you specify the access settings for every port.

Table

For information on how to customize the appearance of the table, see [“Working with tables” on page 16](#).

Port

Displays the port number.

Port control

Specifies how the device grants access to the network ([Port control mode](#)).

Possible values:

- ▶ *forceUnauthorized*
The device blocks the access to the network. You use this setting if an end device is connected to the port that does not receive access to the network.
- ▶ *auto*
The device grants access to the network if the end device logged in successfully. You use this setting if an end device is connected to the port that logs in at the authenticator.

Note: If other end devices are connected through the same port, then they get access to the network without additional authentication.

- ▶ *forceAuthorized* (default setting)
When end devices do not support IEEE 802.1X, the device grants access to the network. You use this setting if an end device is connected to the port that receives access to the network without logging in.

Authentication state

Displays the current status of the authentication on the port ([Controlled Port Status](#)).

Possible values:

- ▶ *authorized*
The end device is logged in successfully.
- ▶ *unauthorized*
The end device is not logged in.

Assigned VLAN ID

Displays the VLAN that the authenticator assigned to the port. This value applies only on ports in which the *Port control* column contains the value *auto*.

Possible values:

- ▶ 0..4042 (default setting: 0)

You find the VLAN that the authenticator assigned to the ports in the *Network Security > 802.1X > Port Clients* dialog.

Reason

Displays the reason for the assignment of the VLAN. This value applies only on ports in which the *Port control* column contains the value *auto*.

Possible values:

- ▶ *notAssigned* (default setting)
- ▶ *radius*
- ▶ *guestVlan*
- ▶ *unauthenticatedVlan*

You find the VLAN that the authenticator assigned to the ports for a supplicant in the *Network Security > 802.1X > Port Clients* dialog.

Guest VLAN ID

Specifies the VLAN that the authenticator assigns to the port if the end device does not log in during the time period specified in the *Guest VLAN period* column. This value applies only on ports in which the *Port control* column contains the value *auto*.

This function lets you grant end devices, without IEEE 802.1X support, access to selected services in the network.

Possible values:

- ▶ 0 (default setting)
The authenticator does not assign a Guest VLAN to the port.
- ▶ 1..4042

Unauthenticated VLAN ID

Specifies the VLAN that the authenticator assigns to the port if the end device does not log in successfully. This value applies only on ports in which the *Port control* column contains the value *auto*.

This function lets you grant end devices without valid login data access to selected services in the network.

Possible values:

- ▶ 0..4042 (default setting: 0)

The effect of the value 0 is that the authenticator does not assign a Unauthenticated VLAN to the port.

Note: Assign to the port a VLAN set up statically in the device.

Periodic reauthentication

Activates/deactivates periodic reauthentication requests.

Possible values:

▶ **marked**

The periodic reauthentication requests are active.

The device periodically requests the end device to log in again. You specify this time period in the *Reauthentication period [s]* column.

If the authenticator assigned a Voice VLAN, Unauthenticated VLAN or Guest VLAN to the end device, then this setting becomes ineffective.

▶ **unmarked** (default setting)

The periodic reauthentication requests are inactive.

The device keeps the end device logged in.

Reauthentication period [s]

Specifies the period in seconds after which the authenticator periodically requests the end device to log in again.

Possible values:

▶ 1..65535 ($2^{16}-1$) (default setting: 3600)

Quiet period [s]

Specifies the time period in seconds in which the authenticator does not accept any more logins from the end device after an unsuccessful login attempt (*Quiet period [s]*).

Possible values:

▶ 0..65535 ($2^{16}-1$) (default setting: 60)

Transmit period [s]

Specifies the period in seconds after which the authenticator requests the end device to log in again. After this waiting period, the device sends an EAP request/identity data packet to the end device.

Possible values:

▶ 1..65535 ($2^{16}-1$) (default setting: 30)

Supplicant timeout [s]

Specifies the period in seconds for which the authenticator waits for the login of the end device.

Possible values:

▶ 1..65535 ($2^{16}-1$) (default setting: 30)

Server timeout [s]

Specifies the period in seconds for which the authenticator waits for the response from the authentication server (RADIUS or IAS).

Possible values:

▶ 1..65535 ($2^{16}-1$) (default setting: 30)

Requests (max.)

Specifies how many times the authenticator requests the end device to log in until the time specified in the *Supplicant timeout [s]* column has elapsed. The device sends an EAP request/identity data packet to the end device as often as specified here.

Possible values:

▶ 0..10 (default setting: 2)

Guest VLAN period

Displays the period in seconds for which the authenticator waits for EAPOL data packets after the end device is connected. If this period elapses, then the authenticator grants the end device access to the network and assigns the port to the Guest VLAN specified in the *Guest VLAN ID* column.

The value in this column is the triple of the value specified in the *Transmit period [s]* column.

Status

Displays the current status of the Authenticator ([Authenticator PAE state](#)).

Possible values:

- ▶ [initialize](#)
- ▶ [disconnected](#)
- ▶ [connecting](#)
- ▶ [authenticating](#)
- ▶ [authenticated](#)
- ▶ [aborting](#)
- ▶ [held](#)
- ▶ [forceAuth](#)
- ▶ [forceUnauth](#)

Backend authentication state

Displays the current status of the connection to the authentication server ([Backend Authentication state](#)).

Possible values:

- ▶ [request](#)
- ▶ [response](#)
- ▶ [success](#)
- ▶ [fail](#)
- ▶ [timeout](#)
- ▶ [idle](#)
- ▶ [initialize](#)

Initialize port

Activates/deactivates the port initialization to activate the access control on the port or reset it to its initial state. Use this function only on ports in which the [Port control](#) column contains the value [auto](#).

Possible values:

- ▶ [marked](#)
The port initialization is active.
When the initialization is complete, the device changes the value to [unmarked](#) again.
- ▶ [unmarked](#) (default setting)
The port initialization is inactive.
The device keeps the current port status.

Reauthenticate

Activates/deactivates the one-time reauthentication request.

Use this function only on ports in which the [Port control](#) column contains the value [auto](#).

The device also lets you periodically request the end device to log in again. See the [Periodic reauthentication](#) column.

Possible values:

- ▶ **marked**
The one-time reauthentication request is active.
The device requests the end device to log in again. Afterwards, the device changes the value to **unmarked** again.
- ▶ **unmarked** (default setting)
The one-time reauthentication request is inactive.
The device keeps the end device logged in.

4.3.3 802.1X Port Clients

[Network Security > 802.1X > Port Clients]

This dialog displays information on the connected end devices.

Table

For information on how to customize the appearance of the table, see [“Working with tables” on page 16](#).

Port

Displays the port number.

User name

Displays the user name with which the end device logged in.

MAC address

Displays the MAC address of the end device.

Filter ID

Displays the name of the filter list that the RADIUS authentication server assigned to the end device after successful authentication.

The authentication server transfers the filter ID attributes in the Access Accept data packet.

Assigned VLAN ID

Displays the VLAN that the authenticator assigned to the port after the successful authentication of the end device.

VLAN assignment reason

Displays the reason for the assignment of the VLAN.

Possible values:

- ▶ *default*
- ▶ *radius*
- ▶ *unauthenticatedVlan*
- ▶ *guestVlan*
- ▶ *monitorVlan*
- ▶ *invalid*

The field only displays a valid value as long as the client is authenticated.

Session timeout

Displays the remaining time in seconds until the login of the end device expires. This value applies only if for the port in the [Network Security > 802.1X > Port Configuration](#) dialog, *Port control* column the value *auto* is specified.

The authentication server assigns the timeout period to the device through RADIUS. The value 0 means that the authentication server has not assigned a timeout.

Termination action

Displays the action performed by the device when the login has elapsed.

Possible values:

- ▶ *default*
- ▶ *reauthenticate*

4.3.4 802.1X EAPOL Port Statistics

[Network Security > 802.1X > Statistics]

This dialog displays which EAPOL data packets the end device has sent and received for the authentication of the end devices.

Table

For information on how to customize the appearance of the table, see [“Working with tables” on page 16](#).

Buttons



Removes the selected table row.

Port

Displays the port number.

Received

Displays the total number of EAPOL data packets that the device received on the port.

Transmitted

Displays the total number of EAPOL data packets that the device sent on the port.

Start

Displays the number of EAPOL start data packets that the device received on the port.

Logoff

Displays the number of EAPOL logoff data packets that the device received on the port.

Response/ID

Displays the number of EAP response/identity data packets that the device received on the port.

Response

Displays the number of valid EAP response data packets that the device received on the port (without EAP response/identity data packets).

Request/ID

Displays the number of EAP request/identity data packets that the device received on the port.

Request

Displays the number of valid EAP request data packets that the device received on the port (without EAP request/identity data packets).

Invalid

Displays the number of EAPOL data packets with an unknown frame type that the device received on the port.

Received error

Displays the number of EAPOL data packets with an invalid packet body length field that the device received on the port.

Packet version

Displays the protocol version number of the EAPOL data packet that the device last received on the port.

Source of last received packet

Displays the sender MAC address of the EAPOL data packet that the device last received on the port.

The value `00:00:00:00:00:00` means that the port has not received any EAPOL data packets yet.

4.3.5 802.1X Port Authentication History

[Network Security > 802.1X > Port Authentication History]

The device registers the authentication process of the end devices that are connected to its ports. This dialog displays the information recorded during the authentication.

Table

For information on how to customize the appearance of the table, see [“Working with tables” on page 16](#).

Buttons



Removes the selected table row.

Port

Displays the port number.

Time

Displays the time at which the authenticator authenticated the end device.

Present for

Displays the time that has elapsed since the device generated this log entry.

MAC address

Displays the MAC address of the end device.

VLAN ID

Displays the ID of the VLAN that was assigned to the end device before the login.

Status

Displays the status of the authentication on the port.

Possible values:

- ▶ *success*
The authentication was successful.
- ▶ *failure*
The authentication did not succeed.

Access

Displays if the device grants the end device access to the network.

Possible values:

- ▶ *granted*
The device grants the end device access to the network.
- ▶ *denied*
The device denies the end device access to the network.

Assigned VLAN ID

Displays the ID of the VLAN that the authenticator assigned to the port.

VLAN type

Displays the type of the VLAN that the authenticator assigned to the port.

Possible values:

- ▶ *default*
- ▶ *radius*
- ▶ *unauthenticatedVlan*
- ▶ *guestVlan*
- ▶ *monitorVlan*
- ▶ *notAssigned*

Reason

Displays the reason for assigning the VLAN and the VLAN type.

4.3.6 802.1X Integrated Authentication Server (IAS)

[Network Security > 802.1X > IAS]

The Integrated Authentication Server (IAS) lets you authenticate end devices using the protocol 802.1X. Compared to RADIUS, the IAS has a very limited range of functions. The authentication is based only on the user name and the password.

In this dialog, you manage the login data of the end devices. The device lets you set up to 100 sets of login data.

To authenticate the end devices through the Integrated Authentication Server you assign in the [Device Security > Authentication List](#) dialog the `ias` policy to the 8021x list.

Table

For information on how to customize the appearance of the table, see [“Working with tables” on page 16](#).

Buttons



Add

Opens the [Create](#) window to add a table row.

- In the [User name](#) field, you specify the name of the user account on the end device.



Remove

Removes the selected table row.

User name

Displays the name of the user account on the end device.

To add a user account, click the  button.

Password

Specifies the password with which the user authenticates.

Possible values:

- ▶ Alphanumeric ASCII character string with 0..64 characters

The device differentiates between upper and lower case.

Active

Activates/deactivates the login data.

Possible values:

- ▶ **marked**
The login data is active. An end device has the option of logging in with this login data using the protocol 802.1X.
- ▶ **unmarked** (default setting)
The login data is inactive.

4.4 RADIUS

[Network Security > RADIUS]

With its factory settings, the device authenticates users based on the local user management. However, as the size of a network increases, it becomes more difficult to keep the login data of the users consistent across the devices.

RADIUS (Remote Authentication Dial-In User Service) lets you authenticate and authorize the users at a central point in the network. A RADIUS server performs the following tasks here:

- **Authentication**
The authentication server authenticates the users when the RADIUS client at the access point forwards the login data of the users to the server.
- **Authorization**
The authentication server authorizes logged in users for selected services by assigning various parameters for the relevant end device to the RADIUS client at the access point.
- **Accounting**
The accounting server records the traffic data that has occurred during the port authentication according to IEEE 802.1X. This lets you subsequently determine which services the users have used, and to what extent.

If you assign the **radius** policy to an application in the [Device Security > Authentication List](#) dialog, then the device operates in the role of the RADIUS client. The device forwards the login data of the users to the primary authentication server. The authentication server decides if the login data is valid and transfers the authorizations of the users to the device.

The device assigns the Service Type transferred in the response of a RADIUS server as follows to an access role existing in the device:

- **Administrative-User:** *administrator*
- **Login-User:** *operator*
- **NAS-Prompt-User:** *guest*

The device also lets you authenticate end devices with IEEE 802.1X through an authentication server. To do this, you assign the **radius** policy to the **8021x** list in the [Device Security > Authentication List](#) dialog.

The menu contains the following dialogs:

- ▶ [RADIUS Global](#)
- ▶ [RADIUS Authentication Server](#)
- ▶ [RADIUS Accounting Server](#)
- ▶ [RADIUS Authentication Statistics](#)
- ▶ [RADIUS Accounting Statistics](#)

4.4.1 RADIUS Global

[Network Security > RADIUS > Global]

This dialog lets you specify basic settings for RADIUS.

RADIUS configuration

Buttons



Reset

Deletes the statistics in the [Network Security > RADIUS > Authentication Statistics](#) dialog and in the [Network Security > RADIUS > Accounting Statistics](#) dialog.

Retransmits (max.)

Specifies how many times the device retransmits an unanswered request to the authentication server before the device sends the request to an alternative authentication server.

Possible values:

- ▶ [1..15](#) (default setting: 4)

Timeout [s]

Specifies how many seconds the device waits for a response after a request to an authentication server before it retransmits the request.

Possible values:

- ▶ [1..30](#) (default setting: 5)

Accounting

Activates/deactivates the accounting.

Possible values:

- ▶ [marked](#)
Accounting is active.
The device sends the traffic data to an accounting server specified in the [Network Security > RADIUS > Accounting Server](#) dialog.
- ▶ [unmarked](#) (default setting)
Accounting is inactive.

NAS IP address (attribute 4)

Specifies the IP address that the device transfers to the authentication server as attribute 4. Specify the IP address of the device or another available address.

Note: The device only includes the attribute 4 if the packet was triggered by the 802.1X authentication request of an end device (supplicant).

Possible values:

- ▶ Valid IPv4 address (default setting: 0.0.0.0)

In many cases, there is a firewall between the device and the authentication server. In the Network Address Translation (NAT) in the firewall changes the original IP address, and the authentication server receives the translated IP address of the device.

The device transfers the IP address in this field unchanged across the Network Address Translation (NAT).

4.4.2 RADIUS Authentication Server

[Network Security > RADIUS > Authentication Server]

This dialog lets you specify up to 8 authentication servers. An authentication server authenticates and authorizes the users when the device forwards the login data to the server.

The device sends the login data to the specified primary authentication server. When the server does not respond, the device contacts the specified authentication server that is highest in the table. When no response comes from this server either, the device contacts the next server in the table.

Table

For information on how to customize the appearance of the table, see [“Working with tables” on page 16](#).

Buttons



Add

Opens the [Create](#) window to add a table row.

- In the [Index](#) field, you specify the index number.
- In the [Address](#) field, you specify the IP address of the server.



Remove

Removes the selected table row.

Index

Displays the index number to which the table row relates. You specify the index number when you add a table row.

Name

Displays the name of the server. To change the value, click the relevant field.

Possible values:

- ▶ Alphanumeric ASCII character string with 1..32 characters
(default setting: [Default-RADIUS-Server](#))

You can specify the same name for several servers. When several servers have the same name, the setting in the [Primary server](#) column applies.

Address

Specifies the IP address of the server.

Possible values:

- ▶ Valid IPv4 address

Destination UDP port

Specifies the number of the UDP port on which the server receives requests.

Possible values:

- ▶ $0..65535$ ($2^{16}-1$) (default setting: 1812)
Exception: Port 2222 is reserved for internal functions.

Secret

Displays ***** (asterisks) when you specify a password with which the device logs into the server. To change the password, click the relevant field.

Possible values:

- ▶ Alphanumeric ASCII character string with 1..64 characters

You get the password from the administrator of the authentication server.

Primary server

Specifies the authentication server as primary or secondary.

Possible values:

- ▶ **marked**
The server is specified as the primary authentication server. The device sends the login data for authenticating the users to this authentication server.
This setting applies only if more than one server in the table has the same value in the *Name* column.
- ▶ **unmarked** (default setting)
The server is the secondary authentication server. When the device does not receive a response from the primary authentication server, the device sends the login data to the secondary authentication server.

Active

Activates/deactivates the connection to the server.

The device uses the server, if you specify in the *Device Security > Authentication List* dialog the value *radius* in one of the columns *Policy 1* to *Policy 5*.

Possible values:

- ▶ **marked** (default setting)
The connection is active. The device sends the login data for authenticating the users to this server if the preconditions named above are fulfilled.
- ▶ **unmarked**
The connection is inactive. The device does not send any login data to this server.

4.4.3 RADIUS Accounting Server

[Network Security > RADIUS > Accounting Server]

This dialog lets you specify up to 8 accounting servers. An accounting server records the traffic data that has occurred during the port authentication according to IEEE 802.1X. The prerequisite is that in the [Network Security > RADIUS > Global](#) dialog the [Accounting](#) function is active.

The device sends the traffic data to the first accounting server that can be reached. When the accounting server does not respond, the device contacts the next server in the table.

Table

For information on how to customize the appearance of the table, see [“Working with tables” on page 16](#).

Buttons



Add

Opens the [Create](#) window to add a table row.

- In the [Index](#) field, you specify the index number.
- In the [Address](#) field, you specify the IP address of the server.



Remove

Removes the selected table row.

Index

Displays the index number to which the table row relates. You specify the index number when you add a table row.

Possible values:

▶ 1..8

Name

Displays the name of the server.

To change the value, click the relevant field.

Possible values:

▶ Alphanumeric ASCII character string with 1..32 characters
(default setting: [Default-RADIUS-Server](#))

Address

Specifies the IP address of the server.

Possible values:

- ▶ Valid IPv4 address

Destination UDP port

Specifies the number of the UDP port on which the server receives requests.

Possible values:

- ▶ 0..65535 ($2^{16}-1$) (default setting: 1813)
Exception: Port 2222 is reserved for internal functions.

Secret

Displays ***** (asterisks) when you specify a password with which the device logs into the server. To change the password, click the relevant field.

Possible values:

- ▶ Alphanumeric ASCII character string with 1..16 characters

You get the password from the administrator of the authentication server.

Active

Activates/deactivates the connection to the server.

Possible values:

- ▶ **marked** (default setting)
The connection is active. The device sends traffic data to this server if the preconditions named above are fulfilled.
- ▶ **unmarked**
The connection is inactive. The device does not send any traffic data to this server.

4.4.4 RADIUS Authentication Statistics

[Network Security > RADIUS > Authentication Statistics]

This dialog displays information about the communication between the device and the authentication server. The table displays the information for each server in a separate table row.

To delete the statistic, click in the *Network Security > RADIUS > Global* dialog the  button.

Table

For information on how to customize the appearance of the table, see [“Working with tables” on page 16](#).

Name

Displays the name of the server.

IP address

Displays the IP address of the server.

Round trip time

Displays the time interval in hundredths of a second between the last response received from the server (Access Reply/Access Challenge) and the corresponding data packet sent (Access Request).

Access requests

Displays the number of access data packets that the device sent to the server. This value does not take repetitions into account.

Retransmitted access requests

Displays the number of access data packets that the device retransmitted to the server.

Access accepts

Displays the number of access accept data packets that the device received from the server.

Access rejects

Displays the number of access reject data packets that the device received from the server.

Access challenges

Displays the number of access challenge data packets that the device received from the server.

Malformed access responses

Displays the number of malformed access response data packets that the device received from the server (including data packets with an invalid length).

Bad authenticators

Displays the number of access response data packets with an invalid authenticator that the device received from the server.

Pending requests

Displays the number of access request data packets that the device sent to the server to which it has not yet received a response from the server.

Timeouts

Displays how many times no response to the server was received before the specified waiting time elapsed.

Unknown types

Displays the number data packets with an unknown data type that the device received from the server on the authentication port.

Packets dropped

Displays the number of data packets that the device received from the server on the authentication port and then discarded them.

4.4.5 RADIUS Accounting Statistics

[Network Security > RADIUS > Accounting Statistics]

This dialog displays information about the communication between the device and the accounting server. The table displays the information for each server in a separate table row.

To delete the statistic, click in the *Network Security > RADIUS > Global* dialog the  button.

Table

For information on how to customize the appearance of the table, see “Working with tables” on page 16.

Name

Displays the name of the server.

IP address

Displays the IP address of the server.

Round trip time

Displays the time interval in hundredths of a second between the last response received from the server (Accounting Response) and the corresponding data packet sent (Accounting Request).

Accounting requests

Displays the number of accounting request data packets that the device sent to the server. This value does not take repetitions into account.

Retransmitted accounting requests

Displays the number of accounting request data packets that the device retransmitted to the server.

Received packets

Displays the number of accounting response data packets that the device received from the server.

Malformed packets

Displays the number of malformed accounting response data packets that the device received from the server (including data packets with an invalid length).

Bad authenticators

Displays the number of accounting response data packets with an invalid authenticator that the device received from the server.

Pending requests

Displays the number of accounting request data packets that the device sent to the server to which it has not yet received a response from the server.

Timeouts

Displays how many times no response to the server was received before the specified waiting time elapsed.

Unknown types

Displays the number data packets with an unknown data type that the device received from the server on the accounting port.

Packets dropped

Displays the number of data packets that the device received from the server on the accounting port and then discarded them.

4.5 DoS

[Network Security > DoS]

Denial of Service (DoS) is a cyberattack that aims to make certain services or devices unusable. In this dialog, you can set up several filters to help protect the device itself and other devices in the network from DoS attacks.

The menu contains the following dialogs:

- ▶ [DoS Global](#)

4.5.1 DoS Global

[Network Security > DoS > Global]

In this dialog, you specify the DoS settings for the TCP/UDP, IP and ICMP protocols.

Note: We recommend activating the filters to increase the level of security of the device.

TCP/UDP

A scanner uses port scans to prepare network attacks. The scanner uses different techniques to determine running devices and open ports. This frame lets you activate filters for specific scanning techniques.

The device supports the detection of the following scan types:

- Null scans
- Xmas scans
- SYN/FIN scans
- TCP Offset attacks
- TCP SYN attacks
- L4 Port attacks
- Minimal Header scans

Null Scan filter

Activates/deactivates the Null Scan filter.

The device detects and discards incoming TCP packets with the following properties:

- No TCP flags are set.
- The TCP sequence number is 0.

Possible values:

- ▶ **marked**
The filter is active.
- ▶ **unmarked** (default setting)
The filter is inactive.

Xmas filter

Activates/deactivates the Xmas filter.

The device detects and discards incoming TCP packets with the following properties:

- The TCP flags *FIN*, *URG* and *PSH* are simultaneously set.
- The TCP sequence number is 0.

Possible values:

- ▶ **marked**
The filter is active.
- ▶ **unmarked** (default setting)
The filter is inactive.

SYN/FIN filter

Activates/deactivates the SYN/FIN filter.

The device detects incoming data packets with the TCP flags *SYN* and *FIN* set simultaneously and discards them.

Possible values:

- ▶ **marked**
The filter is active.
- ▶ **unmarked** (default setting)
The filter is inactive.

TCP Offset protection

Activates/deactivates the TCP Offset protection.

The TCP Offset protection detects incoming TCP data packets whose fragment offset field of the IP header is equal to 1 and discards them.

The TCP Offset protection accepts UDP and ICMP packets whose fragment offset field of the IP header is equal to 1.

Possible values:

- ▶ **marked**
The protection is active.
- ▶ **unmarked** (default setting)
The protection is inactive.

TCP SYN protection

Activates/deactivates the TCP SYN protection.

The TCP SYN protection detects incoming data packets with the TCP flag *SYN* set and a L4 source port <1024 and discards them.

Possible values:

- ▶ **marked**
The protection is active.
- ▶ **unmarked** (default setting)
The protection is inactive.

L4 Port protection

Activates/deactivates the L4 Port protection.

The L4 Port protection detects incoming TCP and UDP data packets whose source port number and destination port number are identical and discards them.

Possible values:

- ▶ **marked**
The protection is active.
- ▶ **unmarked** (default setting)
The protection is inactive.

Min. Header Size filter

Activates/deactivates the Minimal Header filter.

The Minimal Header filter detects incoming data packets whose IP payload length in the IP header minus the outer IP header size is smaller than the minimum TCP header size. If this is the first fragment that the device detects, then the device discards the data packet.

Possible values:

- ▶ **marked**
The filter is active.
- ▶ **unmarked** (default setting)
The filter is inactive.

Min. TCP header size

Displays the minimum size of a valid TCP header.

IP

Land Attack filter

Activates/deactivates the *Land Attack* filter. With the *Land Attack* method, the attacking station sends data packets whose source and destination addresses are identical to the IP address of the recipient.

Possible values:

- ▶ **marked**
The filter is active. The device discards data packets whose source and destination addresses are identical.
- ▶ **unmarked** (default setting)
The filter is inactive.

ICMP

This dialog provides you with filter options for the following ICMP parameters:

- Fragmented data packets
- ICMP packets from a specific size upwards
- Broadcast pings

Fragmented packets filter

Activates/deactivates the filter for fragmented ICMP packets.

The filter detects fragmented ICMP packets and discards them.

Possible values:

- ▶ **marked**
The filter is active.
- ▶ **unmarked** (default setting)
The filter is inactive.

Packet size filter

Activates/deactivates the filter for incoming ICMP packets.

The filter detects ICMP packets whose payload size exceeds the size specified in the *Allowed payload size [byte]* field and discards them.

Possible values:

- ▶ *marked*
The filter is active.
- ▶ *unmarked* (default setting)
The filter is inactive.

Allowed payload size [byte]

Specifies the maximum allowed payload size of ICMP packets in bytes.

Mark the *Packet size filter* checkbox if you want the device to discard incoming data packets whose payload size exceeds the maximum allowed size for ICMP packets.

Possible values:

- ▶ *0..1472* (default setting: *512*)

Drop broadcast ping

Activates/deactivates the filter for Broadcast Pings. Broadcast Pings are a known evidence for Smurf Attacks.

Possible values:

- ▶ *marked*
The filter is active.
The device detects Broadcast Pings and drops them.
- ▶ *unmarked* (default setting)
The filter is inactive.

4.6 ACL

[Network Security > ACL]

In this menu, you specify the settings for the Access Control Lists (ACL). Access Control Lists contain rules which the device applies successively to the data stream on its ports or VLANs.

If a data packet matches the criteria of one or more rules, then the device applies the action specified in the first applicable rule to the data stream. The device ignores the rules that follow the first applicable rule. Possible actions include:

- *permit*: The device forwards the data packet to a port or to a VLAN.
- *deny*: The device drops the data packet.

In the default setting, the device forwards every data packet. As soon as you assign an Access Control List to a port or VLAN, then this behavior changes. The device enters at the end of an Access Control List an implicit *Deny-All* rule. Consequently, the device discards data packets that do not match the criteria of any rules. If you want a different behavior, then add a *Permit-All* rule at the end of your Access Control Lists.

Proceed as follows to set up Access Control Lists and rules:

- Make a rule and specify the rule settings. See the [Network Security > ACL > IPv4 Rule](#) dialog, or the [Network Security > ACL > MAC Rule](#) dialog.
- Assign the Access Control List to the ports and VLANs of the device. See the [Network Security > ACL > Assignment](#) dialog.

The menu contains the following dialogs:

- ▶ [ACL IPv4 Rule](#)
- ▶ [ACL MAC Rule](#)
- ▶ [ACL Assignment](#)

4.6.1 ACL IPv4 Rule

[Network Security > ACL > IPv4 Rule]

In this dialog, you specify the rules that the device applies to the IP data packets.

An Access Control List (group) contains one or more rules. The device applies the rules of an Access Control List successively, beginning with the rule with the numerically lowest value in the *Index* column.

The device lets you filter according to the following criteria:

- Source or destination IP address of a data packet
- Type of the transmitting protocol
- Source or destination port of a data packet

Table

For information on how to customize the appearance of the table, see [“Working with tables” on page 16](#).

Buttons



Add

Opens the [Create](#) window to add a table row.

- From the [Group name](#) drop-down list, you select the Access Control List name to which the rule belongs or specify a new name. When you add a new name, click the **+** icon.
- In the *Index* field, you specify the number of the rule within the Access Control List. If the Access Control List contains multiple rules, then the device processes the rule with the lowest index value first.



Remove

Removes the selected table row.

Group name

Displays the name of the Access Control List. The Access Control List contains the rules.

Index

Displays the number of the rule within the Access Control List. You specify the index number when you add a table row.

If the Access Control List contains multiple rules, then the device processes the rule with the numerically lowest value first.

Match every packet

Specifies to which IP data packets the device applies the rule.

Possible values:

- ▶ **marked** (default setting)
The device applies the rule to every IP data packet.
- ▶ **unmarked**
The device applies the rule to IP data packets depending on the value in the following fields:
 - *Source IP address, Destination IP address, Protocol*
 - *DSCP, TOS priority, TOS mask*
 - *Packet fragmented*

Source IP address

Specifies the source address of the IP data packets to which the device applies the rule.

Possible values:

- ▶ **?.?.?.?** (default setting)
The device applies the rule to IP data packets with any source address.
- ▶ **Valid IPv4 address**
The device applies the rule to IP data packets with the specified source address. You use the ? character as a wild card.
Example **192.?.?.32**: The device applies the rule to IP data packets whose source address begins with **192.** and ends with **.32**.
- ▶ **Valid IPv4 address/bit mask**
The device applies the rule to IP data packets with the specified source address. The inverse bit mask lets you specify the address range with bit-level accuracy.
Example **192.168.1.0/0.0.0.127**: The device applies the rule to IP data packets with a source address in the range from **192.168.1.0** to **...127**.

Destination IP address

Specifies the destination address of the IP data packets to which the device applies the rule.

Possible values:

- ▶ **?.?.?.?** (default setting)
The device applies the rule to IP data packets with any destination address.
- ▶ **Valid IPv4 address**
The device applies the rule to data packets with the specified destination address. You use the ? character as a wild card.
Example **192.?.?.32**: The device applies the rule to IP data packets whose source address begins with **192.** and ends with **.32**.
- ▶ **Valid IPv4 address/bit mask**
The device applies the rule to data packets with the specified destination address. The inverse bit mask lets you specify the address range with bit-level accuracy.
Example **192.168.1.0/0.0.0.127**: The device applies the rule to IP data packets with a destination address in the range from **192.168.1.0** to **...127**.

Protocol

Specifies the IP protocol or Layer 4 protocol type of the data packets to which the device applies the rule. The device applies the rule only to data packets that contain the specified value in the *Protocol* field.

Possible values:

- ▶ **any** (default setting)
The device applies the rule to every IP data packet without evaluating the protocol type.
- ▶ **icmp**
Internet Control Message Protocol (RFC 792)
- ▶ **igmp**
Internet Group Management Protocol
- ▶ **ip-in-ip**
IP in IP tunneling (RFC 2003)
- ▶ **tcp**
Transmission Control Protocol (RFC 793)
- ▶ **udp**
User Datagram Protocol (RFC 768)
- ▶ **ip**
Internet Protocol

Source TCP/UDP port

Specifies the source port of the IP data packets to which the device applies the rule. The prerequisite is that in the *Protocol* column the value **TCP** or **UDP** is specified.

Possible values:

- ▶ **any** (default setting)
The device applies the rule to every IP data packet without evaluating the source port.
- ▶ **1..65535** ($2^{16}-1$)
The device applies the rule only to IP data packets containing the specified source port.

Destination TCP/UDP port

Specifies the destination port of the IP data packets to which the device applies the rule. The prerequisite is that in the *Protocol* column the value **TCP** or **UDP** is specified.

Possible values:

- ▶ **any** (default setting)
The device applies the rule to every IP data packet without evaluating the destination port.
- ▶ **1..65535** ($2^{16}-1$)
The device applies the rule only to IP data packets containing the specified destination port.

Action

Specifies how the device processes received IP data packets when the device applies the rule.

Possible values:

- ▶ **permit** (default setting)
The device forwards the IP data packets.
- ▶ **deny**
The device drops the IP data packets.

Log

Activates/deactivates the logging in the log file. See the [Diagnostics > Report > System Log](#) dialog.

Possible values:

▶ **marked**

Logging is active.

The prerequisite is that in the [Network Security > ACL > Assignment](#) dialog the Access Control List is assigned to a VLAN or port.

The device registers in the log file, in an interval of 30 s, how many times it applied the deny rule to IP data packets.

▶ **unmarked** (default setting)

Logging is inactive.

The device lets you activate this function for up to 128 deny rules.

4.6.2 ACL MAC Rule

[Network Security > ACL > MAC Rule]

In this dialog, you specify the rules that the device applies to the MAC data packets.

An Access Control List (group) contains one or more rules. The device applies the rules of an Access Control List successively, beginning with the rule with the numerically lowest value in the *Index* column.

The device lets you filter according to the following criteria:

- Source or destination MAC address of a data packet

Table

For information on how to customize the appearance of the table, see [“Working with tables” on page 16](#).

Buttons



Add

Opens the *Create* window to add a table row.

- From the *Group name* drop-down list, you select the Access Control List name to which the rule belongs or specify a new name. When you add a new name, click the **+** icon.
- In the *Index* field, you specify the number of the rule within the Access Control List. If the Access Control List contains multiple rules, then the device processes the rule with the lowest index value first.



Remove

Removes the selected table row.

Group name

Displays the name of the Access Control List. The Access Control List contains the rules.

Index

Displays the number of the rule within the Access Control List. You specify the index number when you add a table row.

If the Access Control List contains multiple rules, then the device processes the rule with the numerically lowest value first.

Match every packet

Specifies to which MAC data packets the device applies the rule.

Possible values:

- ▶ **marked** (default setting)
The device applies the rule to every MAC data packet.
- ▶ **unmarked**
The device applies the rule to MAC data packets depending on the value in the following fields:
 - *Source MAC address*
 - *Destination MAC address*

Source MAC address

Specifies the source address of the MAC data packets to which the device applies the rule.

Possible values:

- ▶ **?:?:?:?:?:?:?:?** (default setting)
The device applies the rule to MAC data packets with any source address.
- ▶ **Valid MAC address**
The device applies the rule to MAC data packets with the specified source address. You use the ? character as a wild card.
Example **00:11:?:?:?:?:?:?**: The device applies the rule to MAC data packets whose source address begins with **00:11**.
- ▶ **Valid MAC address/bit mask**
The device applies the rule to MAC data packets with the specified source address. The bit mask lets you specify the address range with bit-level accuracy.
Example **00:11:22:33:44:54/FF:FF:FF:FF:FF:FC**: The device applies the rule to MAC data packets with a source address in the range from **00:11:22:33:44:54** to **...:57**.

Destination MAC address

Specifies the destination address of the MAC data packets to which the device applies the rule.

Possible values:

- ▶ **?:?:?:?:?:?:?:?** (default setting)
The device applies the rule to MAC data packets with any destination address.
- ▶ **Valid MAC address**
The device applies the rule to MAC data packets with the specified destination address. You use the ? character as a wild card.
Example **00:11:?:?:?:?:?:?**: The device applies the rule to MAC data packets whose destination address begins with **00:11**.
- ▶ **Valid MAC address/bit mask**
The device applies the rule to MAC data packets with the specified source address. The bit mask lets you specify the address range with bit-level accuracy.
Example **00:11:22:33:44:54/FF:FF:FF:FF:FF:FC**: The device applies the rule to MAC data packets with a destination address in the range from **00:11:22:33:44:54** to **...:57**.

Action

Specifies how the device processes received MAC data packets when the device applies the rule.

Possible values:

- ▶ *permit* (default setting)
The device forwards the MAC data packets.
- ▶ *deny*
The device discards the MAC data packets.

Log

Activates/deactivates the logging in the log file. See the [Diagnostics > Report > System Log](#) dialog.

Possible values:

- ▶ *marked*
Logging is active.
The prerequisite is that in the [Network Security > ACL > Assignment](#) dialog the Access Control List is assigned to a VLAN or port.
The device registers in the log file, in an interval of 30 s, how many times it applied the deny rule to MAC data packets.
- ▶ *unmarked* (default setting)
Logging is inactive.

The device lets you activate this function for up to 128 deny rules.

4.6.3 ACL Assignment

[Network Security > ACL > Assignment]

This dialog lets you assign one or more Access Control Lists to the ports and VLANs of the device. By assigning a priority you specify the processing sequence, provided you assign one or more Access Control Lists to a port or VLAN.

The device applies rules successively, namely in the sequence specified by the rule index. You specify the priority of a group in the *Priority* column. The lower the number, the higher the priority. In this process, the device applies the rules with a high priority before the rules with a low priority.

The assignment of Access Control Lists to ports and VLANs results in the following different types of ACLs:

- Port-based IPv4 ACLs
- Port-based MAC ACLs
- VLAN-based IPv4 ACLs
- VLAN-based MAC ACLs

The device lets you apply the Access Control Lists to data packets received (*inbound*).

Note: Before you enable the function, verify that at least one active table row in the table lets you access. Otherwise, the connection to the device terminates if you change the settings. To access the device management is possible only using the CLI through the serial interface of the device.

Table

For information on how to customize the appearance of the table, see “Working with tables” on page 16.

Buttons



Add

Opens the *Create* window to assign a rule to a port or a VLAN.

- From the *Port/VLAN* drop-down list, you select the port or the VLAN to which the device applies the rule.
- In the *Priority* field, you specify the sequence in which the device applies the rules to the data stream.
- From the *Direction* drop-down list, you select if the device applies the rule to received or sent data packets.
- From the *Group name* drop-down list, you select the rule that the device assigns to the port or VLAN.



Remove

Removes the selected table row.

Group name

Displays the name of the Access Control List. The Access Control List contains the rules.

Type

Displays if the Access Control List contains MAC rules or IPv4 rules.

Possible values:

- ▶ *mac*
The Access Control List contains MAC rules.
- ▶ *ip*
The Access Control List contains IPv4 rules.

You edit Access Control Lists with IPv4 rules in the [Network Security > ACL > IPv4 Rule](#) dialog. You edit Access Control Lists with MAC rules in the [Network Security > ACL > MAC Rule](#) dialog.

Port

Displays the port to which the Access Control List is assigned. The field remains empty when the Access Control List is assigned to a VLAN.

VLAN ID

Displays the VLAN to which the Access Control List is assigned. The field remains empty when the Access Control List is assigned to a port.

Direction

Displays that the device applies the Access Control List to received data packets. The device can apply the Access Control Lists only to received data packets.

Priority

Displays the priority of the Access Control List.

Using the priority, you specify the sequence in which the device applies the Access Control Lists to the data stream. The device applies the rules in ascending order which starts with priority 1. If an Access Control List is assigned to a port and to a VLAN with the same priority, then the device applies the rules to the port first.

Possible values:

- ▶ 1..4294967295 ($2^{32}-1$)

Active

Displays if the Access Control List on the port or in the VLAN is active.

Possible values:

- ▶ *marked* (default setting)
The Access Control List is active.
- ▶ *unmarked*
The Access Control List is inactive.

5 Switching

The menu contains the following dialogs:

- ▶ Switching Global
- ▶ Rate Limiter
- ▶ Filter for MAC Addresses
- ▶ IGMP Snooping
- ▶ MRP-IEEE
- ▶ GARP
- ▶ QoS/Priority
- ▶ VLAN
- ▶ L2-Redundancy

5.1 Switching Global

[Switching > Global]

This dialog lets you specify the following settings:

- Change the Aging time of the MAC address table (forwarding database) entries
- Enable the flow control in the device
- Activate the *VLAN-unaware mode* function

If a large number of data packets are received in the priority queue of a port at the same time, then this can cause the port memory to overflow. This happens, for example, when the device receives data on a Gigabit port and forwards it to a port with a lower bandwidth. The device discards superfluous data packets.

The flow control mechanism defined in IEEE 802.3 helps ensure that no data packets are lost due to a buffer overflow on a port. Shortly before the buffer memory of a port is completely full, the device signals to the connected devices that it is not accepting any more data packets from them.

- In full-duplex mode, the device sends a pause data packet.
- In half-duplex mode, the device simulates a collision.

The connected devices then stop sending data packets for the duration of the signaling. On an uplink port, this can possibly cause undesired sending interruptions in the higher-level network segment (“wandering backpressure”). The flow control mechanism thus lowers the network to the bandwidth that the slowest device in the network can process.

According to IEEE 802.1Q, the device forwards data packets with a VLAN tag in a VLAN ≥ 1 . However, a few applications on connected end devices send or receive data packets with a VLAN ID=0. Data packets with a VLAN ID=0 are called *Priority Tagged Frames*. When the device receives one of these data packets, before forwarding it, the device overwrites the original value in the data packet with the VLAN ID of the receiving port.

If you activate the *VLAN-unaware mode* function, then this deactivates the VLAN settings in the device. The device then transparently forwards the data packets and evaluates the priority information contained only in the data packet.

Configuration

MAC address

Displays the MAC address of the device.

Aging time [s]

Specifies the aging time in seconds.

Possible values:

- ▶ 10..500000 (default setting: 30)

The device monitors the age of the learned unicast MAC addresses. The device deletes address entries that exceed a particular age (aging time) from its MAC address table (forwarding database).

You find the MAC address table (forwarding database) in the [Switching > Filter for MAC Addresses](#) dialog.

Flow control

Activates/deactivates the flow control in the device.

Possible values:

- ▶ **marked**
The flow control is active in the device.
Additionally activate the flow control on the required ports. See the [Basic Settings > Port](#) dialog, [Configuration](#) tab, checkbox in the [Flow control](#) column.
- ▶ **unmarked** (default setting)
The flow control is inactive in the device.

If you are using a redundancy function, then you deactivate the flow control on the participating ports. If the flow control and the redundancy function are active at the same time, it is possible that the redundancy function operates differently than intended.

VLAN-unaware mode

Activates/deactivates the mode in which the device ignores the VLAN ID and forwards the data packets unchanged. The device continues to evaluate the priority information in the data packets.

On the connected end devices, only some applications require receiving data packets with a VLAN ID=0. If applications in the network require this, then activate the function.

Possible values:

- ▶ **marked**
The device operates in the *VLAN-unaware* mode according to IEEE 802.1Q:
 - The device ignores the VLAN settings in the device and the VLAN ID in the data packets. The device forwards the data packets based on their destination MAC address.
 - The device evaluates the priority information contained in the VLAN tag of the data packets.
 - The device ignores the VLAN settings specified in the [Switching > VLAN > Configuration](#) and [Switching > VLAN > Port](#) dialogs.

Note: You specify the VLAN ID **1** for every function in the device which uses VLAN settings. Among other things, this applies to static filters, MRP and IGMP Snooping.

► **unmarked** (default setting)

The device operates in the *VLAN-aware* mode according to IEEE 802.1Q:

- The device evaluates the VLAN tags in the data packets.
- The device forwards the data packets based on their destination MAC address or destination IP address in the corresponding VLAN.
- The device evaluates the priority information contained in the data packet.
- When the device receives a data packet with a VLAN ID=**0** it assigns the VLAN ID of the port to the data packet. See the [Switching > VLAN > Port](#) dialog.

5.2 Rate Limiter

[Switching > Rate Limiter]

The device lets you limit the amount of data packets on the ports to help provide stable operation even with a large data volume. If the amount of data packets on a port exceed the threshold value, then the device discards the excess data packets on this port.

The rate limiter function operates only on Layer 2, and is used to limit the effects of storms of data packets that flood the device (typically Broadcasts).

The rate limiter function ignores protocol information on higher layers, such as IP or TCP.

The dialog contains the following tabs:

- ▶ [\[Ingress\]](#)
- ▶ [\[Egress\]](#)

[Ingress]

In this tab you enable the *Rate Limiter* function. The threshold value specifies the maximum amount of data packets the port receives. If the amount of data packets on a port exceed the specified threshold value, then the device discards the excess data packets on this port.

Table

For information on how to customize the appearance of the table, see [“Working with tables” on page 16](#).

Port

Displays the port number.

Unit

Specifies the unit for the threshold value:

Possible values:

- ▶ *percent* (default setting)
Specifies the threshold value as a percentage of the data rate of the port.
- ▶ *pps*
Specifies the threshold value in data packets per second.

Broadcast mode

Activates/deactivates the rate limiter function for received broadcast data packets.

Possible values:

- ▶ *marked*
- ▶ *unmarked* (default setting)

If the threshold value is exceeded, then the device discards the excess broadcast data packets on this port.

Broadcast threshold

Specifies the threshold value for received broadcasts on this port.

Possible values:

- ▶ `0..14880000` (default setting: `0`)

The value `0` deactivates the rate limiter function on this port.

- If you select the value *percent* in the *Unit* column, then enter a percentage value from `1` to `100`.
- If you select the value *pps* in the *Unit* column, then enter an absolute value for the data rate.

Multicast mode

Activates/deactivates the rate limiter function for received multicast data packets.

Possible values:

- ▶ `marked`
- ▶ `unmarked` (default setting)

If the threshold value is exceeded, then the device discards the excess multicast data packets on this port.

Multicast threshold

Specifies the threshold value for received multicasts on this port.

Possible values:

- ▶ `0..14880000` (default setting: `0`)

The value `0` deactivates the rate limiter function on this port.

- If you select the value *percent* in the *Unit* column, then enter a percentage value from `0` to `100`.
- If you select the value *pps* in the *Unit* column, then enter an absolute value for the data rate.

Unknown unicast mode

Activates/deactivates the rate limiter function for received unicast data packets with an unknown destination address.

Possible values:

- ▶ `marked`
- ▶ `unmarked` (default setting)

If the threshold value is exceeded, then the device discards the excess unicast data packets on this port.

Unicast threshold

Specifies the threshold value for received unicasts with an unknown destination address on this port.

Possible values:

- ▶ `0..14880000` (default setting: `0`)

The value `0` deactivates the rate limiter function on this port.

- If you select the value *percent* in the *Unit* column, then enter a percentage value from `0` to `100`.
- If you select the value *pps* in the *Unit* column, then enter an absolute value for the data rate.

[Egress]

In this tab you specify the egress transmission rate on the port.

Table

For information on how to customize the appearance of the table, see [“Working with tables” on page 16](#).

Port

Displays the port number.

Bandwidth [%]

Specifies the egress transmission rate.

Possible values:

- ▶ 0 (default setting)
The bandwidth limitation is disabled.
- ▶ 1..100
The bandwidth limitation is enabled.
This value specifies the percentage of overall link speed for the port in 1% increments.

5.3 Filter for MAC Addresses

[Switching > Filter for MAC Addresses]

This dialog lets you display and edit address filters for the MAC address table (forwarding database). Address filters specify the way the data packets are forwarded in the device based on the destination MAC address.

Each table row represents one filter. The device automatically sets up the filters. The device lets you set up additional filters manually.

The device forwards the data packets as follows:

- When the table contains the destination address of a data packet, the device forwards the data packet from the receiving port to the port specified in the table row.
- When there is no table row for the destination address, the device forwards the data packet from the receiving port to every other port.

Table

To delete the learned MAC addresses from the MAC address table (forwarding database), click in the [Basic Settings > Restart](#) dialog the [Clear FDB](#) button.

For information on how to customize the appearance of the table, see [“Working with tables” on page 16](#).

Buttons



Add

Opens the [Create](#) window to add a table row.

- In the [MAC address](#) field, you specify the destination MAC address.
- In the [VLAN ID](#) field, you specify the VLAN ID.
- In the list field, you select the ports.
 - If the destination MAC address is a unicast address, select exactly one port.
 - If the destination MAC address is a multicast or broadcast address, select one or more ports.
 - Do not select a port to add a [Discard](#) filter. The device discards data packets with the destination MAC address specified in the table row.



Remove

Removes the selected table row.



Clear FDB

Removes the MAC addresses from the forwarding table that have the value [Learned](#) in the [Status](#) column.

Address

Displays the destination MAC address to which the table row relates.

VLAN ID

Displays the ID of the VLAN to which the table row relates.

The device learns the MAC addresses for every VLAN separately (independent VLAN learning).

Status

Displays how the device has set up the address filter.

Possible values:

- ▶ *Learned*
Address filter set up automatically by the device based on received data packets.
- ▶ *Mgmt*
MAC address of the device. The address filter is protected against changes.
- ▶ *Other*
Static address added by the following function:
 - *802.1X*
 - *Port Security*
- ▶ *Permanent*
Address filter set up manually. The address filter stays set up permanently.
- ▶ *IGMP*
Address filter automatically set up by IGMP Snooping.
- ▶ *MRP-MMRP*
Multicast address filter automatically set up by MMRP.

<Port number>

Displays how the corresponding port transmits data packets which it directs to the adjacent destination address.

Possible values:

- ▶ *-*
The port does not transmit any data packets to the destination address.
- ▶ *learned*
The port transmits data packets to the destination address. The device has automatically set up the filter based on received data packets.
- ▶ *IGMP learned*
The port transmits data packets to the destination address. The device has automatically set up the filter based on IGMP.
- ▶ *unicast static*
The port transmits data packets to the destination address. A user has set up the filter.
- ▶ *multicast static*
The port transmits data packets to the destination address. A user has set up the filter.

5.4 IGMP Snooping

[Switching > IGMP Snooping]

The Internet Group Management Protocol (IGMP) is a protocol for dynamically managing Multicast groups. The protocol describes the distribution of Multicast data packets between routers and end devices on Layer 3.

The device lets you use the IGMP Snooping function to also use the IGMP mechanisms on Layer 2:

- Without IGMP Snooping, the device forwards the Multicast data packets to every port.
- With the activated IGMP Snooping function, the device forwards the Multicast data packets only on ports to which Multicast receivers are connected. This reduces the network load. The device evaluates the IGMP data packets transmitted on Layer 3 and uses the information on Layer 2.

Activate the IGMP Snooping function not until the following conditions are fulfilled:

- There is a Multicast router in the network that generates IGMP queries (periodic queries).
- The devices participating in IGMP Snooping forward the IGMP queries.

The device links the IGMP reports with the entries in its MAC address table (forwarding database). When a multicast receiver joins a multicast group, the device adds a table row for this port in the [Switching > Filter for MAC Addresses](#) dialog. When the multicast receiver leaves the multicast group, the device removes the table row.

The menu contains the following dialogs:

- ▶ [IGMP Snooping Global](#)
- ▶ [IGMP Snooping Configuration](#)
- ▶ [IGMP Snooping Enhancements](#)
- ▶ [IGMP Snooping Querier](#)
- ▶ [IGMP Snooping Multicasts](#)

5.4.1 IGMP Snooping Global

[Switching > IGMP Snooping > Global]

This dialog lets you enable the *IGMP Snooping* function in the device and set the function up for each port and each VLAN.

Operation

Operation

Enables/disables the *IGMP Snooping* function in the device.

Possible values:

▶ *On*

The *IGMP Snooping* function is enabled in the device according to RFC 4541 (*Considerations for Internet Group Management Protocol (IGMP) and Multicast Listener Discovery (MLD) Snooping Switches*).

▶ *Off* (default setting)

The *IGMP Snooping* function is disabled in the device.

The device transmits received query, report, and leave data packets without evaluating them. Received data packets with a Multicast destination address are transmitted to every port by the device.

Information

Buttons



Reset IGMP snooping counters

Removes the IGMP Snooping entries and resets the counter in the *Information* frame to 0.

Processed multicast controls

Displays the number of Multicast control data packets processed.

This statistic encompasses the following packet types:

- IGMP Reports
- IGMP Queries version V1
- IGMP Queries version V2
- IGMP Queries version V3
- IGMP Queries with an incorrect version
- PIM or DVMRP packets

The device uses the Multicast control data packets to set up the MAC address table (forwarding database) for transmitting the Multicast data packets.

Possible values:

▶ 0..2147483647 ($2^{31}-1$)

You use the *Clear IGMP snooping data* button in the *Basic Settings > Restart* dialog or the command `clear igmp-snooping` using the Command Line Interface to reset the IGMP Snooping entries, including the counter for the processed multicast control data packets.

5.4.2 IGMP Snooping Configuration

[Switching > IGMP Snooping > Configuration]

This dialog lets you enable the *IGMP Snooping* function in the device and set the function up for each port and each VLAN.

The dialog contains the following tabs:

- ▶ [VLAN ID]
- ▶ [Port]

[VLAN ID]

In this tab you set up the *IGMP Snooping* function for every VLAN.

Table

For information on how to customize the appearance of the table, see [“Working with tables” on page 16](#).

VLAN ID

Displays the ID of the VLAN to which the table row relates.

Active

Activates/deactivates the *IGMP Snooping* function for this VLAN.

The prerequisite is that the *IGMP Snooping* function is globally enabled.

Possible values:

- ▶ **marked**
IGMP Snooping is activated for this VLAN. The VLAN has joined the Multicast data stream.
- ▶ **unmarked** (default setting)
IGMP Snooping is deactivated for this VLAN. The VLAN has left the Multicast data stream.

Group membership interval

Specifies the time in seconds for which a VLAN from a dynamic Multicast group remains entered in the MAC address table (forwarding database) when the device does not receive any more report data packets from the VLAN.

Specify a value larger than the value in the *Max. response time* column.

Possible values:

- ▶ 2..3600 (default setting: 260)

Max. response time

Specifies the time in seconds in which the members of a Multicast group respond to a query data packet. For their response, the members specify a random time within the response time. You thus help prevent the multicast group members from responding to the query at the same time.

Specify a value smaller than the value in the *Group membership interval* column.

Possible values:

- ▶ 1..25 (default setting: 10)

Fast leave admin mode

Activates/deactivates the Fast Leave function for this VLAN.

Possible values:

- ▶ **marked**
When the Fast Leave function is active and the device receives an IGMP Leave message from a multicast group, the device immediately removes the entry from its MAC address table (forwarding database).
- ▶ **unmarked** (default setting)
When the Fast Leave function is inactive, the device first sends MAC-based queries to the members of the multicast group and removes an entry when a VLAN does not send any more report messages.

MRP expiration time

Multicast Router Present Expiration Time. Specifies the time in seconds for which the device waits for a query on this port that belongs to a VLAN. When the port does not receive a query data packet, the device removes the port from the list of ports with connected multicast routers.

You have the option of configuring this parameter only if the port belongs to an existing VLAN.

Possible values:

- ▶ 0
unlimited timeout - no expiration time
- ▶ 1..3600 (default setting: 260)

[Port]

In this tab you set up the *IGMP Snooping* function for every port.

Table

For information on how to customize the appearance of the table, see [“Working with tables” on page 16](#).

Port

Displays the port number.

Active

Activates/deactivates the *IGMP Snooping* function on the port.

The prerequisite is that the *IGMP Snooping* function is globally enabled.

Possible values:

- ▶ **marked** (default setting)
IGMP Snooping is active on this port. The device includes the port in the multicast data stream.
- ▶ **unmarked**
IGMP Snooping is inactive on this port. The port left the multicast data stream.

Group membership interval

Specifies the time in seconds for which a port, from a dynamic multicast group, remains entered in the MAC address table (forwarding database) when the device does not receive any more report data packets from the port.

Possible values:

- ▶ **2..3600** (default setting: 260)

Specify the value larger than the value in the *Max. response time* column.

Max. response time

Specifies the time in seconds in which the members of a Multicast group respond to a query data packet. For their response, the members specify a random time within the response time. You thus help prevent the multicast group members from responding to the query at the same time.

Possible values:

- ▶ **1..25** (default setting: 10)

Specify a value lower than the value in the *Group membership interval* column.

MRP expiration time

Specifies the Multicast Router Present Expiration Time. The MRP expiration time is the time in seconds for which the device waits for a query packet on this port. When the port does not receive a query data packet, the device removes the port from the list of ports with connected multicast routers.

Possible values:

- ▶ **0**
unlimited timeout - no expiration time
- ▶ **1..3600** (default setting: 260)

Fast leave admin mode

Activates/deactivates the Fast Leave function on the port.

Possible values:

- ▶ **marked**
When the Fast Leave function is active and the device receives an IGMP Leave message from a multicast group, the device immediately removes the entry from its MAC address table (forwarding database).
- ▶ **unmarked** (default setting)
When the Fast Leave function is inactive, the device first sends MAC-based queries to the members of the multicast group and removes an entry when a port does not send any more report messages.

Static query port

Activates/deactivates the *Static query port* mode.

Possible values:

- ▶ **marked**
The *Static query port* mode is active.
The port is a static query port in the set-up VLANs.
- ▶ **unmarked** (default setting)
The *Static query port* mode is inactive.
The port is not a static query port. The device transmits IGMP report messages to the port only if it receives IGMP queries.

VLAN IDs

Displays the ID of the VLANs to which the table row relates.

5.4.3 IGMP Snooping Enhancements

[Switching > IGMP Snooping > Snooping Enhancements]

This dialog lets you select a port for a VLAN and to set up the port.

Table

For information on how to customize the appearance of the table, see [“Working with tables” on page 16](#).

Buttons



Wizard

Opens the [Wizard](#) window that helps you select and set up the ports. See [“\[Wizard: IGMP snooping enhancements\]” on page 205](#).

VLAN ID

Displays the ID of the VLAN to which the table row relates.

<Port number>

Displays for every VLAN set up in the device if the relevant port is a query port. Additionally, the field displays if the device transmits every Multicast stream in the VLAN to this port.

Possible values:

- ▶ -
The port is not a query port in this VLAN.
- ▶ L = Learned
The device detected the port as a query port because the port received IGMP queries in this VLAN. The port is not a statically set up query port.
- ▶ A = Automatic
The device detected the port as a query port. The prerequisite is that you set up the port as [Learn by LLDP](#).
- ▶ S = Static (manual setting)
A user specified the port as a static query port. The device transmits IGMP reports only to ports on which it previously received IGMP queries – and to statically set-up query ports.
To assign this value, perform the following steps:
 - Open the [Wizard](#) window.
 - On the [Configuration](#) page, mark the [Static](#) checkbox.

- ▶ **P = Learn by LLDP (manual setting)**
A user specified the port as *Learn by LLDP*.
With the Link Layer Discovery Protocol (LLDP), the device detects Hirschmann devices connected directly to the port. The device denotes the detected query ports with **A**.
To assign this value, perform the following steps:
 - Open the *Wizard* window.
 - On the *Configuration* page, mark the *Learn by LLDP* checkbox.
- ▶ **F = Forward All (manual setting)**
A user specified the port so that the device forwards every received Multicast stream in the VLAN to this port. Use this setting for diagnostic purposes, for example.
To assign this value, perform the following steps:
 - Open the *Wizard* window.
 - On the *Configuration* page, mark the *Forward all* checkbox.

Display categories

Enhances the clarity of the display. The table emphasizes the cells which contain the specified value. This helps to analyze and sort the table according to your needs.

Possible values:

- ▶ **Learned (L)**
The table displays cells which contain the value **L** and possibly further values. Cells which contain other values than **L** only, the table displays with the “-” symbol.
- ▶ **Static (S)**
The table displays cells which contain the value **S** and possibly further values. Cells which contain other values than **S** only, the table displays with the “-” symbol.
- ▶ **Automatic (A)**
The table displays cells which contain the value **A** and possibly further values. Cells which contain other values than **A** only, the table displays with the “-” symbol.
- ▶ **Learned by LLDP (P)**
The table displays cells which contain the value **P** and possibly further values. Cells which contain other values than **P** only, the table displays with the “-” symbol.
- ▶ **Forward all (F)**
The table displays cells which contain the value **F** and possibly further values. Cells which contain other values than **F** only, the table displays with the “-” symbol.

[Wizard: IGMP snooping enhancements]

The *Wizard* window helps you select and set up the ports.

The *Wizard* window guides you through the following steps:

- [Selection VLAN/Port](#)
- [Configuration](#)

After closing the *Wizard* window, click the  button to save your settings.

Selection VLAN/Port

VLAN ID

Select the VLAN ID.

Port

Select the ports.

Configuration

VLAN ID

Displays the selected VLAN ID.

Port

Displays the number of the selected ports.

Static

Specifies the port as a static query port in the set-up VLANs. The device transmits IGMP report messages to the ports at which it receives IGMP queries. This lets you also transmit IGMP report messages to other selected ports or connected Hirschmann devices ([Automatic](#)).

Learn by LLDP

Specifies the port as [Learn by LLDP](#). Lets the device detect directly connected Hirschmann devices using LLDP and learn the related ports as a query port.

Forward all

Specifies the port as [Forward all](#). With the [Forward all](#) setting, the device sends on this port every data packet with a Multicast address in the destination address field.

5.4.4 IGMP Snooping Querier

[Switching > IGMP Snooping > Querier]

The device forwards a Multicast stream only to those ports to which a Multicast receiver is connected.

To detect which ports Multicast receivers are connected to, the device sends query data packets on the ports at a given interval. When a Multicast receiver is connected, it joins the Multicast stream by responding to the device with a report data packet.

This dialog lets you set up the Snooping Querier settings globally and for the set-up VLANs.

Operation

Operation

Enables/disables the IGMP Querier function globally in the device.

Possible values:

- ▶ *On*
- ▶ *Off* (default setting)

Configuration

In this frame you specify the IGMP Snooping Querier settings for the *General Query* data packets.

Protocol version

Specifies the IGMP version of the *General Query* data packets.

Possible values:

- ▶ *1*
IGMP v1
- ▶ *2* (default setting)
IGMP v2
- ▶ *3*
IGMP v3

Query interval [s]

Specifies the time in seconds after which the device itself generates *General Query* data packets when it has received query data packets from the Multicast router.

Possible values:

- ▶ 1..1800 (default setting: 60)

Expiry interval [s]

Specifies the time in seconds after which an active querier switches from the passive state back to the active state if it has not received any query packets for longer than specified here.

Possible values:

- ▶ 60..300 (default setting: 125)

Table

In the table you specify the Snooping Querier settings for the set-up VLANs.

For information on how to customize the appearance of the table, see [“Working with tables” on page 16](#).

VLAN ID

Displays the ID of the VLAN to which the table row relates.

Active

Activates/deactivates the IGMP Snooping Querier function for this VLAN.

Possible values:

- ▶ **marked**
The IGMP Snooping Querier function is active for this VLAN.
- ▶ **unmarked** (default setting)
The IGMP Snooping Querier function is inactive for this VLAN.

Current state

Displays if the Snooping Querier is active for this VLAN.

Possible values:

- ▶ **marked**
The Snooping Querier is active for this VLAN.
- ▶ **unmarked**
The Snooping Querier is inactive for this VLAN.

IP address

Specifies the IP address that the device adds as the source address in generated *General Query* data packets. You use the address of the multicast router.

Possible values:

- ▶ Valid IPv4 address (default setting: `0.0.0.0`)

Protocol version

Displays the Internet Group Management Protocol (IGMP) version of the *General Query* data packets.

Possible values:

- ▶ 1
IGMP v1
- ▶ 2 (default setting)
IGMP v2
- ▶ 3
IGMP v3

Max. response time

Displays the time in seconds in which the members of a Multicast group respond to a query data packet. For their response, the members specify a random time within the response time. This helps prevent every Multicast group member to respond to the query at the same time.

Last querier address

Displays the IP address of the Multicast router from which the last received IGMP query was sent out..

Last querier version

Displays the IGMP version that the Multicast router used when sending out the last IGMP query received in this VLAN.

5.4.5 IGMP Snooping Multicasts

[Switching > IGMP Snooping > Multicasts]

The device lets you specify how it forwards data packets with unknown Multicast addresses: Either the device discards these data packets, floods them to every port, or forwards them only to the ports that previously received query packets.

The device also forwards the data packets with known Multicast addresses to the query ports.

Configuration

Unknown multicasts

Specifies how the device forwards data packets with unknown Multicast addresses.

Possible values:

- ▶ *Discard*
The device discards data packets with an unknown MAC Multicast address.
- ▶ *Send to all ports* (default setting)
The device forwards data packets with an unknown MAC Multicast address to every port.
- ▶ *Send to query ports*
The device forwards data packets with an unknown MAC Multicast address to the query ports.

Table

In the table you specify the settings for known Multicasts for the set-up VLANs.

For information on how to customize the appearance of the table, see [“Working with tables” on page 16](#).

VLAN ID

Displays the ID of the VLAN to which the table row relates.

Known multicasts

Specifies how the device forwards data packets with known Multicast addresses.

Possible values:

- ▶ *send to query and registered ports*
The device forwards data packets with a known MAC/IP Multicast address to the query ports and to the registered ports.
- ▶ *send to registered ports* (default setting)
The device forwards data packets with a known MAC/IP Multicast address to registered ports.

5.5 MRP-IEEE

[Switching > MRP-IEEE]

The IEEE 802.1ak amendment to the IEEE 802.1Q standard introduced the Multiple Registration Protocol (MRP) to replace the Generic Attribute Registration Protocol (GARP). The IEEE standards association also modified and replaced the GARP applications, GARP Multicast Registration Protocol (GMRP) and GARP VLAN Registration Protocol (GVRP). The Multiple MAC Registration Protocol (MMRP) and the Multiple VLAN Registration Protocol (MVRP) replace these protocols.

MRP-IEEE helps confine traffic to the required areas of the LAN. To confine traffic, the MRP-IEEE applications distribute attribute values to participating MRP-IEEE devices across a LAN registering and de-registering multicast group membership and VLAN identifiers.

Registering group participants lets you reserve resources for specific data packets transversing a LAN. Defining resource requirements regulates the level of traffic, allowing the devices to determine the required resources and provides for dynamic maintenance of the allocated resources.

The menu contains the following dialogs:

- ▶ [MRP-IEEE Configuration](#)
- ▶ [MRP-IEEE Multiple MAC Registration Protocol](#)
- ▶ [MRP-IEEE Multiple VLAN Registration Protocol](#)

5.5.1 MRP-IEEE Configuration

[Switching > MRP-IEEE > Configuration]

This dialog lets you set the various MRP timers. By maintaining a relationship between the various timer values, the protocol operates efficiently and with less likelihood of unnecessary attribute withdraws and re-registrations. The default timer values effectively maintain these relationships.

When you reconfigure the timers, maintain the following relationships:

- To allow for re-registration after a Leave or LeaveAll event, even if there is a lost message, specify the LeaveTime to: $\geq (2 \times \text{JoinTime}) + 60$.
- To minimize the volume of rejoining data packets generated following a LeaveAll event, specify the value for the LeaveAll timer larger than the LeaveTime value.

Table

For information on how to customize the appearance of the table, see [“Working with tables” on page 16](#).

Port

Displays the port number.

Join time [1/100s]

Specifies the Join timer which controls the interval between transmit opportunities applied to the Applicant state machine.

Possible values:

▶ 10..100 (default setting: 20)

Leave time [1/100s]

Specifies the Leave timer which controls the period that the Registrar state machine waits in the leave (LV) state before transiting to the empty (MT) state.

Possible values:

▶ 20..600 (default setting: 60)

Leave all time [1/100s]

Specifies the LeaveAll timer which controls the frequency with which the LeaveAll state machine generates LeaveAll PDUs.

Possible values:

▶ 200..6000 (default setting: 1000)

5.5.2 MRP-IEEE Multiple MAC Registration Protocol

[Switching > MRP-IEEE > MMRP]

The Multiple MAC Registration Protocol (MMRP) lets end devices and MAC switches register and de-register group membership and individual MAC address information with switches located in the same LAN. The switches within the LAN disseminate the information through switches that support extended filtering services. Using the MAC address information, MMRP lets you confine multicast traffic to the required areas of a Layer 2 network.

For an example of how MMRP works, consider a security camera mounted on a mast overlooking a building. The camera sends multicast packets onto a LAN. You have 2 end devices installed for surveillance in separate locations. You register the MAC addresses of the camera and the 2 end devices in the same multicast group. You then specify the MMRP settings on the ports to send the multicast group packets to the 2 end devices.

The dialog contains the following tabs:

- ▶ [\[Configuration\]](#)
- ▶ [\[Service requirement\]](#)
- ▶ [\[Statistics\]](#)

[Configuration]

In this tab you select active MMRP port participants and set the device to transmit periodic events. The dialog also lets you enable VLAN registered MAC address broadcasting.

A periodic state machine exists for each port and transmits periodic events regularly to the applicant state machines associated with active ports. Periodic events contain information indicating the status of the devices associated with the active port.

Operation

Operation

Enables/disables the global *MMRP* function in the device. The device participates in MMRP message exchanges.

Possible values:

- ▶ *On*
The device is a normal participant in MMRP message exchanges.
- ▶ *Off* (default setting)
The device ignores MMRP messages.

Configuration

Periodic state machine

Enables/disables the global periodic state machine in the device.

Possible values:

- ▶ *On*
With MMRP *Operation* enabled globally, the device transmits MMRP messages in one-second intervals, on MMRP participating ports.
- ▶ *off* (default setting)
Disables the periodic state machine in the device.

Table

For information on how to customize the appearance of the table, see [“Working with tables” on page 16](#).

Port

Displays the port number.

Active

Activates/deactivates the port MMRP participation.

Possible values:

- ▶ *marked* (default setting)
With MMRP enabled globally and on this port, the device sends and receives MMRP messages on this port.
- ▶ *unmarked*
Disables the port MMRP participation.

Restricted group registration

Activates/deactivates the restriction of dynamic MAC address registration using MMRP on the port.

Possible values:

- ▶ *marked*
If enabled and a static filter entry for the MAC address exists on the VLAN concerned, then the device registers the MAC address attributes dynamically.
- ▶ *unmarked* (default setting)
Activates/deactivates the restriction of dynamic MAC address registration using MMRP on the port.

[Service requirement]

This tab contains forwarding parameters for each active VLAN, specifying the ports on which multicast forwarding applies. The device lets you statically setup VLAN ports as *Forward all* or *Forbidden*. You set the *Forbidden* MMRP service requirement statically only through the Graphical User Interface or Command Line Interface.

A port is setup only as *ForwardAll* or *Forbidden*.

Table

For information on how to customize the appearance of the table, see “Working with tables” on page 16.

VLAN ID

Displays the ID of the VLAN.

<Port number>

Specifies the service requirement handling for the port.

Possible values:

- ▶ **FA**
Specifies the *ForwardAll* traffic setting on the port. The device forwards the data packets destined to MMRP registered multicast MAC addresses on the VLAN. The device forwards the data packets to ports which MMRP has dynamically setup or ports which the administrator has statically setup as *ForwardAll* ports.
- ▶ **F**
Specifies the *Forbidden* traffic setting on the port. The device blocks dynamic MMRP *ForwardAll* service requirements. With *ForwardAll* requests blocked on this port in this VLAN, the device blocks the data packets destined to MMRP registered multicast MAC addresses on this port. Furthermore, the device blocks MMRP service request for changing this value on this port.
- ▶ **-** (default setting)
Disables the forwarding functions on this port.
- ▶ **Learned**
Displays values setup by MMRP service requests.

[Statistics]

Devices on a LAN exchange Multiple MAC Registration Protocol Data Units (MMRPDU) to maintain statuses of devices on an active MMRP port. This tab lets you monitor the MMRP data packets statistics for each port.

Information

Buttons

 Reset statistics

Resets the port statistics counters and the values in the [Last received MAC address](#) column.

Transmitted MMRP PDU

Displays the number of MMRPDUs transmitted in the device.

Received MMRP PDU

Displays the number of MMRPDUs received in the device.

Received bad header PDU

Displays the number of MMRPDUs received with a bad header in the device.

Received bad format PDU

Displays the number of MMRPDUs with a bad data field that were not transmitted in the device.

Transmission failed

Displays the number of MMRPDUs not transmitted in the device.

Table

For information on how to customize the appearance of the table, see [“Working with tables” on page 16](#).

Port

Displays the port number.

Transmitted MMRP PDU

Displays the number of MMRPDUs transmitted on the port.

Received MMRP PDU

Displays the number of MMRPDUs received on the port.

Received bad header PDU

Displays the number of MMRPDUs with a bad header that were received on the port.

Received bad format PDU

Displays the number of MMRPDUs with a bad data field that were not transmitted on the port.

Transmission failed

Displays the number of MMRPDUs not transmitted on the port.

Last received MAC address

Displays the MAC address from which the port last received MMRPDUs.

5.5.3 MRP-IEEE Multiple VLAN Registration Protocol

[Switching > MRP-IEEE > MVRP]

The Multiple VLAN Registration Protocol (MVRP) provides a mechanism that lets you distribute VLAN information and configure VLANs dynamically. For example, when you configure a VLAN on an active MVRP port, the device distributes the VLAN information to other MVRP enabled devices. Using the information received, an MVRP enabled device dynamically generates the VLAN trunks on other MVRP enabled devices as needed.

The dialog contains the following tabs:

- ▶ [\[Configuration\]](#)
- ▶ [\[Statistics\]](#)

[Configuration]

In this tab you select active MVRP port participants and set the device to transmit periodic events.

A periodic state machine exists for each port and transmits periodic events regularly to the applicant state machines associated with active ports. Periodic events contain information indicating the status of the VLANs associated with the active port. Using the periodic events, MVRP enabled switches dynamically maintain the VLANs.

Operation

Operation

Enables/disables the global Applicant Administrative Control which specifies if the Applicant state machine participates in MMRP message exchanges.

Possible values:

- ▶ *On*
Normal Participant. The Applicant state machine participates in MMRP message exchanges.
- ▶ *Off* (default setting)
Non-Participant. The Applicant state machine ignores MMRP messages.

Configuration

Periodic state machine

Enables/disables the periodic state machine in the device.

Possible values:

- ▶ *On*
The periodic state machine is enabled.
With MVRP *Operation* enabled globally, the device transmits MVRP periodic events every 1 s, on MVRP participating ports.
- ▶ *off* (default setting)
The periodic state machine is disabled.
Disables the periodic state machine in the device.

Table

For information on how to customize the appearance of the table, see [“Working with tables” on page 16](#).

Port

Displays the port number.

Active

Activates/deactivates the port MVRP participation.

Possible values:

- ▶ *marked* (default setting)
With MVRP enabled globally and on this port, the device distributes VLAN membership information to MVRP-aware devices connected to this port.
- ▶ *unmarked*
Disables the port MVRP participation.

Restricted VLAN registration

Activates/deactivates the *Restricted VLAN registration* function on this port.

Possible values:

- ▶ *marked*
If enabled and a static VLAN registration entry exists, then the device lets you add a dynamic VLAN for this entry.
- ▶ *unmarked* (default setting)
Disables the *Restricted VLAN registration* function on this port.

[Statistics]

Devices on a LAN exchange Multiple VLAN Registration Protocol Data Units (MVRPDUs) to maintain statuses of VLANs on active ports. This tab lets you monitor the MVRP data packets.

Information

Buttons



Reset statistics

Resets the port statistics counters and the values in the *Last received MAC address* column.

Transmitted MVRP PDU

Displays the number of MVRPDUs transmitted in the device.

Received MVRP PDU

Displays the number of MVRPDUs received in the device.

Received bad header PDU

Displays the number of MVRPDUs received with a bad header in the device.

Received bad format PDU

Displays the number of MVRPDUs with a bad data field that the device blocked.

Transmission failed

Displays the number of detected failures while adding a message into the MVRP queue.

Message queue failures

Displays the number of MVRPDUs that the device blocked.

Table

For information on how to customize the appearance of the table, see [“Working with tables” on page 16](#).

Port

Displays the port number.

Transmitted MVRP PDU

Displays the number of MVRPDUs transmitted on the port.

Received MVRP PDU

Displays the number of MVRPDUs received on the port.

Received bad header PDU

Displays the number of MVRPDUs with a bad header that the device received on the port.

Received bad format PDU

Displays the number of MVRPDUs with a bad data field that the device blocked on the port.

Transmission failed

Displays the number of MVRPDUs that the device blocked on the port.

Registrations failed

Displays the number of unsuccessful registration attempts on the port.

Last received MAC address

Displays the MAC address from which the port last received MVRPDUs.

5.6 GARP

[Switching > GARP]

The Generic Attribute Registration Protocol (GARP) is defined by the IEEE standards association to provide a generic framework so switches can register and deregister attribute values, such as VLAN identifiers and multicast group membership.

When an attribute for a participant is registered or deregistered according to GARP, the participant is modified according to specific rules. The participants are a set of reachable end stations and network devices. The defined set of participants at any given time, along with their attributes, is the reachability tree for the subset of the network topology. The device forwards the data frames only to the registered end stations. The station registration helps prevent attempts to send data to the end stations that are unreachable.

Note: Before you enable the *GMRP* function, verify that the *MMRP* function is disabled.

The menu contains the following dialogs:

► *GVRP*

5.6.1 GVRP

[Switching > GARP > GVRP]

The GARP VLAN Registration Protocol or Generic VLAN Registration Protocol (GVRP) is a protocol that facilitates control of Virtual Local Area Networks (VLANs) within a larger network. GVRP is a Layer 2 network protocol, used to automatically set up devices in a VLAN network.

GVRP is a GARP application that provides IEEE 802.1Q-compliant VLAN pruning, and setting up dynamic VLAN on 802.1Q trunk ports. With GVRP, the device exchanges VLAN configuration information with other GVRP devices. Thus, the device reduces the unnecessary broadcast and unknown unicast traffic. Exchanging VLAN configuration information also lets you dynamically add and manage VLANs connected through the 802.1Q trunk ports.

Operation

Operation

Enables/disables the *GVRP* function globally in the device. The device participates in *GVRP* message exchanges. If the function is disabled, then the device ignores *GVRP* messages.

Possible values:

- ▶ *On*
The *GVRP* function is enabled.
- ▶ *Off* (default setting)
The *GVRP* function is disabled.

Table

For information on how to customize the appearance of the table, see [“Working with tables” on page 16](#).

Port

Displays the port number.

GVRP active

Activates/deactivates the port *GVRP* participation.

The prerequisite is that the *GVRP* function is globally enabled.

Possible values:

- ▶ *marked* (default setting)
The port *GVRP* participation is active.
- ▶ *unmarked*
The port *GVRP* participation is inactive.

5.7 QoS/Priority

[Switching > QoS/Priority]

Communication networks transmit a number of applications at the same time that have different requirements as regards availability, bandwidth and latency periods.

QoS (Quality of Service) is a procedure defined in IEEE 802.1D. It is used to distribute resources in the network. You therefore have the possibility of providing minimum bandwidth for necessary applications. The prerequisite is that the end devices and the devices in the network support prioritized data transmission. Data packets with high priority are given preference when transmitted by devices in the network. You transfer data packets with lower priority when there are no data packets with a higher priority to be transmitted.

The device provides the following setting options:

- You specify how the device evaluates QoS/prioritization information for inbound data packets.
- For outbound packets, you specify which QoS/prioritization information the device writes in the data packet (for example priority for management packets, *Port priority*).

Note: If you use the functions in this menu, then disable the flow control. The flow control is inactive if in the [Switching > Global](#) dialog, [Configuration](#) frame the [Flow control](#) checkbox is unmarked.

The menu contains the following dialogs:

- ▶ [QoS/Priority Global](#)
- ▶ [QoS/Priority Port Configuration](#)
- ▶ [802.1D/p Mapping](#)
- ▶ [IP DSCP Mapping](#)
- ▶ [Queue Management](#)

5.7.1 QoS/Priority Global

[Switching > QoS/Priority > Global]

The device lets you maintain access to the device management, even in situations with heavy utilization. In this dialog, you specify the required QoS/priority settings.

Configuration

VLAN priority for management packets

Specifies the VLAN priority for sending management data packets. Depending on the VLAN priority, the device assigns the data packet to a specific *traffic class* and thus to a specific priority queue of the port.

Possible values:

- ▶ 0..7 (default setting: 0)

In the [Switching > QoS/Priority > 802.1D/p Mapping](#) dialog, you assign a *traffic class* to every VLAN priority.

IP DSCP value for management packets

Specifies the IP DSCP value for sending management data packets. Depending on the IP DSCP value, the device assigns the data packet to a specific *traffic class* and thus to a specific priority queue of the port.

Possible values:

- ▶ 0 (be/cs0)..63 (default setting: 0 (be/cs0))

Some values in the list also have a DSCP keyword, for example 0 (be/cs0), 10 (af11) and 46 (ef). These values are compatible with the *IP Precedence* model.

In the [Switching > QoS/Priority > IP DSCP Mapping](#) dialog you assign a *traffic class* to every IP DSCP value.

Queues per port

Displays the number of priority queues per port.

The device has 8 priority queues per port. You assign every priority queue to a specific *traffic class* (*traffic class* according to IEEE 802.1D).

5.7.2 QoS/Priority Port Configuration

[Switching > QoS/Priority > Port Configuration]

In this dialog, you specify for every port how the device processes received data packets based on their QoS/priority information.

Table

For information on how to customize the appearance of the table, see [“Working with tables” on page 16](#).

Port

Displays the port number.

Port priority

Specifies what VLAN priority information the device writes into a data packet if the data packet contains no priority information. After this, the device forwards the data packet depending on the value specified in the *Trust mode* column.

Possible values:

- ▶ 0..7 (default setting: 0)

Trust mode

Specifies how the device handles a received data packet if the data packet contains QoS/priority information.

Possible values:

- ▶ *untrusted*
The device forwards the data packet according to the priority specified in the *Port priority* column. The device ignores the priority information contained in the data packet.
In the [Switching > QoS/Priority > 802.1D/p Mapping](#) dialog, you assign a *traffic class* to every VLAN priority.
- ▶ *trustDot1p* (default setting)
The device forwards the data packet according to the priority information in the VLAN tag.
In the [Switching > QoS/Priority > 802.1D/p Mapping](#) dialog, you assign a *traffic class* to every VLAN priority.
- ▶ *trustIpDscp*
 - If the data packet is an IP packet, then:
The device forwards the data packet according to the IP DSCP value contained in the data packet.
In the [Switching > QoS/Priority > IP DSCP Mapping](#) dialog you assign a *traffic class* to every IP DSCP value.
 - If the data packet is not an IP packet, then:
The device forwards the data packet according to the priority specified in the *Port priority* column.
In the [Switching > QoS/Priority > 802.1D/p Mapping](#) dialog, you assign a *traffic class* to every VLAN priority.

Untrusted traffic class

Displays the *traffic class* assigned to the VLAN priority information specified in the *Port priority* column. In the [Switching > QoS/Priority > 802.1D/p Mapping](#) dialog, you assign a *traffic class* to every VLAN priority.

Possible values:

▶ 0..7

5.7.3 802.1D/p Mapping

[Switching > QoS/Priority > 802.1D/p Mapping]

The device forwards data packets with a VLAN tag according to the contained QoS/priority information with a higher or lower priority.

In this dialog, you assign a *traffic class* to every VLAN priority. You assign the *traffic classes* to the priority queues of the ports.

Table

For information on how to customize the appearance of the table, see [“Working with tables” on page 16](#).

VLAN priority

Displays the VLAN priority.

Traffic class

Specifies the *traffic class* assigned to the VLAN priority.

Possible values:

- ▶ 0..7
 - 0 assigned to the priority queue with the lowest priority.
 - 7 assigned to the priority queue with the highest priority.

Note: Among other things redundancy mechanisms use the highest *traffic class*. Therefore, select another *traffic class* for application data.

Default assignment of the VLAN priority to traffic classes

VLAN Priority	Traffic class	Content description according to IEEE 802.1D
0	2	Best Effort Normal data without prioritizing
1	0	Background Non-time-sensitive data and background services
2	1	Standard Normal data
3	3	Excellent Effort Crucial data
4	4	Controlled Load Time-sensitive data with a high priority
5	5	Video Video transmission with delays and jitter <100 ms
6	6	Voice Voice transmission with delays and jitter <10 ms
7	7	Network Control Data for network management and redundancy mechanisms

5.7.4 IP DSCP Mapping

[Switching > QoS/Priority > IP DSCP Mapping]

The device forwards IP data packets according to the DSCP value contained in the data packet with a higher or lower priority.

In this dialog, you assign a *traffic class* to every DSCP value. You assign the *traffic classes* to the priority queues of the ports.

Table

For information on how to customize the appearance of the table, see [“Working with tables” on page 16](#).

DSCP value

Displays the DSCP value.

Traffic class

Specifies the *traffic class* which is assigned to the DSCP value.

Possible values:

▶ 0..7

0 assigned to the priority queue with the lowest priority.

7 assigned to the priority queue with the highest priority.

Default assignment of the DSCP values to traffic classes

DSCP Value	DSCP Name	Traffic class
0	Best Effort /CS0	2
1-7		2
8	CS1	0
9,11,13,15		0
10,12,14	AF11,AF12,AF13	0
16	CS2	1
17,19,21,23		1
18,20,22	AF21,AF22,AF23	1
24	CS3	3
25,27,29,31		3
26,28,30	AF31,AF32,AF33	3
32	CS4	4
33,35,37,39		4
34,36,38	AF41,AF42,AF43	4
40	CS5	5
41,42,43,44,45,47		5
46	EF	5

DSCP Value	DSCP Name	Traffic class
48	CS6	6
49-55		6
56	CS7	7
57-63		7

5.7.5 Queue Management

[Switching > QoS/Priority > Queue Management]

This dialog lets you enable and disable the *Strict priority* function for the *traffic classes*. When you disable the *Strict priority* function, the device processes the priority queues of the ports with *Weighted Fair Queuing*.

You also have the option of assigning a minimum bandwidths to every *traffic classes* which the device uses to process the priority queues with *Weighted Fair Queuing*.

Table

For information on how to customize the appearance of the table, see [“Working with tables” on page 16](#).

Traffic class

Displays the *traffic class*.

Strict priority

Activates/deactivates the processing of the port priority queue with *Strict priority* for this *traffic class*.

Possible values:

- ▶ **marked** (default setting)
The processing of the port priority queue with *Strict priority* is active.
 - The port forwards only data packets that are in the priority queue with the highest priority. When this priority queue is empty, the port forwards data packets that are in the priority queue with the next lower priority.
 - The port forwards data packets with a lower *traffic class* after the priority queues with a higher priority are empty. In unfavorable situations, the port does not send these data packets.
 - When you select this setting for a *traffic class*, the device also enables the function for *traffic classes* with a higher priority.
 - Use this setting for applications such as VoIP or video that require the least possible delay.
- ▶ **unmarked**
The processing of the port priority queue with *Strict priority* is inactive. The device uses *Weighted Fair Queuing*/"Weighted Round Robin" (WRR) to process the port priority queue.
 - The device assigns a minimum bandwidth to each *traffic class*.
 - Even under a high network load the port transmits data packets with a low *traffic class*.
 - When you select this setting for a *traffic class*, the device also disables the function for *traffic classes* with a lower priority.

Min. bandwidth [%]

Specifies the minimum bandwidth for this *traffic class* when the device is processing the priority queues of the ports with *Weighted Fair Queuing*.

Possible values:

- ▶ 0..100 (default setting: 0 = the device does not reserve any bandwidth for this *traffic class*)

The value specified in percent refers to the available bandwidth on the port. When you disable the *Strict priority* function for every *traffic class*, the maximum bandwidth is available on the port for the *Weighted Fair Queuing*.

The maximum total of the assigned bandwidths is 100 %.

Max. bandwidth [%]

Specifies the shaping rate at which a *traffic class* transmits packets (Queue Shaping).

Possible values:

- ▶ 0 (default setting)
The device does not reserve any bandwidth for this *traffic class*.
- ▶ 1..100
The device reserves the specified bandwidth for this *traffic class*. The specified value in percent refers to the maximum available bandwidth on this port.

For example, using Queue Shaping lets you limit the rate of a strict high-priority queue. Limiting a strict high-priority queue lets the device also process low-priority queues. To use queue shaping, you set the maximum bandwidth for a particular queue.

5.8 VLAN

[Switching > VLAN]

With VLAN (Virtual Local Area Network) you distribute the data packets in the physical network to logical subnets. This provides you with the following advantages:

- High flexibility
 - With VLAN you distribute the data packets to logical networks in the existing infrastructure. Without VLAN, it would be necessary to have additional devices and complicated cabling.
 - With VLAN you specify network segments independently of the location of the individual end devices.
- Improved throughput
 - In VLANs data packets can be transferred by priority.
When the priority is high, the device transfers the data of a VLAN preferentially, for example for time-sensitive applications such as VoIP phone calls.
 - When the data packets and Broadcasts are distributed in small network segments instead of in the entire network, the network load is considerably reduced.
- Increased security
The distribution of the data packets among individual logical networks makes unwanted accessing more difficult and strengthens the system against attacks such as MAC Flooding or MAC Spoofing.

The device supports packet-based “tagged” VLANs according to IEEE 802.1Q. The VLAN tagging in the data packet indicates the VLAN to which the data packet belongs.

The device forwards the tagged data packets of a VLAN only on ports that are assigned to the same VLAN. This reduces the network load.

The device learns the MAC addresses for every VLAN separately (independent VLAN learning).

The device prioritizes the received data stream in the following sequence:

- Voice VLAN
- Port-based VLAN

The menu contains the following dialogs:

- ▶ [VLAN Global](#)
- ▶ [VLAN Configuration](#)
- ▶ [VLAN Port](#)
- ▶ [VLAN Voice](#)

5.8.1 VLAN Global

[Switching > VLAN > Global]

This dialog lets you view general VLAN parameters for the device.

Configuration

Buttons

 Reset VLAN settings

Resets the VLAN settings of the device to the default setting.

Note that you lose your connection to the device if you have changed the VLAN for the device management in the [Basic Settings > Network > Global](#) dialog.

Max. VLAN ID

Highest ID assignable to a VLAN.

See the [Switching > VLAN > Configuration](#) dialog.

VLANs (max.)

Displays the maximum number of VLANs possible.

See the [Switching > VLAN > Configuration](#) dialog.

VLANs

Number of VLANs currently set up in the device.

See the [Switching > VLAN > Configuration](#) dialog.

The VLAN 1 is permanently set up in the device.

5.8.2 VLAN Configuration

[Switching > VLAN > Configuration]

In this dialog, you manage the VLANs. To set up a VLAN, add a further table row. There you specify for each port if it transmits data packets of the respective VLAN and if the data packets contain a VLAN tag.

You distinguish between the following VLANs:

- The user sets up static VLANs.
- The device sets up dynamic VLANs automatically and removes them if the prerequisites cease to apply.

For the following functions the device sets up dynamic VLANs:

- *MRP*: If you assign to the ring ports a non-existing VLAN, then the device sets up this VLAN.
- *MVRP*: The device sets up a VLAN based on the messages of neighboring devices.

Note: The settings are effective only if the *VLAN-unaware mode* function is inactive. See the [Switching > Global](#) dialog.

Table

For information on how to customize the appearance of the table, see [“Working with tables” on page 16](#).

Buttons



Add

Opens the [Create](#) window to add a table row.

In the [VLAN ID](#) field, you specify the VLAN ID.



Remove

Removes the selected table row.

VLAN ID

ID of the VLAN.

The device supports up to 512 VLANs simultaneously set up.

Possible values:

- ▶ [1..4042](#)

Status

Displays how the VLAN is set up.

Possible values:

- ▶ [other](#)
VLAN 1
or
VLAN set up using the [802.1X](#) function. See the [Network Security > 802.1X](#) dialog.
- ▶ [permanent](#)
VLAN set up by the user.
or
VLAN set up using the [MRP](#) function. See the [Switching > L2-Redundancy > MRP](#) dialog.
If you save the settings in the non-volatile memory, then the VLANs with this setting remain set up after a restart.
- ▶ [dynamicMvrp](#)
VLAN set up using the [MVRP](#) function. See the [Switching > MRP-IEEE > MVRP](#) dialog.
VLANs with this setting are write-protected. The device removes a VLAN from the table as soon as the last port leaves the VLAN.

Name

Specifies the name of the VLAN.

Possible values:

- ▶ Alphanumeric ASCII character string with 1..32 characters

<Port number>

Specifies if the respective port transmits data packets of the VLAN and if the data packets contain a VLAN tag.

Possible values:

- ▶ - (default setting)
The port is not a member of the VLAN and does not transmit data packets of the VLAN.
- ▶ **T** = Tagged
The port is a member of the VLAN and transmits the data packets with a VLAN tag. You use this setting for uplink ports, for example.
- ▶ **LT** = Tagged Learned
The port is a member of the VLAN and transmits the data packets with a VLAN tag.
The device has automatically set up the entry based on the [GVRP](#) or [MVRP](#) function.
- ▶ **F** = Forbidden
The port is not a member of the VLAN and does not transmit data packets of this VLAN.
Additionally, the device helps prevent the port from becoming a VLAN member through the [MVRP](#) function.
- ▶ **U** = Untagged (default setting for VLAN 1)
The port is a member of the VLAN and transmits the data packets without a VLAN tag. Use this setting if the connected device does not evaluate any VLAN tags, for example on end ports.
- ▶ **LU** = Untagged Learned
The port is a member of the VLAN and transmits the data packets without a VLAN tag.
The device has automatically set up the entry based on the [GVRP](#) or [MVRP](#) function.

Note: Verify that the port on which the network management station is connected is a member of the VLAN in which the device transmits the management data. In the default setting, the device transmits the management data on VLAN 1. Otherwise, the connection to the device terminates when you transfer the changes to the device. The access to the device management is possible only using the Command Line Interface through the serial interface.

5.8.3 VLAN Port

[Switching > VLAN > Port]

In this dialog, you specify how the device handles received data packets that have no VLAN tag, or whose VLAN tag differs from the VLAN ID of the port.

This dialog lets you assign a VLAN to the ports and thus specify the port VLAN ID.

Additionally, you also specify for each port how the device forwards data packets if the *VLAN-unaware mode* function is inactive and one of the following situations occurs:

- The port receives data packets without a VLAN tagging.
- The port receives data packets with VLAN priority information (VLAN ID 0, priority tagged).
- The VLAN ID in the tag of the data packet differs from the VLAN ID of the port.

Note: The settings are effective only if the *VLAN-unaware mode* function is inactive. See the [Switching > Global](#) dialog.

Table

For information on how to customize the appearance of the table, see [“Working with tables” on page 16](#).

Port

Displays the port number.

Port-VLAN ID

Specifies the VLAN ID which the device assigns to data packets received without a VLAN tag.

Prerequisites:

- In the *Acceptable packet types* column, the value *admitALL* is specified.

Possible values:

- ▶ *1..4042* (default setting: 1)
A VLAN you set up.

If you use the *MRP* function and you did not assign a VLAN to the ring ports, then you specify the value 1 here for the ring ports. Otherwise, the device assigns the value to the ring ports automatically.

Acceptable packet types

Specifies if the port transmits or discards received data packets without a VLAN tag.

Possible values:

- ▶ *admitALL* (default setting)
The port accepts data packets both with and without a VLAN tag.
- ▶ *admitOnlyVlanTagged*
The port accepts only data packets tagged with a VLAN ID ≥ 1 .

Ingress filtering

Activates/deactivates the ingress filtering.

Possible values:

▶ **marked**

The ingress filtering is active.

The device compares the VLAN ID in the data packet with the VLANs of which the port is a member. See the [Switching > VLAN > Configuration](#) dialog. If the VLAN ID in the data packet matches one of these VLANs, then the device forwards the data packet. Otherwise, the device discards the data packet.

▶ **unmarked** (default setting)

The ingress filtering is inactive.

The device forwards received data packets without comparing the VLAN ID. Thus, the device also forwards data packets in VLANs in which the port is not a member.

5.8.4 VLAN Voice

[Switching > VLAN > Voice]

Use the Voice VLAN feature to separate voice and data packets on a port, by VLAN and/or priority. A primary benefit of Voice VLAN is safeguarding the quality of voice data when the port has a high load.

The device detects VoIP phones using the Link Layer Discovery Protocol - Media Endpoint Discovery (LLDP-MED). The device then adds the appropriate port to the member set of the set-up Voice VLAN. The member set is either tagged or untagged. Tagging depends on the Voice VLAN interface mode (*vlan*, *dot1p-priority*, *none*, *untagged*).

Another benefit of the Voice VLAN feature is that the VoIP phone obtains VLAN ID or priority information from the device using LLDP-MED. As a result, the VoIP phone sends voice data packets with VLAN tag, priority tag or untagged. This depends on the specified Voice VLAN Interface mode. You activate Voice VLAN on the port which is connecting to the VoIP phone.

Operation

Operation

Enables/disables the *Voice* function of the device globally.

Possible values:

- ▶ *On*
- ▶ *Off* (default setting)

Table

For information on how to customize the appearance of the table, see [“Working with tables” on page 16](#).

Port

Displays the port number.

Voice VLAN mode

Specifies if the port transmits or discards received data packets without voice VLAN tagging or with voice VLAN priority information.

Possible values:

- ▶ *disabled* (default setting)
Deactivates the *Voice* function for this table row.
- ▶ *none*
Lets the IP telephone use its own configuration for sending untagged voice data packets.
- ▶ *vlan/dot1p-priority*
The port filters data packets of the voice VLAN using the *vlan* and *dot1p* priority tags.
- ▶ *untagged*
The port filters data packets without a voice VLAN tag.

▶ *vlan*

The port filters data packets of the voice VLAN using the vlan tag.

▶ *dot1p-priority*

The port filters data packets of the voice VLAN using the dot1p priority tags. If you select this value, then additionally specify a proper value in the *Priority* column.

Data priority mode

Specifies the trust mode for the data packets on the particular port.

The device uses this mode for data packets on the voice VLAN, when it detects a VoIP telephone and a PC using the same cable for transmitting data.

Possible values:

▶ *marked* (default setting)

If voice data packets are present on the interface, then the data packets have the normal priority.

▶ *unmarked*

If voice data packets are present and the value *dot1p-priority* is specified in the *Voice VLAN mode* column, then the data packets have the priority 0. If the interface only transmits data, then the data has the normal priority.

Status

Displays the status of the Voice VLAN on the port.

Possible values:

▶ *marked*

The Voice VLAN is enabled.

▶ *unmarked*

The Voice VLAN is disabled.

VLAN ID

Specifies the VLAN ID to which the table row relates. To forward data packets to this VLAN using this filter, select in the *Voice VLAN mode* column the value *vlan*.

Possible values:

▶ *1..4042* (default setting: 0)

Priority

Specifies the Voice VLAN Priority of the port.

Prerequisites:

- In the *Voice VLAN mode* column, the value *dot1p-priority* is specified.

Possible values:

▶ *0..7*

▶ *none*

Deactivates the Voice VLAN Priority of the port.

DSCP

Specifies the IP DSCP value.

Possible values:

- ▶ [0 \(be/cs0\)..\[63\]\(#\)](#) (default setting: [0 \(be/cs0\)](#))

Some values in the list also have a DSCP keyword, for example [0 \(be/cs0\)](#), [10 \(af11\)](#) and [46 \(ef\)](#). These values are compatible with the *IP Precedence* model.

In the [Switching > QoS/Priority > IP DSCP Mapping](#) dialog you assign a *traffic class* to every IP DSCP value.

Bypass authentication

Activates the Voice VLAN Authentication mode.

If you deactivate the function and set the value in the *Voice VLAN mode* column to [dot1p-priority](#), then voice devices require an authentication.

Possible values:

- ▶ [marked](#) (default setting)
If you activated the function in the [Network Security > 802.1X > Global](#) dialog, then set the *Port control* parameter for this port to the [multiClient](#) value before activating this function. You find the *Port control* parameter in the [Network Security > 802.1X > Global](#) dialog.
- ▶ [unmarked](#)

5.9 L2-Redundancy

[Switching > L2-Redundancy]

The menu contains the following dialogs:

- ▶ [MRP](#)
- ▶ [Spanning Tree](#)
- ▶ [Link Aggregation](#)
- ▶ [Link Backup](#)

5.9.1 MRP

[Switching > L2-Redundancy > MRP]

The Media Redundancy Protocol (MRP) is a protocol that lets you set up high-availability, ring-shaped network structures. An MRP Ring with Hirschmann devices is made up of up to 100 devices that support the Media Redundancy Protocol (MRP) according to IEC 62439.

If a section is not operating, then the ring structure of an MRP Ring changes back into a line structure. You can specify the maximum recovery time.

The *Ring Manager* device closes the ends of a backbone in a line structure to a redundant ring.

Note: *Spanning Tree* and Ring Redundancy have an effect on each other. Deactivate the *Spanning Tree* function for the ports connected to the MRP Ring. See the *Switching > L2-Redundancy > Spanning Tree > Port* dialog.

When you work with oversized Ethernet packets (the value in the *MTU* column for the port is >1518, see the *Basic Settings > Port* dialog), the switching time of the MRP Ring reconfiguration depends on the following parameters:

- Bandwidth of the ring line
- Size of the Ethernet packets
- Number of devices in the ring

Set the recovery time sufficiently large to help avoid delays in the MRP packages due to latencies in the devices. You can find the formula for calculating the switching time in IEC 62439-2, section 9.5.

Operation

Buttons

 Delete ring configuration

Disables the redundancy function and resets the settings in the dialog to the default setting.

Operation

Enables/disables the *MRP* function.

After you set up the parameters for the MRP Ring, enable the function here.

Possible values:

- ▶ *On*
The *MRP* function is enabled.
After you set up the devices in the MRP Ring, the redundancy is active.
- ▶ *Off* (default setting)
The *MRP* function is disabled.

Ring port 1/Ring port 2

Port

Specifies the number of the port that is operating as a ring port.

Possible values:

- ▶ `<Port number>`
Number of the ring port

Operation

Displays the operating status of the ring port.

Possible values:

- ▶ `forwarding`
The port is enabled, connection exists.
- ▶ `blocked`
The port is blocked, connection exists.
- ▶ `disabled`
The port is disabled.
- ▶ `not-connected`
No connection exists.

Fixed backup

Activates/deactivates the *Backup port* function for the *Ring port 2*.

Note: The switch over to the *Primary port* can exceed the maximum ring recovery time.

Possible values:

- ▶ `marked`
The *Ring port 2* backup function is active. When the ring is closed, the *Ring Manager* device reverts back to the primary ring port.
- ▶ `unmarked` (default setting)
The *Ring port 2* backup function is inactive. When the ring is closed, the *Ring Manager* device continues to send data on the secondary ring port.

Configuration

Ring manager

Enables/disables the *Ring manager* function.

If there is one device at each end of the line, then you activate this function.

Possible values:

- ▶ *On*
The *Ring manager* function is enabled.
The device operates in the *Ring Manager* mode.
To help avoid unexpected behavior, do not enable the function on a device on which the *RCP* function is enabled.
- ▶ *Off* (default setting)
The *Ring manager* function is disabled.
The device operates exclusively in the *Ring Client* mode.

Advanced mode

Activates/deactivates the *Advanced mode* for fast recovery times.

Possible values:

- ▶ *marked* (default setting)
Advanced mode active.
MRP-capable Hirschmann devices support this mode.
- ▶ *unmarked*
Advanced mode inactive.
Select this setting if another device in the ring does not support this mode.

Ring recovery

Specifies the maximum recovery time in milliseconds for reconfiguration of the ring. This setting is effective only if the device operates in the *Ring Manager* mode.

Possible values:

- ▶ *500ms*
- ▶ *200ms* (default setting)

Shorter switching times make greater demands on the response time of every individual device in the ring. Use values lower than *500ms* if the other devices in the ring also support this shorter recovery time.

When you are working with oversized Ethernet packets, the number of devices in the ring is limited. Note that the switching time depends on several parameters. See the description above.

VLAN ID

Specifies the VLAN ID which you assign to the ring ports.

Possible values:

- ▶ *0* (default setting)
No VLAN assigned.
Assign in the *Switching > VLAN > Configuration* dialog to the ring ports for VLAN *1* the value *U*.
- ▶ *1..4042*
VLAN assigned.
If you assign to the ring ports a non-existing VLAN, then the device sets up this VLAN. In the *Switching > VLAN > Configuration* dialog, the device adds a table row for the VLAN and assigns the value *T* to the ring ports.

Information

Information

Displays messages for the redundancy configuration and the possible causes of detected errors.

When the device operates in the *Ring Client* or *Ring Manager* mode, the following messages are possible:

- ▶ *Redundancy available*
The redundancy is set up. When a component of the ring becomes inoperable, the redundant line takes over its function.
- ▶ *Configuration error: Error on ringport link.*
An error is detected in the cabling of the ring ports.

When the device operates in the *Ring Manager* mode, the following messages are possible:

- ▶ *Configuration error: Packets from another ring manager received.*
Another device exists in the ring that operates in the *Ring Manager* mode. Enable the *Ring manager* function only on one device in the ring.
- ▶ *Configuration error: Ring link is connected to wrong port.*
A line in the ring is connected with a different port instead of with a ring port. The device only receives test data packets on one ring port.

5.9.2 Spanning Tree

[Switching > L2-Redundancy > Spanning Tree]

The Spanning Tree Protocol (STP) is a protocol that deactivates redundant paths of a network to help avoid loops. If a network component becomes inoperable on the path, then the device calculates the new topology and reactivates these paths.

The Rapid Spanning Tree Protocol (RSTP) enables fast switching to a newly calculated topology without interrupting existing connections. RSTP gets average reconfiguration times of less than a second. When you use RSTP in a ring with 10 to 20 devices, you can get reconfiguration times in the order of milliseconds.

Note: When you connect the device to the network through twisted-pair SFPs instead of through usual twisted-pair ports, the reconfiguration of the network takes slightly longer.

The menu contains the following dialogs:

- ▶ [Spanning Tree Global](#)
- ▶ [Spanning Tree Port](#)

5.9.2.1 Spanning Tree Global

[Switching > L2-Redundancy > Spanning Tree > Global]

In this dialog, you enable/disable the *Spanning Tree* function and specify the bridge settings.

Operation

Operation

Enables/disables the Spanning Tree function in the device.

Possible values:

▶ *On* (default setting)

▶ *Off*

The device behaves transparently. The device floods received Spanning Tree data packets like multicast data packets to the ports.

Variant

Variant

Displays the protocol used for the *Spanning Tree* function:

Possible values:

▶ *rstp*

The protocol *RSTP* is active.

With RSTP (IEEE 802.1Q-2005), the *Spanning Tree* function operates for the underlying physical layer.

Traps

Send trap

Activates/deactivates the sending of SNMP traps for the following events:

- Another bridge takes over the *Root bridge* role.
- The topology changes. A port changes its *Port state* from *forwarding* into *discarding* or from *discarding* into *forwarding*.

Possible values:

▶ *marked* (default setting)

The sending of SNMP traps is active.

▶ *unmarked*

The sending of SNMP traps is inactive.

Bridge configuration

Bridge ID

Displays the *Bridge Identifier* of the device.

The device with the numerically lowest *Bridge Identifier* value takes over the role of the *Root bridge* in the network.

Possible values:

- ▶ `<Bridge priority> / <MAC address>`
Value in the *Priority* field / MAC address of the device

Priority

Specifies the *Bridge priority* of the device.

Possible values:

- ▶ `0..61440` in steps of 4096 (default setting: `32768 (215)`)

To make this device the *Root bridge*, assign the numerically lowest value for the priority in the network to the device.

Hello time [s]

Specifies the time in seconds between the sending of two configuration messages (Hello data packets).

Possible values:

- ▶ `1..2` (default setting: `2`)

If the device takes over the role of the *Root bridge*, then the other devices in the network use the value specified here.

Otherwise, the device uses the value that the *Root bridge* specifies. See the *Root information* frame.

Due to the interaction with the *Tx holds* parameter, we recommend that you do not change the default setting.

Forward delay [s]

Specifies the delay time for the status change in seconds.

Possible values:

- ▶ `4..30` (default setting: `15`)

If the device takes over the role of the *Root bridge*, then the other devices in the network use the value specified here.

Otherwise, the device uses the value that the *Root bridge* specifies. See the *Root information* frame.

In the Rapid Spanning Tree Protocol (RSTP), the bridges negotiate a status change without a specified delay.

The *Spanning Tree* function uses the parameter to delay the status change between the statuses *disabled*, *discarding*, *learning*, *forwarding*.

The parameters *Forward delay [s]* and *Max age* have the following relationship:

$$\text{Forward delay [s]} \geq (\text{Max age}/2) + 1$$

If you enter values in the fields that contradict this relationship, then the device replaces these values with the last valid values or with the default value.

Max age

Specifies the maximum permitted branch length, namely the number of devices to the *Root bridge*.

Possible values:

- ▶ 6..40 (default setting: 20)

If the device takes over the role of the *Root bridge*, then the other devices in the network use the value specified here.

Otherwise, the device uses the value that the *Root bridge* specifies. See the *Root information* frame.

The *Spanning Tree* function uses the parameter to specify the validity of STP-BPDUs in seconds.

Tx holds

Limits the maximum transmission rate for sending BPDUs.

Possible values:

- ▶ 1..40 (default setting: 10)

When the device sends a BPDU, the device increments a counter on this port.

When the counter reaches the value specified here, the port stops sending BPDUs. On the one hand, this reduces the load generated by RSTP, and on the other when the device does not receive BPDUs, a communication interruption can be caused.

The device decrements the counter by 1 every second. In the following second, the device sends a maximum of 1 new BPDU.

BPDU guard

Activates/deactivates the *BPDU guard* function in the device.

With this function, the device helps protect the network from incorrect configurations, attacks with STP-BPDUs, and unwanted topology changes.

Possible values:

- ▶ **marked**
The *BPDU guard* is active.
 - The device applies the function to manually specified *Edge ports*. For these ports, in the *Switching > L2-Redundancy > Spanning Tree > Port* dialog, *CIST* tab the checkbox in the *Admin edge port* column is marked.
 - If an *Edge port* receives an STP-BPDU, then the device disables the port. For this port, in the *Basic Settings > Port* dialog, *Configuration* tab the checkbox in the *Port on* column is unmarked.
- ▶ **unmarked** (default setting)
The *BPDU guard* is inactive.

To reset the status of the port to the value *forwarding*, you proceed as follows:

- If the port is still receiving BPDUs:
 - In the [Switching > L2-Redundancy > Spanning Tree > Port](#) dialog, *CIST* tab unmark the checkbox in the *Admin edge port* column.
 - or
 - In the [Switching > L2-Redundancy > Spanning Tree > Global](#) dialog, unmark the *BPDU guard* checkbox.
- To re-enable the port again you use the *Auto-Disable* function. As an alternative, proceed as follows:
 - Open the [Basic Settings > Port](#) dialog, *Configuration* tab.
 - Mark the checkbox in the *Port on* column.

BPDU filter (all admin edge ports)

Activates/deactivates the STP-BPDU filter on every manually specified *Edge port*. For these ports, in the [Switching > L2-Redundancy > Spanning Tree > Port](#) dialog, *CIST* tab the checkbox in the *Admin edge port* column is marked.

Possible values:

- ▶ **marked**
 - The BPDU filter is active on every *Edge port*.
 - The function does not use these ports in *Spanning Tree* operations.
 - The device does not send STP-BPDUs on these ports.
 - The device drops any STP-BPDUs received on these ports.
- ▶ **unmarked** (default setting)
 - The global BPDU filter is inactive.
 - You have the option to explicitly activate the BPDU filter for single ports. See the *Port BPDU filter* column in the [Switching > L2-Redundancy > Spanning Tree > Port](#) dialog.

Auto-disable

Activates/deactivates the *Auto-Disable* function for the parameters that *BPDU guard* is monitoring on the port.

Possible values:

- ▶ **marked**
 - The *Auto-Disable* function for the *BPDU guard* is active.
 - When the port receives an STP-BPDU, the device disables an *Edge port*. The Link status LED for the port flashes 3× per period.
 - The [Diagnostics > Ports > Auto-Disable](#) dialog displays which ports are currently disabled due to the parameters being exceeded.
 - After a waiting period, the *Auto-Disable* function enables the port again automatically. For this you go to the [Diagnostics > Ports > Auto-Disable](#) dialog and specify a waiting period for the relevant port in the *Reset timer [s]* column.
- ▶ **unmarked** (default setting)
 - The *Auto-Disable* function for the *BPDU guard* is inactive.

Root information

Root ID

Displays the *Bridge Identifier* of the current *Root bridge*.

Possible values:

▶ <Bridge priority> / <MAC address>

Priority

Displays the *Bridge priority* of the current *Root bridge*.

Possible values:

▶ 0..61440 in steps of 4096

Hello time [s]

Displays the time in seconds that the *Root bridge* specifies between the sending of two configuration messages (Hello data packets).

Possible values:

▶ 1..2

The device uses this specified value. See the *Bridge configuration* frame.

Forward delay [s]

Displays the delay time in seconds set up by the *Root bridge* for status changes.

Possible values:

▶ 4..30

The device uses this specified value. See the *Bridge configuration* frame.

In the Rapid Spanning Tree Protocol (RSTP), the bridges negotiate a status change without a specified delay.

The *Spanning Tree* function uses the parameter to delay the status change between the statuses *disabled*, *discarding*, *learning*, *forwarding*.

Max age

Specifies the maximum permitted branch length that the *Root bridge* sets up, namely the number of devices to the *Root bridge*.

Possible values:

▶ 6..40 (default setting: 20)

The *Spanning Tree* function uses the parameter to specify the validity of STP-BPDUs in seconds.

Topology information

Bridge is root

Displays if the device currently has the role of the *Root bridge*.

Possible values:

- ▶ **marked**
The device currently has the role of the *Root bridge*.
- ▶ **unmarked**
Another device currently has the role of the *Root bridge*.

Root port

Displays the number of the port from which the current path leads to the *Root bridge*.

If the device takes over the role of the *Root bridge*, then the field displays the value **no Port**.

Root path cost

Displays the path cost for the path that leads from the *Root port* of the device to the *Root bridge* of the layer 2 network.

Possible values:

- ▶ **0**
The device takes over the role of the *Root bridge*.
- ▶ **1..200000000 (2 × 10⁸)**

Topology changes

Displays how many times the device has put a port into the *forwarding* status using the *Spanning Tree* function since the *Spanning Tree* instance was started.

Time since topology change

Displays the time since the last topology change.

Possible values:

- ▶ **<days, hours:minutes:seconds>**

5.9.2.2 Spanning Tree Port

[Switching > L2-Redundancy > Spanning Tree > Port]

In this dialog, you activate the Spanning Tree function on the ports, specify *Edge ports*, and specify the settings for various protection functions.

The dialog contains the following tabs:

- ▶ [CIST]
- ▶ [Guards]

[CIST]

In this tab you have the option to activate the Spanning Tree function on the ports individually, specify the settings for *Edge ports*, and view the current values. The abbreviation CIST stands for *Common and Internal Spanning Tree*.

Note: Deactivate the *Spanning Tree* function on the ports that are participating in other Layer 2 redundancy protocols. Otherwise, it is possible that the redundancy protocols operate differently than intended. This can cause loops.

Table

For information on how to customize the appearance of the table, see [“Working with tables” on page 16](#).

Port

Displays the port number.

STP active

Activates/deactivates the *Spanning Tree* function on the port.

Possible values:

- ▶ *marked* (default setting)
The *Spanning Tree* function is active on the port.
- ▶ *unmarked*
The *Spanning Tree* function is inactive on the port.
If the *Spanning Tree* function is enabled in the device and inactive on the port, then the port does not send STP-BPDUs and drops any STP-BPDUs received.

Port state

Displays the transmission status of the port.

Possible values:

- ▶ *discarding*
The port is blocked and forwards only STP-BPDUs.
- ▶ *Learning*
The port is blocked, but it learns the MAC addresses of received data packets.

- ▶ *forwarding*
The port forwards data packets.
- ▶ *disabled*
The port is inactive. See the *Basic Settings > Port* dialog, *Configuration* tab.
- ▶ *manualFwd*
The *Spanning Tree* function is disabled on the port. The port forwards STP-BPDUs.
- ▶ *notParticipate*
The port is not participating in STP.

Port role

Displays the current role of the port in the CIST.

Possible values:

- ▶ *root*
Port with the cheapest path to the *Root bridge*.
- ▶ *alternate*
Port with the alternative path to the *Root bridge* (currently blocking).
- ▶ *designated*
Port for the side of the tree averted from the *Root bridge* (currently blocking).
- ▶ *backup*
Port receives STP-BPDUs from its own device.
- ▶ *disabled*
The port is inactive. See the *Basic Settings > Port* dialog, *Configuration* tab.

Port path cost

Specifies the path costs of the port.

Possible values:

- ▶ *0..200000000* (2×10^8) (default setting: *0*)

When the value is *0*, the device automatically calculates the path costs depending on the data rate of the port.

Port priority

Specifies the priority of the port.

Possible values:

- ▶ *0..240* in steps of 16 (default setting: *128*)

This value represents the first 4 bits of the port ID.

Received bridge ID

Displays the *Bridge Identifier* of the device from which this port last received an STP-BPDU.

Possible values:

- ▶ For ports with the *designated* role, the device displays the information for the STP-BPDU last received by the port. This helps to diagnose the detected STP problems in the network.
- ▶ For the *alternate*, *backup*, *master*, and *root* port roles, in the stationary condition (static topology) this information is identical to the information of the *designated* port role.
- ▶ If a port has no connection or if it did not receive any STP-BPDUs yet, then the device displays the values that the port can send with the *designated* role.

Received port ID

Displays the port ID of the device from which this port last received an STP-BPDU.

Possible values:

- ▶ For ports with the *designated* role, the device displays the information for the STP-BPDU last received by the port. This helps to diagnose the detected STP problems in the network.
- ▶ For the *alternate*, *backup*, *master*, and *root* port roles, in the stationary condition (static topology) this information is identical to the information of the *designated* port role.
- ▶ If a port has no connection or if it did not receive any STP-BPDUs yet, then the device displays the values that the port can send with the *designated* role.

Received path cost

Displays the path cost that the higher-level bridge has from its *Root port* to the *Root bridge*.

Possible values:

- ▶ For ports with the *designated* role, the device displays the information for the STP-BPDU last received by the port. This helps to diagnose the detected STP problems in the network.
- ▶ For the *alternate*, *backup*, *master*, and *root* port roles, in the stationary condition (static topology) this information is identical to the information of the *designated* port role.
- ▶ If a port has no connection or if it did not receive any STP-BPDUs yet, then the device displays the values that the port can send with the *designated* role.

Admin edge port

Activates/deactivates the *Admin edge port* mode. If the port is connected to an end device, then use the *Admin edge port* mode. This setting lets the *Edge port* change faster to the *forwarding* state after linkup and thus a faster accessibility of the end device.

Possible values:

- ▶ **marked**
The *Admin edge port* mode is active.
The port is connected to an end device.
 - After the connection is set up, the port changes to the *forwarding* state without changing to the *Learning* state beforehand.
 - If the port receives an STP-BPDU and the *BPDU guard* function is active, then the device deactivates the port. See the [Switching > L2-Redundancy > Spanning Tree > Global](#) dialog.
- ▶ **unmarked** (default setting)
The *Admin edge port* mode is inactive.
The port is connected to another STP bridge.
After the connection is set up, the port changes to the *Learning* status before changing to the *forwarding* state, if applicable.

Auto edge port

Activates/deactivates the automatic detection of whether you connect an end device to the port. The prerequisite is that the checkbox in the *Admin edge port* column is unmarked.

Possible values:

- ▶ **marked** (default setting)
The automatic detection is active.
After the installation of the connection and after $1.5 \times \textit{Hello time [s]}$, the device sets the port to the *forwarding* status (default setting 1.5×2 s) if the port did not receive any STP-BPDUs during this time.
- ▶ **unmarked**
The automatic detection is inactive.
After the installation of the connection, and after *Max age* the device sets the port to the *forwarding* status.
(default setting: 20 s)

Oper edge port

Displays if an end device or an STP bridge is connected to the port.

Possible values:

- ▶ **marked**
An end device is connected to the port. The port does not receive any STP-BPDUs.
- ▶ **unmarked**
An STP bridge is connected to the port. The port receives STP-BPDUs.

Oper PointToPoint

Displays if the port is connected to an STP device through a direct full-duplex link.

Possible values:

- ▶ **marked**
The port is connected directly to an STP device through a full-duplex link. The direct, decentralized communication between 2 bridges provides short reconfiguration times.
- ▶ **unmarked**
The port is connected in another way, for example through a half-duplex link or through a hub.

Port BPDU filter

Activates/deactivates the filtering of STP-BPDUs on the port explicitly.

The prerequisite is that the port is a manually specified *Edge port*. For these ports, the checkbox in the *Admin edge port* column is marked.

Possible values:

- ▶ **marked**
The BPDU filter is active on the port.
The function excludes the port from *Spanning Tree* operations.
 - The device does not send STP-BPDUs on the port.
 - The device drops any STP-BPDUs received on the port.
- ▶ **unmarked** (default setting)
The BPDU filter is inactive on the port.
You have the option to globally activate the BPDU filter for every *Edge port*. See the *Switching > L2-Redundancy > Spanning Tree > Global* dialog, *Bridge configuration* frame.
If the *BPDU filter (all admin edge ports)* checkbox is marked, then the BPDU filter is still active on the port.

BPDU filter status

Displays if the BPDU filter is active on the port.

Possible values:

▶ **marked**

The BPDU filter is active on the port as a result of the following settings:

- The checkbox in the *Port BPDU filter* column is marked.
and/or
- The checkbox in the *BPDU filter (all admin edge ports)* column is marked. See the *Switching > L2-Redundancy > Spanning Tree > Global* dialog, *Bridge configuration* frame.

▶ **unmarked**

The BPDU filter is inactive on the port.

BPDU flood

Activates/deactivates the *BPDU flood* mode on the port even if the *Spanning Tree* function is inactive on the port. The device floods STP-BPDUs received on the port to the ports for which the *Spanning Tree* function is inactive and the *BPDU flood* mode is active too.

Possible values:

▶ **marked**

The *BPDU flood* mode is active.

▶ **unmarked** (default setting)

The *BPDU flood* mode is inactive.

[Guards]

This tab lets you specify the settings for various protection functions on the ports.

Table

For information on how to customize the appearance of the table, see [“Working with tables” on page 16](#).

Port

Displays the port number.

Root guard

Activates/deactivates the monitoring of STP-BPDUs on the port. The prerequisite is that the *Loop guard* function is inactive.

With this setting the device helps you protect the network from incorrect configurations or attacks with STP-BPDUs that try to change the topology. This setting is relevant only for ports with the STP role *designated*.

Possible values:

- ▶ **marked**
The monitoring of STP-BPDUs is active.
 - If the port receives an STP-BPDU with better path information to the *Root bridge*, then the device discards the STP-BPDU and sets the status of the port to the value *discarding* instead of *root*.
 - If there are no STP-BPDUs with better path information to the *Root bridge*, then the device resets the status of the port after $2 \times$ *Hello time [s]*.
- ▶ **unmarked** (default setting)
The monitoring of STP-BPDUs is inactive.

TCN guard

Activates/deactivates the monitoring of *Topology Change* notifications on the port. With this setting the device helps you protect the network from attacks with STP-BPDUs that try to change the topology.

Possible values:

- ▶ **marked**
The monitoring of *Topology Change* notifications is active.
 - The port ignores the *Topology Change* flag in received STP-BPDUs.
 - If the received BPDU contains other information that causes a topology change, then the device processes the BPDU even if the *TCN guard* function is active.
Example: The device receives better path information for the *Root bridge*.
- ▶ **unmarked** (default setting)
The monitoring of *Topology Change* notifications is inactive.
If the device receives STP-BPDUs with a *Topology Change* flag, then the device deletes the MAC address table (forwarding database) of the port and forwards the *Topology Change* notifications.

Loop guard

Activates/deactivates the monitoring of loops on the port. The prerequisite is that the *Root guard* function is inactive.

With this setting the device helps prevent loops if the port does not receive any more STP-BPDUs. Use this setting only for ports with the STP role *alternate*, *backup* or *root*.

Possible values:

- ▶ **marked**
The monitoring of loops is active. This helps prevent loops for example, if you disable the Spanning Tree function on the remote device or if the connection is interrupted only in the receiving direction.
 - If the port does not receive any STP-BPDUs for a while, then the device sets the status of the port to the value *discarding* and marks the checkbox in the *Loop state* column.
 - If the port receives STP-BPDUs again, then the device sets the status of the port to a value according to *Port role* and unmarks the checkbox in the *Loop state* column.
- ▶ **unmarked** (default setting)
The monitoring of loops is inactive.
If the port does not receive any STP-BPDUs for a while, then the device sets the status of the port to the value *forwarding*.

Loop state

Displays if the loop state of the port is inconsistent.

Possible values:

▶ **marked**

The loop state of the port is inconsistent:

- The port is not receiving any STP-BPDUs and the *Loop guard* function is enabled.
- The device sets the state of the port to the value *discarding*. The device thus helps prevent any potential loops.

▶ **unmarked**

The loop state of the port is consistent. The port receives STP-BPDUs.

Trans. into loop

Displays how many times the loop state of the port became inconsistent (marked checkbox in the *Loop state* column).

Trans. out of loop

Displays how many times the loop state of the port became consistent (unmarked checkbox in the *Loop state* column).

BPDU guard effect

Displays if the port received an STP-BPDU as an *Edge port*.

Prerequisite:

- The port is a manually specified *Edge port*. In the *Switching > L2-Redundancy > Spanning Tree > Port* dialog, the checkbox for this port in the *Admin edge port* column is marked.
- In the *Switching > L2-Redundancy > Spanning Tree > Global* dialog, the *BPDU guard* function is active.

Possible values:

▶ **marked**

The port is an *Edge port* and received an STP-BPDU.

The device deactivates the port. For this port, in the *Basic Settings > Port* dialog, *Configuration* tab the checkbox in the *Port on* column is unmarked.

▶ **unmarked**

The port is an *Edge port* and has not received any STP-BPDUs, or the port is not an *Edge port*.

To reset the status of the port to the value *forwarding*, you proceed as follows:

- If the port is still receiving BPDUs:
 - In the *CIST* tab, unmark the checkbox in the *Admin edge port* column.
 - or
 - In the *Switching > L2-Redundancy > Spanning Tree > Global* dialog, unmark the *BPDU guard* checkbox.
- To activate the port, proceed as follows:
 - Open the *Basic Settings > Port* dialog, *Configuration* tab.
 - Mark the checkbox in the *Port on* column.

5.9.3 Link Aggregation

[Switching > L2-Redundancy > Link Aggregation]

The *Link Aggregation* function lets you aggregate multiple parallel links. The prerequisite is that the links have the same speed and are full-duplex. The advantages compared to conventional connections using a single line are higher availability and a higher transmission bandwidth.

The criteria for distributing the load to the parallel links are based on the *Hashing option* function.

The Link Aggregation Control Protocol (LACP) makes it possible to monitor the packet-based continuous link status on the physical ports. LACP also helps ensure that the link partners meet the aggregation prerequisites.

If the remote side does not support the Link Aggregation Control Protocol (LACP), then you can use the *Static link aggregation* function. In this case, the device aggregates the links based on the link, link speed and duplex setting.

Configuration

Hashing option

Specifies which information the device uses to distribute the packets to the physical ports of the LAG interface. The device sends packets containing the same distribution-relevant information over the same physical port to keep the packet order.

This setting overwrites the value specified in the *Hashing option* column for the port.

Possible values:

- ▶ *sourceMacVlan*
The device uses the *Source MAC address*, *VLAN ID*, *EtherType* fields of the packet, and the physical ingress port.
- ▶ *destMacVlan*
The device uses the *Destination MAC address*, *VLAN ID*, *EtherType* fields of the packet, and the physical ingress port.
- ▶ *sourceDestMacVlan* (default setting)
The device uses the *Source MAC address*, *Destination MAC address*, *VLAN ID*, *EtherType* fields of the packet, and the physical ingress port.
- ▶ *sourceIPsourcePort*
The device uses the *Source IP address* and *Source TCP/UDP port* fields of the packet.
- ▶ *destIPdestPort*
The device uses the *Destination IP address* and *Destination TCP/UDP port* fields of the packet.
- ▶ *sourceDestIPPort*
The device uses the *Source IP address*, *Destination IP address*, *Source TCP/UDP port*, and *Destination TCP/UDP port* fields of the packet.

Table

For information on how to customize the appearance of the table, see “Working with tables” on page 16.

Buttons



Add

Opens the [Create](#) window to add a table row for a LAG interface or to assign a physical port to a LAG interface.

- From the [Trunk port](#) drop-down list, you select the LAG interface number.
- From the [Port](#) drop-down list, you select the number of a physical port to assign to the LAG interface.

After you set up a LAG interface, the device adds the LAG interface to the table in the [Basic Settings > Port](#) dialog, [Statisticstab](#).



Remove

Removes the selected table row.

Trunk port

Displays the LAG interface number.

Name

Specifies the name of the LAG interface.

Possible values:

- ▶ Alphanumeric ASCII character string with 1..15 characters

Link/Status

Displays the current operating state of the LAG interface and the physical ports.

Possible values:

- ▶ [up](#) ([lag/...](#) row)
The LAG interface is operational.
The prerequisites are:
 - The [Static link aggregation](#) function is active on this LAG interface.
 - or
 - LACP is active on the physical ports assigned to the LAG interface, see the [LACP active](#) column.
 - and
 - The key specified for the LAG interface in the [LACP admin key](#) column matches the keys specified for the physical ports in the [LACP port actor admin key](#) column.
 - and
 - The number of operational physical ports assigned to the LAG interface is greater than or equal to the value specified in the [Active ports \(min.\)](#) column.
- ▶ [up](#)
The physical port is operational.

- ▶ *down* (lag/... row)
The LAG interface is inoperable.
- ▶ *down*
The physical port is disabled.
or
No cable connected or no active link.

Active

Activates/deactivates the LAG interface.

Possible values:

- ▶ *marked* (default setting)
The LAG interface is active.
Consider that the following protocols do not work properly on the physical ports when you activate the LAG interface:
 - *PTP*
- ▶ *unmarked*
The LAG interface is inactive.

STP active

Activates/deactivates the *Spanning Tree* function on this LAG interface. The prerequisite is that in the [Switching > L2-Redundancy > Spanning Tree > Global](#) dialog the *Spanning Tree* function is enabled.

You can also activate/deactivate the *Spanning Tree* function on the LAG interfaces in the [Switching > L2-Redundancy > Spanning Tree > Port](#) dialog.

Possible values:

- ▶ *marked* (default setting)
The *Spanning Tree* function is active on this LAG interface.
- ▶ *unmarked*
The *Spanning Tree* function is inactive on this LAG interface.

Static link aggregation

Activates/deactivates the *Static link aggregation* function on the LAG interface. The device aggregates the assigned physical ports to the LAG interface, even if the remote site does not support LACP.

Possible values:

- ▶ *marked*
The *Static link aggregation* function is active on this LAG interface. The device aggregates an assigned physical port to the LAG interface as soon as the physical port gets a link. The device does not send LACPDUs and discards received LACPDUs.
- ▶ *unmarked* (default setting)
The *Static link aggregation* function is inactive on this LAG interface. If the connection was successfully negotiated using LACP, then the device aggregates an assigned physical port to the LAG interface.

Hashing option

Specifies which information the device uses to distribute the packets to the individual physical ports of the LAG interface. This setting has priority over the value selected in the *Configuration* frame, *Hashing option* drop-down list.

For further information on the values, see the description of the *Hashing option* drop-down list in the *Configuration* frame.

MTU

Specifies the maximum allowed size of Ethernet packets on the LAG interface in bytes. Any present VLAN tag is not taken into account.

This setting lets you increase the size of the Ethernet packets for specific applications.

Possible values:

▶ **1518..12288** (default setting: **1518**)

With the value **1518**, the LAG interface transmits the Ethernet packets up to the following size:

- 1518 bytes without VLAN tag
(1514 bytes + 4 bytes CRC)
- 1522 bytes with VLAN tag
(1518 bytes + 4 bytes CRC)

Active ports (min.)

Specifies the minimum number of physical ports to be active for the LAG interface to stay active. If the number of active physical ports is lower than the specified value, then the device deactivates the LAG interface.

If a redundancy function like *Spanning Tree* is active in the device, then you use this function to force the device to switch automatically to the redundant line.

Possible values:

▶ **1..4** (default setting: **1**)

Depending on the hardware, the upper value can be greater than **4**, for example **8** or **32**.

Type

Displays if the LAG interface is based on the *Static link aggregation* function or on LACP.

Possible values:

▶ *static*

The LAG interface is based on the *Static link aggregation* function.

▶ *dynamic*

The LAG interface is based on LACP.

Send trap (Link up/down)

Activates/deactivates the sending of SNMP traps when the device detects a change in the link up/down status for this interface.

Possible values:

- ▶ **marked** (default setting)
The sending of SNMP traps is active. The prerequisite is that in the [Diagnostics > Status Configuration > Alarms \(Traps\)](#) dialog the [Alarms \(Traps\)](#) function is enabled and at least one trap destination is specified.
When the device detects a link up/down status change, the device sends an SNMP trap.
- ▶ **unmarked**
The sending of SNMP traps is inactive.

LACP admin key

Specifies the LAG interface key. The device uses this key to identify the ports that can be aggregated to the LAG interface.

Possible values:

- ▶ **0..65535** ($2^{16}-1$)
You specify the corresponding value for the physical ports in the [LACP port actor admin key](#) column.

Port

Displays the physical port number assigned to the LAG interface.

Aggregation port status

Displays if the LAG interface aggregates the physical port.

Possible values:

- ▶ **active**
The LAG interface aggregates the physical port.
- ▶ **inactive**
The LAG interface does not aggregate the physical port.

LACP active

Activates/deactivates LACP on the physical port.

Possible values:

- ▶ **marked** (default setting)
LACP is active on the physical port.
- ▶ **unmarked**
LACP is inactive on the physical port.

LACP port actor admin key

Specifies the physical port key. The device uses this key to identify the ports that can be aggregated to the LAG interface.

Possible values:

- ▶ 0
The device ignores the key on this physical port when deciding to aggregate the port into the LAG interface.
- ▶ 1..65535 ($2^{16}-1$)
If this value matches the value of the LAG interface specified in the *LACP admin key* column, then the device only aggregates this physical port to the LAG interface.

LACP actor admin state

Specifies the actor state values that the LAG interface transmits in the LACPDUs. This lets you control the LACPDU parameters.

The device lets you mix the values. From the drop-down list, select one or more items.

Possible values:

- ▶ *ACT*
(*LACP_Activity* state)
When selected, the link transmits the LACPDUs cyclically, otherwise when requested.
- ▶ *STO*
(*LACP_Timeout* state)
When selected, the link transmits the LACPDUs cyclically using the short timeout, otherwise using the long timeout.
- ▶ *AGG*
(*Aggregation* state)
When selected, the device interprets the link as a candidate for aggregation, otherwise as an individual link.

For further information on the values, see IEEE 802.1AX-2014.

LACP actor oper state

Displays the actor state values that the LAG interface transmits in the LACPDUs.

Possible values:

- ▶ *ACT*
(*LACP_Activity* state)
When visible, the link transmits the LACPDUs cyclically, otherwise when requested.
- ▶ *STO*
(*LACP_Timeout* state)
When visible, the link transmits the LACPDUs cyclically using the short timeout, otherwise using the long timeout.
- ▶ *AGG*
(*Aggregation* state)
When visible, the device interprets the link as a candidate for aggregation, otherwise as an individual link.
- ▶ *SYN*
(*Synchronization* state)
When visible, the device interprets the link as *IN_SYNC*, otherwise as *OUT_OF_SYNC*.

- ▶ *COL*
(Collecting state)
When visible, collection of incoming frames is enabled on this link, otherwise disabled.
- ▶ *DST*
(Distributing state)
When visible, distribution of outgoing frames is enabled on this link, otherwise disabled.
- ▶ *DFT*
(Defaulted state)
When visible, the link uses defaulted operational information, administratively specified for the Partner. Otherwise the link uses the operational information received from a LACPDU.
- ▶ *EXP*
(Expired state)
When visible, the link receiver is in the **EXPIRED** state.

LACP partner oper SysID

Displays the MAC address of the remote device connected to this physical port.

The LAG interface has received this information in a LACPDU from the partner.

LACP partner oper port

Displays the port number of the remote device connected to this physical port.

The LAG interface has received this information in a LACPDU from the partner.

LACP partner oper port state

Displays the partner state values that the LAG interface receives in the LACPDUs.

Possible values:

- ▶ *ACT*
- ▶ *STO*
- ▶ *AGG*
- ▶ *SYN*
- ▶ *COL*
- ▶ *DST*
- ▶ *DFT*
- ▶ *EXP*

For further information on the values, see the description of the *LACP actor oper state* column and IEEE 802.1AX-2014.

5.9.4 Link Backup

[Switching > L2-Redundancy > Link Backup]

With Link Backup, you set up pairs of redundant links. Each pair has a *Primary port* and a *Backup port*. The *Primary port* forwards the data packets until the device detects an error. If the device detects an error on the *Primary port*, then the Link Backup function transfers the data packets over to the *Backup port*.

The dialog also lets you set a fail back option. When you activate the *Fail back* function and the *Primary port* returns to normal operation, the device first blocks the data packets on the *Backup port* and then forwards the data packets to the *Primary port*. This process helps protect the device from causing loops in the network.

Operation

Operation

Enables/disables the Link Backup function globally in the device.

Possible values:

- ▶ *On*
Enables the Link Backup function.
- ▶ *Off* (default setting)
Disables the Link Backup function.

Table

For information on how to customize the appearance of the table, see [“Working with tables” on page 16](#).

Buttons



Add

Adds a table row.



Remove

Removes the selected table row.

Primary port

Displays the *Primary port* of the interface pair. When you enable the Link Backup function, this port is responsible for forwarding the data packets.

Possible values:

- ▶ Physical ports

Backup port

Displays the *Backup port* to which the device forwards the data packets if the device detects an error on the *Primary port*.

Possible values:

- ▶ Physical ports except for the port you set as the *Primary port*.

Description

Specifies the Link Backup pair. Enter a name to identify the Backup pair.

Possible values:

- ▶ Alphanumeric ASCII character string with 0..255 characters

Primary port status

Displays the status of the *Primary port* for this Link Backup pair.

Possible values:

- ▶ *forwarding*
The link is up, no shutdown, and forwarding data packets.
- ▶ *blocking*
The link is up, no shutdown, and blocking data packets.
- ▶ *down*
The cable is unplugged, the port is powered off, the port link is interrupted, or a function in the device has disabled the port.
- ▶ *unknown*
The Link Backup feature is globally disabled, or the port pair is inactive. Therefore, the device ignores the port pair settings.

Backup port status

Displays the status of the *Backup port* for this Link Backup pair.

Possible values:

- ▶ *forwarding*
The link is up, no shutdown, and forwarding data packets.
- ▶ *blocking*
The link is up, no shutdown, and blocking data packets.
- ▶ *down*
The cable is unplugged, the port is powered off, the port link is interrupted, or a function in the device has disabled the port.
- ▶ *unknown*
The Link Backup feature is globally disabled, or the port pair is inactive. Therefore, the device ignores the port pair settings.

Fail back

Activates/deactivates the automatic fail back.

Possible values:

- ▶ **marked** (default setting)
The automatic fail back is active.
After the delay timer expires, the *Backup port* changes to *blocking* and the *Primary port* changes to *forwarding*.
- ▶ **unmarked**
The automatic fail back is inactive.
The *Backup port* continues forwarding data packets even after the *Primary port* re-establishes a link or you manually change the admin status of the *Primary port* from *shutdown* to *no shutdown*.

Fail back delay [s]

Specifies the delay time in seconds that the device waits after the *Primary port* re-establishes a link. Furthermore, this timer also applies when you manually set the admin status of the *Primary port* from *shutdown* to *no shutdown*. After the delay timer expires, the *Backup port* changes to *blocking* and the *Primary port* changes to *forwarding*.

Possible values:

- ▶ **0..3600** (default setting: 30)
When set to 0, immediately after the *Primary port* re-establishes a link, the *Backup port* changes to *blocking* and the *Primary port* changes to *forwarding*. Furthermore, immediately after you manually set the admin status of from *shutdown* to *no shutdown*, the *Backup port* changes to *blocking* and the *Primary port* changes to *forwarding*.

Active

Activates/deactivates the Link Back up pair configuration.

Possible values:

- ▶ **marked**
The Link Backup pair is active. The device senses the link and administration status and forwards the data packets according to the pair configuration.
- ▶ **unmarked** (default setting)
The Link Backup pair is inactive. The ports forward the data packets according to standard switching.

Create

Primary port

Specifies the *Primary port* of the backup interface pair. During normal operation this port is responsible for forwarding the data packets.

Possible values:

- ▶ Physical ports

Backup port

Specifies the *Backup port* to which the device transfers the data packets to if the device detects an error on the *Primary port*.

Possible values:

- ▶ Physical ports except for the port you set as the *Primary port*.

6 Diagnostics

The menu contains the following dialogs:

- ▶ [Status Configuration](#)
- ▶ [System](#)
- ▶ [Syslog](#)
- ▶ [Ports](#)
- ▶ [LLDP](#)
- ▶ [Report](#)

6.1 Status Configuration

[Diagnostics > Status Configuration]

The menu contains the following dialogs:

- ▶ [Device Status](#)
- ▶ [Security Status](#)
- ▶ [Signal Contact](#)
- ▶ [MAC Notification](#)
- ▶ [Alarms \(Traps\)](#)

6.1.1 Device Status

[Diagnostics > Status Configuration > Device Status]

The device status provides an overview of the overall condition of the device. Many process visualization systems record the device status for a device to present its condition in graphic form.

The device displays its current status as *error* or *ok* in the *Device status* frame. The device determines this status from the individual monitoring results.

The device displays detected faults in the *Status* tab and also in the *Basic Settings > System* dialog, *Device status* frame.

The dialog contains the following tabs:

- ▶ [Global]
- ▶ [Port]
- ▶ [Status]

[Global]

Device status

Device status

Displays the current status of the device. The device determines the status from the individual monitored parameters.

Possible values:

- ▶ *ok*
- ▶ *error*

The device displays this value to indicate a detected error in one of the monitored parameters.

Traps

Send trap

Activates/deactivates the sending of SNMP traps when the device detects a change in a monitored function.

Possible values:

- ▶ *marked* (default setting)
The sending of SNMP traps is active. The prerequisite is that in the *Diagnostics > Status Configuration > Alarms (Traps)* dialog the *Alarms (Traps)* function is enabled and at least one trap destination is specified.
If the device detects a change in the monitored functions, then the device sends an SNMP trap.
- ▶ *unmarked*
The sending of SNMP traps is inactive.

Table

For information on how to customize the appearance of the table, see “Working with tables” on page 16.

Connection errors

Activates/deactivates the monitoring of the link status of the port/interface.

Possible values:

- ▶ **marked**
Monitoring is active.
If the link interrupts on a monitored port/interface, then in the *Device status* frame, the value changes to *error*.
In the *Port* tab, you have the option of selecting the ports/interfaces to be monitored individually.
- ▶ **unmarked** (default setting)
Monitoring is inactive.

Temperature

Activates/deactivates the monitoring of the temperature in the device.

Possible values:

- ▶ **marked** (default setting)
Monitoring is active.
If the temperature exceeds the specified upper threshold value or falls below the specified lower threshold value, then in the *Device status* frame, the value changes to *error*.
- ▶ **unmarked**
Monitoring is inactive.

You specify the temperature threshold values in the *Basic Settings > System* dialog, *Upper temp. limit [°C]* field and *Lower temp. limit [°C]* field.

External memory removal

Activates/deactivates the monitoring of the active external memory.

Possible values:

- ▶ **marked**
Monitoring is active.
If you remove the active external memory from the device, then in the *Device status* frame, the value changes to *error*.
- ▶ **unmarked** (default setting)
Monitoring is inactive.

External memory not in sync

Activates/deactivates the monitoring of the configuration profile in the device and in the external memory.

Possible values:

▶ **marked**

Monitoring is active.

In the *Device status* frame, the value changes to *error* in the following situations:

- The configuration profile only exists in the device.
- The configuration profile in the device differs from the configuration profile in the external memory.

▶ **unmarked** (default setting)

Monitoring is inactive.

Ring redundancy

Activates/deactivates the monitoring of the ring redundancy.

Possible values:

▶ **marked**

Monitoring is active.

In the *Device status* frame, the value changes to *error* in the following situations:

- The redundancy function becomes active (loss of redundancy reserve).
- The device is a normal ring participant and detects an error in its settings.

▶ **unmarked** (default setting)

Monitoring is inactive.

Humidity

Activates/deactivates the monitoring of the humidity in the device.

You specify the humidity threshold values in the *Basic Settings > System* dialog, *Upper humidity limit [%]* field and *Lower humidity limit [%]* field.

Possible values:

▶ **marked** (default setting)

Monitoring is active.

If the humidity exceeds or falls below the specified threshold values, then in the *Device status* frame, the value changes to *error*.

▶ **unmarked**

Monitoring is inactive.

Power supply

Activates/deactivates the monitoring of the power supply unit.

Possible values:

▶ **marked** (default setting)

Monitoring is active.

If the device has a detected power supply fault, then in the *Device status* frame, the value changes to *error*.

▶ **unmarked**

Monitoring is inactive.

[Port]**Table**

For information on how to customize the appearance of the table, see [“Working with tables” on page 16](#).

Port

Displays the port number.

Propagate connection error

Activates/deactivates the monitoring of the link on the port/interface.

Possible values:

▶ **marked**

Monitoring is active.

If the link on the selected port/interface is interrupted, then in the *Device status* frame, the value changes to *error*.

▶ **unmarked** (default setting)

Monitoring is inactive.

This setting takes effect when you mark the *Connection errors* checkbox in the *Global* tab.

[Status]**Table**

For information on how to customize the appearance of the table, see [“Working with tables” on page 16](#).

Timestamp

Displays the date and time of the event in the format, *Month Day, Year hh:mm:ss AM/PM*.

Cause

Displays the event which caused the SNMP trap.

6.1.2 Security Status

[Diagnostics > Status Configuration > Security Status]

This dialog gives you an overview of the status of the safety-relevant settings in the device.

The device displays its current status as *error* or *ok* in the *Security status* frame. The device determines this status from the individual monitoring results.

The device displays detected faults in the *Status* tab and also in the *Basic Settings > System* dialog, *Security status* frame.

The dialog contains the following tabs:

- ▶ [Global]
- ▶ [Port]
- ▶ [Status]

[Global]

Security status

Security status

Displays the current status of the security-relevant settings in the device. The device determines the status from the individual monitored parameters.

Possible values:

- ▶ *ok*
- ▶ *error*

The device displays this value to indicate a detected error in one of the monitored parameters.

Traps

Send trap

Activates/deactivates the sending of SNMP traps when the device detects a change in a monitored function.

Possible values:

- ▶ *marked*

The sending of SNMP traps is active. The prerequisite is that in the *Diagnostics > Status Configuration > Alarms (Traps)* dialog the *Alarms (Traps)* function is enabled and at least one trap destination is specified.

If the device detects a change in the monitored functions, then the device sends an SNMP trap.

- ▶ *unmarked* (default setting)

The sending of SNMP traps is inactive.

Table

For information on how to customize the appearance of the table, see “Working with tables” on page 16.

Password default settings unchanged

Activates/deactivates the monitoring of the password for the locally set up user account `admin`.

Possible values:

- ▶ `marked` (default setting)
Monitoring is active.
If the password is set to the default setting for the `admin` user account, then in the *Security status* frame, the value changes to *error*.
- ▶ `unmarked`
Monitoring is inactive.

You set the password in the *Device Security > User Management* dialog.

Min. password length shorter than 8

Activates/deactivates the monitoring of the *Min. password length* policy.

Possible values:

- ▶ `marked` (default setting)
Monitoring is active.
If the value for the *Min. password length* policy is less than 8, then in the *Security status* frame, the value changes to *error*.
- ▶ `unmarked`
Monitoring is inactive.

You specify the *Min. password length* policy in the *Device Security > User Management* dialog in the *Configuration* frame.

Password policy settings deactivated

Activates/deactivates the monitoring of the Password policies settings.

Possible values:

- ▶ `marked` (default setting)
Monitoring is active.
If the value for at least one of the following policies is less than 1, then in the *Security status* frame, the value changes to *error*.
 - *Upper-case characters (min.)*
 - *Lower-case characters (min.)*
 - *Digits (min.)*
 - *Special characters (min.)*
- ▶ `unmarked`
Monitoring is inactive.

You specify the policy settings in the *Device Security > User Management* dialog in the *Password policy* frame.

User account password policy check deactivated

Activates/deactivates the monitoring of the *Policy check* function.

Possible values:

- ▶ **marked**
Monitoring is active.
If the *Policy check* function is inactive for at least one user account, then in the *Security status* frame, the value changes to *error*.
- ▶ **unmarked** (default setting)
Monitoring is inactive.

You activate the *Policy check* function in the *Device Security > User Management* dialog.

Telnet server active

Activates/deactivates the monitoring of the Telnet server.

Possible values:

- ▶ **marked** (default setting)
Monitoring is active.
If you enable the Telnet server, then in the *Security status* frame, the value changes to *error*.
- ▶ **unmarked**
Monitoring is inactive.

You enable/disable the Telnet server in the *Device Security > Management Access > Server* dialog, *Telnet* tab.

HTTP server active

Activates/deactivates the monitoring of the HTTP server.

Possible values:

- ▶ **marked** (default setting)
Monitoring is active.
If you enable the HTTP server, then in the *Security status* frame, the value changes to *error*.
- ▶ **unmarked**
Monitoring is inactive.

You enable/disable the HTTP server in the *Device Security > Management Access > Server* dialog, *HTTP* tab.

SNMP unencrypted

Activates/deactivates the monitoring of the SNMP server.

Possible values:

▶ **marked** (default setting)

Monitoring is active.

If at least one of the following conditions applies, then in the *Security status* frame, the value changes to *error*:

- The *SNMPv1* function is enabled.
- The *SNMPv2* function is enabled.
- The encryption for SNMPv3 is disabled.

You enable the encryption in the *Device Security > User Management* dialog, in the *SNMP encryption type* column.

▶ **unmarked**

Monitoring is inactive.

You specify the settings for the SNMP agent in the *Device Security > Management Access > Server* dialog, *SNMP* tab.

Access to system monitor with serial interface possible

Activates/deactivates the monitoring of the system monitor.

When the system monitor is active, you have the possibility to change to the system monitor using a serial connection during the system startup.

Possible values:

▶ **marked**

Monitoring is active.

If you activate the system monitor, then in the *Security status* frame, the value changes to *error*.

▶ **unmarked** (default setting)

Monitoring is inactive.

You activate/deactivate the system monitor in the *Diagnostics > System > Selftest* dialog.

Saving the configuration profile on the external memory possible

Activates/deactivates the monitoring of the configuration profile in the external memory.

Possible values:

▶ **marked**

Monitoring is active.

If you activate the saving of the configuration profile in the external memory, then in the *Security status* frame, the value changes to *error*.

▶ **unmarked** (default setting)

Monitoring is inactive.

You activate/deactivate the saving of the configuration profile in the external memory in the *Basic Settings > External Memory* dialog.

Link interrupted on enabled device ports

Activates/deactivates the monitoring of the link on the active ports.

Possible values:

▶ **marked**

Monitoring is active.

If the link interrupts on an active port, then in the *Security status* frame, the value changes to *error*. In the *Port* tab, you have the option of selecting the ports to be monitored individually.

▶ **unmarked** (default setting)

Monitoring is inactive.

Access with HiDiscovery possible

Activates/deactivates the monitoring of the HiDiscovery function.

Possible values:

▶ **marked** (default setting)

Monitoring is active.

If you enable the HiDiscovery function, then in the *Security status* frame, the value changes to *error*.

▶ **unmarked**

Monitoring is inactive.

You enable/disable the HiDiscovery function in the *Basic Settings > Network > Global* dialog.

Load unencrypted config from external memory

Activates/deactivates the monitoring of loading unencrypted configuration profiles from the external memory.

Possible values:

▶ **marked** (default setting)

Monitoring is active.

If the settings allow the device to load an unencrypted configuration profile from the external memory, then in the *Security status* frame, the value changes to *error*.

If the following preconditions are fulfilled, then the *Security status* frame in the *Basic Settings > System* dialog, displays an alarm.

– The configuration profile stored in the external memory is unencrypted.
and

– The *Config priority* column in the *Basic Settings > External Memory* dialog has the value *first*.

▶ **unmarked**

Monitoring is inactive.

Self-signed HTTPS certificate present

Activates/deactivates the monitoring of the digital certificate of the HTTPS server.

Possible values:

▶ **marked** (default setting)

Monitoring is active.

If the HTTPS server uses a self-generated digital certificate, then in the *Security status* frame, the value changes to *error*.

▶ **unmarked**

Monitoring is inactive.

Modbus TCP active

Activates/deactivates the monitoring of the *Modbus TCP* function.

Possible values:

- ▶ *marked* (default setting)

Monitoring is active.

If you enable the *Modbus TCP* function, then in the *Security status* frame, the value changes to *error*.

- ▶ *unmarked*

Monitoring is inactive.

You enable/disable the *Modbus TCP* function in the *Advanced > Industrial Protocols > Modbus TCP* dialog, *Operation* frame.

EtherNet/IP active

Activates/deactivates the monitoring of the *EtherNet/IP* function.

Possible values:

- ▶ *marked* (default setting)

Monitoring is active.

If you enable the *EtherNet/IP* function, then in the *Security status* frame, the value changes to *error*.

- ▶ *unmarked*

Monitoring is inactive.

You enable/disable the *EtherNet/IP* function in the *Advanced > Industrial Protocols > EtherNet/IP* dialog, *Operation* frame.

PROFINET active

Activates/deactivates the monitoring of the *PROFINET* function.

Possible values:

- ▶ *marked* (default setting)

Monitoring is active.

If you enable the *PROFINET* function, then in the *Security status* frame, the value changes to *error*.

- ▶ *unmarked*

Monitoring is inactive.

You enable/disable the *PROFINET* function in the *Advanced > Industrial Protocols > PROFINET* dialog, *Operation* frame.

[Port]**Table**

For information on how to customize the appearance of the table, see [“Working with tables” on page 16](#).

Port

Displays the port number.

Link interrupted on enabled device ports

Activates/deactivates the monitoring of the link on the active ports.

Possible values:

▶ **marked**

Monitoring is active.

If the port is enabled ([Basic Settings > Port](#) dialog, [Configuration](#) tab, [Port on](#) checkbox is **marked**) and the link is down on the port, then in the [Security status](#) frame, the value changes to **error**.

▶ **unmarked** (default setting)

Monitoring is inactive.

This setting takes effect when you mark the [Link interrupted on enabled device ports](#) checkbox in the [Diagnostics > Status Configuration > Security Status](#) dialog, [Global](#) tab.

[Status]**Table**

For information on how to customize the appearance of the table, see [“Working with tables” on page 16](#).

Timestamp

Displays the date and time of the event in the format, [Month Day, Year](#) [hh:mm:ss AM/PM](#).

Cause

Displays the event which caused the SNMP trap.

6.1.3 Signal Contact

[Diagnostics > Status Configuration > Signal Contact]

The signal contact is a potential-free relay contact. The device thus lets you perform remote diagnosis. The device uses the relay contact to signal the occurrence of events by opening the relay contact and interrupting the closed circuit.

Note: The device can contain several signal contacts. Each contact contains the same monitoring functions. Several contacts allow you to group various functions together providing flexibility in system monitoring.

The menu contains the following dialogs:

- ▶ [Signal Contact 1 / Signal Contact 2](#)

6.1.3.1 Signal Contact 1 / Signal Contact 2

[Diagnostics > Status Configuration > Signal Contact > Signal Contact 1]

In this dialog, you specify the trigger conditions for the signal contact.

The signal contact gives you the following options:

- Monitoring the correct operation of the device.
- Signaling the device status of the device.
- Signaling the security status of the device.
- Controlling external devices by manually setting the signal contacts.

The device displays detected faults in the [Status](#) tab and also in the [Basic Settings > System](#) dialog, [Signal contact status](#) frame.

The dialog contains the following tabs:

- ▶ [\[Global\]](#)
- ▶ [\[Port\]](#)
- ▶ [\[Status\]](#)

[Global]

Configuration

Mode

Specifies which events the signal contact indicates.

Possible values:

- ▶ [Manual setting](#) (default setting for [Signal Contact 2](#), if present)
You use this setting to manually open or close the signal contact, for example to turn on or off a remote device. See the [Contact](#) option list.
- ▶ [Monitoring correct operation](#) (default setting)
Using this setting the signal contact indicates the status of the parameters specified in the table below.
- ▶ [Device status](#)
Using this setting the signal contact indicates the status of the parameters monitored in the [Diagnostics > Status Configuration > Device Status](#) dialog. In addition, you can read the status in the [Signal contact status](#) frame.
- ▶ [Security status](#)
Using this setting the signal contact indicates the status of the parameters monitored in the [Diagnostics > Status Configuration > Security Status](#) dialog. In addition, you can read the status in the [Signal contact status](#) frame.
- ▶ [Device/Security status](#)
Using this setting the signal contact indicates the status of the parameters monitored in the [Diagnostics > Status Configuration > Device Status](#) and the [Diagnostics > Status Configuration > Security Status](#) dialog. In addition, you can read the status in the [Signal contact status](#) frame.

Contact

Toggles the signal contact manually. The prerequisite is that from the *Mode* drop-down list the *Manual setting* item is selected.

Possible values:

- ▶ *open*
The signal contact is opened.
- ▶ *close*
The signal contact is closed.

Signal contact status

Signal contact status

Displays the current status of the signal contact.

Possible values:

- ▶ *Opened (error)*
The signal contact is opened. The circuit is interrupted.
- ▶ *Closed (ok)*
The signal contact is closed. The circuit is closed.

Trap configuration

Send trap

Activates/deactivates the sending of SNMP traps when the device detects a change in a monitored function.

Possible values:

- ▶ *marked*
The sending of SNMP traps is active. The prerequisite is that in the *Diagnostics > Status Configuration > Alarms (Traps)* dialog the *Alarms (Traps)* function is enabled and at least one trap destination is specified.
If the device detects a change in the monitored functions, then the device sends an SNMP trap.
- ▶ *unmarked* (default setting)
The sending of SNMP traps is inactive.

Table

For information on how to customize the appearance of the table, see [“Working with tables” on page 16](#).

Connection errors

Activates/deactivates the monitoring of the link status of the port/interface.

Possible values:

- ▶ **marked**
Monitoring is active.
If the link interrupts on a monitored port/interface, then the signal contact opens.
In the *Port* tab, you have the option of selecting the ports/interfaces to be monitored individually.
- ▶ **unmarked** (default setting)
Monitoring is inactive.

Temperature

Activates/deactivates the monitoring of the temperature in the device.

Possible values:

- ▶ **marked** (default setting)
Monitoring is active.
If the temperature exceeds the specified upper threshold value or falls below the specified lower threshold value, then the signal contact opens.
- ▶ **unmarked**
Monitoring is inactive.

You specify the temperature threshold values in the *Basic Settings > System* dialog, *Upper temp. limit [°C]* field and *Lower temp. limit [°C]* field.

Ring redundancy

Activates/deactivates the monitoring of the ring redundancy.

Possible values:

- ▶ **marked**
Monitoring is active.
The signal contact opens in the following situations:
 - The redundancy function becomes active (loss of redundancy reserve).
 - The device is a normal ring participant and detects an error in its settings.
- ▶ **unmarked** (default setting)
Monitoring is inactive.

External memory removed

Activates/deactivates the monitoring of the active external memory.

Possible values:

- ▶ **marked**
Monitoring is active.
If you remove the active external memory from the device, then the signal contact opens.
- ▶ **unmarked** (default setting)
Monitoring is inactive.

External memory not in sync with NVM

Activates/deactivates the monitoring of the configuration profile in the device and in the external memory.

Possible values:

- ▶ **marked**
Monitoring is active.
The signal contact opens in the following situations:
 - The configuration profile only exists in the device.
 - The configuration profile in the device differs from the configuration profile in the external memory.
- ▶ **unmarked** (default setting)
Monitoring is inactive.

Humidity

Activates/deactivates the monitoring of the humidity in the device.

Possible values:

- ▶ **marked** (default setting)
Monitoring is active.
If the humidity exceeds or falls below the specified threshold values, then the signal contact opens.
- ▶ **unmarked**
Monitoring is inactive.

You specify the humidity threshold values in the [Basic Settings > System](#) dialog, [Upper humidity limit \[%\]](#) field and [Lower humidity limit \[%\]](#) field.

Power supply

Activates/deactivates the monitoring of the power supply unit.

Possible values:

- ▶ **marked** (default setting)
Monitoring is active.
If the device has a detected power supply fault, then the signal contact opens.
- ▶ **unmarked**
Monitoring is inactive.

[Port]**Table**

For information on how to customize the appearance of the table, see [“Working with tables” on page 16](#).

Port

Displays the port number.

Propagate connection error

Activates/deactivates the monitoring of the link on the port/interface.

Possible values:

- ▶ **marked**
Monitoring is active.
If the link interrupts on the selected port/interface, then the signal contact opens.
- ▶ **unmarked** (default setting)
Monitoring is inactive.

This setting takes effect when you mark the *Connection errors* checkbox in the *Global* tab.

[Status]**Table**

For information on how to customize the appearance of the table, see “Working with tables” on page 16.

Timestamp

Displays the date and time of the event in the format, *Month Day, Year hh:mm:ss AM/PM*.

Cause

Displays the event which caused the SNMP trap.

6.1.4 MAC Notification

[Diagnostics > Status Configuration > MAC Notification]

The device lets you track changes in the network using the MAC address of the devices in the network. The device saves the combination of port and MAC address in its MAC address table (forwarding database). If the device (un)learns the MAC address of a (dis)connected device, then the device sends an SNMP trap.

This function is intended for ports to which you connect end devices and thus the MAC address changes infrequently.

Operation

Operation

Enables/disables the *MAC Notification* function in the device.

Possible values:

- ▶ *On*
The *MAC Notification* function is enabled.
- ▶ *off* (default setting)
The *MAC Notification* function is disabled.

Configuration

Interval [s]

Specifies the send interval in seconds. If the device (un)learns the MAC address of a (dis)connected device, then the device sends an SNMP trap after this time.

Possible values:

- ▶ 0..2147483647 ($2^{31}-1$) (default setting: 1)

Before sending an SNMP trap, the device registers up to 20 MAC addresses. If the device detects a high number of changes, then the device sends the SNMP trap before the send interval expires.

Table

For information on how to customize the appearance of the table, see [“Working with tables” on page 16](#).

Port

Displays the port number.

Active

Activates/deactivates the *MAC Notification* function on the port.

Possible values:

- ▶ *marked*
The *MAC Notification* function is active on the port.
The device sends an SNMP trap in case of one of the following events:
 - The device learns the MAC address of a newly connected device.
 - The device unlearns the MAC address of a disconnected device.The prerequisite is that in the *Diagnostics > Status Configuration > Alarms (Traps)* dialog the *Alarms (Traps)* function is enabled and at least one trap destination is specified.
- ▶ *unmarked* (default setting)
The *MAC Notification* function is inactive on the port.

Last MAC address

Displays the MAC address of the device last connected on or disconnected from the port.

The device detects the MAC addresses of devices which are connected as follows:

- directly connected to the port
- connected to the port through other devices in the network

Last MAC status

Displays the status of the [Last MAC address](#) value on this port.

Possible values:

- ▶ [added](#)
The device detected that another device was connected at the port.
- ▶ [removed](#)
The device detected that the connected device was removed from the port.
- ▶ [other](#)
The device did not detect a status.

6.1.5 Alarms (Traps)

[Diagnostics > Status Configuration > Alarms (Traps)]

The device lets you send an SNMP trap in response to specific events.

You specify the events for which the device triggers an SNMP trap in the following dialogs:

- [Diagnostics > Status Configuration > Device Status](#)
- [Diagnostics > Status Configuration > Security Status](#)
- [Diagnostics > Status Configuration > MAC Notification](#)

The menu contains the following dialogs:

- ▶ [Trap V3 User Management](#)
- ▶ [Trap Destinations](#)

6.1.5.1 Trap V3 User Management

[Diagnostics > Status Configuration > Alarms (Traps) > Trap V3 User Management]

In this dialog, you specify the SNMPv3 trap users who can send SNMP traps to the trap destination(s). The device supports encrypted SNMPv3 traps and authentication for sending.

SNMPv3 trap users have permission to send SNMPv3 traps to the specified SNMPv3 trap hosts.

SNMPv3 trap users are intended for sending SNMPv3 traps to SNMPv3 trap hosts exclusively. SNMPv3 trap users are different from the user accounts set up in the device. Do not confuse them. See the [Device Security > User Management](#) dialog.

Table

For information on how to customize the appearance of the table, see [“Working with tables” on page 16](#).

Buttons



Add

Opens the [Create](#) window to add a table row. The device adds an SNMPv3 trap user with the parameters you specify in this window.

- From the [User to be cloned](#) drop-down list, you select the user account, from which the device clones the authentication settings.
You need to select one of the user accounts set up in the device. You set up device user accounts in the [Device Security > User Management](#) dialog.
- In the [Trap User name](#) field, you specify the name for the SNMPv3 trap user.
Possible values:
 - ▶ Alphanumeric ASCII character string with 1..32 characters
- From the [Trap User Auth Protocol](#) drop-down list, you select the protocol for sending SNMPv3 traps with authentication.
Possible values:
 - ▶ [none](#)
The device sends SNMPv3 traps unencrypted and without authentication.
 - ▶ [hmacmd5](#)
The device sends SNMPv3 traps using the Message-Digest Algorithm 5 (HMACMD5) protocol.
Available if this protocol is already set for the user to be cloned.
 - ▶ [hmacsha](#)
The device sends SNMPv3 traps using the Secure Hash Algorithm (HMACSHA) protocol.
Available if this protocol is already set for the user to be cloned.
- In the [Trap User Auth Password](#) field, you specify the password that the SNMPv3 trap user uses to authenticate before sending.
Possible values:
 - ▶ Alphanumeric ASCII character string with 8..64 characters
The prerequisite is that from the [Trap User Auth Protocol](#) drop-down list, an item other than [none](#) is selected.
- From the [Trap User Priv Protocol](#) drop-down list, you select the protocol that the device uses for this user to encrypt the SNMPv3 traps.
Possible values:
 - ▶ [none](#) (default setting)
No encryption.

- ▶ [des](#)
Data Encryption Standard (DES).
Available if this protocol is already set for the user to be cloned.
- ▶ [aesCfb128](#)
Advanced Encryption Standard (AES).
Available if this protocol is already set for the user to be cloned.
- In the [Trap User Priv Password](#) field, you specify the password that the SNMPv3 trap user uses to authenticate before sending.
Possible values:
 - ▶ Alphanumeric ASCII character string with 8..64 characters
The prerequisite is that from the [Trap User Auth Protocol](#) drop-down list, an item other than [none](#) is selected.

When you click the [Ok](#) button, the device adds the table row for the SNMPv3 trap user. If you have selected an item other than [none](#) in the [Trap User Auth Protocol](#) or [Trap User Priv Protocol](#) drop-down list, the [Credentials](#) window opens first. Then, you enter the required password(s). Even if you enter an incorrect password, the device still adds the SNMPv3 trap user. However, when the device sends SNMPv3 traps, the trap destination cannot decrypt them.



Remove

Removes the selected table row.

SNMPv3 Notification User

Displays the name of the SNMPv3 trap user.

Authentication

Displays the protocol for sending SNMPv3 traps with authentication in the context of the SNMPv3 trap user.

Auth Password

Displays ***** (asterisks) instead of the authentication password of the SNMPv3 trap user.

To change the password, add another SNMPv3 trap user and then delete the existing one.

Privacy

Displays the protocol that the device uses for this user to encrypt the SNMPv3 traps.

Priv Password

Displays ***** (asterisks) instead of the password that the SNMPv3 trap user uses to authenticate before sending.

To change the password, add another SNMPv3 trap user and then delete the existing one.

User status

Displays the status of the SNMPv3 trap user.

Possible values:

- ▶ **marked** (default setting)
The SNMPv3 trap user is active.
- ▶ **unmarked**
The SNMPv3 trap user is inactive.

6.1.5.2 Trap Destinations

[Diagnostics > Status Configuration > Alarms (Traps) > Trap Destinations]

In this dialog, you specify the trap destinations to which the device sends SNMP traps.

For SNMPv3, the following conditions apply:

- ▶ The device sends SNMPv3 traps to the trap destination specified for the relevant SNMPv3 trap user.
- ▶ The device supports a maximum of 10 trap destinations for SNMPv3.

Operation

Operation

Enables/disables sending SNMP traps.

Possible values:

- ▶ *On* (default setting)
Sending SNMP traps is enabled.
- ▶ *Off*
Sending SNMP traps is disabled.

SNMPv1/v2 trap community

Name

Specifies the community string that the device sends in each SNMPv1/v2 trap for authentication to the trap destination.

Possible values:

- ▶ Alphanumeric ASCII character string with 0..64 characters
trap (default setting)

Table

For information on how to customize the appearance of the table, see [“Working with tables” on page 16](#).

Buttons



Add

Opens the [Create](#) window to add a table row. Thus, you set up a trap destination on the device.

- In the [Name](#) field, you specify a name for the trap destination.
Possible values:
 - ▶ Alphanumeric ASCII character string with 1..32 characters

- From the *Type* drop-down list, you select the SNMP version which the device uses to send SNMP traps to the trap destination.
Possible values:
 - ▶ *V1*
SNMP version 1
For security reasons, we recommend not to use this setting.
 - ▶ *V3*
SNMP version 3
- In the *Address* field, you specify the IP address and the port of the trap destination.
Possible values:
 - ▶ *<IPv4 address>:<port>*
If you do not specify a port, then the device automatically adds port *162* to the trap destination.
- From the *SNMPv3 Trap user* drop-down list, you select the SNMPv3 trap user in whose context the device sends SNMPv3 traps to the trap destination.
The prerequisite is that you select the *V3* item from the *Type* drop-down list.
You select one of the users that you have set up in the *Diagnostics > Status Configuration > Alarms (Traps) > Trap V3 User Management* dialog.
- From the *Security level* drop-down list, you select whether the device sends the SNMPv3 traps encrypted and whether authentication is required before sending.
The prerequisite is that you select the *V3* item from the *Type* drop-down list.
Possible values:
 - ▶ *noAuthNoPriv*
The device sends SNMPv3 traps unencrypted without authentication.
For security reasons, we recommend not to use this setting.
 - ▶ *authNoPriv*
The device sends SNMPv3 traps unencrypted.
The user needs to authenticate before sending SNMPv3 traps.
 - ▶ *authPriv*
The device sends SNMPv3 traps encrypted.
The user needs to authenticate before sending SNMPv3 traps.



Remove

Removes the selected table row.

Name

Displays the name you specified for the SNMPv3 trap destination (trap host).

SNMP Protocol

Displays the SNMP version which the device uses to send SNMP traps to the trap destination.

Address

Specifies the IP address and the port of the trap destination (trap host).

Possible values:

- ▶ *<IPv4 address>:<port>*
If you do not specify a port, then the device automatically adds port *162* to the trap destination.

SNMPv3 Trap user

Specifies the SNMPv3 trap user that the device uses to send SNMPv3 traps to the trap destination.

You select one of the SNMPv3 trap users that you have set up in the [Diagnostics > Status Configuration > Alarms \(Traps\) > Trap V3 User Management](#) dialog.

Security level

Specifies whether the device sends the SNMPv3 traps encrypted and whether authentication is required before sending.

Possible values:

- ▶ [noAuthNoPriv](#)
The device sends SNMPv3 traps unencrypted without authentication.
For security reasons, we recommend not to use this setting.
- ▶ [authNoPriv](#)
The device sends SNMPv3 traps unencrypted.
The user needs to authenticate before sending SNMPv3 traps.
- ▶ [authPriv](#)
The device sends SNMPv3 traps encrypted.
The user needs to authenticate before sending SNMPv3 traps.

Type

Displays the notification type.

Active

Activates/deactivates the sending of SNMP traps to the trap destination.

Possible values:

- ▶ [marked](#) (default setting)
The sending of SNMP traps to this trap destination is active.
- ▶ [unmarked](#)
The sending of SNMP traps to this trap destination is inactive.

6.2 System

[Diagnostics > System]

The menu contains the following dialogs:

- ▶ [System Information](#)
- ▶ [Hardware State](#)
- ▶ [Configuration Check](#)
- ▶ [IP Address Conflict Detection](#)
- ▶ [ARP](#)
- ▶ [Selftest](#)

6.2.1 System Information

[Diagnostics > System > System Information]

This dialog displays the current operating condition of individual components in the device. The displayed values are a snapshot; they represent the operating condition at the time the dialog was loaded to the page.

Buttons

 Save system information

Saves the HTML page on your PC using the web browser dialog.

6.2.2 Hardware State

[Diagnostics > System > Hardware State]

This dialog provides information about the distribution and state of the flash memory of the device.

Information

Operating hours

Displays the total operating time of the device since it was delivered.

Possible values:

▶ `..d ..h ..m ..s`
Day(s) Hour(s) Minute(s) Second(s)

Table

For information on how to customize the appearance of the table, see [“Working with tables” on page 16](#).

Flash region

Displays the name of the parameter, for example for the relevant memory area.

Description

Displays a description for the parameter.

Flash sectors

Displays how many sectors are assigned to the memory area.

Sector erase operations

Displays how many times the device has overwritten the sectors of the memory area.

6.2.3 Configuration Check

[Diagnostics > System > Configuration Check]

The device lets you compare the settings in the device with the settings in its neighboring devices. For this purpose, the device uses the information that it received from its neighboring devices through topology recognition (LLDP).

The dialog lists the detected deviations, which affect the performance of the communication between the device and the recognized neighboring devices.

Note: A neighboring device without LLDP support, which forwards LLDP packets, can be the cause of equivocal messages in the dialog. This occurs if the neighboring device is a hub or a switch without management, which ignores IEEE 802.1D-2004. In this case, the dialog displays the devices recognized and connected to the neighboring device as connected to the device itself, even though they are connected to the neighboring device.

Configuration

Start configuration check...

Starts the check and updates the content of the table.

When the table remains empty, the configuration check was successful and the settings in the device are compatible with the settings in the detected neighboring devices.

Information



Error

Displays the number of **ERROR** level deviations that the device detected during the configuration check.



Warning

Displays the number of **WARNING** level deviations that the device detected during the configuration check.

If you have set up more than 39 VLANs in the device, then the dialog continuously displays a warning. The reason is the limited number of possible VLAN data sets in LLDP packets with a maximum length. The device compares the first 39 VLANs automatically. If you have set up 40 or more VLANs in the device, then check the congruence of the further VLANs manually, if necessary.



Information

Displays the number of **INFORMATION** level deviations that the device detected during the configuration check.

Table

For information on how to customize the appearance of the table, see [“Working with tables” on page 16](#).



Displays detailed information about the detected deviations in the area below the table row. To hide the detailed information again, click the  button. If you click the icon in the table header, you display or hide the detailed information for each table row.

ID

Displays the rule ID of the deviations having occurred. The dialog combines several deviations with the same rule ID under one rule ID.

Level

Displays the level of deviation between the settings in this device and the settings in the detected neighboring devices.

The device differentiates between the following access statuses:

- **INFORMATION**
The performance of the communication between the two devices is not impaired.
- **WARNING**
The performance of the communication between the two devices is possibly impaired.
- **ERROR**
The communication between the two devices is impaired.

Message

Displays a summary of the detected deviations.

6.2.4 IP Address Conflict Detection

[Diagnostics > System > IP Address Conflict Detection]

Using the *IP Address Conflict Detection* function the device verifies that its IP address is unique in the network. For this purpose, the device analyzes received ARP packets.

In this dialog, you specify the procedure with which the device detects address conflicts and specify the required settings for this.

The device displays detected address conflicts in the table.

When the device detects an address conflict, the status LED of the device flashes red 4 times.

Operation

Operation

Enables/disables the *IP Address Conflict Detection* function.

Possible values:

- ▶ *On* (default setting)
The *IP Address Conflict Detection* function is enabled.
The device verifies that its IP address is unique in the network.
- ▶ *Off*
The *IP Address Conflict Detection* function is disabled.

Information

Conflict detected

Displays if an address conflict currently exists.

Possible values:

- ▶ *marked*
The device detects an address conflict.
- ▶ *unmarked*
The device does not detect an address conflict.

Configuration

Detection mode

Specifies the procedure with which the device detects address conflicts.

Possible values:

- ▶ *active and passive* (default setting)
The device uses active and passive address conflict detection.

▶ *active*

Active address conflict detection. The device actively helps avoid communicating with an IP address that already exists in the network. The address conflict detection begins as soon as you connect the device to the network or change its IP parameters.

- The device sends 4 ARP probe data packets at the interval specified in the *Detection delay [ms]* field. If the device receives a response to these data packets, then there is an address conflict.
- If the device does not detect an address conflict, then it sends 2 gratuitous ARP data packets as an announcement. The device also sends these data packets when the address conflict detection is disabled.
- If the IP address already exists in the network, then the device changes back to the previously used IP parameters (if possible).
If the device receives its IP parameters from a DHCP server, then it sends a DHCPDECLINE message back to the DHCP server.
- After the period specified in the *Release delay [s]* field, the device checks if the address conflict still exists. When the device detects 10 address conflicts one after the other, the device extends the waiting time to 60 s for the next check.
- When the device resolves the address conflict, the device management returns to the network again.

▶ *passive*

Passive address conflict detection. The device analyzes the data stream in the network. If another device in the network is using the same IP address, then the device initially “defends” its IP address. The device stops sending if the other device keeps sending with the same IP address.

- As a “defence” the device sends gratuitous ARP data packets. The device repeats this procedure for the number of times specified in the *Address protections* field.
- If the other device continues sending with the same IP address, then after the period specified in the *Release delay [s]* field, the device periodically checks if the address conflict still exists.
- When the device resolves the address conflict, the device management returns to the network again.

Send periodic ARP probes

Activates/deactivates the periodic address conflict detection.

Possible values:

▶ *marked* (default setting)

The periodic address conflict detection is active.

- The device periodically sends an ARP probe data packet every 90 to 150 seconds and waits for the time specified in the *Detection delay [ms]* field for a response.
- If the device detects an address conflict, then the device applies the passive detection mode function. If the *Send trap* function is active, then the device sends an SNMP trap.

▶ *unmarked*

The periodic address conflict detection is inactive.

Detection delay [ms]

Specifies the period in milliseconds for which the device waits for a response after sending a ARP data packets.

Possible values:

- ▶ 20..500 (default setting: 200)

Release delay [s]

Specifies the period in seconds after which the device checks again if the address conflict still exists.

Possible values:

- ▶ 3..3600 (default setting: 15)

Address protections

Specifies how many times the device sends gratuitous ARP data packets in the passive detection mode to “defend” its IP address.

Possible values:

- ▶ 0..100 (default setting: 1)

Protection interval [ms]

Specifies the period in milliseconds after which the device sends gratuitous ARP data packets again in the passive detection mode to “defend” its IP address.

Possible values:

- ▶ 20..10000 (default setting: 10000)

Send trap

Activates/deactivates the sending of SNMP traps when the device detects an address conflict.

Possible values:

- ▶ **marked** (default setting)
The sending of SNMP traps is active. The prerequisite is that in the [Diagnostics > Status Configuration > Alarms \(Traps\)](#) dialog the [Alarms \(Traps\)](#) function is enabled and at least one trap destination is specified.
If the device detects an address conflict, then the device sends an SNMP trap.
- ▶ **unmarked**
The sending of SNMP traps is inactive.

Table

For information on how to customize the appearance of the table, see [“Working with tables” on page 16](#).

Timestamp

Displays the time at which the device detected an address conflict.

Port

Displays the number of the port on which the device detected the address conflict.

IP address

Displays the IP address that is causing the address conflict.

MAC address

Displays the MAC address of the device with which the address conflict exists.

6.2.5 ARP

[Diagnostics > System > ARP]

This dialog displays the MAC and IP addresses of the neighboring devices connected to the device management.

The device can display both IPv4 and IPv6 addresses. For IPv6, the device obtains the addresses of the neighboring devices with the use of the Neighbor Discovery Protocol (NDP).

Table

For information on how to customize the appearance of the table, see [“Working with tables” on page 16](#).

Buttons

 Clear ARP table

Removes the dynamically set up addresses from the ARP table.

Port

Displays the port number.

IP address

Displays the IPv4 address or the IPv6 address of a neighboring device.

MAC address

Displays the MAC address of a neighboring device.

Last updated

Displays the time in seconds since the current settings of the entry were registered in the ARP table.

Type

Displays the type of the entry.

Possible values:

- ▶ *static*
Static entry. When the ARP table is deleted, the device keeps the static entry.
- ▶ *dynamic*
Dynamic entry. When the *Aging time [s]* has been exceeded and the device does not receive any data from this device during this time, the device deletes the dynamic entry.
- ▶ *Local*
IP and MAC address of the device management.

Active

Displays that the ARP table contains the IP/MAC address assignment as an active entry.

6.2.6 Selftest

[Diagnostics > System > Selftest]

This dialog lets you do the following:

- Activate/deactivate the RAM test when the device is being started.
- Activate/deactivate the option of changing to the system monitor during the system startup.
- Specify how the device behaves in the case of a detected error.

Configuration

If the device does not detect any readable configuration profile when restarting, then the following settings block your access to the device permanently.

- *SysMon1 is available* checkbox is *unmarked*.
- *Load default config on error* checkbox is *unmarked*.

This is the case, for example, if the password of the configuration profile that you are loading differs from the password set in the device. To have the device unlocked again, contact your sales partner.

RAM test

Activates/deactivates the RAM memory check during the system startup.

Possible values:

- ▶ *marked* (default setting)
The RAM memory check is activated. During the system startup, the device checks the RAM memory.
- ▶ *unmarked*
The RAM memory check is deactivated. This shortens the start time for the device.

SysMon1 is available

Activates/deactivates the option of changing to the system monitor during the system startup.

Possible values:

- ▶ *marked* (default setting)
The device lets you change to the system monitor during the system startup.
- ▶ *unmarked*
The device starts without the option of changing to the system monitor.

Among other things, the system monitor lets you update the device software and to delete saved configuration profiles.

Load default config on error

Activates/deactivates the loading of the default settings if the device does not detect any readable configuration profile when restarting.

Possible values:

- ▶ **marked** (default setting)
The device loads the default settings.
- ▶ **unmarked**
The device interrupts the restart and stops. The access to the device management is possible only using the Command Line Interface through the serial interface.
To regain the access to the device through the network, open the system monitor and reset the settings. After the system startup, the device uses the default settings.

Table

In this table you specify how the device behaves in the case of a detected error.

For information on how to customize the appearance of the table, see [“Working with tables” on page 16](#).

Cause

Detected error causes to which the device reacts.

Possible values:

- ▶ **task**
The device detects errors in the applications executed, for example if a task terminates or is not available.
- ▶ **resource**
The device detects errors in the resources available, for example if the memory is becoming scarce.
- ▶ **software**
The device detects software errors, for example error in the consistency check.
- ▶ **hardware**
The device detects hardware errors, for example in the chip set.

Action

Specifies how the device behaves if the adjacent event occurs.

Possible values:

- ▶ **LogOnly**
The device registers the detected error in the log file. See the [Diagnostics > Report > System Log](#) dialog.
- ▶ **sendTrap**
The device sends an SNMP trap.
The prerequisite is that in the [Diagnostics > Status Configuration > Alarms \(Traps\)](#) dialog the [Alarms \(Traps\)](#) function is enabled and at least one trap destination is specified.
- ▶ **reboot** (default setting)
The device triggers a restart.

6.3 Syslog

[Diagnostics > Syslog]

The device lets you report selected events, independent of the severity of the event, to different syslog servers.

In this dialog, you specify the settings for this function and manage up to 8 syslog servers.

Operation

Operation

Enables/disables the sending of events to the syslog servers.

Possible values:

- ▶ *On*
The sending of events is enabled.
The device sends the events specified in the table to the specified syslog servers.
- ▶ *Off* (default setting)
The sending of events is disabled.

Table

For information on how to customize the appearance of the table, see [“Working with tables” on page 16](#).

Buttons



Add

Adds a table row.



Remove

Removes the selected table row.

Index

Displays the index number to which the table row relates. The device automatically assigns the value when you add a table row.

When you delete a table row, this leaves a gap in the numbering. When you add a table row, the device fills the first gap.

Possible values:

- ▶ 1..8

IP address

Specifies the IP address of the syslog server.

Possible values:

- ▶ Valid IPv4 address (default setting: 0.0.0.0)
- ▶ Valid IPv6 address

Destination UDP port

Specifies the UDP port on which the syslog server expects the log entries.

Possible values:

- ▶ 1..65535 ($2^{16}-1$) (default setting: 514)

Transport type

Displays the transport type the device uses to send the events to the syslog server.

Possible values:

- ▶ *udp*
The device sends the events over the UDP port specified in the *Destination UDP port* column.

Min. severity

Specifies the minimum severity of the events. The device sends a log entry for events with this severity and with more urgent severities to the syslog server.

Possible values:

- ▶ *emergency*
- ▶ *alert*
- ▶ *critical*
- ▶ *error*
- ▶ *warning* (default setting)
- ▶ *notice*
- ▶ *informational*
- ▶ *debug*

Type

Specifies the type of the log entry transmitted by the device.

Possible values:

- ▶ *systemLog* (default setting)
- ▶ *audittrail*

Active

Activates/deactivates the transmission of events to the syslog server.

Possible values:

- ▶ **marked**
The device sends events to the syslog server.
- ▶ **unmarked** (default setting)
The transmission of events to the syslog server is deactivated.

6.4 Ports

[Diagnostics > Ports]

The menu contains the following dialogs:

- ▶ SFP
- ▶ TP cable diagnosis
- ▶ Port Monitor
- ▶ Auto-Disable
- ▶ Port Mirroring

6.4.1 SFP

[Diagnostics > Ports > SFP]

This dialog lets you look at the SFP transceivers currently connected to the device and their properties.

Table

The table displays valid values if the device is equipped with SFP transceivers.

For information on how to customize the appearance of the table, see [“Working with tables” on page 16](#).

Port

Displays the port number.

Module type

Type of the SFP transceiver, for example M-SFP-SX/LC.

Serial number

Displays the serial number of the SFP transceiver.

Connector type

Displays the connector type.

Supported

Displays if the device supports the SFP transceiver.

Temperature [°C]

Operating temperature of the SFP transceiver in °Celsius.

Tx power [mW]

Transmission power of the SFP transceiver in mW.

Rx power [mW]

Receiving power of the SFP transceiver in mW.

Tx power [dBm]

Transmission power of the SFP transceiver in dBm.

Rx power [dBm]

Receiving power of the SFP transceiver in dBm.

6.4.2 TP cable diagnosis

[Diagnostics > Ports > TP cable diagnosis]

This feature tests the cable attached to an interface for short or open circuit. The table displays the cable status and estimated length. The device also displays the individual cable pairs connected to the port. When the device detects a short circuit or a broken cable, it also displays the estimated distance to where it detected the problem.

To receive dependable results, use the *TP cable diagnosis* function for twisted-pair cables with a minimum length of 10 meters.

Note: This test temporarily interrupts the data stream on the port.

Information

Port

Displays the port number.

Start cable diagnosis...

Opens the *Select port* window.

From the *Port* drop-down list you select the port to be tested. Use for copper-based ports only.

To initiate the cable test on the selected port, click the *Ok* button.

Status

Status of the Virtual Cable Tester.

Possible values:

- ▶ *active*
Cable testing is in progress.
To start the test, click the *Start cable diagnosis...* button. This action opens the *Select port* window.
- ▶ *success*
The device successfully performed a test.
- ▶ *failure*
The device detected that the test was interrupted.
- ▶ *uninitialized*
The device has not performed any test yet.

Table

For information on how to customize the appearance of the table, see [“Working with tables” on page 16](#).

Cable pair

Displays the cable pair to which this table row relates. The device uses the first PHY index supported to display the values.

Result

Displays the results of the cable test.

Possible values:

- ▶ *normal*
The cable is functioning properly.
- ▶ *open*
There is a break in the cable causing an interruption.
- ▶ *short*
Wires in the cable are touching together causing a short circuit.
- ▶ *unknown*
The device displays this value for untested cable pairs.

The device displays different values than expected in the following cases:

- If no cable is connected to the port, then the device displays the value *unknown* instead of *open*.
- If the port is inactive, then the device displays the value *short*.

Min. length

Displays the minimum estimated length of the cable in meters.

If the cable length is unknown or in the *Information* frame the *Status* field displays the value *active*, *failure* or *uninitialized*, then the device displays the value 0.

Max. length

Displays the maximum estimated length of the cable in meters.

If the cable length is unknown or in the *Information* frame the *Status* field displays the value *active*, *failure* or *uninitialized*, then the device displays the value 0.

Distance [m]

Displays the estimated distance in meters from one end of the cable to the other or to an interruption in the cable.

If the cable length is unknown or in the *Information* frame the *Status* field displays the value *active*, *failure* or *uninitialized*, then the device displays the value 0.

6.4.3 Port Monitor

[Diagnostics > Ports > Port Monitor]

The *Port Monitor* function monitors the adherence to the specified parameters on the ports. If the *Port Monitor* function detects that the parameters are being exceeded, then the device performs an action.

To apply the *Port Monitor* function, perform the following steps:

- *Global* tab
 - Enable the *Port Monitor* function in the *Operation* frame.
 - Activate for each port those parameters that you want the *Port Monitor* function to monitor.
- *Link flap*, *CRC/Fragments* and *Overload detection* tabs
 - Specify the threshold values for the parameters for each port.
- *Link speed/Duplex mode detection* tab
 - Activate the allowed combinations of speed and duplex mode for each port.
- *Global* tab
 - Specify for each port an action that the device carries out if the *Port Monitor* function detects that the parameters have been exceeded.
- *Auto-disable* tab
 - Mark the *Auto-disable* checkbox for the monitored parameters if you have specified the *auto-disable* action at least once.

The dialog contains the following tabs:

- ▶ [Global]
- ▶ [Auto-disable]
- ▶ [Link flap]
- ▶ [CRC/Fragments]
- ▶ [Overload detection]
- ▶ [Link speed/Duplex mode detection]

[Global]

In this tab you enable the *Port Monitor* function and specify the parameters that the *Port Monitor* function is monitoring. Also specify the action that the device carries out if the *Port Monitor* function detects that the parameters have been exceeded.

Operation

Operation

Enables/disables the *Port Monitor* function globally.

Possible values:

- ▶ *On*
The *Port Monitor* function is enabled.
- ▶ *off* (default setting)
The *Port Monitor* function is disabled.

Table

For information on how to customize the appearance of the table, see [“Working with tables” on page 16](#).

Buttons



Reset

Opens the *Which statistic should be deleted?* window. The window displays the ports that you can enable again and reset the related counters to 0. Click and select a table row to enable the corresponding port again.

This affects the counters in the following dialogs:

- ▶ [Diagnostics > Ports > Port Monitor](#) dialog
 - [Link flap](#) tab
 - [CRC/Fragments](#) tab
 - [Overload detection](#) tab
- ▶ [Diagnostics > Ports > Auto-Disable](#) dialog

Port

Displays the port number.

Link flap on

Activates/deactivates the monitoring of link flaps on the port.

Possible values:

- ▶ [marked](#)
Monitoring is active.
 - The [Port Monitor](#) function monitors link flaps on the port.
 - If the device detects too many link flaps, then the device executes the action specified in the [Action](#) column.
 - On the [Link flap](#) tab, specify the parameters to be monitored.
- ▶ [unmarked](#) (default setting)
Monitoring is inactive.

CRC/Fragments on

Activates/deactivates the monitoring of CRC/fragment errors detected on the port.

Possible values:

- ▶ [marked](#)
Monitoring is active.
 - The [Port Monitor](#) function monitors CRC/fragment errors detected on the port.
 - If the device detects too many CRC/fragment errors, then the device executes the action specified in the [Action](#) column.
 - On the [CRC/Fragments](#) tab, specify the parameters to be monitored.
- ▶ [unmarked](#) (default setting)
Monitoring is inactive.

Duplex mismatch detection active

Activates/deactivates the monitoring of duplex mismatches on the port.

Possible values:

- ▶ **marked**
Monitoring is active.
 - The *Port Monitor* function monitors duplex mismatches on the port.
 - If the device detects a duplex mismatch, then the device executes the action specified in the *Action* column.
- ▶ **unmarked** (default setting)
Monitoring is inactive.

Overload detection on

Activates/deactivates the overload detection on the port.

Possible values:

- ▶ **marked**
Monitoring is active.
 - The *Port Monitor* function monitors the data load on the port.
 - If the device detects a data overload on the port, then the device executes the action specified in the *Action* column.
 - On the *Overload detection* tab, specify the parameters to be monitored.
- ▶ **unmarked** (default setting)
Monitoring is inactive.

Link speed/Duplex mode detection on

Activates/deactivates the monitoring of the link speed and duplex mode on the port.

Possible values:

- ▶ **marked**
Monitoring is active.
 - The *Port Monitor* function monitors the link speed and duplex mode on the port.
 - If the device detects an unpermitted combination of link speed and duplex mode, then the device executes the action specified in the *Action* column.
 - On the *Link speed/Duplex mode detection* tab, specify the parameters to be monitored.
- ▶ **unmarked** (default setting)
Monitoring is inactive.

Active condition

Displays the monitored parameter that led to the action on the port.

Possible values:

- ▶ **-**
No monitored parameter.
The device does not carry out any action.
- ▶ **Link flap**
Too many link changes during the observed period.
- ▶ **CRC/Fragments**
Too many CRC/fragment errors detected during the observed period.
- ▶ **Duplex mismatch**
Duplex mismatch detected.

- ▶ *OverLoad detection*
Overload detected during the observed period.
- ▶ *Link speed/Duplex mode detection*
Impermissible combination of speed and duplex mode detected.

Action

Specifies the action that the device carries out if the *Port Monitor* function detects that the parameters have been exceeded.

Possible values:

- ▶ *disable port*
The device disables the port and sends an SNMP trap.
The Link status LED for the port flashes 3 × per period.
 - To re-enable the port, select the table row of the port, click the  button.
 - If the parameters are no longer being exceeded, then the *Auto-Disable* function enables the relevant port again after the specified waiting period. The prerequisite is that on the *Auto-disable* tab the checkbox for the monitored parameter is marked.
- ▶ *send trap*
The device sends an SNMP trap.
The prerequisite is that in the *Diagnostics > Status Configuration > Alarms (Traps)* dialog the *Alarms (Traps)* function is enabled and at least one trap destination is specified.
- ▶ *auto-disable* (default setting)
The device disables the port and sends an SNMP trap.
The Link status LED for the port flashes 3 × per period.
The prerequisite is that on the *Auto-disable* tab the checkbox for the monitored parameter is marked.
 - The *Diagnostics > Ports > Auto-Disable* dialog displays which ports are currently disabled due to the parameters being exceeded.
 - After a waiting period, the *Auto-Disable* function enables the port again automatically. For this you go to the *Diagnostics > Ports > Auto-Disable* dialog and specify a waiting period for the relevant port in the *Reset timer [s]* column.

Port status

Displays the operating state of the port.

Possible values:

- ▶ *up*
The port is enabled.
- ▶ *down*
The port is disabled.
- ▶ *notPresent*
Physical port unavailable.

[Auto-disable]

In this tab you activate the *Auto-Disable* function for the parameters monitored by the *Port Monitor* function.

Table

For information on how to customize the appearance of the table, see [“Working with tables” on page 16](#).

Reason

Displays the parameters monitored by the *Port Monitor* function.

Mark the adjacent checkbox so that the *Port Monitor* function carries out the *auto-disable* action if it detects that the monitored parameters have been exceeded.

Auto-disable

Activates/deactivates the *Auto-Disable* function for the adjacent parameters.

Possible values:

- ▶ *marked*
The *Auto-Disable* function for the adjacent parameters is active.
If the adjacent parameters are exceeded and the value *auto-disable* is specified in the *Action* column, then the device carries out the *Auto-Disable* function.
- ▶ *unmarked* (default setting)
The *Auto-Disable* function for the adjacent parameters is inactive.

[Link flap]

In this tab you specify individually for every port the following settings:

- The number of link changes.
- The period during which the *Port Monitor* function monitors a parameter to detect discrepancies.

You also see how many link changes the *Port Monitor* function has detected up to now.

The *Port Monitor* function monitors those ports for which the checkbox in the *Link flap on* column is marked on the *Global* tab.

Table

For information on how to customize the appearance of the table, see [“Working with tables” on page 16](#).

Port

Displays the port number.

Sampling interval [s]

Specifies in seconds, the period during which the *Port Monitor* function monitors a parameter to detect discrepancies.

Possible values:

▶ 1..180 (default setting: 10)

Link flaps

Specifies the number of link changes.

If the *Port Monitor* function detects this number of link changes in the monitored period, then the device performs the specified action.

Possible values:

▶ 1..100 (default setting: 5)

Last sampling interval

Displays the number of errors that the device has detected during the period that has elapsed.

Total

Displays the total number of errors that the device has detected since the port was enabled.

[CRC/Fragments]

In this tab you specify individually for every port the following settings:

- The detected fragment error rate.
- The period during which the *Port Monitor* function monitors a parameter to detect discrepancies.

You also see the fragment error rate that the device has detected up to now.

The *Port Monitor* function monitors those ports for which the checkbox in the *CRC/Fragments on* column is marked on the *Global* tab.

Table

For information on how to customize the appearance of the table, see [“Working with tables” on page 16](#).

Port

Displays the port number.

Sampling interval [s]

Specifies in seconds, the period during which the *Port Monitor* function monitors a parameter to detect discrepancies.

Possible values:

▶ 5..180 (default setting: 10)

CRC/Fragments count [ppm]

Specifies the detected fragment error rate (in parts per million).

If the *Port Monitor* function detects this fragment error rate in the monitored period, then the device performs the specified action.

Possible values:

▶ 1..1000000 (10^6) (default setting: 1000)

Last active interval [ppm]

Displays the fragment error rate that the device has detected during the period that has elapsed.

Total [ppm]

Displays the fragment error rate that the device has detected since the port was enabled.

[Overload detection]

In this tab you specify individually for every port the following settings:

- The load threshold values.
- The period during which the *Port Monitor* function monitors a parameter to detect discrepancies.

You also see the number of data packets that the device has detected up to now.

The *Port Monitor* function monitors those ports for which the checkbox in the *Overload detection on* column is marked on the *Global* tab.

The *Port Monitor* function does not monitor any ports that are members of a link aggregation group.

Table

For information on how to customize the appearance of the table, see [“Working with tables” on page 16](#).

Port

Displays the port number.

Type

Specifies the type of data packets that the device takes into account when monitoring the load on the port.

Possible values:

- ▶ *all*
The *Port Monitor* function monitors Broadcast, Multicast and Unicast packets.
- ▶ *bc* (default setting)
The *Port Monitor* function monitors only Broadcast packets.
- ▶ *bc-mc*
The *Port Monitor* function monitors only Broadcast and Multicast packets.

Unit

Specifies the unit for the data rate.

Possible values:

- ▶ *pps* (default setting)
packets per second
- ▶ *kbps*
kbit per second
The prerequisite is that in the *Type* column the value *all* is specified.

Lower threshold

Specifies the lower threshold value for the data rate.

The *Auto-Disable* function enables the port again only when the load on the port is lower than the value specified here.

Possible values:

- ▶ *0..10000000 (10⁷)* (default setting: 0)

Upper threshold

Specifies the upper threshold value for the data rate.

If the *Port Monitor* function detects this load in the monitored period, then the device performs the specified action.

Possible values:

- ▶ *0..10000000 (10⁷)* (default setting: 0))

Interval [s]

Specifies in seconds, the period that the *Port Monitor* function observes a parameter to detect that a parameter is being exceeded.

Possible values:

- ▶ *1..20* (default setting: 1)

Packets

Displays the number of Broadcast, Multicast and Unicast packets that the device has detected during the period that has elapsed.

Broadcast packets

Displays the number of Broadcast packets that the device has detected during the period that has elapsed.

Multicast packets

Displays the number of Multicast packets that the device has detected during the period that has elapsed.

kbit/s

Displays the data rate in Kbits per second that the device has detected during the period that has elapsed.

[Link speed/Duplex mode detection]

In this tab you activate the allowed combinations of speed and duplex mode for each port.

The *Port Monitor* function monitors those ports for which the checkbox in the *Link speed/Duplex mode detection on* column is marked on the *Global* tab.

The *Port Monitor* function monitors only enabled physical ports.

Table

For information on how to customize the appearance of the table, see “[Working with tables](#)” on [page 16](#).

Port

Displays the port number.

10M HDX

Activates/deactivates the port monitor to accept a half-duplex and 10 Mbit/s data rate combination on the port.

Possible values:

▶ **marked**

The port monitor takes into consideration the speed and duplex combination.

▶ **unmarked**

If the port monitor detects the speed and duplex combination on the port, then the device executes the action specified in the *Global* tab.

10M FDX

Activates/deactivates the port monitor to accept a full-duplex and 10 Mbit/s data rate combination on the port.

Possible values:

- ▶ [marked](#)
The port monitor takes into consideration the speed and duplex combination.
- ▶ [unmarked](#)
If the port monitor detects the speed and duplex combination on the port, then the device executes the action specified in the [Global](#) tab.

100M HDX

Activates/deactivates the port monitor to accept a half-duplex and 100 Mbit/s data rate combination on the port.

Possible values:

- ▶ [marked](#)
The port monitor takes into consideration the speed and duplex combination.
- ▶ [unmarked](#)
If the port monitor detects the speed and duplex combination on the port, then the device executes the action specified in the [Global](#) tab.

100M FDX

Activates/deactivates the port monitor to accept a full-duplex and 100 Mbit/s data rate combination on the port.

Possible values:

- ▶ [marked](#)
The port monitor takes into consideration the speed and duplex combination.
- ▶ [unmarked](#)
If the port monitor detects the speed and duplex combination on the port, then the device executes the action specified in the [Global](#) tab.

1G FDX

Activates/deactivates the port monitor to accept a full-duplex and 1 Gbit/s data rate combination on the port.

Possible values:

- ▶ [marked](#)
The port monitor takes into consideration the speed and duplex combination.
- ▶ [unmarked](#)
If the port monitor detects the speed and duplex combination on the port, then the device executes the action specified in the [Global](#) tab.

2.5G FDX

Activates/deactivates the port monitor to accept a full-duplex and 2.5 Gbit/s data rate combination on the port.

Possible values:

- ▶ [marked](#)
The port monitor takes into consideration the speed and duplex combination.
- ▶ [unmarked](#)
If the port monitor detects the speed and duplex combination on the port, then the device executes the action specified in the [Global](#) tab.

10G

Activates/deactivates the port monitor to accept a full-duplex and 10 Gbit/s data rate combination on the port.

Possible values:

- ▶ [marked](#)
The port monitor takes into consideration the speed and duplex combination.
- ▶ [unmarked](#)
If the port monitor detects the speed and duplex combination on the port, then the device executes the action specified in the [Global](#) tab.

6.4.4 Auto-Disable

[Diagnostics > Ports > Auto-Disable]

The *Auto-Disable* function lets you disable monitored ports automatically and enable them again as you desire.

For example, the *Port Monitor* function and selected functions in the *Network Security* menu use the *Auto-Disable* function to disable ports if monitored parameters are exceeded.

If the parameters are no longer being exceeded, then the *Auto-Disable* function enables the relevant port again after the specified waiting period.

The dialog contains the following tabs:

- ▶ [Port]
- ▶ [Status]

[Port]

This tab displays which ports are currently disabled due to the parameters being exceeded. If the parameters are no longer being exceeded and you specify a waiting period in the *Reset timer [s]* column, then the *Auto-Disable* function automatically enables the relevant port again.

Table

For information on how to customize the appearance of the table, see “Working with tables” on page 16.

Buttons



Opens the *Which statistic should be deleted?* window. The window displays the ports that you can enable again and reset the related counters to 0. Click and select a table row to enable the corresponding port again.

This affects the counters in the following dialogs:

- ▶ *Diagnostics > Ports > Auto-Disable* dialog
- ▶ *Diagnostics > Ports > Port Monitor* dialog
 - *Link flap* tab
 - *CRC/Fragments* tab
 - *Overload detection* tab

Port

Displays the port number.

Reset timer [s]

Specifies the waiting period in seconds, after which the *Auto-Disable* function enables the port again.

Possible values:

- ▶ 0 (default setting)
The timer is inactive. The port remains disabled.
- ▶ 30..4294967295 ($2^{32}-1$)
If the parameters are no longer being exceeded, then the *Auto-Disable* function enables the port again after the waiting period specified here.

Error time

Displays when the device disabled the port due to the parameters being exceeded.

Remaining time [s]

Displays the remaining time in seconds, until the *Auto-Disable* function enables the port again.

Component

Displays the software component in the device that disabled the port.

Possible values:

- ▶ PORT_MON
Port Monitor
See the *Diagnostics > Ports > Port Monitor* dialog.
- ▶ PORT_ML
Port Security
See the *Network Security > Port Security* dialog.
- ▶ DOT1S
BPDU guard
See the *Switching > L2-Redundancy > Spanning Tree > Global* dialog.

Reason

Displays the monitored parameter that led to the port being disabled.

Possible values:

- ▶ none
No monitored parameter.
The port is enabled.
- ▶ *Link flap*
Too many link changes. See the *Diagnostics > Ports > Port Monitor* dialog, *Link flap* tab.
- ▶ *CRC error*
Too many CRC/fragment errors are detected. See the *Diagnostics > Ports > Port Monitor* dialog, *CRC/Fragments* tab.
- ▶ *Duplex mismatch*
Duplex mismatch detected. See the *Diagnostics > Ports > Port Monitor* dialog, *Global* tab.
- ▶ *BPDU rate*
STP-BPDUs received. See the *Switching > L2-Redundancy > Spanning Tree > Global* dialog.
- ▶ *MAC-based port security*
Too many data packets from undesired senders. See the *Network Security > Port Security* dialog.

- ▶ *OverLoad detection*
Overload. See the *Diagnostics > Ports > Port Monitor* dialog, *Overload detection* tab.
- ▶ *Speed duplex*
Impermissible combination of speed and duplex mode detected. See the *Diagnostics > Ports > Port Monitor* dialog, *Link speed/Duplex mode detection* tab.

Active

Displays if the port is currently disabled due to the parameters being exceeded.

Possible values:

- ▶ *marked*
The port is currently disabled.
- ▶ *unmarked*
The port is enabled.

[Status]

This tab displays the monitored parameters for which the *Auto-Disable* function is active.

Table

For information on how to customize the appearance of the table, see “Working with tables” on page 16.

Reason

Displays the parameters that the device monitors.

Mark the adjacent checkbox so that the *Auto-Disable* function disables and, when applicable, enables the port again if the monitored parameters are exceeded.

Category

Displays which function the adjacent parameter belongs to.

Possible values:

- ▶ *port monitor*
The parameter belongs to the functions in the *Diagnostics > Ports > Port Monitor* dialog.
- ▶ *network security*
The parameter belongs to the functions in the *Network Security* dialog.
- ▶ *L2 redundancy*
The parameter belongs to the functions in the *Switching > L2-Redundancy* dialog.

Auto-disable

Displays if the *Auto-Disable* function is active/inactive for the adjacent parameter.

Possible values:

- ▶ **marked**
The *Auto-Disable* function for the adjacent parameters is active.
The *Auto-Disable* function disables and, when applicable, enables the relevant port again if the monitored parameters are exceeded.
- ▶ **unmarked** (default setting)
The *Auto-Disable* function for the adjacent parameters is inactive.

6.4.5 Port Mirroring

[Diagnostics > Ports > Port Mirroring]

The *Port Mirroring* function lets you copy received and sent data packets from selected ports to a destination port. You can watch and process the data stream using an analyzer or an *RMON probe*, connected to the destination port. The data packets remain unmodified on the source port.

Note: To enable the access to the device management using the destination port, mark the checkbox *Allow management* in the *Destination port* frame before you enable the *Port Mirroring* function.

Operation

Buttons



Resets the settings in the dialog to the default settings and restores the previously applied settings.

Operation

Enables/disables the *Port Mirroring* function.

Possible values:

- ▶ *On*
The *Port Mirroring* function is enabled.
The device copies the data packets from the selected source ports to the destination port.
- ▶ *Off* (default setting)
The *Port Mirroring* function is disabled.

Destination port

Primary port

Specifies the destination port.

Suitable ports are those ports that are not used for the following purposes:

- Source port
- Uplink port on which a Layer 2 redundancy protocol is active

Possible values:

- ▶ - (default setting)
No destination port selected.
- ▶ <Port number>
Number of the destination port. The device copies the data packets from the source ports to this port.

On the destination port, the device adds a VLAN tag to the data packets that the source port sends. The destination port sends the unmodified data packets that the source port receives.

Note: The destination port needs sufficient bandwidth to absorb the data stream. If the copied data stream exceeds the bandwidth of the destination port, then the device discards superfluous data packets on the destination port.

Allow management

Activates/deactivates the access to the device management using the destination port.

Possible values:

- ▶ **marked**
 - The access to the device management using the destination port is active.
 - The device lets users have access to the device management using the destination port without interrupting the active *Port Mirroring* session.
 - The device duplicates multicasts, broadcasts and unknown unicasts on the destination port.
 - The VLAN settings on the destination port remain unchanged. The prerequisite for access to the device management using the destination port is that the destination port is not a member of the VLAN of the device management.
- ▶ **unmarked** (default setting)
 - The access to the device management using the destination port is inactive.
 - The device prohibits the access to the device management using the destination port.

Table

For information on how to customize the appearance of the table, see [“Working with tables” on page 16](#).

Source port

Displays the port number.

Enabled

Activates/deactivates the copying of the data packets from this source port to the destination port.

Possible values:

- ▶ **marked**
 - The copying of the data packets is active.
 - The port is specified as a source port.
- ▶ **unmarked** (default setting)
 - The copying of the data packets is inactive.
- ▶ (Grayed-out display)
 - It is not possible to copy the data packets for this port.
 - Possible causes:
 - The port is already specified as a destination port.
 - The port is a logical port, not a physical port.

Note: The device lets you activate every physical port as source port except for the destination port.

Type

Specifies which data packets the device copies to the destination port.

On the destination port, the device adds a VLAN tag to the data packets that the source port sends. The destination port sends the unmodified data packets that the source port receives.

Possible values:

- ▶ *none* (default setting)
No data packets.
- ▶ *tx*
Data packets that the source port sends.
- ▶ *rx*
Data packets that the source port receives.
- ▶ *txrx*
Data packets that the source port sends.

Note: With the *txrx* setting the device copies each transmitted data packet. The destination ports needs at least a bandwidth that corresponds to the sum of the send and receive channel of the source ports. For example, for similar ports the destination port is at 100 % capacity when the send and receive channel of a source port are at 50 % capacity respectively.

6.5 LLDP

[Diagnostics > LLDP]

The device lets you gather information about neighboring devices. For this, the device uses the Link Layer Discovery Protocol (LLDP). This information lets a network management station map the structure of the network.

This menu lets you set up the topology discovery and to display the information received in tabular form.

The menu contains the following dialogs:

- ▶ [LLDP Configuration](#)
- ▶ [LLDP Topology Discovery](#)

6.5.1 LLDP Configuration

[Diagnostics > LLDP > Configuration]

This dialog lets you set up the topology discovery for every port.

Operation

Operation

Enables/disables the *LLDP* function.

Possible values:

- ▶ *On* (default setting)
The *LLDP* function is enabled.
The topology discovery using LLDP is active in the device.
- ▶ *Off*
The *LLDP* function is disabled.

Configuration

Transmit interval [s]

Specifies the interval in seconds at which the device sends LLDP data packets.

Possible values:

- ▶ *5..32768* (2^{15}) (default setting: *30*)

Transmit interval multiplier

Specifies the factor for determining the time-to-live value for the LLDP data packets.

Possible values:

- ▶ *2..10* (default setting: *4*)

The time-to-live value coded in the LLDP header results from multiplying this value with the value in the *Transmit interval [s]* field.

Reinit delay [s]

Specifies the delay in seconds for the reinitialization of a port.

Possible values:

- ▶ *1..10* (default setting: *2*)

If in the *Operation* column the value *Off* is specified, then the device tries to reinitialize the port after the time specified here has elapsed.

Transmit delay [s]

Specifies the delay in seconds for transmitting successive LLDP data packets after the device settings change.

Possible values:

- ▶ [1..8192](#) (default setting: 2)

The recommended value is between a minimum of 1 and a maximum of a quarter of the value in the [Transmit interval \[s\]](#) field.

Notification interval [s]

Specifies the interval in seconds for transmitting LLDP notifications.

Possible values:

- ▶ [5..3600](#) (default setting: 5)

After transmitting a notification trap, the device waits for a minimum of the time specified here before transmitting the next notification trap.

Table

For information on how to customize the appearance of the table, see [“Working with tables” on page 16](#).

Port

Displays the port number.

Operation

Specifies if the port transmits LLDP data packets.

Possible values:

- ▶ [transmit](#)
The port sends LLDP data packets but does not save any information about neighboring devices.
- ▶ [receive](#)
The port receives LLDP data packets but does not send any information to neighboring devices.
- ▶ [receive and transmit](#) (default setting)
The port transmits LLDP data packets and saves information about neighboring devices.
- ▶ [disabled](#)
The port does not send LLDP data packets and does not save information about neighboring devices.

Notification

Activates/deactivates the LLDP notifications on the port.

Possible values:

- ▶ **marked**
LLDP notifications are active on the port.
- ▶ **unmarked** (default setting)
LLDP notifications are inactive on the port.

Transmit port description

Activates/deactivates the transmitting of a TLV (Type Length Value) with the port description.

Possible values:

- ▶ **marked** (default setting)
The transmitting of the TLV is active.
The device sends the TLV with the port description.
- ▶ **unmarked**
The transmitting of the TLV is inactive.
The device does not send a TLV with the port description.

Transmit system name

Activates/deactivates the transmitting of a TLV (Type Length Value) with the device name.

Possible values:

- ▶ **marked** (default setting)
The transmitting of the TLV is active.
The device sends the TLV with the device name.
- ▶ **unmarked**
The transmitting of the TLV is inactive.
The device does not send a TLV with the device name.

Transmit system description

Activates/deactivates the transmitting of the TLV (Type Length Value) with the system description.

Possible values:

- ▶ **marked** (default setting)
The transmitting of the TLV is active.
The device sends the TLV with the system description.
- ▶ **unmarked**
The transmitting of the TLV is inactive.
The device does not send a TLV with the system description.

Transmit system capabilities

Activates/deactivates the transmitting of the TLV (Type Length Value) with the system capabilities.

Possible values:

- ▶ *marked* (default setting)
The transmitting of the TLV is active.
The device sends the TLV with the system capabilities.
- ▶ *unmarked*
The transmitting of the TLV is inactive.
The device does not send a TLV with the system capabilities.

Neighbors (max.)

Limits the number of neighboring devices to be recorded for this port.

Possible values:

- ▶ *1..50* (default setting: *10*)

FDB mode

Specifies which function the device uses to record neighboring devices on this port.

Possible values:

- ▶ *LldpOnly*
The device uses only LLDP data packets to record neighboring devices on this port.
- ▶ *macOnly*
The device uses learned MAC addresses to record neighboring devices on this port. The device uses the MAC address only if there is no other entry in the MAC address table (forwarding database) for this port.
- ▶ *both*
The device uses LLDP data packets and learned MAC addresses to record neighboring devices on this port.
- ▶ *autoDetect* (default setting)
If the device receives LLDP data packets at this port, then the device operates the same as with the *LldpOnly* setting. Otherwise, the device operates the same as with the *macOnly* setting.

6.5.2 LLDP Topology Discovery

[Diagnostics > LLDP > Topology Discovery]

Devices in networks send notifications in the form of packets which are also known as "LLDPDU" (LLDP data units). The data that is sent and received through LLDPDUs is useful for many reasons. Thus the device detects which devices in the network are neighbors and through which ports they are connected.

The dialog lets you display the network and to detect the connected devices along with their specific features.

The dialog contains the following tabs:

- ▶ [LLDP]
- ▶ [LLDP-MED]

[LLDP]

This tab displays the collected LLDP information for the neighboring devices. This information lets a network management station map the structure of the network.

When devices both with and without an active topology discovery function are connected to a port, the topology table hides the devices without active topology discovery.

When only devices without active topology discovery are connected to a port, the table contains one line for this port to represent every device. This line contains the number of connected devices.

The MAC address table (forwarding database) contains MAC addresses of devices that the topology table hides for the sake of clarity.

When you use one port to connect several devices, for example through a hub, the table shows one line for each connected device.

Table

For information on how to customize the appearance of the table, see ["Working with tables" on page 16](#).

Port

Displays the port number.

Neighbor identifier

Displays the chassis ID of the neighboring device. This can be the basis MAC address of the neighboring device, for example.

FDB

Displays if the connected device has active LLDP support.

Possible values:

- ▶ **marked**
The connected device does not have active LLDP support.
The device uses information from its MAC address table (forwarding database)
- ▶ **unmarked**
The connected device has active LLDP support.

Neighbor address

Displays the IPv4 address or hostname with which the access to the neighboring device management is possible.

Neighbor IPv6 address

Displays the IPv6 address with which the access to the neighboring device management is possible.

Neighbor port description

Displays a description for the port of the neighboring device.

Neighbor system name

Displays the device name of the neighboring device.

Neighbor system description

Displays a description for the neighboring device.

Port ID

Displays the ID of the port through which the neighboring device is connected to the device.

Autonegotiation supported

Displays if the port of the neighboring device supports auto-negotiation.

Autonegotiation

Displays if auto-negotiation is active on the port of the neighboring device.

PoE supported

Displays if the port of the neighboring device supports Power over Ethernet (PoE).

PoE enabled

Displays if Power over Ethernet (PoE) is active on the port of the neighboring device.

[LLDP-MED]

LLDP for Media Endpoint Devices (LLDP-MED) is an extension to LLDP that operates between endpoint devices and network devices. It specifically provides support for VoIP applications. In this support rule, it provides an additional set of common advertisement, Type Length Value (TLV), messages. The device uses the TLVs for capabilities discovery such as network policy, Power over Ethernet, inventory management and location information.

Table

For information on how to customize the appearance of the table, see [“Working with tables” on page 16](#).

Port

Displays the port number.

Device class

Displays the device class of the remotely connected device.

Possible values:

- ▶ *notDefined*
The device has capabilities not covered by any of the *LLDP-MED* classes.
- ▶ *endpointClass1*
The device has *endpointClass1* capabilities.
- ▶ *endpointClass2*
The device has *endpointClass2* capabilities.
- ▶ *endpointClass3*
The device has *endpointClass3* capabilities.
- ▶ *networkConnectivity*
The device has network connectivity device capabilities.

VLAN ID

Displays the extension of the VLAN Identifier for the remote system connected to this port, as defined in IEEE 802.3.

- ▶ 0
Priority tagged packets
Only the 802.1D priority is significant and the device uses the default VLAN ID of the ingress port.
- ▶ 1..4042
Valid Port VLAN ID

Priority

Displays the value of the *802.1D Priority* which is associated with the remote system connected to the port.

DSCP

Displays the value of the *Differentiated Service Code Point (DSCP)* which is associated with the remote system connected to the port.

Unknown bit status

Displays the *Unknown Bit Status* of incoming data packets.

Possible values:

- ▶ *true*
The network policy for the specified application type is currently unknown. In this case, the device ignores the Layer 2 priority and value of the *DSCP* field.
- ▶ *false*
Indicates a specified network policy.

Tagged bit status

Displays the tagged bit status.

Possible values:

- ▶ *true*
The application uses a tagged VLAN.
- ▶ *false*
For the specific application the device uses untagged VLAN operation. In this case, the device ignores both the VLAN ID and the Layer 2 priority fields. The DSCP value on Layer 3, however, is relevant.

Hardware revision

Displays the vendor-specific hardware revision string as advertised by the remote endpoint.

Firmware revision

Displays the vendor-specific firmware revision string as advertised by the remote endpoint.

Software revision

Displays the vendor-specific software revision string as advertised by the remote endpoint.

Serial number

Displays the vendor-specific serial number as advertised by the remote endpoint.

Manufacturer name

Displays the vendor-specific manufacturer name as advertised by the remote endpoint.

Model name

Displays the vendor-specific model name as advertised by the remote endpoint.

Asset ID

Displays the vendor-specific asset tracking identifier as advertised by the remote endpoint.

6.6 Report

[Diagnostics > Report]

The menu contains the following dialogs:

- ▶ [Report Global](#)
- ▶ [Persistent Logging](#)
- ▶ [System Log](#)
- ▶ [Audit Trail](#)

6.6.1 Report Global

[Diagnostics > Report > Global]

The device lets you log specific events using the following outputs:

- on the console
- on one or more syslog servers
- on a connection to the Command Line Interface set up using SSH
- on a connection to the Command Line Interface set up using Telnet

In this dialog, you specify the required settings. By assigning the severity you specify which events the device registers.

The dialog lets you save a ZIP archive with detailed device information for support purposes on your PC.

Console logging

Buttons

 Download support information

Generates a ZIP archive which the web browser lets you download from the device.

The ZIP archive contains files with detailed device information for support purposes. For further information, see [“Support Information: Files in ZIP archive” on page 346](#).

Operation

Enables/disables the *Console logging* function.

Possible values:

- ▶ *On*
The *Console logging* function is enabled.
The device logs the events on the console.
- ▶ *Off* (default setting)
The *Console logging* function is disabled.

Severity

Specifies the minimum severity for the events. The device logs events with this severity and with more urgent severities. For further information, see [“Meaning of the event severities” on page 346](#).

The device outputs the messages on the serial interface.

Possible values:

- ▶ *emergency*
- ▶ *alert*
- ▶ *critical*
- ▶ *error*
- ▶ *warning* (default setting)
- ▶ *notice*

- ▶ *informational*
- ▶ *debug*

SNMP logging

When you enable the logging of SNMP requests, the device sends these as events with the preset severity *notice* to the list of syslog servers. The preset minimum severity for a syslog server entry is *critical*.

To send SNMP requests to a syslog server, you have a number of options to change the default settings. Select the ones that meet your requirements best.

- Set the severity for which the device generates SNMP requests as events to *warning* or *error*. Change the minimum severity for a syslog entry for one or more syslog servers to the same value.
You also have the option of adding a separate syslog server entry for this.
- Set only the severity for SNMP requests to *critical* or higher. The device then sends SNMP requests as events with the severity *critical* or higher to the syslog servers.
- Set only the minimum severity for one or more syslog server entries to *notice* or lower. Then it is possible that the device sends many events to the syslog servers.

Log SNMP get request

Enables/disables the logging for the reception of *SNMP Get requests*.

Possible values:

- ▶ *On*
The logging is enabled.
The device logs each received *SNMP Get request* as an event in the syslog.
From the *Severity get request* drop-down list, you select the severity for this event.
- ▶ *Off* (default setting)
The logging is disabled.

Log SNMP set request

Enables/disables the logging for the reception of *SNMP Set requests*.

Possible values:

- ▶ *On*
The logging is enabled.
The device logs each received *SNMP Set request* as an event in the syslog.
From the *Severity set request* drop-down list, you select the severity for this event.
- ▶ *Off* (default setting)
The logging is disabled.

Severity get request

Specifies the severity of the event that the device logs for received *SNMP Get requests*. For further information, see “[Meaning of the event severities](#)” on page 346.

Possible values:

- ▶ *emergency*
- ▶ *alert*
- ▶ *critical*

- ▶ *error*
- ▶ *warning*
- ▶ *notice* (default setting)
- ▶ *informational*
- ▶ *debug*

Severity set request

Specifies the severity of the event that the device logs for received *SNMP Set requests*. For further information, see [“Meaning of the event severities” on page 346](#).

Possible values:

- ▶ *emergency*
- ▶ *alert*
- ▶ *critical*
- ▶ *error*
- ▶ *warning*
- ▶ *notice* (default setting)
- ▶ *informational*
- ▶ *debug*

Buffered logging

The device buffers logged events in 2 separate storage areas so that the log entries for urgent events are kept.

This dialog lets you specify the minimum severity for events that the device buffers in the storage area with a higher priority.

Severity

Specifies the minimum severity for the events. The device buffers log entries for events with this severity and with more urgent severities in the storage area with a higher priority. For further information, see [“Meaning of the event severities” on page 346](#).

Possible values:

- ▶ *emergency*
- ▶ *alert*
- ▶ *critical*
- ▶ *error*
- ▶ *warning* (default setting)
- ▶ *notice*
- ▶ *informational*
- ▶ *debug*

CLI logging

Operation

Enables/disables the *CLI logging* function.

Possible values:

- ▶ *On*
The *CLI logging* function is enabled.
The device logs every command received using the Command Line Interface.
- ▶ *Off* (default setting)
The *CLI logging* function is disabled.

Support Information: Files in ZIP archive

File name	Format	Comments
audittrail.html	HTML	Contains the chronological recording of the system events and saved user changes in the <i>Audit Trail</i> protocol.
config.xml	XML	Contains the settings of the device saved in the "Selected" configuration profile.
defaultconfig.xml	XML	Contains the default settings of the device.
script	TEXT	Contains the output of the command <code>show running-config script</code> .
runningconfig.xml	XML	Contains the current operating settings of the device.
supportinfo.html	HTML	Contains device internal service information.
systeminfo.html	HTML	Contains information about the current settings and operating parameters.
systemlog.html	HTML	Contains the logged events in the Log file. See the Diagnostics > Report > System Log dialog.

Meaning of the event severities

Severity	Meaning
<i>emergency</i>	Device not ready for operation
<i>alert</i>	Immediate user intervention required
<i>critical</i>	Critical status
<i>error</i>	Error status
<i>warning</i>	Warning
<i>notice</i>	Significant, normal status
<i>informational</i>	Information message
<i>debug</i>	Debug message

6.6.2 Persistent Logging

[Diagnostics > Report > Persistent Logging]

The device lets you save log entries permanently in a file in the external memory. Therefore, even after the device is restarted you have access to the log entries.

In this dialog, you limit the size of the log file and specify the minimum severity for the events to be saved. When the log file reaches the specified size, the device archives this file and saves the following log entries in a newly generated file.

In the table the device displays you the log files held in the external memory. As soon as the specified maximum number of files has been attained, the device deletes the oldest file and renames the remaining files. This helps ensure that there is enough memory space in the external memory.

Note: Verify that an external memory is connected. To verify if an external memory is connected, see the *Status* column in the *Basic Settings > External Memory* dialog. We recommend to monitor the external memory connection using the *Device Status* function, see the *External memory removal* parameter in the *Diagnostics > Status Configuration > Device Status* dialog.

Operation

Operation

Enables/disables the *Persistent Logging* function.

Only activate this function if the external memory is available in the device.

Possible values:

- ▶ *On* (default setting)
The *Persistent Logging* function is enabled.
The device saves the log entries in a file in the external memory.
- ▶ *Off*
The *Persistent Logging* function is disabled.

Configuration

Max. file size [kbyte]

Specifies the maximum size of the log file in KBytes. When the log file reaches the specified size, the device archives this file and saves the following log entries in a newly generated file.

Possible values:

- ▶ *0..4096* (default setting: *1024*)

The value *0* deactivates saving of log entries in the log file.

Files (max.)

Specifies the number of log files that the device keeps in the external memory.

As soon as the specified maximum number of files has been attained, the device deletes the oldest file and renames the remaining files.

Possible values:

- ▶ 0..25 (default setting: 4)

The value 0 deactivates saving of log entries in the log file.

Severity

Specifies the minimum severity of the events. The device saves the log entry for events with this severity and with more urgent severities in the log file in the external memory.

Possible values:

- ▶ *emergency*
- ▶ *alert*
- ▶ *critical*
- ▶ *error*
- ▶ *warning* (default setting)
- ▶ *notice*
- ▶ *informational*
- ▶ *debug*

Log file target

Specifies the external memory device for logging.

Possible values:

- ▶ *sd* (default setting)
External SD memory (ACA31)

Table

For information on how to customize the appearance of the table, see [“Working with tables” on page 16](#).

Buttons



Clear persistent log file

Removes the log files from the external memory.

Index

Displays the index number to which the table row relates.

Possible values:

▶ 1..25

The device automatically assigns this number.

File name

Displays the file name of the log file in the external memory.

Possible values:

▶ messages

▶ messages.X

File size [byte]

Displays the size of the log file in the external memory in bytes.

6.6.3 System Log

[Diagnostics > Report > System Log]

This dialog displays the System Log file. The device logs device-internal events in the System Log file. The device keeps the logged events even after a restart.

To search the System Log file, use the search function of your web browser.

The dialog lets you download a copy of the System Log file onto your computer. The device provides the file to be downloaded in HTML format.

Buttons



Save log file

Downloads a copy of the System Log file onto your computer, based on the web browser settings.



Clear log file

Clears the System Log file on the device.

6.6.4 Audit Trail

[Diagnostics > Report > Audit Trail]

This dialog displays the Audit Trail. The dialog lets you save the log file as an HTML file on your PC.

To search the log file for search terms, use the search function of your web browser.

The device logs system events and writing user actions in the device. This lets you keep track of WHO changes WHAT in the device and WHEN. The prerequisite is that the access role [auditor](#) or [administrator](#) is assigned to your user account.

The device logs the following user actions, among others:

- A user logging into the device management with the Command Line Interface (local or remote)
- A user logging off manually
- Automatic logging off of a user in the Command Line Interface after a specified period of inactivity
- Device restart
- Locking of a user account due to too many consecutive unsuccessful login attempts
- Locking of the access to the device management due to unsuccessful login attempts
- Commands executed in the Command Line Interface, apart from `show` commands
- Changes to configuration variables
- Changes to the system time
- File transfer operations, including device software updates
- Configuration changes using HiDiscovery
- Device software updates and automatic configuration of the device through the external memory
- Opening and closing of SNMP through an HTTPS tunnel

The device does not log passwords. The logged entries are write-protected and remain saved in the device after a restart.

Note: During the system startup, access to the system monitor is possible using the default settings of the device. If an attacker gains physical access to the device, then he is able to reset the device settings to its default values using the system monitor. After this, the device and log file are accessible using the standard password. Take appropriate measures to restrict physical access to the device. Otherwise, deactivate access to the system monitor. See the [Diagnostics > System > Selftest](#) dialog, [SysMon1 is available](#) checkbox.

Buttons



Save audit trail file

Saves the HTML page on your PC using the web browser dialog.

7 Advanced

The menu contains the following dialogs:

- ▶ [DHCP](#)
- ▶ [Industrial Protocols](#)
- ▶ [Command Line Interface](#)

7.1 DHCP

[Advanced > DHCP]

The menu contains the following dialogs:

- ▶ [DHCP Server](#)
- ▶ [DHCP L2 Relay](#)

7.1.1 DHCP Server

[Advanced > DHCP > DHCP Server]

The Dynamic Host Configuration Protocol (DHCP) lets a server assign the IP settings to the devices on the network (clients). The DHCP server stores and assigns the available IP addresses and further settings, if specified.

The DHCP server in the device listens for requests on UDP port 67 and responds to the client devices on UDP port 68. When the device receives a DHCP request, it validates the IP address to be assigned before leasing the IP address and other IP settings to the requesting client device.

The menu contains the following dialogs:

- ▶ [DHCP Server Global](#)
- ▶ [DHCP Server Pool](#)
- ▶ [DHCP Server Lease Table](#)

7.1.1.1 DHCP Server Global

[Advanced > DHCP > DHCP Server > Global]

This dialog lets you activate the *DHCP Server* function either globally or per port according to your requirements.

Operation

Operation

Enables/disables the *DHCP Server* function of the device globally.

Possible values:

- ▶ *On*
- ▶ *Off* (default setting)

Configuration

IP probe

Activates/deactivates the probing for unique IP addresses. Before assigning an IP address, the device sends an *ICMP echo request* packet to check whether this IP address is already in use on the network.

Possible values:

- ▶ *marked* (default setting)
The *IP probe* function is active.
- ▶ *unmarked*
The *IP probe* function is inactive.

Table

For information on how to customize the appearance of the table, see [“Working with tables” on page 16](#).

Port

Displays the number of the physical port on which the device listens for DHCP requests and responds to the client devices.

DHCP server active

Activates/deactivates the *DHCP Server* function on this port.

The prerequisite is that you enable the function globally.

Possible values:

- ▶ **marked** (default setting)
The *DHCP Server* function is active.
- ▶ **unmarked**
The *DHCP Server* function is inactive.

7.1.1.2 DHCP Server Pool

[Advanced > DHCP > DHCP Server > Pool]

In this dialog, you specify the settings for assigning a certain IP address to client devices from which the device receives a DHCP request.

The device assigns an IP address from a specific pool (address range) depending on which physical port the requesting client device is connected to or in which VLAN it is a member. The MAC address of the requesting client device is a further criterion for the pool from which the device assigns an IP address.

If specified, the device processes further information to assign an IP address from a certain pool to the client device. This can be, for example, the following information in the DHCP request:

- *Client ID*
- *Remote ID*
- *Circuit ID*

The device provides a maximum of 128 pools. Up to 1000 client devices can receive their IP settings from the device.

The device manages the IP settings in two types of pools.

- **Static pools**
To assign the same IP address to a specific device each time, the device manages the relevant IP settings in a pool whose address range is exactly one IP address. Static pools are useful, for example, to assign a fixed IP address to a server, NAS, or printer.
- **Dynamic pools**
To assign IP addresses from a certain address range, the device manages the relevant IP settings in a pool whose address range includes multiple IP addresses. Dynamic pools are useful, for example, to assign a certain IP address to client devices that belong to a certain VLAN.

In addition to the IP settings, the device can assign further parameters (DHCP options) to the client devices. Assigning such parameters is a smart way to automatically set up client devices as they obtain their IP settings. The device lets you specify such parameters for each pool.

Table

For information on how to customize the appearance of the table, see [“Working with tables” on page 16](#).

Buttons



Add

Adds a table row.



Remove

Removes the selected table row.

Index

Displays the index number to which the table row relates. The device automatically assigns the value when you add a table row.

Active

Activates/deactivates the DHCP server function on this port.

Possible values:

- ▶ [marked](#)
The DHCP server function is active.
- ▶ [unmarked](#) (default setting)
The DHCP server function is inactive.

IP range start

Specifies the fixed IP address for a static pool or the start IP address of an address range.

Possible values:

- ▶ Valid IPv4 address (default setting: [0.0.0.0](#))

IP range end

Specifies the end IP address of an address range. For a static pool, keep the default setting or add the same value as specified in the [IP range start](#) column.

Possible values:

- ▶ Valid IPv4 address (default setting: [0.0.0.0](#))

Port

Specifies the number of the physical port on which the requesting client device is connected.

Possible values:

- ▶ [ALL](#) (default setting)
The device assigns an IP address to the requesting client device regardless of the port on which the local device receives the DHCP request.
- ▶ [<Port number>](#)
The device assigns an IP address to the requesting client device only if the local device receives the DHCP request on the specified port.
The prerequisite is that the item - is selected from the drop-down list in the [VLAN ID](#) column.

VLAN ID

Specifies the VLAN to which the table row relates. The prerequisite is that the item [ALL](#) is selected from the drop-down list in the [Port](#) column.

Possible values:

- ▶ - (default setting)
- ▶ [1..4042](#)
The value [1](#) represents the VLAN in which device management is accessible in the default setting.

MAC address

Specifies the MAC address of the requesting client device.

Possible values:

- ▶ - (default setting)
For the IP address assignment, the server ignores this variable.
- ▶ Valid Unicast MAC address
Specify the value with a colon separator, for example `00:11:22:33:44:55`.

DHCP relay

Specifies the IP address of the DHCP relay through which the clients transmit their requests to the DHCP server. When the device receives a DHCP request through a different DHCP relay, it ignores this DHCP request.

Possible values:

- ▶ - (default setting)
No DHCP relay specified.
- ▶ Valid IPv4 address
IP address of the DHCP relay.

Client ID

Specifies the customized identifier for the client instead of the MAC address.

Possible values:

- ▶ - (default setting)
The device ignores the parameter during assignment of an IP address from the pool.
- ▶ Sequence of hexadecimal character pairs with 1..254 pairs separated by a space.
Example: `41 42 43 44 4F`

Note: If you have high security requirements and do not want to trust the clients implicitly, consider using the *remote ID* or the *circuit ID* instead of the *client ID*. The *remote ID* and the *circuit ID* are inserted by a DHCP relay and are therefore harder to spoof.

Remote ID

Specifies the *remote ID*. The DHCP relay inserts the *remote ID* into the DHCP request.

Possible values:

- ▶ - (default setting)
The device ignores the parameter during assignment of an IP address from the pool.
- ▶ Sequence of hexadecimal character pairs with 1..254 pairs separated by a space.
Example: `41 42 43 44 4F`

Circuit ID

Specifies the *circuit ID*. The DHCP relay inserts the *circuit ID* into the DHCP request.

Possible values:

- ▶ - (default setting)
The device ignores the parameter during assignment of an IP address from the pool.
- ▶ Sequence of hexadecimal character pairs with 1..254 pairs separated by a space.
Example: `41 42 43 44 4F`

Hirschmann device

Activates/deactivates the Hirschmann multicasts. If the device in this IP address range serves only Hirschmann client devices, then activate this function.

Possible values:

- ▶ **marked**
In this IP address range, the device serves only Hirschmann client devices. The Hirschmann multicasts are activated.
- ▶ **unmarked** (default setting)
In this IP address range, the device serves client devices of different manufacturers. The Hirschmann multicasts are deactivated.

Configuration URL

Specifies the protocol to be used as well as the name and path of the configuration file.

Possible values:

- ▶ Alphanumeric ASCII character string with 0..70 characters
Example: tftp://192.9.200.1/cfg/config.xml

When you leave this field blank, the device leaves this option field blank in the DHCP message.

Lease time [s]

Specifies the limited period in seconds for which the device leases each IP address.

The client device is responsible for renewing the IP address before the period expires. If the client device does not renew its IP address in time, then the IP address returns to the address pool.

Possible values:

- ▶ **60..220752000** (2555 d) (default setting: 86400)
- ▶ **4294967295** ($2^{32}-1$)
Use this value for assignments unlimited in time, and for assignments using BOOTP.

Default gateway

Specifies the IP address of the *default gateway*.

A value of **0.0.0.0** disables the attachment of the option field in the DHCP message.

Possible values:

- ▶ Valid IPv4 address (default setting: **0.0.0.0**)

Netmask

Specifies the mask of the network to which the client belongs.

A value of **0.0.0.0** disables the attachment of the option field in the DHCP message.

Possible values:

- ▶ Valid IPv4 netmask (default setting: 255.255.255.0)

WINS server

Specifies the IP address of the Windows Internet Name Server which converts NetBIOS names.

A value of 0.0.0.0 disables the attachment of the option field in the DHCP message.

Possible values:

- ▶ Valid IPv4 address (default setting: 0.0.0.0)

DNS server

Specifies the IP address of the DNS server.

A value of 0.0.0.0 disables the attachment of the option field in the DHCP message.

Possible values:

- ▶ Valid IPv4 address (default setting: 0.0.0.0)

Hostname

Specifies the hostname.

When you leave this field blank, the device leaves this option field blank in the DHCP message.

Possible values:

- ▶ Alphanumeric ASCII character string with 0..64 characters

7.1.1.3 DHCP Server Lease Table

[Advanced > DHCP > DHCP Server > Lease Table]

This dialog displays the currently assigned IP addresses for each port.

Table

For information on how to customize the appearance of the table, see [“Working with tables” on page 16](#).

Port

Displays the number of the port through which the device to which the IP address is assigned is connected.

IP address

Displays the IP address to which the table row relates.

Status

Displays the lease phase.

According to the standard for DHCP operations, there are 4 phases when assigning an IP address: Discovery, Offer, Request, and Acknowledgement.

Possible values:

- ▶ *BOOTP*
A DHCP client is attempting to discover a DHCP server for IP address allocation.
- ▶ *offering*
The DHCP server is validating that the IP address is suitable for the client.
- ▶ *requesting*
The DHCP client is acquiring the offered IP address.
- ▶ *bound*
The DHCP server is leasing the IP address to a client.
- ▶ *renewing*
The DHCP client is requesting an extension to the lease.
- ▶ *rebinding*
The DHCP server is assigning the IP address to the client after a successful renewal.
- ▶ *declined*
The DHCP server denied the request for the IP address.
- ▶ *released*
The IP address is available for other clients.

Remaining lifetime

Displays how long the assigned IP address is still valid.

Leased MAC address

Displays the MAC address of the device to which the IP address is assigned.

Gateway

Displays the Gateway IP address of the device to which the IP address is assigned.

Client ID

Displays the *client ID* of the device to which the IP address is assigned.

Remote ID

Displays the *remote ID* of the device to which the IP address is assigned.

Circuit ID

Displays the *circuit ID* of the device to which the IP address is assigned.

7.2 DHCP L2 Relay

[Advanced > DHCP L2 Relay]

A network administrator uses the DHCP L2 *Relay Agent* to add DHCP client information. L3 *Relay Agents* and DHCP servers need the DHCP client information to assign an IP address and a configuration to the clients.

When active, the relay adds *Option 82* information configured in this dialog to the packets before it relays DHCP requests from the clients to the server. The *Option 82* fields provide unique information about the client and relay. This unique identifier consists of a *Circuit ID* for the client and a *Remote ID* for the relay.

In addition to the type, length, and multicast fields, the *Circuit ID* includes the VLAN ID, unit number, slot number, and port number for the connected client.

The *Remote ID* consists of a type and length field and either a MAC address, IP address, client identifier, or a user-defined device description. A client identifier is the user-defined system name for the device.

For the DHCPv6 protocol, the device uses a *Relay Agent* to add *Relay Agent* options to DHCPv6 packets exchanged between a client and a DHCPv6 server. The Lightweight DHCPv6 Relay Agent (LDRA) is described in RFC 6221.

The LDRA processes 2 types of messages:

- *Relay-Forward* messages
The *Relay Agent* forwards *Relay-Forward* messages that contain unique information about the client. The client information includes the peer-address, meaning the IPv6 link-local address of the client and the *Interface-ID* information. The *Interface-ID* information, also known as *Option 18*, provides information that identifies the interface on which the client request was sent.
- *Relay-Reply* messages
The DHCPv6 server sends *Relay-Reply* messages. The *Relay Agent* validates the messages to include the information encapsulated in the initial *Relay-Forward* message. If the information is valid, then the *Relay Agent* forwards the packet to the client.

The menu contains the following dialogs:

- ▶ [DHCP L2 Relay Configuration](#)
- ▶ [DHCP L2 Relay Statistics](#)

7.2.1 DHCP L2 Relay Configuration

[Advanced > DHCP L2 Relay > Configuration]

This dialog lets you activate the relay function on an interface and VLAN. When you activate this function on a port, the device either relays the *Option 82* information or drops the information on untrusted ports. Furthermore, the device lets you specify the remote identifier.

The *Option 82* information is specific to DHCPv4 L2 Relay function. For DHCPv6 L2 Relay function, the *Option 18* information is used in the packet exchange between the client and DHCPv6 server. The device discards DHCPv6 packets received on ports that do not contain *Option 18* information.

The dialog contains the following tabs:

- ▶ [Interface]
- ▶ [VLAN ID]

Operation

Operation

Enables/disables the DHCP L2 Relay function of the device globally.

With this function enabled, DHCPv4 L2 Relay and DHCPv6 L2 Relay functions can operate at the same time in the device.

Possible values:

- ▶ *On*
Enables the *DHCP L2 Relay* function in the device.
- ▶ *Off* (default setting)
Disables the *DHCP L2 Relay* function in the device.

[Interface]

Table

For information on how to customize the appearance of the table, see [“Working with tables” on page 16](#).

Port

Displays the port number.

Active

Activates/deactivates the *DHCP L2 Relay* function on the port.

The prerequisite is that you enable the function globally.

Possible values:

- ▶ **marked**
The *DHCP L2 Relay* function is active.
- ▶ **unmarked** (default setting)
The *DHCP L2 Relay* function is inactive.

Trusted port

Activates/deactivates the secure *DHCP L2 Relay* mode for the corresponding port.

Possible values:

- ▶ **marked**
The device accepts DHCPv4 packets with *Option 82* information.
The device accepts DHCPv6 packets with *Option 18* information.
- ▶ **unmarked** (default setting)
The device discards DHCPv4 packets received on non-secure ports that contain *Option 82* information.
The device discards DHCPv6 packets received on ports that do not contain *Option 18* information.

[VLAN ID]

Table

For information on how to customize the appearance of the table, see [“Working with tables” on page 16](#).

VLAN ID

VLAN to which the table row relates.

Active

Activates/deactivates the *DHCP L2 Relay* function in this VLAN.

The prerequisite is that you enable the function globally.

Possible values:

- ▶ **marked**
The *DHCP L2 Relay* function is active.
- ▶ **unmarked** (default setting)
The *DHCP L2 Relay* function is inactive.

Circuit ID

Activates or deactivates the addition of the *Circuit ID* to the *Option 82* information.

Possible values:

- ▶ *marked* (default setting)
Enables *Circuit ID* and *Remote ID* to be sent together.
- ▶ *unmarked*
The device sends only the *Remote ID*.

Remote ID type

Specifies the components of the *Remote ID* for this VLAN. The *Remote ID* field displays the string the device uses as *Remote ID*.

Possible values:

- ▶ *ip*
Specifies the IP address of the device as *Remote ID*.
- ▶ *mac* (default setting)
Specifies the MAC address of the device as *Remote ID*.
- ▶ *client-id*
Specifies the system name of the device as *Remote ID*.
- ▶ *other*
When you select this item, enter any character string in the *Remote ID* column.

Remote ID



Displays the *Remote ID* that the device uses for this VLAN. If the item *other* is selected from the *Remote ID type* drop-down list, then enter any character string.

Possible values:

- ▶ Alphanumeric ASCII character string with 1..32 characters

The device enters ASCII code values into the packet. If the item *client-id* or *other* is selected from the *Remote ID type* drop-down list, then the device processes the ASCII code of the characters. For example, when you enter the string *abc*, the device enters the value *616263* into the packet.

If the device does not accept the string you entered, then perform the following steps:

- Click the  button to undo the unsaved changes in the current dialog.
- From the *Remote ID type* drop-down list, select the item *other*.
- Click the  button without modifying the string.
- Enter the arbitrary string.

7.2.2 DHCP L2 Relay Statistics

[Advanced > DHCP L2 Relay > Statistics]

The device monitors the data stream on the ports and displays the results in tabular form.

This table is divided into various categories to aid you in data stream analysis.

The DHCPv6 relay options are not displayed in the statistics table.

Table

For information on how to customize the appearance of the table, see [“Working with tables” on page 16](#).

Buttons



Resets the counter for the statistics to 0.

Port

Displays the port number.

Untrusted server messages with Option 82

Displays the number of DHCP server messages received with *Option 82* information on the untrusted interface.

Untrusted client messages with Option 82

Displays the number of DHCP client messages received with *Option 82* information on the untrusted interface.

Trusted server messages without Option 82

Displays the number of DHCP server messages received without *Option 82* information on the trusted interface.

Trusted client messages without Option 82

Displays the number of DHCP client messages received without *Option 82* information on the trusted interface.

7.3 Industrial Protocols

[Advanced > Industrial Protocols]

The menu contains the following dialogs:

- ▶ Modbus TCP
- ▶ EtherNet/IP
- ▶ PROFINET

7.3.1 Modbus TCP

[Advanced > Industrial Protocols > Modbus TCP]

Modbus TCP is a protocol used for Supervisory Control and Data Acquisition (SCADA) system integration. *Modbus TCP* is a vendor-neutral protocol used to monitor and control industrial automation equipment such as Programmable Logic Controllers (PLC), sensors and meters.

This dialog lets you specify the parameters of the protocol. To monitor and control the parameters of the device, you need an application with an Human-Machine Interface and the memory mapping table. Refer to the tables located in the “Configuration” user manual for the supported objects and memory mapping.

In the dialog, you can enable the function, activate the write access, and specify on which TCP port the Human-Machine Interface polls for data. You can also specify the number of sessions that can be open at the same time.

Note: Activating the *Modbus TCP* write-access can cause an unavoidable security risk, because the protocol does not authenticate user access.

To help minimize the unavoidable security risks, specify the IP address range located in the *Device Security > Management Access* dialog. Enter only the IP addresses assigned to your devices before enabling the function. Furthermore, the default setting for monitoring function activation in the *Diagnostics > Status Configuration > Security Status* dialog, *Global* tab, is active.

Operation

Operation

Enables/disables the *Modbus TCP* server in the device.

Possible values:

- ▶ *On*
The *Modbus TCP* server is enabled.
- ▶ *Off* (default setting)
The *Modbus TCP* server is disabled.

Configuration

Write access

Activates/deactivates the write access to the *Modbus TCP* parameters.

Note: Activating the *Modbus TCP* write-access can cause an unavoidable security risk, because the protocol does not authenticate user access.

Possible values:

- ▶ **marked** (default setting)

The *Modbus TCP* server read/write access is active. This lets you change the device settings using the *Modbus TCP* function.

- ▶ **unmarked**

The *Modbus TCP* server read-only access is active.

TCP port

Specifies the TCP port number that the *Modbus TCP* server uses for communication.

Possible values:

- ▶ **<TCP Port number>** (default setting: 502)

Specifying 0 is not allowed.

Sessions (max.)

Specifies the maximum number of concurrent sessions that the *Modbus TCP* server maintains.

Possible values:

- ▶ **1..5** (default setting: 5)

7.3.2 EtherNet/IP

[Advanced > Industrial Protocols > EtherNet/IP]

This dialog lets you specify the *EtherNet/IP* settings. You have the following options:

- Enable/disable the *EtherNet/IP* function in the device.
- Specify a VLAN which forwards the *EtherNet/IP* packets exclusively.
- Activate/deactivate the read/write capability of the *EtherNet/IP* function.
- Download the Electronic Data Sheet (EDS) file from the device.

Operation

Operation

Enables/disables the *EtherNet/IP* function in the device.

Possible values:

- ▶ *On*
The *EtherNet/IP* function is enabled.
- ▶ *Off* (default setting)
The *EtherNet/IP* function is disabled.

Configuration

Buttons

 Download EDS file

Copies the following information in a zip file onto your PC:

- Electronic Data Sheet (EDS) with device related information
- Device icon

Write access

Activates/deactivates the read/write capability of the *EtherNet/IP* function.

Possible values:

- ▶ *marked*
The *EtherNet/IP* function accepts set/get requests.
- ▶ *unmarked* (default setting)
The *EtherNet/IP* function accepts only get requests.

VLAN Configuration

VLAN ID

Specifies the VLAN to be used for the *EtherNet/IP* function.

Possible values:

▶ **mgmt** (default setting)

The *EtherNet/IP* function uses the VLAN, in which the device management is accessible through the network. You specify this VLAN in the *Basic Settings > Network > Global* dialog, *Management interface* frame, *VLAN ID* field.

▶ **1..4042**

The *EtherNet/IP* function uses the selected VLAN.

Prerequisites:

- The VLAN is already set up in the device.
See the *Switching > VLAN > Configuration* dialog.
- The port over which the device forwards the *EtherNet/IP* packets is a member of the VLAN you assign and transmits the data packets with a VLAN tag.
See the *Switching > VLAN > Configuration* dialog.
- The *IP Access Restriction* function is enabled.
See the *Device Security > Management Access > IP Access Restriction* dialog.

7.3.3 PROFINET

[Advanced > Industrial Protocols > PROFINET]

This dialog lets you set up the PROFINET protocol on this device used in conjunction with PROFINET Controllers and PROFINET devices. The device bases the *PROFINET* function on the Siemens V2.2 PROFINET stack for common Ethernet controllers. The PROFINET protocol implemented in the device conforms to Class B for real time responses according to IEC 61158.

Prerequisites for using the PROFINET function

Functions that directly affect the *PROFINET* function require the following default values to be changed. If you have obtained the device as a specially available *PROFINET* variant, then these values are already predefined:

PROFINET

Advanced > Industrial Protocols > PROFINET dialog

- *Operation* frame
Operation = *On*
- *Configuration* frame
Name of station field = <empty>

Network

Basic Settings > Network > IPv4 dialog

- *Management interface* frame
IP address assignment radio button = *Local*
- *HiDiscovery protocol v1/v2* frame
Access drop-down list = *readOnly*
- *IP parameter* frame
IP address field = *0.0.0.0*
Netmask field = *0.0.0.0*
Gateway address field = *0.0.0.0*

VLAN

Switching > Global dialog

- *Configuration* frame
VLAN-unaware mode checkbox = *marked*

LLDP

Diagnostics > LLDP > Configuration dialog

- *Configuration* frame
Transmit interval [s] field = *5*
Transmit delay [s] field = *1*

Operation

Operation

Enables/disables the *PROFINET* function in the device.

Possible values:

- ▶ *On*
The *PROFINET* function is enabled.
- ▶ *off* (default setting)
The *PROFINET* function is disabled.

Configuration

Buttons

 Download GSDML file

Copies the GSDML file onto your PC.

Name of station

Specifies the name of the device.

Possible values:

- ▶ Alphanumeric ASCII character string with 0..240 characters
The device prohibits you from using a number as the first character.

Information

Active application relations

Displays how many application relations are active.

Table

For information on how to customize the appearance of the table, see [“Working with tables” on page 16](#).

Port

Displays the port number.

DCP mode

Specifies the data stream direction on the port to monitor for DCP packets.

The Programmable Logic Controllers (PLCs) detects PROFINET devices using the Discovery and Configuration Protocol (DCP).

The DCP identify request packets are multicast, the responses from the agents are unicast. Regardless of the settings, the device forwards the received DCP packets to other ports whose setting is either *egress* or *both*.

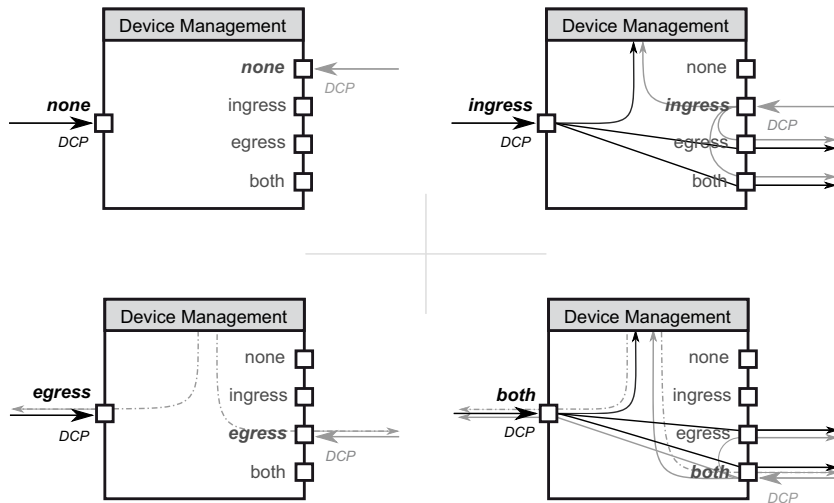

Possible values:

- ▶ *none*
The agent does not respond to packets received on this port. The port does not forward packets received on other ports.
- ▶ *ingress*
The agent responds to packets received on this port. The port does not forward packets received on other ports.
- ▶ *egress*
The agent does not respond to packets received on this port. The port forwards packets received on other ports.
- ▶ *both* (default setting)
The agent responds to packets received on this port. The port forwards packets received on other ports.

7.4 Command Line Interface

[Advanced > CLI]

This dialog lets you access the device using the Command Line Interface.

Prerequisites:

- In the [Device Security > Management Access > Server](#) dialog, [SSH](#) tab the SSH server is enabled.
- On your workstation, install a SSH-capable client application which registers a handler for URLs starting with `ssh://` in your operating system.

Buttons

Open SSH connection

Opens the SSH-capable client application.

When you click the button, the web application passes the URL of the device starting with `ssh://` and the user name of the currently logged in user.

If the web browser finds an SSH-capable client application, then the SSH-capable client establishes a connection to the device management using the SSH protocol.

A Index

0-9	
802.1D/p mapping	227
802.1X	111, 148
A	
Access control	148
Access control lists	178
Access restriction	128
ACL	178
Address conflict detection	25, 301
Aging time	189
Alarm	290
ARP	301
ARP table	60, 305
Audit trail	351
Authentication history	161
Authentication list	111
Auto disable	144, 145, 249, 319, 320, 327
B	
Boundary clock	75
Bridge	246
C	
Cable diagnosis	314
Certificate	21, 41, 125, 126, 280
CLI	133
Command line interface	133
Community names	135
Configuration check	299
Configuration profile	16, 37
Counter reset	59
D	
Daylight saving time	62
Default gateway	359
Device software	33
Device software backup	33
Device status	19, 272
DHCP L2 Relay	362
DHCP server	353
DHCPv6 L2 Relay	362
Digital certificate	21, 41, 126, 280
DoS	174
Download EDS for EtherNet/IP	370
DSCP	228
Duplicate Address Detection	31

E	
EAPOL	159
Egress rate limiter	192
Encryption	37
ENVM	36, 42, 44, 49, 273, 279, 286, 348
EtherNet/IP	281, 370
EtherNet/IP, Download EDS	370
EtherNet/IP, Read/write capability	370
EtherNet/IP, VLAN	370
Event severity	346
External memory	23, 36, 42, 44, 49, 348
F	
FAQ	383
FDB (MAC address table)	59, 195
Filter MAC addresses	195
Fingerprint	122, 126
Flash memory	36, 298
Flow control	189
G	
GARP	221
Guards	256
GVRP	222
H	
Hardware clock	61
Hardware state	298
HiDiscovery	25, 280, 351
Host key	122
HTML	297, 350
HTTP	123
HTTP server	278
HTTPS	124
Humidity	22
I	
IAS	111, 163
IEEE 802.1X	111
IGMP snooping	60, 197
Industrial HiVision	9, 117
Ingress filtering	238
Ingress rate limiter	192
Integrated authentication server	111, 163
IP access restriction	128
IP address conflict detection	301
IP DSCP mapping	228
IPv4 rule	180
L	
L2 Relay (DHCP)	362
Link aggregation	259
Link backup	266
LLDP	333
Load/save	37
Log file	59, 60, 350
Login banner	134, 136
Loops	245

M	
MAC Address Conflict Detection	25
MAC flood	143
MAC rule	184
MAC spoof	145
MAC address table (forwarding database)	59, 195
Management access	25, 30, 128
Management VLAN	25
Media redundancy protocol	242
MMRP	213
Modbus TCP	281, 368
MRP	242
MRP-IEEE	211
MTU	55
MVRP	218
N	
Network load	57
NVM	16, 36, 42
P	
Password	106, 277
Password length	106, 277
Persistent log file	60
Persistent logging	347
Port clients	157
Port configuration	151, 225
Port mirroring	331
Port monitor	327
Port priority	225
Port security	143
Port statistics	60, 159
Port VLAN	237
Port-based access control	148
Power supply	21, 274, 287
Pre-Login banner	136
Priority queue	224
PROFINET	281, 372
Q	
Queue management	230
Queues	224
R	
RADIUS	111, 164
RAM	41
RAM test	307
Rate limiter	192
Read/write capability for EtherNet/IP	370
Reboot	59
Relay (DHCP)	362
Request interval	67
Ring structure	242
Root bridge	246
RSTP	245, 246

S	
Secure Shell (SSH)	119
Security status	20, 276
Self-test	307
Serial interface	279
Settings	37
Severity	346
SFP module	313
Signal contact	20, 283
SNMP server	117, 279
SNMP traps	55, 145, 246, 263, 272, 276, 285, 290, 303, 319
SNMPv1/v2	135
SNTP	65
SNTP client	66
SNTP server	70
Software backup	33
Software update	33
Spanning tree protocol	245
SSH server	119
Support information	343
Support information (ZIP archive)	346
Syslog	309
System information	297
System log	350
System monitor	307
System time	61
T	
Technical questions	383
Telnet server	118, 278
Temperature	22, 273, 274, 286, 287
Threshold values network load	192
Topology discovery	338
Training courses	383
Transparent clock	84
Trap destination	294
Traps	55, 145, 246, 263, 272, 276, 285, 290, 303, 319
Trust mode	225
Twisted-pair	314
U	
Unaware mode	189
Unsigned device software (allow upload)	35
Uptime	22, 298
User administration	105
Utilization	57
V	
Virtual local area network	231
VLAN	25, 231
VLAN configuration	234
VLAN for EtherNet/IP	370
VLAN ports	237
VLAN-unaware mode	189
W	
Watchdog	37, 46
Web server	123, 124

Z

ZIP archive with support information 346

B Technical support

Technical questions

For technical questions, please contact any Hirschmann dealer in your area or Hirschmann directly. You find the addresses of our partners on the Internet at www.belden.com.

For technical support, visit hirschmann-support.belden.com. This site also includes a free of charge knowledge base and a software download section.

Technical Documents

The current manuals and operating instructions for Hirschmann products are available at doc.hirschmann.com.

Customer Innovation Center

The Customer Innovation Center is ahead of its competitors on three counts with its complete range of innovative services:

- ▶ Consulting incorporates comprehensive technical advice, from system evaluation through network planning to project planning.
- ▶ Training offers you an introduction to the basics, product briefing and user training with certification. You find the training courses on technology and products currently available at www.belden.com/solutions/customer-innovation-center.
- ▶ Support ranges from the first installation through the standby service to maintenance concepts.

With the Customer Innovation Center, you decide against any compromise in any case. Our client-customized package leaves you free to choose the service components you want to use.

C Readers' Comments

What is your opinion of this manual? We are constantly striving to provide as comprehensive a description of our product as possible, as well as important information to assist you in the operation of this product. Your comments and suggestions help us to further improve the quality of our documentation.

Your assessment of this manual:

	Very Good	Good	Satisfactory	Mediocre	Poor
Precise description	<input type="radio"/>	<input type="radio"/>	<input type="radio"/>	<input type="radio"/>	<input type="radio"/>
Readability	<input type="radio"/>	<input type="radio"/>	<input type="radio"/>	<input type="radio"/>	<input type="radio"/>
Understandability	<input type="radio"/>	<input type="radio"/>	<input type="radio"/>	<input type="radio"/>	<input type="radio"/>
Examples	<input type="radio"/>	<input type="radio"/>	<input type="radio"/>	<input type="radio"/>	<input type="radio"/>
Structure	<input type="radio"/>	<input type="radio"/>	<input type="radio"/>	<input type="radio"/>	<input type="radio"/>
Comprehensive	<input type="radio"/>	<input type="radio"/>	<input type="radio"/>	<input type="radio"/>	<input type="radio"/>
Graphics	<input type="radio"/>	<input type="radio"/>	<input type="radio"/>	<input type="radio"/>	<input type="radio"/>
Drawings	<input type="radio"/>	<input type="radio"/>	<input type="radio"/>	<input type="radio"/>	<input type="radio"/>
Tables	<input type="radio"/>	<input type="radio"/>	<input type="radio"/>	<input type="radio"/>	<input type="radio"/>

Did you discover any errors in this manual?
If so, on what page?

Suggestions for improvement and additional information:

General comments:

Sender:

Company / Department:

Name / Telephone number:

Street:

Zip code / City:

E-mail:

Date / Signature:

Dear User,

Please fill out and return this page

- ▶ as a fax to the number +49 (0)7127/14-1600 or
- ▶ per mail to
Hirschmann Automation and Control GmbH
Department IRD-NT
Stuttgarter Str. 45-51
72654 Neckartenzlingen
Germany



HIRSCHMANN

A **BELDEN** BRAND



HIRSCHMANN

A **BELDEN** BRAND

User Manual

Configuration

GREYHOUND Switch GRS105/106/115/116

HiOS-2S

The naming of copyrighted trademarks in this manual, even when not specially indicated, should not be taken to mean that these names may be considered as free in the sense of the trademark and tradename protection law and hence that they may be freely used by anyone.

© 2024 Hirschmann Automation and Control GmbH

Manuals and software are protected by copyright. All rights reserved. The copying, reproduction, translation, conversion into any electronic medium or machine scannable form is not permitted, either in whole or in part. An exception is the preparation of a backup copy of the software for your own use.

The performance features described here are binding only if they have been expressly agreed when the contract was made. This document was produced by Hirschmann Automation and Control GmbH according to the best of the company's knowledge. Hirschmann reserves the right to change the contents of this document without prior notice. Hirschmann can give no guarantee in respect of the correctness or accuracy of the information in this document.

Hirschmann can accept no responsibility for damages, resulting from the use of the network components or the associated operating software. In addition, we refer to the conditions of use specified in the license contract.

You find the latest user documentation for your device at: doc.hirschmann.com

Hirschmann Automation and Control GmbH
Stuttgarter Str. 45-51
72654 Neckartenzlingen
Germany

Contents

	Safety instructions	11
	About this Manual	13
	Key	14
	Replacing a device	15
1	User interfaces	17
1.1	Graphical User Interface	17
1.2	Command Line Interface	18
1.2.1	Preparing the data connection	18
1.2.2	Access to the Command Line Interface using the Secure Shell (SSH)	18
1.2.3	Access to the Command Line Interface using the serial interface	21
1.2.4	Mode-based command hierarchy	22
1.2.5	Executing the commands	26
1.2.6	Structure of a command	26
1.2.7	Examples of commands	29
1.2.8	Input prompt	30
1.2.9	Key combinations	31
1.2.10	Data entry elements	33
1.2.11	Use cases	34
1.2.12	Service Shell	35
1.3	System monitor	38
1.3.1	Functional scope	38
1.3.2	Starting the System Monitor	38
2	Specifying the IP parameters	41
2.1	IP parameter basics	41
2.1.1	IPv4	41
2.1.2	IPv6	45
2.2	Specifying the IP parameters using the Command Line Interface	50
2.2.1	IPv4	50
2.2.2	IPv6	51
2.3	Specifying the IP parameters using HiDiscovery	53
2.4	Specifying the IP parameters using the Graphical User Interface	55
2.4.1	IPv4	55
2.4.2	IPv6	56
2.5	Specifying the IP parameters using BOOTP	57
2.6	Specifying the IP parameters using DHCP	58
2.6.1	IPv4	58
2.6.2	IPv6	59
2.7	Management address conflict detection	61
2.7.1	Active and passive detection	61
2.8	Duplicate Address Detection function	62
3	Access to the device	63
3.1	First login (Password change)	63

3.2	Authentication lists	64
3.2.1	Applications	64
3.2.2	Policies	64
3.2.3	Managing authentication lists	64
3.2.4	Adjusting the settings	65
3.3	User management	67
3.3.1	Access roles	67
3.3.2	Managing user accounts	69
3.3.3	Default user accounts	69
3.3.4	Changing default passwords	69
3.3.5	Setting up a new user account	70
3.3.6	Deactivating the user account	71
3.3.7	Adjusting policies for passwords	72
3.4	SNMP access	74
3.4.1	SNMPv1/v2 access	74
3.4.2	SNMPv3 access	74
3.4.3	<i>SNMPv3 traps</i>	75
4	Synchronizing the system time in the network	79
4.1	Setting the time	79
4.2	Automatic daylight saving time changeover	81
4.2.1	Setting daylight saving time using pre-defined profiles	81
4.2.2	Setting daylight saving time manually	81
4.3	Synchronizing time in the network with SNTP	83
4.3.1	Preparation	84
4.3.2	Defining settings of the SNTP client	85
4.3.3	Specifying SNTP server settings	86
4.4	Synchronizing time in the network with PTP	88
4.4.1	Types of clocks	88
4.4.2	Best Master Clock algorithm	89
4.4.3	Delay measurement	89
4.4.4	PTP domains	90
4.4.5	Using PTP	90
4.5	Synchronizing time in the network with 802.1AS	91
4.5.1	Instances and domains	91
4.5.2	Best Master Clock algorithm	91
4.5.3	Enabling the 802.1AS function	92
4.5.4	Disabling the 802.1AS function globally	93
4.5.5	Disabling the 802.1AS function for an instance	93
4.5.6	Disabling the 802.1AS function on a port	94
5	Managing configuration profiles	95
5.1	Detecting changed settings	95
5.1.1	Volatile memory (RAM) and non-volatile memory (NVM)	95
5.1.2	External memory (ACA) and non-volatile memory (NVM)	96
5.2	Saving the settings	97
5.2.1	Saving the configuration profile in the device	97
5.2.2	Saving the configuration profile in the external memory	99
5.2.3	Backing up the configuration profile on a remote server	99
5.2.4	Exporting a configuration profile	100

5.3	Loading settings	102
5.3.1	Activating a configuration profile	102
5.3.2	Loading the configuration profile from the external memory	102
5.3.3	Importing a configuration profile.	104
5.4	Resetting the device to the default setting	107
5.4.1	Using the Graphical User Interface or Command Line Interface	107
5.4.2	Using the System Monitor	107
6	Updating the device software	109
6.1	Loading a previous device software version	109
6.2	Software update from the PC.	110
6.3	Software update from a server.	111
6.3.1	Software update from an FTP server.	111
6.3.2	Software update from a TFTP server.	112
6.3.3	Software update from an SFTP server.	113
6.3.4	Software update from an SCP server	115
6.4	Software update from the external memory.	116
6.4.1	Manually—initiated by the administrator	116
6.4.2	Automatically—initiated by the device	116
7	Configuring the ports	119
7.1	Enabling/Disabling the port	119
7.2	Selecting the operating mode	120
7.3	Gigabit Ethernet mode for ports.	121
7.3.1	Checking port parameters	121
8	Assistance in the protection from unauthorized access	123
8.1	Changing the SNMPv1/v2 community	123
8.2	Disabling SNMPv1/v2	124
8.3	Disabling HTTP	125
8.4	Disabling Telnet	126
8.5	Disabling the HiDiscovery access	127
8.6	Restricting access to device management.	128
8.6.1	Restricting access from a specific IP address range	128
8.7	Adjusting the session timeouts.	130
8.8	Making SSH hosts known to the device.	132
9	Controlling the data traffic	135
9.1	Helping protect against DoS attacks	135
9.1.1	Filters for <i>TCP</i> and <i>UDP</i> packets	136
9.1.2	Filters for <i>IP</i> packets	140
9.1.3	Filters for <i>ICMP</i> packets.	140
9.2	ACL	143
9.2.1	Creating and editing IPv4 rules	144
9.2.2	Creating and configuring an IP ACL using the Command Line Interface.	145
9.2.3	Creating and editing MAC rules	145
9.2.4	Creating and configuring a MAC ACL using the Command Line Interface	146
9.2.5	Assigning ACLs to a port or VLAN	147

10	Network load control	149
10.1	Direct packet distribution	149
10.1.1	Learning MAC addresses	149
10.1.2	Aging of learned MAC addresses	149
10.1.3	Static address entries	150
10.2	Multicasts	153
10.2.1	Example of a Multicast application	153
10.2.2	IGMP snooping	153
10.3	Rate limiter	158
10.4	QoS/Priority	159
10.4.1	Description of prioritization	159
10.4.2	Handling of received priority information	160
10.4.3	VLAN tagging	160
10.4.4	IP ToS (Type of Service)	161
10.4.5	Handling of <i>traffic classes</i>	162
10.4.6	Queue management	163
10.4.7	Management prioritization	165
10.4.8	Setting prioritization	166
10.5	Flow control	170
10.5.1	Flow Control with a half-duplex link	170
10.5.2	Flow Control with a full-duplex link	171
10.5.3	Setting up the Flow Control	171
11	VLANs	173
11.1	Examples of VLANs	173
11.1.1	Application example of a simple port-based VLAN	174
11.1.2	Application example of a complex VLAN setup	177
11.2	Guest VLAN / Unauthenticated VLAN	182
11.3	RADIUS VLAN assignment	184
11.4	Creating a Voice VLAN	185
11.5	VLAN unaware mode	186
12	Redundancy	187
12.1	Network Topology vs. Redundancy Protocols	187
12.1.1	Network topologies	187
12.1.2	Redundancy Protocols	188
12.1.3	Combinations of redundancy protocols	189
12.2	Media Redundancy Protocol (MRP)	190
12.2.1	Network structure	190
12.2.2	Reconfiguration time	191
12.2.3	<i>Advanced mode</i>	191
12.2.4	Prerequisites for MRP	191
12.2.5	Advanced Information	192
12.2.6	Application example of an MRP Ring	193
12.3	Spanning Tree	197
12.3.1	Basics	197
12.3.2	Rules for Creating the Tree Structure	201
12.3.3	Examples	203

12.4	Rapid Spanning Tree Protocol	206
12.4.1	Port roles	206
12.4.2	Port states	207
12.4.3	Spanning Tree Priority Vector	208
12.4.4	Fast reconfiguration	208
12.4.5	Configuring the device	209
12.4.6	Guards	211
12.5	Link Aggregation	215
12.5.1	Methods of Operation	215
12.5.2	Link Aggregation Example	216
12.6	Link Backup	217
12.6.1	Fail Back Description	217
12.6.2	Application example for the Link Backup function	217
13	Operation diagnosis	219
13.1	Sending SNMP traps	219
13.1.1	List of SNMP traps	219
13.1.2	SNMP traps for configuration activity	221
13.1.3	SNMP trap setting	221
13.1.4	ICMP messaging	221
13.2	Monitoring the Device Status	222
13.2.1	Events which can be monitored	222
13.2.2	Configuring the Device Status	223
13.2.3	Displaying the Device Status	225
13.3	Security Status	226
13.3.1	Events which can be monitored	226
13.3.2	Configuring the Security Status	227
13.3.3	Displaying the Security Status	229
13.4	Out-of-Band signaling	230
13.4.1	Controlling the Signal contact	230
13.4.2	Monitoring the Device and Security Statuses	231
13.5	Port event counter	234
13.5.1	Detecting non-matching duplex modes	234
13.6	Auto-Disable	236
13.7	Displaying the SFP status	238
13.8	Topology discovery	239
13.8.1	Displaying the Topology discovery results	239
13.8.2	LLDP-Med	240
13.9	Detecting loops	241
13.10	Reports	242
13.10.1	Global settings	242
13.10.2	Syslog	243
13.10.3	System Log	245
13.10.4	Audit Trail	247
13.11	Network analysis with TCPdump	248
13.12	Monitoring the data stream with Port Mirroring	249
13.12.1	Enabling the Port Mirroring function	250
13.13	Self-test	251
13.14	Copper cable test	253

14	Advanced functions of the device	255
14.1	DHCP server	255
14.1.1	Settings that the server assigns to the clients	255
14.1.2	Pools	255
14.2	DHCP L2 Relay	258
14.2.1	Circuit and Remote IDs	258
14.2.2	DHCP L2 Relay configuration	259
14.3	MRP-IEEE	261
14.3.1	MRP operation	261
14.3.2	MRP timers	261
14.3.3	MMRP	262
14.3.4	MVRP	263
15	Industry Protocols	267
15.1	Modbus TCP function.	267
15.1.1	Client/Server Modbus TCP/IP Mode	268
15.1.2	Supported Functions and Memory Mapping	268
15.1.3	Application example for the Modbus TCP function	272
15.2	EtherNet/IP function.	275
15.2.1	Integration into a Control System.	275
15.2.2	EtherNet/IP Entity Parameters	276
15.3	PROFINET function	293
15.3.1	Device Models for PROFINET GSDML Version 2.41	293
15.3.2	Graphical User Interface and Command Line Interface	294
15.3.3	Integrating the device into a Control System	294
15.3.4	Incorporating the device in the configuration	296
15.3.5	PROFINET parameters	348
A	Setting up the configuration environment.	355
A.1	Setting up a DHCP/BOOTP server	355
A.2	Setting up a DHCP server with Option 82	358
A.3	Preparing access using SSH	361
A.3.1	Generating a key in the device.	361
A.3.2	Transferring your own key onto the device	361
A.3.3	Preparing the SSH client program	362
A.4	HTTPS certificate	364
A.4.1	HTTPS certificate management.	364
A.4.2	Access through HTTPS	365
B	Appendix.	367
B.1	Literature references	367
B.2	Maintenance.	368
B.3	Management Information Base (MIB)	369
B.4	List of RFCs	371
B.5	Underlying IEEE Standards	373
B.6	Underlying IEC Norms	374
B.7	Underlying ANSI Norms	375
B.8	Technical Data	376
15.3.6	Switching	376
15.3.7	VLAN	376
15.3.8	Access Control Lists (ACL)	376
B.9	Copyright of integrated Software	377

B.10	Abbreviations used	378
C	Index	381
D	Technical support	387
E	Readers' Comments	388

Safety instructions

WARNING

UNCONTROLLED MACHINE ACTIONS

To avoid uncontrolled machine actions caused by data loss, configure all the data transmission devices individually.

Before you start any machine which is controlled via data transmission, be sure to complete the configuration of all data transmission devices.

Failure to follow these instructions can result in death, serious injury, or equipment damage.

About this Manual

The “Configuration” user manual contains the information you need to start operating the device. It takes you step by step from the first startup operation through to the basic settings for operation in your environment.

The “Installation” user manual contains a device description, safety instructions, a description of the display, and the other information that you need to install the device.

The “Graphical User Interface” reference manual contains detailed information on using the graphical user interface to operate the individual functions of the device.

The “Command Line Interface” reference manual contains detailed information on using the Command Line Interface to operate the individual functions of the device.

The Industrial HiVision Network Management software provides you with additional options for smooth configuration and monitoring:

- ▶ Auto-topology discovery
- ▶ Browser interface
- ▶ Client/server structure
- ▶ Event handling
- ▶ Event log
- ▶ Simultaneous configuration of multiple devices
- ▶ Graphical user interface with network layout
- ▶ SNMP/OPC gateway

Key

The designations used in this manual have the following meanings:

▶	List
□	Work step
Link	Cross-reference with link
Note:	A note emphasizes a significant fact or draws your attention to a dependency.
<code>Courier</code>	Representation of a CLI command or field contents in the graphical user interface

 Execution in the Graphical User Interface

 Execution in the Command Line Interface

Replacing a device

The device provides the following plug-and-play solutions for replacing a device with a device of the same type, for instance, if a failure was detected or for preventive maintenance:

- ▶ The new device loads the configuration profile of the replaced device from the external memory.
[See “Loading the configuration profile from the external memory” on page 102.](#)
- ▶ The new device gets its IP address using DHCP *Option 82*.
[See “DHCP L2 Relay” on page 258.](#)
[See “Setting up a DHCP server with Option 82” on page 358.](#)

With each solution, upon reboot, the new device gets the same IP settings that the replaced device had.

- ▶ For accessing the device management using HTTPS, the device uses a digital certificate. You have the option to transfer your own digital certificate onto the device.
[See “HTTPS certificate management” on page 364.](#)
- ▶ For accessing the device management using SSH, the device uses an RSA host key. You have the option to import your own host key in PEM format to the device.
[See “Transferring your own key onto the device” on page 361.](#)

1 User interfaces

The device lets you specify the settings of the device using the following user interfaces.

Table 1: User interfaces for accessing the device management

User interface	Can be reached through ...	Prerequisite
Graphical User Interface	Ethernet (In-Band)	Web browser
Command Line Interface	Ethernet (In-Band) Serial interface (Out-of-Band)	Terminal emulation software
System monitor	Serial interface (Out-of-Band)	Terminal emulation software

1.1 Graphical User Interface

System requirements

To open the Graphical User Interface, you need the desktop version of a web browser with HTML5 support.

Note: Third-party software applications such as web browsers validate digital certificates based on criteria such as their expiration date and current cryptographic parameter recommendations. Outdated certificates may cause issues due to invalid or outdated information. Example: A digital certificate has expired or the cryptographic recommendations have changed. To solve validation conflicts with third-party software applications, transfer your own up-to-date digital certificate onto the device or regenerate a self-signed digital certificate with the latest device software.

Starting the Graphical User Interface

The prerequisite for starting the Graphical User Interface is that the IP parameters are set up in the device. See [“Specifying the IP parameters” on page 41](#).

Perform the following steps:

- Start your web browser.
- Type the IP address of the device in the address field of the web browser.
Use the following form: `https://xxx.xxx.xxx.xxx`
The web browser sets up the connection to the device and displays the login dialog.
- When you want to change the language of the Graphical User Interface, click the appropriate link in the top right corner of the login dialog.
- Enter the user name.
- Enter the password.
The default password is `private`.
After you enter the default password for the first time, the device will prompt you to assign a new password.
- Click the [Login](#) button.
The web browser displays the Graphical User Interface.

1.2 Command Line Interface

The Command Line Interface lets you use the functions of the device through a local or remote connection.

The Command Line Interface provides IT specialists with a familiar environment for configuring IT devices. As an experienced user or administrator, you have knowledge about the basics and about using Hirschmann devices.

1.2.1 Preparing the data connection

Information for assembling and starting up your device can be found in the “Installation” user manual.

- Connect the device with the network. The prerequisite for a successful data connection is the correct setting of the network parameters.

You can access the user interface of the Command Line Interface for example, with the freeware program *PuTTY*. You can download the software from www.chiark.greenend.org.uk/~sgtatham/putty/.

- Install the *PuTTY* program on your computer.

1.2.2 Access to the Command Line Interface using the Secure Shell (SSH)

In the following example, you use the *PuTTY* program. Another option to access your device using SSH is the OpenSSH Suite.

Perform the following steps:

- Start the *PuTTY* program on your computer.

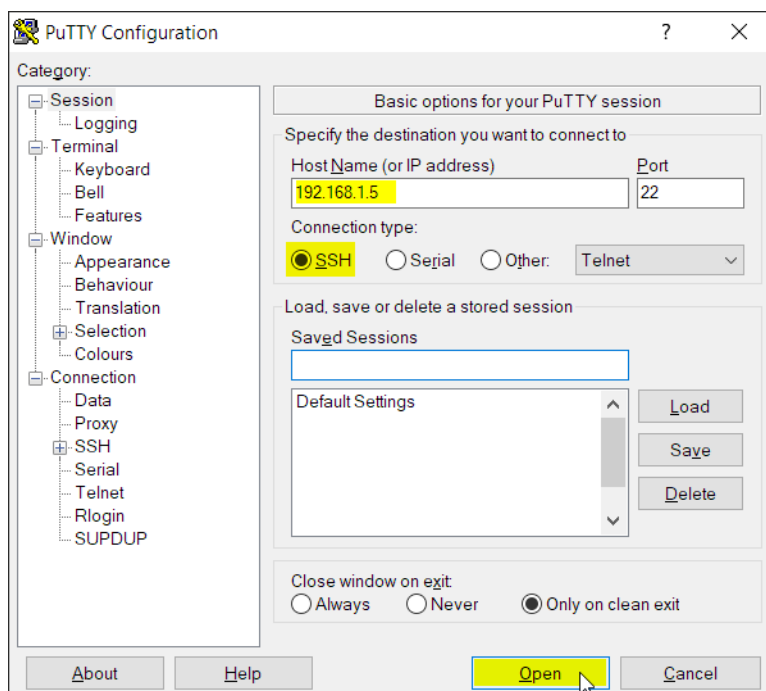

Figure 1: PuTTY input screen

- In the *Host Name (or IP address)* field you enter the IP address of your device. The IP address consists of 4 decimal numbers with values from 0 to 255. The 4 decimal numbers are separated by points.
- To specify the connection type, select the *SSH* radio button in the *Connection type* option list. After selecting and setting the required parameters, the device lets you set up the data connection using SSH.
- Click the *Open* button to set up the data connection to your device. Depending on the device and the time at which SSH was set up, establishing the connection takes up to a minute. When you first log into the device management, towards the end of the connection setup, the *PuTTY* program displays a security alert message and lets you check the fingerprint of the key.

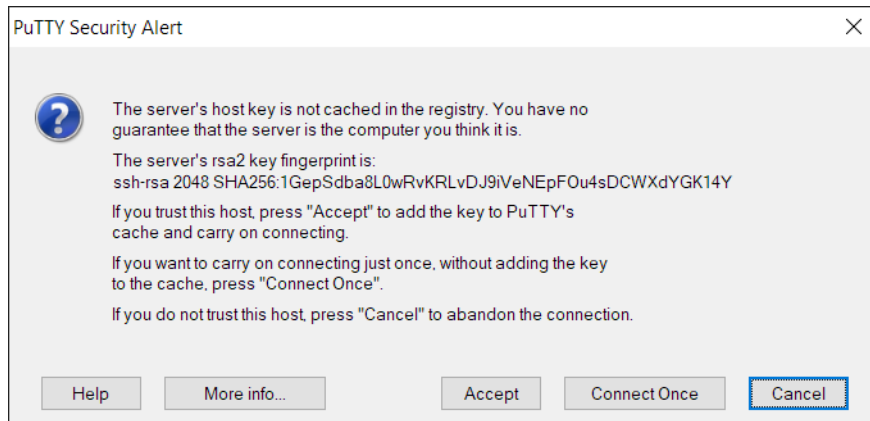

Figure 2: Security alert prompt for the fingerprint

- Check the fingerprint. This helps protect yourself from unwelcome guests.
- When the fingerprint matches the fingerprint of the device key, click the *Yes* button. The device lets you display the finger prints of the device keys with the command `show ssh` or in the *Device Security > Management Access > Server* dialog, *SSH* tab. The Command Line Interface appears on the screen with a window for entering the user name. The device enables up to 5 users to have access to the Command Line Interface at the same time.
- Enter the user name. The default user name is `admin`.
- Press the <Enter> key.

- Enter the password.
The default password is [private](#).
After you enter the default password for the first time, the device will prompt you to assign a new password.
- Press the <Enter> key.

```
login as: admin
admin@192.168.1.5's password:
```

```
Copyright (c) 2011-2024 Hirschmann Automation and Control GmbH
```

```
All rights reserved
```

```
GRS106-6x16c Release HiOS-2S-10.0.00
```

```
(Build date 2024-08-24 16:39)
```

```
System Name   : GRS106-ECE555d6e754
Management IP : 192.168.1.5
Subnet Mask   : 255.255.255.0
Base MAC      : EC:E5:55:01:02:03
System Time   : 2024-08-26 19:50:37
```

```
NOTE: Enter '?' for Command Help. Command help displays all options
      that are valid for the particular mode.
      For the syntax of a particular command form, please
      consult the documentation.
```

```
GRS>
```

Figure 3: Start screen of the Command Line Interface

1.2.3 Access to the Command Line Interface using the serial interface

The serial interface is used to locally connect an external network management station (VT100 terminal or PC with terminal emulation). The interface lets you set up a data connection to the Command Line Interface and to the system monitor.

Perform the following steps:

- Connect the device to a terminal using the serial interface. As an alternative, connect the device to a COM port of your PC using terminal emulation based on VT100 and press any key.
- As an alternative, you set up the serial data connection to the device with the serial interface using the *PuTTY* program. Press the <Enter> key.

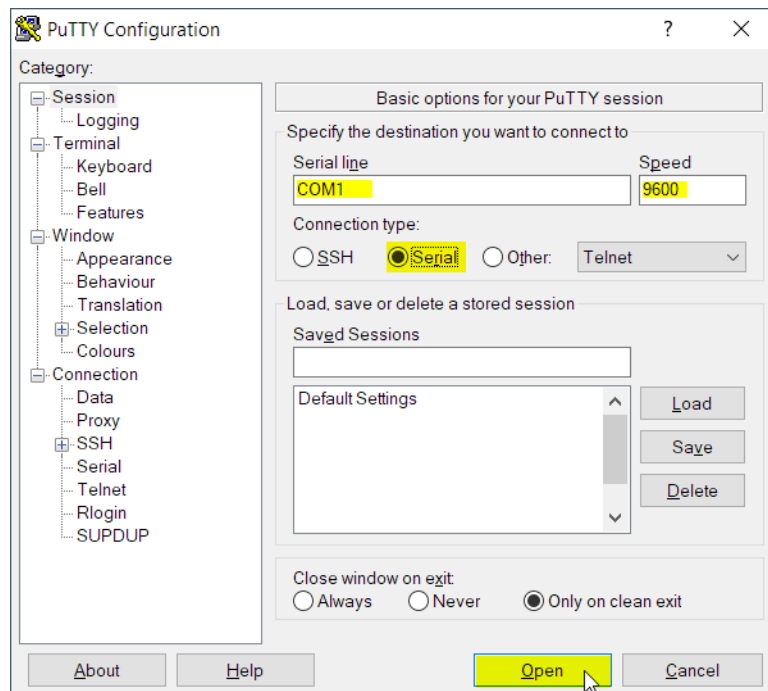

Figure 4: Serial data connection with the serial interface using the PuTTY program

- Press any key on your terminal keyboard a number of times until the login screen indicates the CLI mode.
- Enter the user name.
The default user name is `admin`.
- Press the <Enter> key.

- Enter the password.
The default password is [private](#).
After you enter the default password for the first time, the device will prompt you to assign a new password.
- Press the <Enter> key.

Copyright (c) 2011-2024 Hirschmann Automation and Control GmbH

All rights reserved

GRS106-6x16c Release HiOS-25-10.0.00

(Build date 2024-08-24 16:39)

System Name : GRS106-ECE555d6e754
Management IP : 192.168.1.5
Subnet Mask : 255.255.255.0
Base MAC : EC:E5:55:01:02:03
System Time : 2024-08-26 19:50:37

NOTE: Enter '?' for Command Help. Command help displays all options that are valid for the particular mode.
For the syntax of a particular command form, please consult the documentation.

GRS>

Figure 5: Start screen of the Command Line Interface

1.2.4 Mode-based command hierarchy

In the Command Line Interface, the commands are grouped in the related modes, according to the type of the command. Every command mode supports specific Hirschmann software commands.

The commands available to you as a user depend on your privilege level ([administrator](#), [operator](#), [guest](#), [auditor](#)). They also depend on the mode in which you are currently working. When you switch to a specific mode, the commands of the mode are available to you.

The *User Exec* mode commands are an exception. The Command Line Interface also lets you execute these commands in the *Privileged Exec* mode.

The following figure displays the modes of the Command Line Interface.

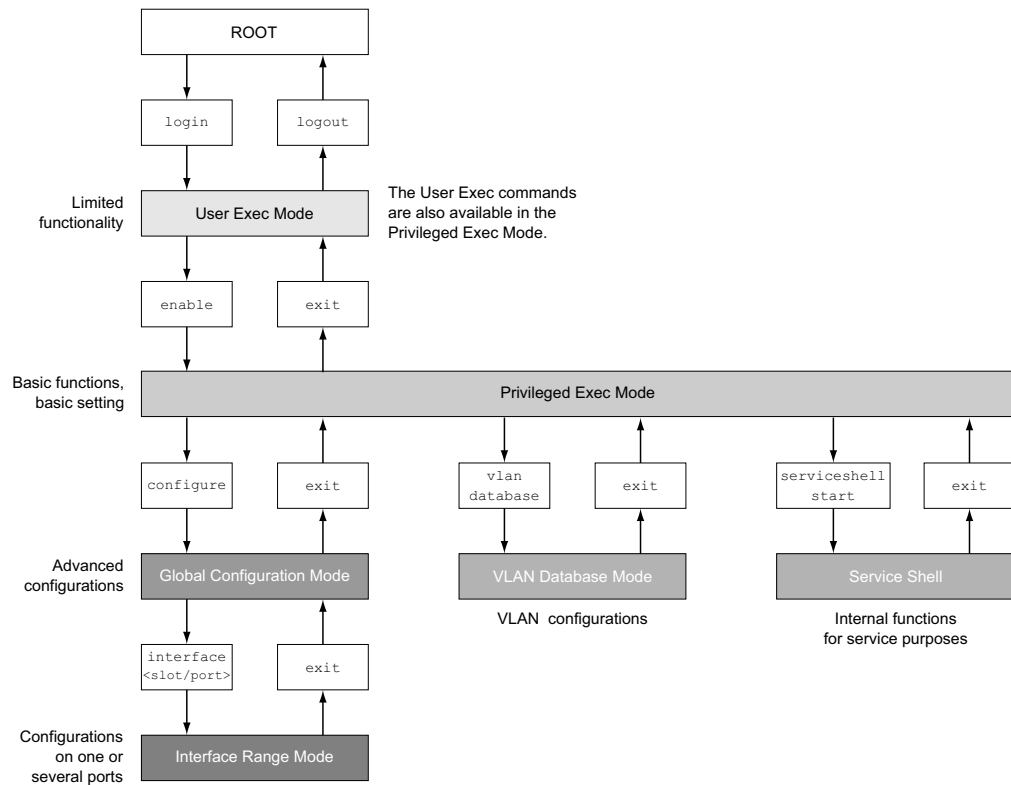

Figure 6: Structure of the Command Line Interface

The Command Line Interface supports, depending on the user level, the following modes:

- ▶ **User Exec mode**
When you log into the device management with the Command Line Interface, you are in the *User Exec* mode. The *User Exec* mode contains a limited range of commands.
Command prompt: (GRS) >
- ▶ **Privileged Exec mode**
To access the entire range of commands, you change to the *Privileged Exec* mode. The prerequisite for changing to the *Privileged Exec* mode is that you log into the device management as a privileged user. In the *Privileged Exec* mode, you are able to execute the *User Exec* mode commands, too.
Command prompt: (GRS) #
- ▶ **VLAN mode**
The VLAN mode contains VLAN-related commands.
Command prompt: (GRS) (VLAN)#
- ▶ **Service Shell**
The Service Shell is for service purposes only.
Command prompt: /mnt/fastpath #

- ▶ **Global Config** mode
The **Global Config** mode lets you perform modifications to the current configuration. This mode groups general setup commands.
Command prompt: (GRS) (config)#
- ▶ **Interface Range** mode
The commands in the **Interface Range** mode affect a specific port, a selected group of multiple ports or all port of the device. The commands modify a value or switch a function on/off on one or more specific ports.
 - All physical ports in the device
Command prompt: (GRS) ((interface) all)#
Example: When you switch from the **Global Config** mode to the **Interface Range** mode, the command prompt changes as follows:
(GRS) (config)#interface all
(GRS) ((Interface)all)#
 - A single port on one interface
Command prompt: (GRS) (interface <slot/port>)#
Example: When you switch from the **Global Config** mode to the **Interface Range** mode, the command prompt changes as follows:
(GRS) (config)#interface 2/1
(GRS) (interface 2/1)#
 - A range of ports on one interface
Command prompt: (GRS) (interface <interface range>)#
Example: When you switch from the **Global Config** mode to the **Interface Range** mode, the command prompt changes as follows:
(GRS) (config)#interface 1/2-1/4
(GRS) ((Interface)1/2-1/4)#
 - A list of single ports
Command prompt: (GRS) (interface <interface list>)#
Example: When you switch from the **Global Config** mode to the **Interface Range** mode, the command prompt changes as follows:
(GRS) (config)#interface 1/2,1/4,1/5
(GRS) ((Interface)1/2,1/4,1/5)#
 - A list of port ranges and single ports
Command prompt: (GRS) (interface <complex range>)#
Example: When you switch from the **Global Config** mode to the **Interface Range** mode, the command prompt changes as follows:
(GRS) (config)#interface 1/2-1/4,1/6-1/9
(GRS) ((Interface)1/2-1/4,1/6-1/9)

The following table displays the command modes, the command prompts (input request characters) visible in the corresponding mode, and the option with which you quit this mode.

Table 2: Command modes

Command mode	Access method	Quit or start next mode
<i>User Exec</i> mode	First access level. Perform basic tasks and list system information.	To quit you enter <code>logout</code> : (GRS) >logout Are you sure (Y/N) ?y
<i>Privileged Exec</i> mode	From the <i>User Exec</i> mode, you enter the command <code>enable</code> : (GRS) >enable (GRS) #	To quit the <i>Privileged Exec</i> mode and return to the <i>User Exec</i> mode, you enter <code>exit</code> : (GRS) #exit (GRS) >

Table 2: Command modes

Command mode	Access method	Quit or start next mode
VLAN mode	From the <i>Privileged Exec</i> mode, you enter the command <code>vlan database</code> : (GRS) #vlan database (GRS) (Vlan)#	To end the VLAN mode and return to the <i>Privileged Exec</i> mode, you enter <code>exit</code> or press <code><CTRL>+<Z></code> . (GRS) (Vlan)#exit (GRS) #
<i>Global Config</i> mode	From the <i>Privileged Exec</i> mode, you enter the command <code>configure</code> : (GRS) #configure (GRS) (config)# From the <i>User Exec</i> mode, you enter the command <code>enable</code> , and then in <i>Privileged Exec</i> mode, enter the command <code>Configure</code> : (GRS) >enable (GRS) #configure (GRS) (config)#	To quit the <i>Global Config</i> mode and return to the <i>Privileged Exec</i> mode, you enter <code>exit</code> : (GRS) (config)#exit (GRS) # To then quit the <i>Privileged Exec</i> mode and return to the <i>User Exec</i> mode, you enter <code>exit</code> again: (GRS) #exit (GRS) >
<i>Interface Range</i> mode	From the <i>Global Config</i> mode you enter the command <code>interface {all <slot/port> <interface range> <interface list> <complex range>}</code> . (GRS) (config)#interface <slot/port> (GRS) (interface slot/port)#	To quit the <i>Interface Range</i> mode and return to the <i>Global Config</i> mode, you enter <code>exit</code> . To return to the <i>Privileged Exec</i> mode, you press <code><CTRL>+<Z></code> . (GRS) (interface slot/port)#exit (GRS) #

When you enter a question mark (?) after the prompt, the Command Line Interface displays a list of the available commands and a short description of the commands.

```
(GRS)>
cli          Set the CLI preferences.
enable      Turn on privileged commands.
help        Display help for various special keys.
history     Show a list of previously run commands.
logout      Exit this session.
ping        Send ICMP echo packets to a specified IP address.
show        Display device options and settings.
telnet      Establish a telnet connection to a remote host.

(GRS)>
```

Figure 7: Commands in the User Exec mode

1.2.5 Executing the commands

Syntax analysis

When you log into the device management with the Command Line Interface, you are in the *User Exec* mode. The Command Line Interface displays the prompt (GRS)> on the screen.

When you enter a command and press the <Enter> key, the Command Line Interface starts the syntax analysis. The Command Line Interface searches the command tree for the desired command.

When the command is outside the Command Line Interface command range, a message informs you of the detected error.

Example:

You want to execute the `show system info` command, but enter `info` without `f` and press the <Enter> key.

The Command Line Interface then displays a message:

```
(GRS)>show system ino
```

```
Error: Invalid command 'ino'
```

Command tree

The commands in the Command Line Interface are organized in a tree structure. The commands, and where applicable the related parameters, branch down until the command is completely defined and therefore executable. The Command Line Interface checks the input. When you entered the command and the parameters correctly and completely, you execute the command with the <Enter> key.

After you entered the command and the required parameters, the other parameters entered are treated as optional parameters. When one of the parameters is unknown, the Command Line Interface displays a syntax message.

The command tree branches for the required parameters until the required parameters have reached the last branch in the structure.

With optional parameters, the command tree branches until the required parameters and the optional parameters have reached the last branch in the structure.

1.2.6 Structure of a command

This section describes the syntax, conventions and terminology, and uses examples to represent them.

Format of commands

Most of the commands include parameters.

When the command parameter is missing, the Command Line Interface informs you about the detection of an incorrect command syntax.

This manual displays the commands and parameters in the [Courier](#) font.

Parameters

The sequence of the parameters is relevant for the correct syntax of a command.

Parameters are required values, optional values, selections, or a combination of these things. The representation indicates the type of the parameter.

Table 3: *Parameter and command syntax*

<command>	Commands in pointed brackets (<>) are obligatory.
[command]	Commands in square brackets ([]) are optional.
<parameter>	Parameters in pointed brackets (<>) are obligatory.
[parameter]	Parameters in square brackets ([]) are optional.
...	An ellipsis (3 points in sequence without spaces) after an element indicates that you can repeat the element.
[Choice1 Choice2]	A vertical line enclosed in brackets indicates a selection option. Select one value. Elements separated by a vertical line and enclosed in square brackets indicate an optional selection (Option1 or Option2 or no selection).
{list}	Curved brackets ({}) indicate that a parameter is to be selected from a list of options.
{Choice1 Choice2}	Elements separated by a vertical line and enclosed in curved brackets ({}) indicate an obligatory selection option (option1 or option2).
[param1 {Choice1 Choice2}]	Displays an optional parameter that contains an obligatory selection.
<a.b.c.d>	Small letters are wild cards. You enter parameters with the notation a.b.c.d with decimal points (for example IP addresses)
<cr>	You press the <Enter> key to insert a line break (carriage return).

The following list displays the possible parameter values within the Command Line Interface:

Table 4: *Parameter values in the Command Line Interface*

Value	Description
IP address	This parameter represents a valid IPv4 address. The address consists of 4 decimal numbers with values from 0 to 255. The 4 decimal numbers are separated by a decimal point. The IP address 0.0.0.0 is a valid entry.
MAC address	This parameter represents a valid MAC address. The address consists of 6 hexadecimal numbers with values from 00 to FF. The numbers are separated by a colon, for example, 00:F6:29:B2:81:40 .
string	User-defined text with a length in the specified range, for example a maximum of 32 characters.

Table 4: Parameter values in the Command Line Interface

Value	Description
character string	Use double quotation marks to indicate a character string, for example “System name with space character”.
number	Whole integer in the specified range, for example 0..999999.
date	Date in format YYYY-MM-DD.
time	Time in format HH:MM:SS.

Network addresses

Network addresses are a requirement for establishing a data connection to a remote work station, a server, or another network. You distinguish between IP addresses and MAC addresses.

The IP address is an address allocated by the network administrator. The IP address is unique in one network area.

The MAC addresses are assigned by the hardware manufacturer. MAC addresses are unique worldwide.

The following table displays the representation and the range of the address types:

Table 5: Format and range of network addresses

Address Type	Format	Range	Example
IP address	nnn.nnn.nnn.nnn	nnn: 0 to 255 (decimal)	192.168.11.110
MAC address	mm:mm:mm:mm:mm:mm	mm: 00 to ff (hexadecimal number pairs)	A7:C9:89:DD:A9:B3

Strings

A string is indicated by quotation marks. For example, “System name with space character”. Space characters are not valid user-defined strings. You enter a space character in a parameter between quotation marks.

Example:

```
*(GRS)#cli prompt Device name  
Error: Invalid command 'name'
```

```
*(GRS)#cli prompt 'Device name'
```

```
*(Device name)#
```

1.2.7 Examples of commands

Example 1: clear arp-table-switch

Command for clearing the ARP table of the management agent (cache).

`clear arp-table-switch` is the command name. The command is executable without any other parameters by pressing the <Enter> key.

Example 2: radius server timeout

Command to specify the RADIUS server timeout value.

```
(GRS) (config)#radius server timeout  
<1..30>          Timeout in seconds (default: 5).
```

`radius server timeout` is the command name.

The parameter is required. The value range is `1..30`.

Example 3: radius server auth modify <1..8>

Command to set the parameters for RADIUS authentication server 1.

```
(GRS) (config)#radius server auth modify 1  
[name]          RADIUS authentication server name.  
[port]          RADIUS authentication server port.  
                (default: 1812).  
[msgauth]       Enable or disable the message authenticator  
                attribute for this server.  
[primary]       Configure the primary RADIUS server.  
[status]        Enable or disable a RADIUS authentication  
                server entry.  
[secret]        Configure the shared secret for the RADIUS  
                authentication server.  
[encrypted]     Configure the encrypted shared secret.  
<cr>           Press Enter to execute the command.
```

`radius server auth modify` is the command name.

The parameter `<1..8>` (RADIUS server index) is required. The value range is `1..8` (integer).

The parameters `[name]`, `[port]`, `[msgauth]`, `[primary]`, `[status]`, `[secret]` and `[encrypted]` are optional.

1.2.8 Input prompt

Command mode

With the input prompt, the Command Line Interface displays which of the three modes you are in:

- ▶ (GRS) >
User Exec mode
- ▶ (GRS) #
Privileged Exec mode
- ▶ (GRS) (config)#
Global Config mode
- ▶ (GRS) (Vlan)#
VLAN Database mode
- ▶ (GRS) ((Interface)all)#
Interface Range mode / All ports of the device
- ▶ (GRS) ((Interface)2/1)#
Interface Range mode / A single port on one interface
- ▶ (GRS) ((Interface)1/2-1/4)#
Interface Range mode / A range of ports on one interface
- ▶ (GRS) ((Interface)1/2,1/4,1/5)#
Interface Range mode / A list of single ports
- ▶ (GRS) ((Interface)1/1-1/2,1/4-1/6)#
Interface Range mode / A list of port ranges and single ports

Asterisk, pound sign and exclamation point

- ▶ Asterisk *
An asterisk * in the first or second position of the input prompt displays you that the settings in the volatile memory and the settings in the non-volatile memory are different. In your configuration, the device has detected modifications which have not been saved.
*(GRS)>
- ▶ Pound sign #
A pound sign # at the beginning of the input prompt displays you that the boot parameters and the parameters during the boot phase are different.
*(GRS)>
- ▶ Exclamation point !
An exclamation point ! at the beginning of the input prompt displays: the password for the `admin` user account corresponds with the default setting.
!(GRS)>

Wildcards

The device lets you change the command line prompt.

The Command Line Interface supports the following wildcards:

Table 6: Using wildcards within the Command Line Interface input prompt

Wildcard	Description
%d	System date
%t	System time

Table 6: Using wildcards within the Command Line Interface input prompt

Wildcard	Description
%i	IP address of the device
%m	MAC address of the device
%p	Product name of the device

```
!(GRS)>enable

!(GRS)#cli prompt %i

!192.168.1.5#cli prompt (GRS)%d

!*(GRS)2024-08-26#cli prompt (GRS)%d%t

!*(GRS)2024-08-26 19:50:37#cli prompt %m

!*AA:BB:CC:DD:EE:FF#
```

1.2.9 Key combinations

The following key combinations make it easier for you to work with the Command Line Interface:

Table 7: Key combinations in the Command Line Interface

Key combination	Description
<CTRL> + <H>, <Backspace>	Delete previous character
<CTRL> + <A>	Go to beginning of line
<CTRL> + <E>	Go to end of line
<CTRL> + <F>	Go forward one character
<CTRL> + 	Go backward one character
<CTRL> + <D>	Delete current character
<CTRL> + <U>, <X>	Delete to beginning of line
<CTRL> + <K>	Delete to end of line
<CTRL> + <W>	Delete previous word
<CTRL> + <P>	Go to previous line in history buffer
<CTRL> + <R>	Rewrite or paste the line
<CTRL> + <N>	Go to next line in history buffer
<CTRL> + <Z>	Return to root command prompt
<CTRL> + <G>	Aborts running tcpdump session
<Tab>, <SPACE>	Command line completion
Exit	Go to next lower command prompt
<?>	List choices

The Help command displays the possible key combinations in Command Line Interface on the screen:

```
(GRS) #help

HELP:
Special keys:

Ctrl-H, BkSp delete previous character
Ctrl-A .... go to beginning of line
Ctrl-E .... go to end of line
Ctrl-F .... go forward one character
Ctrl-B .... go backward one character
Ctrl-D .... delete current character
Ctrl-U, X .. delete to beginning of line
Ctrl-K .... delete to end of line
Ctrl-W .... delete previous word
Ctrl-P .... go to previous line in history buffer
Ctrl-R .... rewrites or pastes the line
Ctrl-N .... go to next line in history buffer
Ctrl-Z .... return to root command prompt
Ctrl-G .... aborts running tcpdump session
Tab, <SPACE> command-line completion
Exit .... go to next lower command prompt
? .... list choices

(GRS) #
```

Figure 8: Listing the key combinations with the Help command

1.2.10 Data entry elements

Command completion

To simplify typing commands, the Command Line Interface lets you use command completion (Tab Completion). Thus you are able to abbreviate key words.

- ▶ Type in the beginning of a keyword. When the characters entered identify a keyword, the Command Line Interface completes the keyword after you press the tab key or the space key. When there is more than one option for completion, enter the letter or the letters necessary for uniquely identifying the keyword. Press the tab key or the space key again. After that, the system completes the command or parameter.
- ▶ When you make a non-unique entry and press <Tab> or <Space> twice, the Command Line Interface provides you with a list of options.
- ▶ On a non-unique entry and pressing <Tab> or <Space>, the Command Line Interface completes the command up to the end of the uniqueness. When several commands exist and you press <Tab> or <Space> again, the Command Line Interface provides you with a list of options.

Example:

```
(GRS) (Config)#lo
(GRS) (Config)#log
logging logout
```

When you enter `lo` and <Tab> or <Space>, the Command Line Interface completes the command up to the end of the uniqueness to `log`.

When you press <Tab> or <Space> again, the Command Line Interface provides you with a list of options (`logging logout`).

Possible commands/parameters

You can obtain a list of the commands or the possible parameters by entering `help` or `?`, for example by entering `(GRS) >show ?`

When you enter the command displayed, you get a list of the parameters available for the command `show`.

When you enter the command without space character in front of the question mark, the device displays the help text for the command itself:

```
!*(GRS)(Config)#show?
```

```
show          Display device options and settings.
```

1.2.11 Use cases

Saving the Configuration

To help ensure that your password settings and your other configuration changes are kept after the device is reset or after an interruption of the voltage supply, you save the configuration. To do this, perform the following steps:

- Enter `enable` to change to the *Privileged Exec* mode.
- Enter the following command:
 `save [profile]`
- Execute the command by pressing the <Enter> key.

Syntax of the „radius server auth add“ command

Use this command to add a RADIUS authentication server.

- ▶ Mode: *Global Config* mode
- ▶ Privilege Level: *administrator*
- ▶ Format: `radius server auth add <1..8> ip <a.b.c.d> [name <string>] [port <1..65535>]`
 - `[name]`: RADIUS authentication server name.
 - `[port]`: RADIUS authentication server port (default value: `1813`).

Parameter	Meaning	Possible values
<1..8>	RADIUS server index.	1..8
<a.b.c.d>	RADIUS accounting server IP address.	IP address
<string>	Enter a user-defined text, max. 32 characters.	
<1..65535>	Enter port number between 1 and 65535.	1..65535

Mode and Privilege Level:

- ▶ Prerequisites for executing the command:
 - You are in the *Global Config* mode.
 See “[Mode-based command hierarchy](#)” on page 22.
 - You have the access role *administrator*.

Syntax of commands and parameters: See “[Structure of a command](#)” on page 26.

Examples for executable commands:

- ▶ `radius server auth add 1 ip 192.168.30.40`
- ▶ `radius server auth add 2 ip 192.168.40.50 name radiusserver2`
- ▶ `radius server auth add 3 ip 192.168.50.60 port 1813`
- ▶ `radius server auth add 4 ip 192.168.60.70 name radiusserver4 port 1814`

1.2.12 Service Shell

The Service Shell is for service purposes only.

The Service Shell lets users have access to internal functions of the device. When you need assistance with your device, the service personnel use the Service Shell to monitor internal conditions for example, the switch or CPU registers.

Do not execute internal functions without service technician instructions. Executing internal functions such as deleting the content of the non-volatile memory (NVM) **possibly leads to an inoperable device**.

Start the Service Shell

The prerequisite is that you are in *User Exec* mode: (GRS) >

Perform the following steps:

- Enter `enable` and press the <Enter> key.
To reduce the effort when typing:
 - Enter `e` and press the <Tab> key.
- Enter `serviceshell start` and press the <Enter> key.
To reduce the effort when typing:
 - Enter `ser` and press the <Tab> key.
 - Enter `s` and press the <Tab> key.

```
!GRS >enable
```

```
!*GRS #serviceshell start
```

```
WARNING! The service shell offers advanced diagnostics and functions.  
Proceed only when instructed by a service technician.
```

```
You can return to the previous mode using the 'exit' command.
```

```
BusyBox v1.31.0 (2024-08-26 19:50:37 UTC) built-in shell (ash)  
Enter 'help' for a list of built-in commands.
```

```
!/mnt/fastpath #
```

Working with the Service Shell

When the Service Shell is active, the timeout of the Command Line Interface is inactive. To help prevent configuration inconsistencies, end the Service Shell before any other user starts transferring a new configuration to the device.

Display the Service Shell commands

The prerequisite is that you already started the Service Shell.

Perform the following steps:

- Enter `help` and press the <Enter> key.

```
/mnt/fastpath # help
Built-in commands:
-----
. : [ [ alias bg break cd chdir command continue echo eval exec
exit export false fg getopts hash help history jobs kill let
local pwd read readonly return set shift source test times trap
true type ulimit umask unalias unset wait
/mnt/fastpath #
```

End the Service Shell

Perform the following steps:

- Enter `exit` and press the <Enter> key.

Deactivate the Service Shell permanently in the device

When you deactivate the Service Shell, you are still able to configure the device. However, you limit the possibilities of service personnel to perform system diagnostics. The service technician will no longer be able to access internal functions of your device.

The deactivation is irreversible. The Service Shell remains permanently deactivated. **To reactivate the Service Shell, the device requires disassembly by the manufacturer.**

The prerequisites are:

- The Service Shell is not started.
- You are in *User Exec mode*: (GRS) >

Perform the following steps:

- Enter `enable` and press the <Enter> key.
To reduce the effort when typing:
 - Enter `e` and press the <Tab> key.

- Enter `serviceshell deactivate` and press the <Enter> key.
To reduce the effort when typing:
 - Enter `ser` and press the <Tab> key.
 - Enter `dea` and press the <Tab> key.
 - This step is irreversible!**
Press the <Y> key.
-

```
!GRS >enable
```

```
!*GRS #serviceshell deactivate
```

```
Notice: If you continue, then the Service Shell is permanently deactivated.
```

```
This step is irreversible!
```

```
For details, refer to the Configuration Manual.
```

```
Are you sure (Y/N) ?
```

1.3 System monitor

The System Monitor lets you set basic operating parameters before starting the operating system.

1.3.1 Functional scope

In the System Monitor, you carry out the following tasks, for example:

- ▶ Managing the operating system and verifying the device software image
- ▶ Starting the operating system
- ▶ Deleting configuration profiles, resetting the device to the factory settings
- ▶ Checking boot code information

1.3.2 Starting the System Monitor

You establish a serial connection to the device using the USB-C interface. During the system startup, the serial interface of the device is unavailable. For this reason, starting the System Monitor works differently from other Hirschmann devices. To start the System Monitor, you set the device to the Recovery Mode.

Set the device to the Recovery Mode

Required accessories:

- ▶ External memory (recommended: ACA31)
- ▶ Computer with VT100 terminal emulation (for example PuTTY) or a serial terminal

Perform the following steps:

- Plug the external memory into your computer.
- In the root directory of the external memory, add an empty file named `recovery.txt`.
- Plug the external memory into the device.
- Restart the device.
- Observe the LEDs while the device boots. When the *Status* LED flashes alternately red and green, the device has successfully booted into the Recovery Mode.

Note: You find the description of the display elements in the “Installation” user manual.

Access the System Monitor

Perform the following steps:

- Remove the external memory from the device.
- Connect your computer to the device using the USB cable.
- Open the VT100 terminal emulation on the computer to display the System Monitor.
- Select the appropriate COM port.

When the computer and the device are successfully connected, you see a black screen.

Perform the following steps:

- Press the <Enter> key to display the System Monitor.
You see the following view on your computer:

```
System Monitor 1
(Selected OS: ...-10.0 (2024-08-24 16:39))

1 Manage operating system
3 Start selected operating system
4 Manage configurations
5 Show boot code information
q End (reset and reboot)

sysMon1>
```

Figure 9: *System Monitor 1 view*

- To select a menu item, enter the corresponding number.
- To leave a submenu and return to the main menu, press the <ESC> key.

Note: To boot the device normally next time, only add the external memory without the recovery.txt file.

2 Specifying the IP parameters

When you install the device for the first time, specify the IP parameters.

The device provides the following options for entering the IP parameters during the first installation:

- ▶ Entry using the Command Line Interface.
When you preconfigure your device outside its operating environment, or restore the network access (“In-Band”) to the device, choose this “Out-of-Band” method.
- ▶ Entry using the HiDiscovery protocol.
When you have a previously installed network device or you have another Ethernet connection between your PC and the device, you choose this “In-Band” method.
- ▶ Configuration using the external memory.
When you are replacing a device with a device of the same type and have already saved the configuration in the external memory, you choose this method.
- ▶ Using BOOTP.
To set up the installed device to use BOOTP, you choose this In-Band method. You need a BOOTP server for this method. The BOOTP server assigns the configuration data to the device using the MAC address of the device. The DHCP mode is the default mode for the configuration data reference.
- ▶ Configuration using DHCP.
To set up the installed device to use DHCP, you choose this In-Band method. You need a DHCP server for this method. The DHCP server assigns the configuration data to the device using the MAC address or the system name of the device.
- ▶ Configuration using the Graphical User Interface.
When the device already has an IP address and is reachable using the network, the Graphical User Interface provides you with another option for configuring the IP parameters.

2.1 IP parameter basics

2.1.1 IPv4

IP address

The IP addresses consist of 4 bytes. Write these 4 bytes in decimal notation, separated by a decimal point.

RFC 1340 written in 1992, defines 5 IP address classes.

Table 8: IP address classes

Class	Network address	Host address	Address range
A	1 Byte	3 Bytes	0.0.0.0..127.255.255.255
B	2 Bytes	2 Bytes	128.0.0.0..191.255.255.255
C	3 Bytes	1 Byte	192.0.0.0..223.255.255.255
D			224.0.0.0..239.255.255.255
E			240.0.0.0..255.255.255.255

The first byte of an IP address is the network address. The worldwide leading regulatory board for assigning network addresses is the Internet Assigned Numbers Authority (IANA). When you require an IP address block, contact your Internet Service Provider (ISP). Your ISP contacts their local higher-level organization to reserve an IP address block:

- ▶ APNIC (Asia Pacific Network Information Center)
Asia/Pacific Region
- ▶ ARIN (American Registry for Internet Numbers)
Americas and Sub-Sahara Africa
- ▶ LACNIC (Regional Latin-American and Caribbean IP Address Registry)
Latin America and some Caribbean Islands
- ▶ RIPE NCC (Réseaux IP Européens)
Europe and Surrounding Regions

0	Net ID - 7 bits	Host ID - 24 bits	Class A		
1	0	Net ID - 14 bits	Host ID - 16 bits	Class B	
1	1	0	Net ID - 21 bits	Host ID - 8 bits	Class C
1	1	1	0	Multicast Group ID - 28 bits	Class D
1	1	1	1	reserved for future use - 28 bits	Class E

Figure 10: Bit representation of the IP address

When the first bit of an IP address is 0, it belongs to class A. The first octet is less than 128.

When the first bit of an IP address is 1 and the second bit is 0, it belongs to class B. The first octet is between 128 and 191.

When the first 2 bits of an IP address are 1, it belongs to class C. The first octet is higher than 191.

Assigning the address of the host (*Host ID*) is the responsibility of the network operator. The network operator alone is responsible for the uniqueness of the assigned IP addresses.

Netmask

Routers and *Gateways* subdivide large networks into subnets. The netmask assigns the IP addresses of the individual devices to a particular subnet.

You perform subnet division using the netmask in much the same way as the division of the network addresses (net id) into classes A to C.

Set the bits of the host address (host id) that represent the mask to one. Set the remaining host address bits to zero (see the following examples).

Example of a subnet mask:

Decimal notation
255.255.192.0

Binary notation
11111111.11111111.11000000.00000000

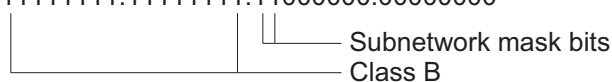

Example of applying the subnet mask to IP addresses for subnet assignment:

Decimal notation

129.218.65.17

└─── 128 < 129 191 > Class B

Binary notation

10000001.11011010.01000001.00010001

└─── Subnetwork 1
└─── Network address

Decimal notation

129.218.129.17

└─── 128 < 129 191 > Class B

Binary notation

10000001.11011010.10000001.00010001

└─── Subnetwork 2
└─── Network address

How to use the netmask

In a large network it is possible that *Gateways* and routers separate the management agent from its network management station. How does addressing work in such a case?

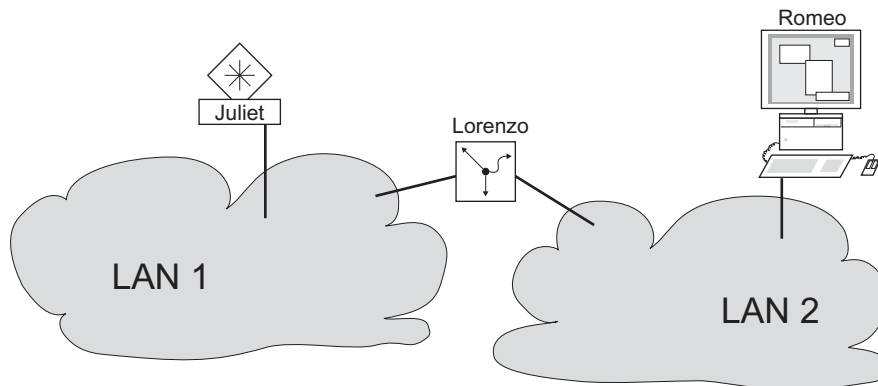

Figure 11: The management agent is separated from its network management station by a router

The network management station “Romeo” wants to send data to the management agent “Juliet”. Romeo knows Juliet’s IP address and also knows that the router “Lorenzo” knows the way to Juliet.

Romeo therefore puts his message in an envelope and writes Juliet’s IP address as the destination address; for the source address he writes his own IP address on the envelope.

Romeo then places this envelope in a second one with Lorenzo’s MAC address as the destination and his own MAC address as the source. This process is comparable to going from Layer 3 to Layer 2 of the ISO/OSI base reference model.

Finally, Romeo puts the entire data packet into the mailbox which is comparable to going from Layer 2 to Layer 1, that means to sending the data packet over the Ethernet.

Lorenzo receives the letter, removes the outer envelope and recognizes from the inner envelope that the letter is meant for Juliet. He places the inner envelope in a new outer envelope and searches his address list (the ARP table) for Juliet's MAC address; he writes her MAC address on the outer envelope as the destination address and his own MAC address as the source address. He then places the entire data packet in the mail box.

Juliet receives the letter and removes the outer envelope. She finds the inner envelope with Romeo's IP address. Opening the inner envelope and reading its contents corresponds to transferring the message to the higher protocol layers of the ISO/OSI layer model.

Juliet would now like to send a reply to Romeo. She places her reply in an envelope with Romeo's IP address as destination and her own IP address as source. But where is she to send the answer? For she did not receive Romeo's MAC address. It was lost, because Lorenzo replaced the outer envelope.

In the MIB, Juliet finds Lorenzo listed under the variable `hmNetGatewayIPAddr` as a means of communicating with Romeo. She therefore puts the envelope with the IP addresses in a further envelope with Lorenzo's MAC destination address.

The letter now travels back to Romeo through Lorenzo, the same way the first letter traveled from Romeo to Juliet.

Classless Inter-Domain Routing

Class C with a maximum of 254 (2^8-2) addresses was too small, and class B with a maximum of 65534 ($2^{16}-2$) addresses was too large for most users, resulting in an ineffective usage of the available class B addresses.

Class D contains reserved Multicast addresses. Class E is for experimental purposes. A non-participating *Gateway* ignores experimental datagrams with these destination addresses.

Since 1993, RFC 1519 has been using Classless Inter-Domain Routing (CIDR) to provide a solution. CIDR overcomes these class boundaries and supports classless address ranges.

With CIDR, you specify the number of bits that designate the IP address range. You represent the IP address range in binary form and count the mask bits that designate the netmask. The mask bits equal the number of bits used for the subnet in a given IP address range.

Example:

IP address, decimal	Network mask, decimal	IP address, binary
192.168.112.1	255.255.255.128	11000000 10101000 01110000 00000001
192.168.112.127		11000000 10101000 01110000 01111111
		----- 25 mask bits -----
CIDR notation: 192.168.112.0/25		
		└----- Mask bits

The term "supernetting" refers to combining a number of class C address ranges. Supernetting lets you subdivide class B address ranges to a fine degree.

2.1.2 IPv6

IP parameter basics

The Internet Protocol version 6 (IPv6) is the new version of the Internet Protocol version 4 (IPv4). The need to implement IPv6 was due to the fact that IPv4 addresses are not sufficient in the context of the growing Internet today. The IPv6 protocol is described in RFC 8200.

Some of the differences between IPv6 and IPv4 are:

- ▶ Address representation and length
- ▶ Absence of the broadcast address type
- ▶ Simplified header structure
- ▶ Fragmentation performed only by the source host
- ▶ Added capabilities for packet flow identification in the network

Both IPv4 and IPv6 protocols can operate at the same time in the device. This is possible with the use of the Dual IP Layer technique, also referred to as Dual Stack.

Note: If you want the device to operate only using the IPv4 function, then disable the IPv6 function in the device.

In the device, the IPv6 protocol has the following restrictions:

- ▶ You can specify a maximum number of 8 IPv6 unicast addresses as follows:
 - 4 IPv6 addresses using manual configuration
 - 2 IPv6 addresses when the *Auto* radio button is selected
 - 1 IPv6 address using the DHCPv6 server
 - 1 link-local address
- ▶ The IPv6 function can be enabled only on the management interface. The total number of configurable IPv6 addresses can be used at the same time on the interface.
- ▶ The IPv6 addresses can be used to set the management IP address of the device. Other services where IPv6 addresses can be used include for example, SNMP, SYSLOG, DNS, and LDAP.

Address representation

The IPv6 address consists of 128 bits. It is represented as 8 groups of 4 hexadecimal digits, each group representing 16 bits, further referred to as a hextet. The hextets are separated by colons (:). IPv6 addresses are not case-sensitive and you can write them in either lowercase or uppercase.

In accordance with RFC 4291, the preferred format for an IPv6 address is x:x:x:x:x:x:x. Each “x” consists of 4 hexadecimal values and represents a hextet. An example of a preferred format of an IPv6 address is shown in the figure below.

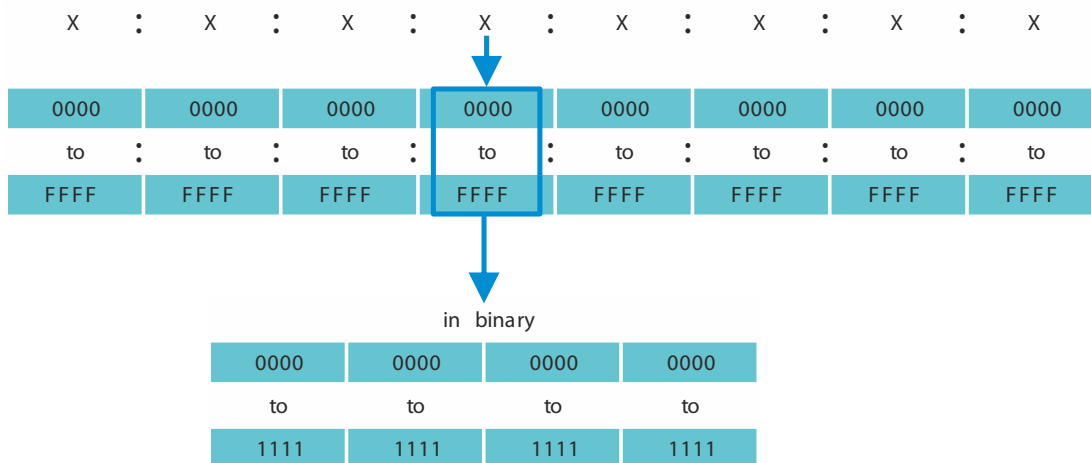

Figure 12: IPv6 address representation

As you can see in the figure above, usually an IPv6 address contains many zeros. To shorten IPv6 addresses that contain 0 bits, it is necessary to follow 2 writing rules:

- ▶ The first rule is to discard the leading zeros in every hextet. This rule is only applied to leading zeros and not to the trailing zeros of a hextet. If the trailing zeros are also discarded, then the resulting address is ambiguous.
- ▶ The second rule uses a special syntax to compress the zeros. You can use 2 adjacent colons “::” to replace a string of adjacent hextets that contain only zeros. The “::” sign can be used only one time in an address. If the “::” sign is used more than one time in an address representation, then there can be more than one possible address expanded from that notation.

When the two rules are applied, the result is commonly known as the compressed format.

In the table below you can find 2 examples of how these rules are applied:

Table 9: IPv6 address compression

Preferred	CC03:0000:0000:0000:0001:AB30:0400:FF02
No leading zeros	CC03: 0: 0: 0: 1:AB30: 400:FF02
Compressed	CC03::1:AB30:400:FF02
Preferred	2008:00B7:0000:DEF0:DDDD:0000:E604:0001
No leading zeros	2008: B7: 0:DEF0:DDDD: 0:E604: 1
Compressed	2008:B7::DEF0:DDDD:0:E604:1

Prefix length

Unlike an IPv4 address, an IPv6 address does not use a subnet mask to identify the subnet part of the address. Instead, the IPv6 protocol uses the prefix length.

The text representation of IPv6 address prefixes is similar to the way IPv4 address prefixes are written in Classless Inter-Domain Routing (CIDR):

`<ipv6-address>/<prefix-length>`

The prefix length range is `0..128`. The typical IPv6 prefix length for LANs and other types of networks is `/64`. This means that the network portion of the address is 64 bits in length. The remaining 64 bits represent the Interface ID, similar to the host portion of the IPv4 address.

In the figure below you can find an example of prefix length bits allocation.

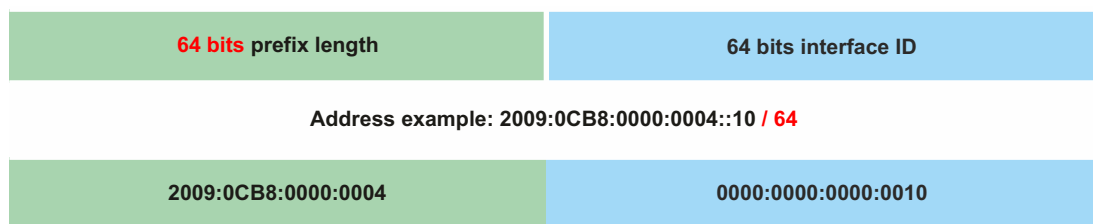

Address types

The IPv6 address types are described in RFC 4291.

The IPv6 address types are identified by the high-order bits of the address, as in the table below:

Table 10: IPv6 address types

Address type	Binary prefix	IPv6 notation
Unspecified	00...0 (128 bits)	::/128
Loopback	00...1 (128 bits)	::1/128
Multicast	11111111	FF00::/8
Link-local Unicast	1111111010	FE80::/10
Global Unicast	(everything else)	

Unspecified address

The IPv6 address with every bit set to 0 is called the Unspecified address, which corresponds to 0.0.0.0 in IPv4. The Unspecified address is used only to indicate the absence of an address. It is typically used as a source address when a unique address is not determined yet.

Note: The Unspecified address cannot be assigned to an interface or used as a destination address.

Loopback address

The unicast address 0:0:0:0:0:0:1 is called the Loopback address. The Loopback address can be used by a device to send an IPv6 packet to itself. The Loopback address cannot be assigned to a physical interface.

Multicast address

IPv6 does not have a broadcast address like IPv4. But there is an IPv6 all-nodes Multicast address that essentially gives the same result.

An IPv6 Multicast address is used to send an IPv6 packet to multiple destinations. The structure of a Multicast address is as follows: The next 4 bits identify the scope of the Multicast address (how far the packet is transmitted):

- ▶ The first 8 bits are set to FF.
- ▶ The next 4 bits are the lifetime of the address: 0 is permanent and 1 is temporary.
- ▶ The next 4 bits identify the scope of the Multicast address, meaning how far the packets are transmitted through the network.

Link-Local address

The Link-Local address is used to communicate with other devices on the same link. The term “link” refers to a subnet. Routers do not forward packets with link-local source or destination addresses to other links.

Link-local addresses are used to transmit packets on a single link for scopes such as automatic address configuration, neighbor discovery, or when no routers are present. They have the following format:

Table 11: Link-Local Address format

10 bits	54 bits	64 bits
1111111010	0	Interface ID

The Link-Local address is specified and cannot be changed.

Global Unicast address

A Global Unicast address is globally unique and can be routed over the Internet. This type of addresses are equivalent to public IPv4 addresses. Currently, only Global Unicast addresses with the first three bits of 001 or 2000::/3 are assigned.

A Global Unicast address has 3 parts:

- ▶ Global Routing Prefix
- ▶ Subnet ID
- ▶ Interface ID

The Global Routing Prefix is the network portion of the address.

The Subnet ID is used by an organization to identify its subnets and it has up to 16 bits in length. The length of the Subnet ID is given by the length of the Global Routing Prefix.

The Interface ID identifies an interface of a particular node. The term Interface ID is used because one host can have multiple interfaces, each having one or more IPv6 addresses.

The general format for IPv6 Global Unicast addresses is represented in the figure below.

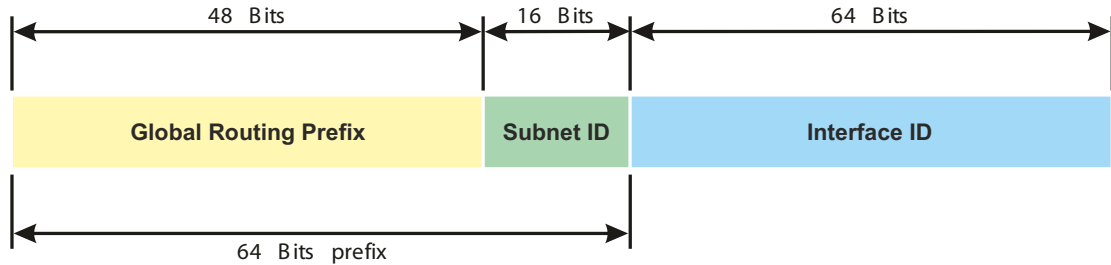

Figure 13: IPv6 Global Unicast address general format

2.2 Specifying the IP parameters using the Command Line Interface

2.2.1 IPv4

There are the following methods you enter the IP parameters:

- ▶ BOOTP/DHCP
- ▶ HiDiscovery protocol
- ▶ External memory
- ▶ Command Line Interface using the serial connection

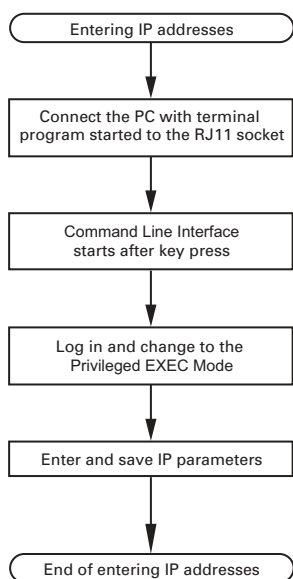

Figure 14: Flow chart for entering IP addresses

Note: If a terminal or PC with terminal emulation is unavailable in the vicinity of the installation location, you can set up the device at your own workstation, then take it to its final installation location.

Perform the following steps:

- Set up a connection to the device.
The start screen appears.

```
NOTE: Enter '?' for Command Help. Command help displays all opt
that are valid for the particular mode.
For the syntax of a particular command form, please
consult the documentation.

! ( )>
```

- Deactivate DHCP.

- Enter the IP parameters.
 - ▶ Local IP address
In the default setting, the local IP address is 0.0.0.0.
 - ▶ Netmask
When you divided the network into subnets, and these are identified with a netmask, enter the netmask here. In the default setting, the local netmask is 0.0.0.0.
 - ▶ IP address of the gateway.
This entry is only required in cases where the device and the network management station or TFTP server are located in different subnets (see on page 43 “How to use the netmask”). Specify the IP address of the gateway between the subnet with the device and the path to the network management station.
In the default setting, the IP address is 0.0.0.0.
- Save the configuration specified using `copy config running-config nvram`.

<pre>enable network protocol none network parms 10.0.1.23 255.255.255.0 copy config running-config nvram</pre>	<p>To change to the Privileged EXEC mode.</p> <p>To deactivate DHCP.</p> <p>To assign the device the IP address 10.0.1.23 and the netmask 255.255.255.0. You have the option of also assigning a <i>Gateway</i> address.</p> <p>To save the current settings in the non-volatile memory (<i>nvram</i>) in the “Selected” configuration profile.</p>
--	---

After entering the IP parameters, you easily set up the device using the Graphical User Interface.

2.2.2

IPv6

The device lets you specify the IPv6 parameters using the Command Line Interface over the serial interface. Another option to access the Command Line Interface is using a SSH connection with the use of the IPv4 management address.

Perform the following steps:

- Set up a connection to the device.
The start screen appears.

```
NOTE: Enter '?' for Command Help. Command help displays all opt
that are valid for the particular mode.
For the syntax of a particular command form, please
consult the documentation.

! ( ) >
```

- Enable the IPv6 protocol if the protocol is disabled.
- Enter the IPv6 parameters.
 - ▶ IPv6 address
Valid IPv6 address. The IPv6 address is displayed in a compressed format.
 - ▶ Prefix length
Unlike an IPv4 address, an IPv6 address does not use a subnet mask to identify the subnet part of the address. This role is performed in IPv6 by the prefix length (see on page 47 “Prefix length”).

- ▶ *EUI option* function
 You can use the *EUI option* function to automatically specify the Interface ID of the IPv6 address. The device uses the MAC address of its interface with the values `ff` and `fe` added between byte 3 and byte 4 to generate a 64 bit Interface ID.
 You can only select this option for IPv6 addresses that have a prefix length equal to `64`.
- ▶ IPv6 Gateway address
 The IPv6 Gateway address is the address of a router through which the device accesses other devices outside its own network.
 You can specify any IPv6 address except loopback and Multicast addresses.
 In the default setting, the IPv6 Gateway address is `::`.

<code>enable</code>	To change to the Privileged EXEC mode.
<code>network ipv6 operation</code>	To enable the IPv6 protocol if the protocol is disabled. In the default setting, the IPv6 protocol is enabled.
<code>network ipv6 address add 2001::1 64 eui-64</code>	To assign the IPv6 address <code>2001::1</code> and the prefix length <code>64</code> . The <code>eui-64</code> parameter is optional. You have the option of also assigning a Gateway address.
<code>copy config running-config nvm</code>	To save the current settings in the non-volatile memory (<code>nvm</code>) in the “Selected” configuration profile.

After entering the IPv6 parameters, you easily set up the device using the Graphical User Interface. To use an IPv6 address in a URL, use the following URL syntax: `https://[<ipv6_address>]`.

2.3 Specifying the IP parameters using HiDiscovery

The HiDiscovery protocol lets you assign IP parameters to the device using the Ethernet.

You easily set up other parameters using the Graphical User Interface.

Perform the following steps:

- Install the HiDiscovery program on your computer.
- Start the HiDiscovery program.

Id	MAC Address	Writable	IP Address	Net Mask	Default Gateway	Product	Name
1	00:80:63:A4:CC:00	<input checked="" type="checkbox"/>	10.115.0.76	255.255.224.0	10.115.0.3		
2	00:80:63:C0:50:00	<input type="checkbox"/>	10.115.0.33	255.255.224.0	10.115.0.3		
3	00:80:63:A3:40:00	<input type="checkbox"/>	10.115.0.70	255.255.224.0	10.115.0.3		
4	00:80:63:98:14:00	<input type="checkbox"/>	10.115.0.17	255.255.224.0	10.115.0.3		
5	00:80:63:96:E4:00	<input type="checkbox"/>	0.0.0.0	0.0.0.0	0.0.0.0		
6	00:80:63:46:00:06	<input checked="" type="checkbox"/>	192.168.2.181	255.255.255.0	192.168.2.1		
7	00:80:63:A3:40:40	<input type="checkbox"/>	10.115.0.59	255.255.224.0	10.115.0.3		
8	00:80:63:A4:CC:40	<input type="checkbox"/>	10.115.0.81	255.255.224.0	10.115.0.3		
9	00:80:63:6E:38:4E	<input checked="" type="checkbox"/>	192.168.2.174	255.255.255.0	192.168.2.1		
10	00:80:63:18:2A:61	<input checked="" type="checkbox"/>	192.168.2.170	255.255.255.0	192.168.2.1		
11	00:80:63:A3:40:80	<input type="checkbox"/>	10.115.0.66	255.255.224.0	10.115.0.3		
12	00:80:63:A4:CC:80	<input type="checkbox"/>	10.115.0.80	255.255.224.0	10.115.0.3		
13	00:80:63:61:AC:81	<input checked="" type="checkbox"/>	192.168.2.176	255.255.255.0	192.168.2.1		
14	00:80:63:98:10:95	<input type="checkbox"/>	10.115.0.22	255.255.224.0	10.115.0.3		
15	00:80:63:61:AC:AB	<input checked="" type="checkbox"/>	192.168.2.40	255.255.255.0	192.168.2.1		
16	00:80:63:3B:5C:BD	<input checked="" type="checkbox"/>	192.168.2.178	255.255.255.0	192.168.2.1		
17	00:80:63:A3:40:C0	<input type="checkbox"/>	10.115.0.72	255.255.224.0	10.115.0.3		
18	00:80:63:8F:2C:BE	<input type="checkbox"/>	10.115.0.40	255.255.224.0	10.115.0.3		
19	00:80:63:88:38:EC	<input checked="" type="checkbox"/>	192.168.110.92	255.255.255.0	0.0.0.0		
20	00:80:63:9B:11:00	<input type="checkbox"/>	10.115.0.35	255.255.224.0	10.115.0.3		
21	00:80:63:A4:CD:00	<input type="checkbox"/>	10.115.0.77	255.255.224.0	10.115.0.3		
22	00:80:63:99:41:08	<input type="checkbox"/>	10.115.0.13	255.255.224.0	10.115.0.3		
23	00:80:63:17:35:08	<input checked="" type="checkbox"/>	192.168.2.164	255.255.255.0	192.168.2.1		
24	00:80:63:44:19:2E	<input checked="" type="checkbox"/>	10.115.5.130	255.255.224.0	10.115.0.3		

Figure 15: HiDiscovery

When HiDiscovery is started, HiDiscovery automatically searches the network for those devices which support the HiDiscovery protocol.

HiDiscovery uses the first network interface found for the PC. When your computer has several network interfaces, you can select the desired network interface in the HiDiscovery toolbar.

HiDiscovery displays a line for every device that responds to a HiDiscovery protocol inquiry.

HiDiscovery lets you identify the devices displayed.

- Select a device line.
- To set the LEDs to flashing for the selected device, click the *Signal* button on the tool bar. To stop the flashing, click the *Signal* button again.
- By double-clicking a line, you open a window in which you specify the device name and the IP parameter.

Properties

MAC Address: 00:80:63:A3:40:00

Name: Power Unit 1 Switch 2

IP Configuration

IP Address: 10 . 115 . 0 . 70 Set Default ()

Net Mask: 255 . 255 . 224 . 0 Set Default ()

Default Gateway: 10 . 115 . 0 . 3 Set Default ()

Save As Default

Ok Cancel

Figure 16: HiDiscovery – assigning IP parameters

Note: Disable the HiDiscovery function in the device, after you have assigned the IP parameters to the device.

Note: Save the settings so that you will still have the entries after a restart.

2.4 Specifying the IP parameters using the Graphical User Interface

2.4.1 IPv4

Perform the following steps:

- Open the *Basic Settings > Network > Global* dialog.

In this dialog, you specify the VLAN in which the device management can be accessed and set up the HiDiscovery access.

- In the *VLAN ID* column you specify the VLAN in which the device management can be accessed over the network.

Note here that you can only access the device management using ports that are members of the relevant VLAN.

The *MAC address* field displays the MAC address of the device with which you access the device over the network.

- In the *HiDiscovery protocol v1/v2* frame you specify the settings for accessing the device using the HiDiscovery software.
- The HiDiscovery protocol lets you allocate an IP address to the device on the basis of its MAC address. Activate the HiDiscovery protocol if you want to allocate an IP address to the device from your PC with the HiDiscovery software.
- Open the *Basic Settings > Network > IPv4* dialog.

In this dialog, you specify the source from which the device gets its IP parameters after starting.

- In the *Management interface* frame you first specify where the device gets its IP parameters from:
 - ▶ In the *BOOTP* mode, the configuration is using a BOOTP or DHCP server on the basis of the MAC address of the device.
 - ▶ In the *DHCP* mode, the configuration is using a DHCP server on the basis of the MAC address or the name of the device.
 - ▶ In the *Local* mode, the device uses the network parameters from the internal device memory.

Note: When you change the allocation mode of the IP address, the device activates the new mode immediately after you click the button.

- If required, you enter the IP address, the netmask and the *Gateway* in the *IP parameter* frame.
- Apply the settings temporarily. To do this, click the button.

2.4.2 IPv6

Perform the following steps:

- Open the [Basic Settings > Network > IPv6](#) dialog.
- The IPv6 protocol is enabled by default. Verify if the *On* radio button is selected in the [Operation](#) frame.
- In the [Configuration](#) frame you specify where the device gets its IPv6 parameters from:
 - ▶ If the *None* radio button is selected, then the device receives its IPv6 parameters manually. You can manually specify a maximum number of 4 IPv6 addresses. You cannot specify loopback, link-local, and Multicast addresses as static IPv6 addresses.
 - ▶ If the *Auto* radio button is selected, then the device receives its IPv6 parameters dynamically for example, with the use of a Router Advertisement Daemon (radvd). The device receives a maximum of 2 IPv6 addresses.
 - ▶ If the *DHCPv6* radio button is selected, then the device receives its IPv6 parameters from a DHCPv6 server. The device can receive only one IPv6 address from the DHCPv6 server.
 - ▶ If the *All* radio button is selected, then the device receives its IPv6 parameters using every alternative for both dynamic and manual assignments.

Note: When you change the allocation mode of the IPv6 address, the device activates the new mode immediately after you click the  button.

- If necessary, you enter the [Gateway address](#) in the [IP parameter](#) frame.

Note: If the *Auto* radio button is selected and you use a Router Advertisement Daemon (radvd), then the device automatically receives a link-local type [Gateway address](#) with a higher metric than the manually set [Gateway address](#).

- In the [Duplicate Address Detection](#) frame you can specify the number of consecutive [Neighbor Solicitation](#) messages that the device sends for the [Duplicate Address Detection](#) function (see on page 62 “[Duplicate Address Detection](#) function”).

Apply the settings temporarily. To do this, click the  button.

Manually specify an IPv6 address. To do this, perform the following steps:

- Open the [Basic Settings > Network > IPv6](#) dialog.
- Click the  button.
The dialog displays the [Create](#) window.
 - Enter the IPv6 address in the [IP address](#) field.
 - Enter the IPv6 address prefix length in the [PrefixLength](#) field.
 - Click the [Ok](#) button.
The device adds a table row.

2.5 Specifying the IP parameters using BOOTP

With the *BOOTP* function activated the device sends a boot request message to the BOOTP server. The boot request message contains the Client ID specified in the *Basic Settings > Network > IPv4* dialog. The BOOTP server enters the Client ID into a database and assigns an IP address. The server answers with a boot reply message. The boot reply message contains the assigned IP address.

2.6 Specifying the IP parameters using DHCP

2.6.1 IPv4

The Dynamic Host Configuration Protocol (DHCP) is a further development of BOOTP, which it has replaced. The DHCP additionally lets the configuration of a DHCP client using a name instead of using the MAC address.

For the DHCP, this name is known as the *Client Identifier* in accordance with RFC 2131.

The device uses the name entered under *sysName* in the system group of the MIB II as the *Client Identifier*. You can change the system name using the Graphical User Interface (see dialog [Basic Settings > System](#)), the Command Line Interface or SNMP.

The device sends its system name to the DHCP server. The DHCP server then uses the system name to allocate an IP address as an alternative to the MAC address.

In addition to the IP address, the DHCP server sends

- ▶ the netmask
- ▶ the default *Gateway* (if available)
- ▶ the TFTP URL of the configuration file (if available).

The device applies the configuration data to the appropriate parameters. When the DHCP Server assigns the IP address, the device permanently saves the configuration data in non-volatile memory.

Table 12: DHCP options which the device requests

Options	Meaning
1	Subnet Mask
2	Time Offset
3	Router
4	Time server
12	Hostname
42	NTP server
61	Client Identifier
66	TFTP Server Name
67	Bootfile Name

The advantage of using DHCP instead of BOOTP is that the DHCP server can restrict the validity of the configuration parameters (“Lease”) to a specific time period (known as dynamic address allocation). Before this period (“Lease Duration”) elapses, the DHCP client can attempt to renew this lease. As an alternative, the client can negotiate a new lease. The DHCP server then allocates a random free address.

To help avoid this, DHCP servers provide the explicit configuration option of assigning a specific client the same IP address based on a unique hardware ID (known as static address assignment).

In the default setting, DHCP is activated. As long as DHCP is active, the device attempts to obtain an IP address. When the device cannot find a DHCP server after restarting, it will not have an IP address. The [Basic Settings > Network > IPv4](#) dialog lets you activate or deactivate DHCP.

Note: When using Industrial HiVision network management, verify that DHCP allocates the original IP address to every device.

The appendix contains an example configuration of the BOOTP/DHCP-server.

Example of a DHCP-configuration file:

```
# /etc/dhcpd.conf for DHCP Daemon
#
subnet 10.1.112.0 netmask 255.255.240.0 {
option subnet-mask 255.255.240.0;
option routers 10.1.112.96;
}
#
# Host berta requests IP configuration
# with her MAC address
#
host berta {
hardware ethernet 00:80:63:08:65:42;
fixed-address 10.1.112.82;
}
#
# Host hugo requests IP configuration
# with his client identifier.
#
host hugo {
#
option dhcp-client-identifier "hugo";
option dhcp-client-identifier 00:68:75:67:6f;
fixed-address 10.1.112.83;
server-name "10.1.112.11";
filename "/agent/config.dat";
}
}
```

Lines beginning with the # character, contain comments.

The lines preceding the individually listed devices refer to settings that apply to the following device.

The fixed-address line assigns a permanent IP address to the device.

For further information, see the DHCP server manual.

2.6.2 IPv6

The Dynamic Host Configuration Protocol version 6 (DHCPv6) is a network protocol that is used to dynamically specify IPv6 addresses. This protocol is the IPv6 equivalent of the Dynamic Host Configuration Protocol (DHCP) for IPv4. DHCPv6 is described in RFC 8415.

The device uses a DHCP Unique Identifier (DUID) to send a request to the DHCPv6 server. In the device, the DUID represents the *Client ID* that the DHCPv6 server uses to identify the device that requested an IPv6 address.

The *Client ID* is displayed in the *Basic Settings > Network > IPv6* dialog, in the *DHCP* frame.

The device can receive only one IPv6 address from the DHCPv6 server, with a *PrefixLength* of 128. No *Gateway address* information is provided. If needed, you can manually specify *Gateway address* information.

In the default setting, DHCPv6 protocol is deactivated. You can activate or deactivate the protocol in the *Basic Settings > Network > IPv6* dialog. Verify that the *DHCPv6* radio button is selected in the *Configuration* frame.

If you want to dynamically get an IPv6 address with a *PrefixLength* other than *128*, then select the *Auto* radio button. An example here is the use of a Router Advertisement Daemon (radvd). The radvd uses *Router Solicitation* and *Router Advertisement* messages to automatically set up an IPv6 address.

In the default setting, the *Auto* radio button is selected. You can select or deselect the *Auto* radio button in the *Basic Settings > Network > IPv6* dialog, in the *Configuration* frame.

If the *All* radio button is selected, then the device receives its IPv6 parameters using every alternative for both dynamic and manual assignments.

2.7 Management address conflict detection

You assign an IP address to the device using several different methods. This function helps the device detect IP address conflicts on a network after the system startup and the device also checks periodically during operation. This function is described in RFC 5227.

When enabled, the device sends an SNMP trap informing you that it detected an IP address conflict.

The following list contains the default settings for this function:

- *Operation*: On
- *Detection mode*: active and passive
- *Send periodic ARP probes*: marked
- *Detection delay [ms]*: 200
- *Release delay [s]*: 15
- *Address protections*: 3
- *Protection interval [ms]*: 200
- *Send trap*: marked

2.7.1 Active and passive detection

Actively checking the network helps prevent the device from connecting to the network with a duplicate IP address. After connecting the device to a network or after configuring the IP address, the device immediately checks if its IP address exists within the network. To check the network for address conflicts, the device sends 4 ARP probes with the detection delay of 200 ms into the network. When the IP address exists, the device attempts to return to the previous configuration, and make another check after the specified release delay time.

When you disable active detection, the device sends 2 gratuitous ARP announcements in 2 s intervals. Using the ARP announcements with passive detection enabled, the device polls the network to determine if there is an address conflict. After resolving an address conflict or after expired release delay time, the device reconnects to the network. Following 10 detected conflicts, when the specified release delay interval is less than 60 s, the device sets the release delay interval to 60 s.

After the device performs active detection or you disable the active detection function, with passive detection enabled the device listens on the network for other devices using the same IP address. When the device detects a duplicate IP address, it initially defends its address by employing the ACD mechanism in the passive detection mode and sends out gratuitous ARPs. The number of protections that the device sends and the protection interval are configurable. To resolve conflicts, if the remote device remains connected to the network, then the network interface of the local device disconnects from the network.

When a DHCP server assigns an IP address to the device and an address conflict occurs, the device returns a DHCP decline message.

The device uses the ARP probe method. This has the following advantages:

- ▶ ARP caches on other devices remain unchanged
- ▶ the method is robust through multiple ARP probe transmissions

2.8 Duplicate Address Detection function

The *Duplicate Address Detection* function determines the uniqueness of an IPv6 unicast address on an interface. The function is performed when an IPv6 address is set up manually, or using the *DHCPv6*, or *Auto* methods. The function is also triggered by a change in a link status, for example, a link status change from down to up.

The *Duplicate Address Detection* function uses *Neighbor Solicitation* and *Neighbor Advertisement* messages. You have the option to set the number of consecutive *Neighbor Solicitation* messages that the device sends. To do this, perform the following steps:

- Open the *Basic Settings > Network > IPv6* dialog.
- In the *Duplicate Address Detection* frame set the necessary value in the *Number of neighbor solicitants* field.
Possible values:
 - 0
The function is disabled.
 - 1..5 (default setting: 1)
- Apply the settings temporarily. To do this, click the ✓ button.

```
enable  
network ipv6 dad-transmits <0..5>
```

To change to the Privileged EXEC mode.
To set the number of *Neighbor Solicitation* messages that the device sends.
The value 0 disables the function.

Note: If the *Duplicate Address Detection* function discovers that an IPv6 address is not unique on a link, then the device does not log this event in the log file (System Log).

3 Access to the device

3.1 First login (Password change)

To help prevent undesired access to the device, it is imperative that you change the default password during initial setup.

Perform the following steps:

- Open the Graphical User Interface, the HiView application, or the Command Line Interface the first time you log into the device management.
- Log into the device management with the default password.
The device prompts you to type in a new password.
- Type in your new password.
To help increase security, choose a password that contains at least 8 characters which includes upper-case characters, lower-case characters, numerical digits, and special characters.
- When you log into the device management through the Command Line Interface, the device prompts you to confirm your new password.
- Log into the device management again with your new password.

Note: If you lost your password, then contact your local support team.

For further information, see hirschmann-support.belden.com.

3.2 Authentication lists

When a user accesses the device management using a specific connection, the device verifies the login credentials of the user through an authentication list which contains the policies that the device applies for authentication.

The prerequisite for a user to access the device management is that at least one policy is assigned to the authentication list of the application through which access is performed.

3.2.1 Applications

The device provides an application for each type of connection through which someone accesses the device:

- ▶ Access to the Command Line Interface using a serial connection: [Console\(V.24\)](#)
- ▶ Access to the Command Line Interface using SSH: [SSH](#)
- ▶ Access to the Command Line Interface using Telnet: [Telnet](#)
- ▶ Access to the Graphical User Interface: [WebInterface](#)

The device also provides an application to control the access to the network from connected end devices using port-based access control: [8021x](#)

3.2.2 Policies

When a user logs in with valid login data, the device lets the user have access to its device management. The device authenticates the users using the following policies:

- ▶ User management of the device
- ▶ RADIUS

When the end device logs in with valid login data, the device lets the connected end devices have access to the network with the port-based access control according to IEEE 802.1X. The device authenticates the end devices using the following policies:

- ▶ RADIUS
- ▶ IAS (Integrated Authentication Server)

The device gives you the option of a fall-back solution. For this, you specify more than one policy in the authentication list. When authentication is unsuccessful using the current policy, the device applies the next specified policy.

3.2.3 Managing authentication lists

You manage the authentication lists in the Graphical User Interface or in the Command Line Interface. To do this, perform the following steps:

- Open the [Device Security > Authentication List](#) dialog.
The dialog displays the authentication lists that are set up.

`show authlists` To display the authentication lists that are set up.

- Deactivate the authentication list for those applications by means of which no access to the device is performed, for example `8021x`.

- In the *Active* column of the authentication list `defaultDot1x8021AuthList`, unmark the checkbox.
- Apply the settings temporarily. To do this, click the  button.

`authlists disable defaultDot1x8021AuthList` To deactivate the authentication list `defaultDot1x8021AuthList`.

3.2.4 Adjusting the settings

Example: Set up a separate authentication list for the application `WebInterface` which is by default included in the authentication list `defaultLoginAuthList`.

The device forwards authentication requests to a RADIUS server in the network. As a fall-back solution, the device authenticates users using the local user management. To do this, perform the following steps:

- Create an authentication list `loginGUI`.

- Open the *Device Security > Authentication List* dialog.
- Click the  button.
The dialog displays the *Create* window.
 - Enter a meaningful name in the *Name* field.
In this example, enter the name `loginGUI`.
 - Click the *Ok* button.
The device adds a table row.

`enable` To change to the Privileged EXEC mode.

`configure` To change to the Configuration mode.

`authlists add loginGUI` To add the authentication list `loginGUI`.

- Select the policies for the authentication list `loginGUI`.

- In the *Policy 1* column, select the value `radius`.
- In the *Policy 2* column, select the value `Local`.
- In the *Policy 3* to *Policy 5* columns, select the value `reject` to help prevent further fall-back.
- Apply the settings temporarily. To do this, click the  button.

```
authlists set-policy loginGUI radius local  
reject reject reject
```

To assign the policies *radius*, *local* and *reject* to the authentication list *loginGUI*.

```
show authlists
```

To display the authentication lists that are set up.

- Assign an application to the authentication list *loginGUI*.

- Open the *Device Security > Authentication List* dialog.

- In the table, select the authentication list *loginGUI*.

- Click the  button.

The dialog displays the *Allocate applications* window.

- Click the application *WebInterface* to highlight it.

- Click the *Ok* button.

The dialog displays the updated settings:

- The *Dedicated applications* column of authentication list *loginGUI* displays the application *WebInterface*.

- The *Dedicated applications* column of authentication list *defaultLoginAuthList* does not display the application *WebInterface* anymore.

- Apply the settings temporarily. To do this, click the  button.

```
show appllists
```

To display the applications and the allocated lists.

```
appllists set-authlist WebInterface  
loginGUI
```

To assign the *loginGUI* application to the authentication list *WebInterface*.

3.3 User management

When a user logs in with valid login data, the device lets the user have access to its device management. The device authenticates the users either using the local user management or with a RADIUS server in the network. To get the device to use the user management, assign the *Local* policy to an authentication list, see the *Device Security > Authentication List* dialog.

In the local user management, you manage the user accounts. One user account is usually allocated to each user.

3.3.1 Access roles

The device lets you use a role-based authorization model to specifically control the access to the device management. Users to whom a specific authorization profile is allocated are allowed to use commands and functions from the same authorization profile or a lower one.

The device uses the authorization profiles on every application with which the device management can be accessed.

Note: The following applies to the Command Line Interface: Users to whom a specific authorization profile is assigned are allowed to use commands and functions from this authorization profile or a lower level role. The commands available to a user also depend on the Command Line Interface mode in which the user is currently working. See “[Mode-based command hierarchy](#)” on page 22.

Every user account is linked to an access role that regulates the access to the individual functions of the device. Depending on the planned activity for the respective user, you assign a pre-defined access role to the user. The device differentiates between the following access roles.

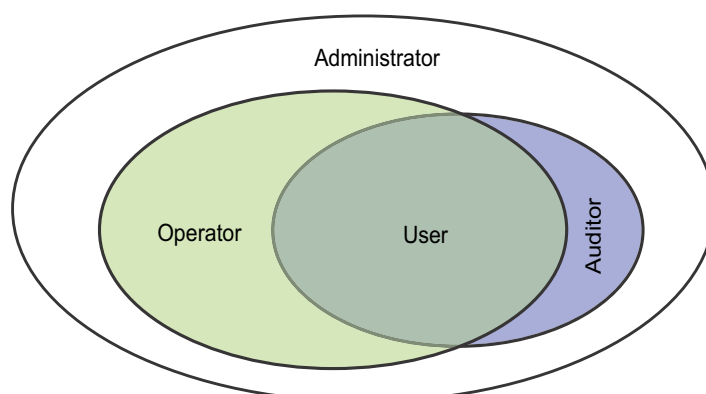

Figure 17: Access roles for user accounts

Table 13: Access roles for user accounts

Role	Description	Authorized for the following activities
<i>administrator</i>	The user is authorized to monitor and administer the device.	All activities with read/write access, including the following activities reserved for an administrator: <ul style="list-style-type: none"> ▶ Add, modify or delete user accounts ▶ Activate, deactivate or unlock user accounts ▶ Change every password ▶ Set up the password management ▶ Set or change system time ▶ Load files to the device, for example, device settings, certificates, or device software images ▶ Reset settings and security-related settings to the state on delivery ▶ Set up the RADIUS server and authentication lists ▶ Apply scripts using the Command Line Interface ▶ Enable/disable CLI logging and SNMP logging ▶ External memory activation and deactivation ▶ System monitor activation and deactivation ▶ Enable/disable the services for the access to the device management (for example SNMP). ▶ Set up access restrictions to the Graphical User Interface or the Command Line Interface based on the IP addresses
<i>operator</i>	The user is authorized to monitor and set up the device, with the exception of security-related settings.	All activities with read/write access, with the exception of the above-named activities, which are reserved for an administrator:
<i>auditor</i>	The user is authorized to monitor the device and to save the log file in the <i>Diagnostics > Report > Audit Trail</i> dialog.	Monitoring activities with read access.
<i>guest</i>	The user is authorized to monitor the device - with the exception of security-related settings.	Monitoring activities with read access.
<i>unauthorized</i>	No access to the device possible. <ul style="list-style-type: none"> ▶ As an administrator you assign this access role to temporarily lock a user account. ▶ If an administrator assigns a different access role to the user account and an error is detected, then the device assigns this access role to the user account. 	No activities allowed.

3.3.2 Managing user accounts

You manage the user accounts in the Graphical User Interface or in the Command Line Interface. To do this, perform the following steps:

- Open the *Device Security > User Management* dialog. The dialog displays the user accounts that are set up.

`show users` To display the user accounts that are set up.

3.3.3 Default user accounts

In the default setting, the user account `admin` is set up in the device.

Table 14: Settings of the default user account

Parameter	Default setting
<i>User name</i>	<code>admin</code>
<i>Password</i>	<code>private</code>
<i>Role</i>	<code>administrator</code>
<i>User locked</i>	<code>unmarked</code>
<i>Policy check</i>	<code>unmarked</code>
<i>SNMP auth type</i>	<code>hmacmd5</code>
<i>SNMP encryption type</i>	<code>des</code>

Change the password for the `admin` user account before making the device available in the network.

3.3.4 Changing default passwords

To help prevent undesired access, change the password of the default user account. To do this, perform the following steps:

- Change the password for the `admin` user account.

- Open the *Device Security > User Management* dialog. The dialog displays the user accounts that are set up.
- To require a specified minimum complexity for the passwords, mark the checkbox in the *Policy check* column. Before saving it, the device checks the password according to the policy specified in the *Password policy* frame.

Note: The password check can lead to a message in the *Security status* frame in the *Basic Settings > System* dialog. You specify the settings that cause this message in the *Basic Settings > System* dialog.

- Click the table row of the relevant user account in the *Password* field. Enter a password of at least 6 characters.
Up to 64 alphanumeric characters are allowed.
 - ▶ The device differentiates between upper and lower case.
 - ▶ The minimum length of the password is specified in the *Configuration* frame. The device constantly checks the minimum length of the password.
- Apply the settings temporarily. To do this, click the  button.

enable

To change to the Privileged EXEC mode.

configure

To change to the Configuration mode.

users password-policy-check <user> enable

To activate the checking of the password for the <user> user account based on the specified policy. In this way, you require a specified minimum complexity for the passwords.

Note: When you display the security status, the password check can lead to a message (`show security-status all`). You specify the settings that cause this message with the command `security-status monitor pwd-policy-inactive`.

users password USER SECRET

To specify the password **SECRET** for the user account **USER**. Enter at least 6 characters.

save

To save the settings in the non-volatile memory (*nvm*) in the “Selected” configuration profile.

3.3.5 Setting up a new user account

Allocate a separate user account to each user that accesses the device management. In this way you can specifically control the authorizations for the access.

In the following example, you set up the user account for a user **USER** with the access role *operator*. Users with the access role *operator* are authorized to monitor and set up the device, with the exception of security-related settings. To do this, perform the following steps:

- Create a user account.

- Open the *Device Security > User Management* dialog.
- Click the  button.
The dialog displays the *Create* window.
- Enter the name in the *User name* field.
In this example, you give the user account the name **USER**.
- Click the *Ok* button.
- To require a specified minimum complexity for the passwords, mark the checkbox in the *Policy check* column.
Before saving it, the device checks the password according to the policy specified in the *Password policy* frame.

- In the *Password* field, enter a password of at least 6 characters. Up to 64 alphanumeric characters are allowed.
 - ▶ The device differentiates between upper and lower case.
 - ▶ The minimum length of the password is specified in the *Configuration* frame. The device constantly checks the minimum length of the password.
- In the *Role* column, select the access role. In this example, you select the value *operator*.
- To activate the user account, mark the checkbox in the *Active* column.
- Apply the settings temporarily. To do this, click the button. The dialog displays the user accounts that are set up.

enable	To change to the Privileged EXEC mode.
configure	To change to the Configuration mode.
users add USER	To add the <i>USER</i> user account.
users password-policy-check USER enable	To activate the checking of the password for the <i>USER</i> user account based on the specified policy. In this way, you require a specified minimum complexity for the passwords.
users password USER SECRET	To specify the password <i>SECRET</i> for the user account <i>USER</i> . Enter at least 6 characters.
users access-role USER operator	To assign the access role <i>operator</i> to the user account <i>USER</i> .
users enable USER	To activate the user account <i>USER</i> .
show users	To display the user accounts that are set up.
save	To save the settings in the non-volatile memory (<i>nvm</i>) in the "Selected" configuration profile.

Note: When you are setting up a new user account in the Command Line Interface, remember to allocate the password.

3.3.6 Deactivating the user account

After a user account is deactivated, the device denies the related user access to the device management. In contrast to completely deleting it, deactivating a user account lets you keep the settings and reuse them in the future. To do this, perform the following steps:

- To keep the user account settings and reuse them in the future, you temporarily deactivate the user account.

- Open the *Device Security > User Management* dialog. The dialog displays the user accounts that are set up.
- In the table row for the relevant user account, unmark the checkbox in the *Active* column.
- Apply the settings temporarily. To do this, click the button.

enable	To change to the Privileged EXEC mode.
configure	To change to the Configuration mode.
users disable <user>	To disable user account.
show users	To display the user accounts that are set up.
save	To save the settings in the non-volatile memory (<i>nvm</i>) in the "Selected" configuration profile.

To permanently deactivate the user account settings, you delete the user account.

- Select the table row of the relevant user account.
- Click the  button.

users delete <user>	To delete the user account <user>.
show users	To display the user accounts that are set up.
save	To save the settings in the non-volatile memory (<i>nvm</i>) in the "Selected" configuration profile.

3.3.7 Adjusting policies for passwords

The device lets you check if the passwords for the user accounts match the specified policy. When the passwords match the policy, you obtain a higher complexity for the passwords.

The user management of the device lets you activate or deactivate the check separately in each user account. When you mark the checkbox and the new password fulfills the requirements of the policy, the device accepts the password change.

In the default settings, practical values for the policy are set up in the device. You have the option of adjusting the policy to meet your requirements. To do this, perform the following steps:

- Adjust the policy for passwords to meet your requirements.

- Open the *Device Security > User Management* dialog.

In the *Configuration* frame you specify the number of consecutive unsuccessful login attempts before the device locks out the user. You also specify the minimum number of characters that defines a password.

Note: The device lets only users with the *administrator* authorization remove the lock.

The number of consecutive unsuccessful login attempts as well as the possible lockout of the user apply only when accessing the device management through:

- ▶ the Graphical User Interface
- ▶ the SSH protocol
- ▶ the Telnet protocol

Note: Accessing the device management using the Command Line Interface through the serial connection, the number of login attempts is unlimited.

- Specify the values to meet your requirements.
 - ▶ In the *Login attempts* field you specify the number of times that a user can attempt to log into the device management. The field lets you define this value in the range *0..5*. In the above example, the value *0* deactivates the function.
 - ▶ The *Min. password length* field lets you enter values in the range *1..64*.

The dialog displays the policy set up in the *Password policy* frame.

- Adjust the values to meet your requirements.
 - ▶ Values in the range *1* through *16* are allowed. The value *0* deactivates the relevant policy.

To apply the entries specified in the *Configuration* and *Password policy* frames, mark the checkbox in the *Policy check* column for a particular user.

- Apply the settings temporarily. To do this, click the button.

enable	To change to the Privileged EXEC mode.
configure	To change to the Configuration mode.
passwords min-length 6	To specify the policy for the minimum length of the password.
passwords min-lowercase-chars 1	To specify the policy for the minimum number of lower-case letters in the password.
passwords min-numeric-chars 1	To specify the policy for the minimum number of digits in the password.
passwords min-special-chars 1	To specify the policy for the minimum number of special characters in the password.
passwords min-uppercase-chars 1	To specify the policy for the minimum number of upper-case letters in the password.
show passwords	To display the policies that are set up.
save	To save the settings in the non-volatile memory (<i>nvm</i>) in the "Selected" configuration profile.

3.4 SNMP access

The Simple Network Management Protocol (SNMP) lets you work with a network management system to monitor the device over the network and change its settings.

3.4.1 SNMPv1/v2 access

Using SNMPv1 or SNMPv2 the network management system and the device communicate unencrypted. Every SNMP packet contains the *community name* in plain text and the IP address of the sender.

The *community names* [public](#) for *read-only* access and [private](#) for *read and write* access are preset in the device. If SNMPv1/v2 is enabled, then the device lets anyone who knows the *community name* have access to the device.

Make undesired access to the device more difficult. To do this, perform the following steps:

- Change the default *community names* in the device.
Treat the *community names* with discretion.
Anyone who knows the *community name* for write access, has the ability to change the settings of the device.
- Specify a different *community name* for *read and write* access than for *read-only* access.
- Use SNMPv1 or SNMPv2 only in environments protected from eavesdropping. The protocols do not use encryption.
-
- We recommend using SNMPv3 and disabling the access using SNMPv1 and SNMPv2 in the device.

3.4.2 SNMPv3 access

Using SNMPv3 the network management system and the device communicate encrypted. The network management system authenticates itself with the device using the login credentials of a user. The prerequisite for the SNMPv3 access is that in the network management system uses the same settings that are defined in the device.

The device lets you specify the [SNMP auth type](#) and [SNMP encryption type](#) parameters individually in each user account.

When you set up a new user account in the device, the parameters are preset so that the network management system Industrial HiVision reaches the device immediately.

The user accounts set up in the device use the same passwords in the Graphical User Interface, in the Command Line Interface, and for SNMPv3.

To adapt the SNMPv3 parameters of the user account settings to the settings in the network management system, perform the following steps:

- Open the *Device Security > User Management* dialog. The dialog displays the user accounts that are set up.
- Click the table row of the relevant user account in the *SNMP auth type* field. Select the desired setting.
- Click the table row of the relevant user account in the *SNMP encryption type* field. Select the desired setting.
- Apply the settings temporarily. To do this, click the button.

enable	To change to the Privileged EXEC mode.
configure	To change to the Configuration mode.
users snmpv3 authentication <user> md5 sha1	To assign the HMAC-MD5 or HMACSHA protocol for authentication requests to the user account <user>.
users snmpv3 encryption <user> des aes128 none	To assign the DES or AES-128 algorithm to the user account <user>. With this algorithm, the device encrypts authentication requests. The value <i>none</i> removes the encryption.
show users	To display the user accounts that have been set up.
save	To save the settings in the non-volatile memory (<i>nvm</i>) in the "Selected" configuration profile.

3.4.3 SNMPv3 traps

SNMP version 3 lets the device use encrypted communication with a network management system.

For this, you need to set up the following roles in the device:

- [SNMPv3 trap users](#)
- [SNMPv3 trap hosts](#)

SNMPv3 trap users

An *SNMPv3 trap* user has the permission to send *SNMPv3 traps* to the specified *SNMPv3 trap* hosts.

An *SNMPv3 trap* user is exclusively for sending *SNMPv3 traps* to *SNMPv3 trap* hosts. Do not confuse *SNMPv3 trap* users with device user accounts. See section "[Managing user accounts](#)" on [page 69](#).

The device supports encryption and authentication for sending *SNMPv3 traps*. The device lets you set up *SNMPv3 trap* users.

The device supports the following authentication and encryption types:

- `auth-no-priv`
The user needs to authenticate to send *SNMPv3 traps*. The device sends the *SNMPv3 traps* unencrypted.
- `auth-priv`
The user needs to authenticate to send *SNMPv3 traps*. The device sends the *SNMPv3 traps* encrypted.
- `no-auth`
For security reasons, not recommended.
The device sends the *SNMPv3 traps* unencrypted without authentication.

To add an *SNMPv3 trap* user, perform the following steps:

```
enable
configure
snmp notification user add <name1> auth-
priv auth sha1 <passphrase1> priv des
<passphrase2>

show snmp notification users

save
```

To change to the Privileged EXEC mode.

To change to the Configuration mode.

To add the *SNMPv3 trap* user `<name1>`:

- With authentication and encryption
- SNMPv3 authentication parameters
- SHA1 as the cryptographic hash function for *SNMPv3 trap* user authentication
- `<passphrase1>` as passphrase
- SNMPv3 encryption parameters
- DES as the *SNMPv3 trap* encryption algorithm
- `<passphrase2>` as passphrase.

To display the *SNMPv3 trap* user settings.

To save the settings in the non-volatile memory (*nvm*) in the “Selected” configuration profile.

To modify an existing *SNMPv3 trap* user, delete the user and add a new user with the desired settings.

To delete an *SNMPv3 trap* user, perform the following steps:

```
enable
configure
snmp notification user delete <name1>

save
```

To change to the Privileged EXEC mode.

To change to the Configuration mode.

To delete the *SNMPv3 trap* user `<name1>`.

To save the settings in the non-volatile memory (*nvm*) in the “Selected” configuration profile.

SNMPv3 trap hosts

An *SNMPv3 trap* host is the destination for an *SNMPv3 trap* that the device sends.

The device supports a maximum of 10 *SNMP trap* hosts.

To specify an *SNMPv3 trap* host, perform the following steps:

```
enable
configure
```

To change to the Privileged EXEC mode.

To change to the Configuration mode.

```
snmp notification host add <hostname1>  
a.b.c.d user <name2> auth-priv
```

To add the *SNMPv3 trap* host <hostname1>

- With the IPv4 address <a.b.c.d>
- Username <name2>
- With authentication and encryption

```
show snmp notification hosts
```

To display the *SNMPv3 trap* host settings.

```
save
```

To save the settings in the non-volatile memory (*nvm*) in the “Selected” configuration profile.

To modify an existing *SNMPv3 trap* host, delete the host and add a new host with the desired settings.

To delete an *SNMPv3 trap* host, perform the following steps:

```
enable
```

To change to the Privileged EXEC mode.

```
configure
```

To change to the Configuration mode.

```
snmp notification host delete <hostname1>
```

To delete the *SNMPv3 trap* host <hostname1>.

```
save
```

To save the settings in the non-volatile memory (*nvm*) in the “Selected” configuration profile.

4 Synchronizing the system time in the network

Many applications rely on a time that is as correct as possible. The necessary accuracy, and thus the allowable deviation from the actual time, depends on the application area.

Examples of application areas include:

- Log entries
- Time stamping of production data
- Process control

The device lets you synchronize the time in the network using the following options:

- The Simple Network Time Protocol (SNTP) is a simple solution for low accuracy requirements. Under ideal conditions, the Simple Network Time Protocol (SNTP) achieves accuracy in the millisecond range. The accuracy depends on the signal delay.
- The Precision Time Protocol (PTP) along with IEEE 1588 achieves accuracy on the order of sub-microseconds. This protocol is suitable for demanding applications up to and including process control.

When the involved devices support the Precision Time Protocol (PTP), it is the better choice. The Precision Time Protocol (PTP) is more accurate, has advanced methods of error correction, and causes only a low network load. The implementation of the Precision Time Protocol (PTP) is comparatively easy.

Note: According to the Precision Time Protocol (PTP) and Simple Network Time Protocol (SNTP) standards, both protocols can operate in parallel in the same network. However, since both protocols can influence the system time of the device, situations can occur in which the two protocols conflict with each other.

4.1 Setting the time

When there is no reference time source available to you, you can manually set the system time in the device.

When you start the device after it has been powered down for some time, it initializes the clock with January 1 2024, 01:00 UTC+1. After powered down, the device buffers the settings of its real-time clock for up to 24 hours.

As an alternative, you can set up the device to obtain the current time using one of the following protocols:

- Simple Network Time Protocol
- Precision Time Protocol

Perform the following steps:

- Open the *Time > Basic Settings* dialog.
- ▶ The *System time (UTC)* field displays the current date and time with reference to Universal Time Coordinated (UTC). UTC is the same worldwide and does not take local time shifts into account.
- ▶ The time in the *System time* field comes from the *System time (UTC)* plus the *Local offset [min]* value and a possible shift due to daylight saving time.

Note: PTP sends the International Atomic Time (TAI). As of July 1, 2020, the TAI time is 37 s ahead of the Universal Time Coordinated (UTC). When the PTP reference time source of the UTC offset is set correctly, the device automatically corrects this difference on the display in the *System time (UTC)* field.

- To make the device apply the time of your computer to the *System time* field, click the *Set time from PC* button.

Based on the value in the *Local offset [min]* field, the device calculates the time in the *System time (UTC)* field: The *System time (UTC)* comes from the *System time* minus the *Local offset [min]* value and a possible shift due to daylight saving time.

- ▶ The *Time source* field displays the origin of the time data. The device automatically selects the source with the greatest accuracy.

The source is initially *Local*.

When SNTP is active and the device receives a valid SNTP packet, the device sets its time source to *sntp*.

When PTP is active and the device receives a valid PTP message, the device sets its time source to *ptp*. The device prioritizes PTP ahead of SNTP.

- ▶ The *Local offset [min]* value specifies the difference in minutes between Universal Time Coordinated (UTC) and local time.

- To cause the device to determine the time zone on your PC, click the *Set time from PC* button. The device calculates the difference between local time and Universal Time Coordinated (UTC), and enters the difference into the *Local offset [min]* field.

Note: The device provides the option to obtain the local offset from a DHCP server.

- Apply the settings temporarily. To do this, click the button.

enable

To change to the Privileged EXEC mode.

configure

To change to the Configuration mode.

clock set <YYYY-MM-DD> <HH:MM:SS>

To set the system time of the device.

clock timezone offset <-780..840>

To enter the difference in minutes between the local time and the received Universal Time Coordinated (UTC).

save

To save the settings in the non-volatile memory (nvram) in the "Selected" configuration profile.

4.2 Automatic daylight saving time changeover

When you operate the device in a time zone with a summer time change, the device lets you set up the automatic daylight saving time changeover.

If the *Daylight saving time* mode is enabled, the device advances the local system time by one hour during the summer time. At the end of summer time, the device sets the local system time back again by one hour.

4.2.1 Setting daylight saving time using pre-defined profiles

The device lets you specify the start and end of daylight saving time using pre-defined profiles.

The device includes the following pre-defined profiles:

- [EU](#)
Daylight saving time settings as applicable in the European Union.
- [USA](#)
Daylight saving time settings as applicable in the United States of America.

To select the [EU](#) profile for the daylight saving time settings, perform the following steps:

- Open the *Time > Basic Settings* dialog, *Daylight saving time* tab.
- In the *Operation* frame, click the *Profile...* button.
- Select the [EU](#) item from the *Profile...* list.
Selecting a profile overwrites the settings specified in the *Summertime begin* and *Summertime end* frames.
- Click the *Ok* button.
- Apply the settings temporarily. To do this, click the button.

enable

configure

clock summer-time mode eu

To change to the Privileged EXEC mode.

To change to the Configuration mode.

To enable the *Daylight saving time* mode with the profile eu.

4.2.2 Setting daylight saving time manually

The network administrator wants to specify the following daylight saving time settings:

Summertime begin

- *Week = Last*
- *Day = Sunday*
- *Month = March*
- *System time = 02:00*

Summertime end

- *Week = Last*
- *Day = Sunday*

- *Month = October*
- *System time = 03:00*

For the purpose described above, perform the following steps:

- Open the *Time > Basic Settings* dialog, *Daylight saving time* tab.
- Enable the *Daylight saving time* mode. To do this, in the *Operation* frame, select the *On* radio button.
- In the *Summertime begin* frame, specify the following settings:
 - *Week = Last*
 - *Day = Sunday*
 - *Month = March*
 - *System time = 02:00*
- In the *Summertime end* frame, specify the following settings:
 - *Week = Last*
 - *Day = Sunday*
 - *Month = October*
 - *System time = 03:00*
- Apply the settings temporarily. To do this, click the button.

enable

configure

clock summer-time mode recurring

```
clock summer-time recurring start last sun  
mar 02:00
```

```
clock summer-time recurring end last sun  
oct 03:00
```

To change to the Privileged EXEC mode.

To change to the Configuration mode.

To enable the *Daylight saving time* mode.

To specify the time at which the device sets the clock forward from standard time to summer time.

- last
To specify the *Last* week in the month.
- sun
To specify the day *Sunday*.
- mar
To specify the month *March*.
- 02:00
To specify the time *02:00*.

To specify the time at which the device resets the clock from summer time to standard time.

- last
To specify the *Last* week in the month.
- sun
To specify the day *Sunday*.
- oct
To specify the month *October*.
- 03:00
To specify the time *03:00*.

4.3 Synchronizing time in the network with SNTP

The Simple Network Time Protocol (SNTP) lets you synchronize the system time in the network. The device supports the SNTP client and the SNTP server function.

The SNTP server makes the Universal Time Coordinated (UTC) available. UTC is the time relating to the coordinated world time measurement. UTC is the same worldwide and does not take local time shifts into account.

SNTP is a simplified version of Network Time Protocol (NTP). The data packets are identical with SNTP and NTP. Accordingly, both NTP and SNTP servers serve as a time source for SNTP clients.

Note: Statements in this chapter relating to external SNTP servers also apply to NTP servers.

SNTP knows the following operation modes for the transmission of time:

- ▶ **Unicast**
In *Unicast* operation mode, an SNTP client sends requests to an SNTP server and expects a response from this server.
- ▶ **Broadcast**
In *Broadcast* operation mode, an SNTP server sends SNTP messages to the network in specified intervals. SNTP clients receive these SNTP messages and evaluate them.

In an IPv6 environment, the *Broadcast* operation mode operates as follows:

- ▶ The SNTP client listens only for SNTP server messages that have the IPv6 *Multicast* address set to `ff05::101` as the IPv6 destination address.
- ▶ The SNTP server sends only SNTP messages to the *Multicast* address `ff05::101`. The SNTP server does not send SNTP messages with the link-local address as the IPv6 source address.

Table 15: Target IPv4 address classes for Broadcast operation mode

IPv4 destination address	Send SNTP packets to
0.0.0.0	Nobody
224.0.1.1	<i>Multicast</i> address for SNTP messages
255.255.255.255	<i>Broadcast</i> address

Note: An SNTP server in *Broadcast* operation mode also responds to direct requests using *Unicast* from SNTP clients. In contrast, SNTP clients work in either *Unicast* or *Broadcast* operation mode.

4.3.1 Preparation

Perform the following steps:

- To get an overview of how the time is passed on, draw a network plan with the devices participating in SNTP.

When planning, bear in mind that the accuracy of the time depends on the delays of the SNTP messages. To minimize delays and their variance, place an SNTP server in each network segment. Each of these SNTP servers synchronizes its own system time as an SNTP client with its parent SNTP server (SNTP cascade). The highest SNTP server in the SNTP cascade has the most direct access to a reference time source.

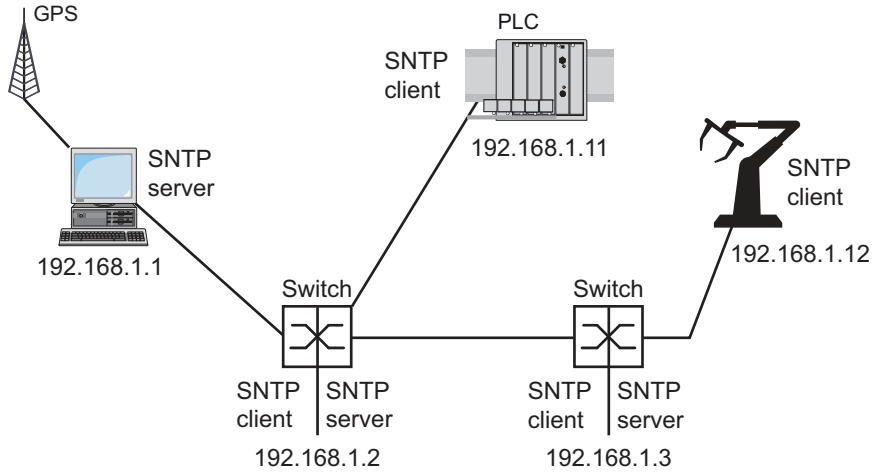

Figure 18: Example of SNTP cascade

Note: For precise time distribution, between SNTP servers and SNTP clients you preferably use network components (routers and switches) that forward the SNTP packets with a low and uniform transmission time (latency).

- ▶ An SNTP client sends its requests to up to 4 set-up SNTP servers. When there is no response from the first SNTP server, the SNTP client sends its requests to the second SNTP server. When this request is also unsuccessful, it sends the request to the 3rd and finally to the 4th SNTP server. If none of these SNTP servers respond, the SNTP client loses its synchronization. The SNTP client periodically sends requests to each SNTP server until a server delivers a valid time.

Note: The device provides the option of obtaining a list of SNTP server IP addresses from a DHCP server.

- If no reference time source is available to you, then determine a device with an SNTP server as a reference time source. Adjust its system time at regular intervals.

4.3.2 Defining settings of the SNTP client

As an SNTP client, the device obtains the time information from SNTP or NTP servers and synchronizes its system clock accordingly. To do this, perform the following steps:



- Open the *Time > SNTP > Client* dialog.
- Set the SNTP operation mode.
In the *Configuration* frame, select one of the following values in the *Mode* field:
 - ▶ *unicast*
The device sends requests to an SNTP server and expects a response from this server.
 - ▶ *broadcast*
The device waits for *Broadcast* or *Multicast* messages from SNTP servers on the network.
- To synchronize the time only once, mark the *Disable client after successful sync* checkbox. After synchronization, the device disables the *Client* function.
- ▶ The table displays the SNTP server to which the SNTP client sends a request in *Unicast* operation mode. The table contains up to 4 SNTP server definitions.
- To add a table row, click the  button.
- Specify the connection data of the SNTP server.
- To enable the function, select the *On* radio button in the *Operation* frame.
- Apply the settings temporarily. To do this, click the  button.
- ▶ The *State* field displays the current status of the *Client* function.

Table 16: SNTP client settings for the example

Device	192.168.1.1	192.168.1.2	192.168.1.3	192.168.1.11	192.168.1.12
<i>Client</i> function	<i>Off</i>	<i>On</i>	<i>On</i>	<i>On</i>	<i>On</i>

Table 16: SNTP client settings for the example (cont.)

Device	192.168.1.1	192.168.1.2	192.168.1.3	192.168.1.11	192.168.1.12
Configuration: Mode	unicast	unicast	unicast	unicast	unicast
Request interval [s]	30	30	30	30	30
Server address(es)	-	192.168.1.1	192.168.1.21 92.168.1.1	192.168.1.21 92.168.1.1	192.168.1.31 92.168.1.219 2.168.1.1

4.3.3 Specifying SNTP server settings

When operating as an SNTP server, the device distributes its system time as Universal Time Coordinated (UTC) to the network. To do this, perform the following steps:

- Open the *Time > SNTP > Server* dialog.
- To enable the function, select the *On* radio button in the *Operation* frame.
- To enable the *Broadcast* operation mode, select the *Broadcast admin mode* radio button in the *Configuration* frame.
In *Broadcast* operation mode, the SNTP server sends SNTP messages to the network in specified intervals. The SNTP server also responds to the requests from SNTP clients in *Unicast* operation mode.
 - In the *Broadcast destination address* field, you set the IPv4 address to which the SNTP server sends the SNTP packets. Set a *Broadcast* address or a *Multicast* address.
In an IPv6 environment, you cannot set the IPv6 address to which the SNTP server sends the SNTP packets. The SNTP server uses the *Multicast* address *ff05::101* as the IPv6 destination address.
 - In the *Broadcast UDP port* field, you specify the number of the UDP port to which the SNTP server sends the SNTP packets in *Broadcast* operation mode.
 - In the *Broadcast VLAN ID* field, you specify the VLAN to which the SNTP server sends the SNTP packets in *Broadcast* operation mode.
 - In the *Broadcast send interval [s]* field, you specify the time interval at which the SNTP server of the device sends SNTP *Broadcast* packets.

Note: Except for the *Broadcast destination address* field, the remaining settings are applicable for both IPv4 and IPv6 SNTP servers.

- Apply the settings temporarily. To do this, click the button.
- ▶ The *State* field displays the current status of the *Server* function.

Table 17: Settings for the example

Device	192.168.1.1	192.168.1.2	192.168.1.3	192.168.1.11	192.168.1.12
Server function	On	On	On	Off	Off
UDP port	123	123	123	123	123
Broadcast admin mode	unmarked	unmarked	unmarked	unmarked	unmarked
Broadcast destination address	0.0.0.0	0.0.0.0	0.0.0.0	0.0.0.0	0.0.0.0
Broadcast UDP port	123	123	123	123	123

Table 17: Settings for the example (cont.)

Device	192.168.1.1	192.168.1.2	192.168.1.3	192.168.1.11	192.168.1.12
<i>Broadcast VLAN ID</i>	1	1	1	1	1
<i>Broadcast send interval [s]</i>	128	128	128	128	128
<i>Disable server at local time source</i>	unmarked	unmarked	unmarked	unmarked	unmarked

4.4 Synchronizing time in the network with PTP

For LAN-controlled applications to operate without latency, precise time management is required. With Precision Time Protocol (PTP), IEEE 1588 describes a method that enables precise synchronization of clocks in the network.

PTP permits synchronization with an accuracy of a few 100 ns. PTP uses Multicasts for the synchronization messages, which keeps the network load low.

4.4.1 Types of clocks

PTP defines the roles of “master” and “slave” for the clocks in the network:

- ▶ A master clock (reference time source) distributes its time.
- ▶ A slave clock synchronizes itself with the timing signal received from the master clock.

Boundary clock

The transmission time (latency) in routers and switches has a measurable effect on the precision of the time transmission. To correct such inaccuracies, PTP defines what are known as boundary clocks.

In a network segment, a boundary clock is the reference time source (master clock) to which the subordinate slave clocks synchronize. Typically routers and switches take on the role of boundary clock.

The boundary clock in turn obtains the time from a higher-level reference time source (Grandmaster).

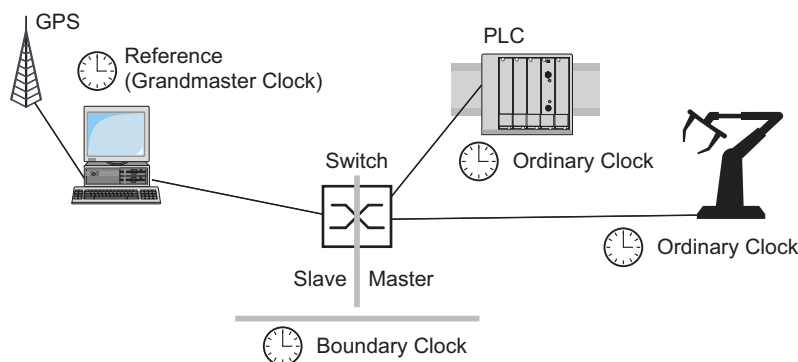

Figure 19: Position of the boundary clock in a network

Transparent Clock

Switches typically take on the *Transparent Clock* role to enable high accuracy across the cascades. The *Transparent Clock* is a *Slave* clock that corrects its own transmission time when it forwards received synchronization messages.

Ordinary Clock

PTP designates the clock in a end device as an *Ordinary Clock*. An *Ordinary Clock* functions either as a master clock or slave clock.

4.4.2 Best Master Clock algorithm

The devices participating in PTP designate a device in the network as a reference time source (Grandmaster). Here the *Best Master Clock* algorithm is used, which determines the accuracy of the clocks available in the network.

The *Best Master Clock* algorithm evaluates the following criteria:

- ▶ *Priority 1*
- ▶ *Clock class*
- ▶ *Clock accuracy*
- ▶ *Clock variance*
- ▶ *Priority 2*

The algorithm first evaluates the value in the *Priority 1* field of the participating devices. The device with the numerically lowest *Priority 1* value becomes the reference time source (*Grandmaster*). When the value is the same for multiple devices, the algorithm takes the next criterion. When this is also the same, it takes the next criterion after this one. If these values are the same for multiple devices, then the numerically lowest *Clock identity* value decides which device becomes the reference time source (*Grandmaster*).

In the settings of the boundary clock, the device lets you individually specify the values for *Priority 1* and *Priority 2*. This lets you influence which device will be the reference time source (*Grandmaster*) in the network.

4.4.3 Delay measurement

The delay of the synchronization messages between the devices affects the accuracy. The delay measurement lets the devices take into account the average delay.

PTP version 2 offers the following methods for delay measurement:

- ▶ *e2e* (End to End)
The slave clock measures the delay of synchronization messages to the master clock.
- ▶ *e2e-optimized*
The slave clock measures the delay of synchronization messages to the master clock. This method is available only for transparent clocks. The device forwards the synchronization messages sent using Multicast only to the master clock, keeping the network load low. When the device receives a synchronization message from another master clock, it forwards the synchronization messages only to this new port. When the device knows no master clock, it forwards synchronization messages to every port.
- ▶ *p2p* (Peer to Peer)
The slave clock measures the delay of synchronization messages to the master clock. In addition, the master clock measures the delay to each slave clock, even across blocked ports. This requires that the master and slave clock support Peer-to-Peer (*p2p*). In case of interruption of a redundant ring, for example, the slave clock becomes the master clock and the master clock becomes the slave clock. This switch occurs without loss of precision, because the clocks already know the delay in the other direction.

4.4.4 PTP domains

The device transmits synchronization messages only from and to devices in the same PTP domain. The device lets you set the domain for the boundary clock and for the transparent clock individually.

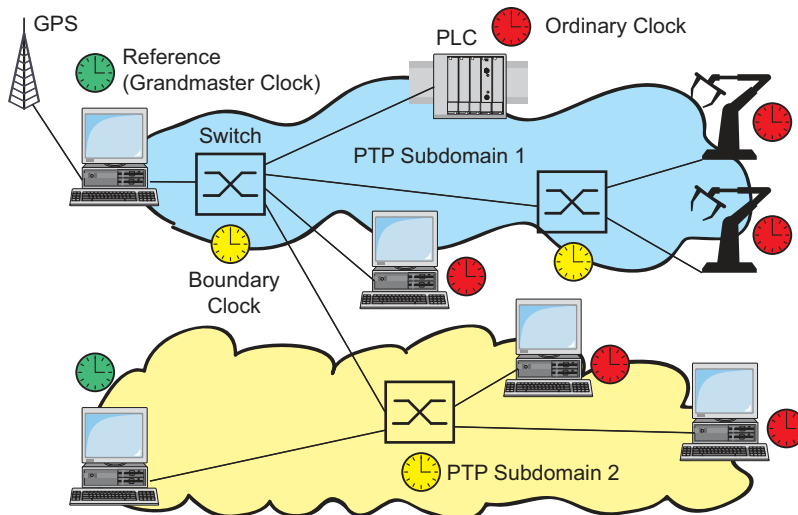

Figure 20: Example of PTP domains

4.4.5 Using PTP

To synchronize the clocks precisely with PTP, only use switches with a boundary clock or transparent clock as nodes.

Perform the following steps:

- To gain an overview of the distribution of clocks, draw a network plan with the devices involved in PTP.
- Specify the role for each participating switch (boundary clock or transparent clock). In the device, this setting is called *PTP mode*.

Table 18: Possible settings for PTP mode

PTP mode	Application
<i>v2-boundary-clock</i>	As a boundary clock, the device distributes synchronization messages to the slave clocks in the subordinate network segment. The boundary clock in turn obtains the time from a higher-level reference time source (Grandmaster).
<i>v2-transparent-clock</i>	As a transparent clock, the device forwards received synchronization messages after they have been corrected by the delay of the transparent clock.

- Enable PTP on each participating switch. PTP then sets itself up on a largely automatic basis.
- Enable PTP on the end devices.
- The device lets you influence which device in the network becomes the reference clock (Grandmaster). Therefore, change the default value in the *Priority 1* and *Priority 2* fields for the *Boundary Clock*.

4.5 Synchronizing time in the network with 802.1AS

Some LAN-based applications require the internal clocks of the participating devices to be precisely synchronized. The IEEE 802.1AS-2020 protocol describes a method that enables precise synchronization of the clocks of time-aware devices in the network.

The IEEE 802.1AS-2020 protocol is based on Precision Time Protocol (PTP) and is tailored for Ethernet-based Time-Sensitive Networking (TSN) environments.

The [802.1AS](#) function in the device permits synchronization with an accuracy of a few 100 ns. The [802.1AS](#) function uses Multicasts for the synchronization messages, therefore keeping the network load low.

4.5.1 Instances and domains

Each *PTP domain* operates independently and helps ensure that the clocks of the time-aware devices within the *PTP domain* are synchronized. The devices are synchronized to the reference time source (*Grandmaster*) of the respective domain. You can use different domains to synchronize the time for different groups of devices within a network.

The device can be part of multiple *PTP domains*. In the device, the [802.1AS](#) function supports 2 instances: *Instance 0* and *Instance 1*, each operating within separate *PTP domains*.

You set up each instance separately:

- *Instance 0*
for synchronizing device clocks and transmitting time synchronization messages
- *Instance 1*
only for transmitting time synchronization messages

4.5.2 Best Master Clock algorithm

The devices participating in PTP designate a device in the *PTP domain* as a reference time source (*Grandmaster*). The *Best Master Clock* algorithm is used to determine the accuracy of the clocks available in the *PTP domain*.

The *Best Master Clock* algorithm evaluates the following criteria for each participating device:

- *Priority 1*
- *Clock class*
- *Clock accuracy*
- *Clock variance*
- *Priority 2*
- *Clock identity*

The algorithm first evaluates the value in the *Priority 1* field of the participating devices. The device with the numerically lowest value in the *Priority 1* field is designated as the reference time source (*Grandmaster*). If the value is the same for multiple devices, then the algorithm takes the next criterion. If this is also the same, then the algorithm takes the next criterion after this one. If these values are the same for multiple devices, then the numerically lowest value in the *Clock identity* field decides which device is designated as the reference time source (*Grandmaster*). The value in the *Clock identity* field is based on the device MAC address which is supposed to be globally unique. The value in the *Clock identity* field serves as the final tie-break for the algorithm.

4.5.3 Enabling the 802.1AS function

The *802.1AS* function and the *PTP* function cannot be enabled simultaneously on the device.

In the default setting, the *802.1AS* function is disabled. Enabling the *802.1AS* function lets time-aware devices within the same *PTP domain* synchronize.

Perform the following steps on each device within the same *PTP domain*:

- Open the *Time > 802.1AS > Global* dialog.
- Enable the *802.1AS* function globally.
Select the *On* radio button in the *Operation* frame.
- Apply the settings temporarily. To do this, click the button.
- Open the *Time > 802.1AS > Port* dialog.
- Enable the *802.1AS* function for *Instance 0*.
Select the *Instance 0* tab.
Select the *On* radio button in the *Operation* frame.
- Enable the *802.1AS* function on the interface.
In the *Active* column of the desired interface, mark the checkbox.
- Apply the settings temporarily. To do this, click the button.

enable	To change to the Privileged EXEC mode.
configure	To change to the Configuration mode.
dot1as operation enable	To enable the <i>802.1AS</i> function globally.
dot1as instance 0 operation enable	To enable the <i>802.1AS</i> function for <i>Instance 0</i> .
interface 1/1	To change to the interface configuration mode of interface <i>1/1</i> .
dot1as instance 0 operation enable	To enable the <i>802.1AS</i> function on interface <i>1/1</i> for <i>Instance 0</i> .
show dot1as data-port-set instance 0 port 1/1	To check the status of <i>Instance 0</i> on interface <i>1/1</i> .
show dot1as current instance 0	To check the status of <i>Instance 0</i> .
exit	To change to the Configuration mode.
exit	To change to the Privileged EXEC mode.

To save the settings permanently, see section “[Saving a configuration profile](#)” on page 97.

4.5.4 Disabling the 802.1AS function globally

When disabling the *802.1AS* function globally, you disable time synchronization for both instances and for the respective ports allocated to them. This disables time synchronization on the instance and port levels even if the *802.1AS* function is enabled on the instances and on the individual ports.

Perform the following steps on each device within the same *PTP domain*:

- Open the *Time > 802.1AS > Global* dialog.
- Disable the *802.1AS* function globally.
Select the *Off* radio button in the *Operation* frame.
- Apply the settings temporarily. To do this, click the button.

enable	To change to the Privileged EXEC mode.
configure	To change to the Configuration mode.
dot1as operation disable	To disable the <i>802.1AS</i> function globally.
exit	To change to the Privileged EXEC mode.

To save the settings permanently, see section “[Saving a configuration profile](#)” on page 97.

4.5.5 Disabling the 802.1AS function for an instance

You disable the *802.1AS* function on an instance, for example, in the following situations:

- to disable time synchronization for the ports allocated to the respective instance in one go
- to reallocate a port from one instance to another instance
- to reduce the network load generated by the transmission of synchronization messages

Perform the following steps:

- Open the *Time > 802.1AS > Port* dialog.
- Disable the *802.1AS* function for *Instance 0*.
Select the *Instance 0* tab.
Select the *Off* radio button in the *Operation* frame.
- Apply the settings temporarily. To do this, click the button.

enable	To change to the Privileged EXEC mode.
configure	To change to the Configuration mode.
dot1as instance 0 operation disable	To disable the <i>802.1AS</i> function for <i>Instance 0</i> .
exit	To change to the Privileged EXEC mode.

To save the settings permanently, see section “[Saving a configuration profile](#)” on page 97.

4.5.6 Disabling the 802.1AS function on a port

You disable the *802.1AS* function on an individual port, for example, in the following situations:

- When the port is connected to a device that is not time-aware and, therefore, does not require time synchronization.
- When you allocate the port to another instance. Before you allocate a port to another instance, we recommend you disable the *802.1AS* function on the port.

Perform the following steps:

- Open the *Time > 802.1AS > Port* dialog. Select the *Instance 0* tab.
- Deactivate the *802.1AS* function on interface *1/1*. Unmark the checkbox in the *Active* column.
- Apply the settings temporarily. To do this, click the button.

enable	To change to the Privileged EXEC mode.
configure	To change to the Configuration mode.
interface 1/1	To change to the interface configuration mode of interface <i>1/1</i> .
dot1as instance 0 operation disable	To disable the <i>802.1AS</i> function on interface <i>1/1</i> for <i>Instance 0</i> .
exit	To change to the Configuration mode.
exit	To change to the Privileged EXEC mode.

To save the settings permanently, see section “[Saving a configuration profile](#)” on page 97.

5 Managing configuration profiles

If you change the settings of the device during operation, then the device stores the changes in its memory (*RAM*). After a reboot the settings are lost.

To keep the changes after a reboot, the device lets you save the settings in a configuration profile in the non-volatile memory (*NVM*). To make it possible to quickly switch to other settings, the non-volatile memory offers storage space for multiple configuration profiles.



If an external memory is connected, then the device automatically saves a copy of the configuration profile in the external memory (*ENVM*). You can disable this function.

5.1 Detecting changed settings

The device stores changes made to settings during operation in its volatile memory (*RAM*). The configuration profile in the non-volatile memory (*NVM*) remains unchanged until you save the changed settings explicitly. Until then, the configuration profiles in memory and non-volatile memory are different. The device helps you recognize changed settings.

5.1.1 Volatile memory (RAM) and non-volatile memory (NVM)

You can recognize if the settings in the volatile memory (*RAM*) differ from the settings of the "selected" configuration profile in the non-volatile memory (*NVM*). To do this, perform the following steps:

- Check the banner of the Graphical User Interface:
 - When the  icon is visible, the settings differ.
 - When no  icon is visible, the settings match.

Or:

- Open the *Basic Settings > Load/Save* dialog.
- Check the status of the checkbox in the *Information* frame:
 - When the checkbox is marked, the settings match.
 - When the checkbox is unmarked, the settings differ.

```
show config status
Configuration Storage sync State
-----
running-config to NV.....out of sync
...
```

5.1.2 External memory (ACA) and non-volatile memory (NVM)

You can recognize if the settings copied to the external memory (ACA) differ from the settings of the configuration profile in the non-volatile memory (NVM). To do this, perform the following steps:

- Open the *Basic Settings > Load/Save* dialog.
- Check the status of the checkbox in the *Information* frame:
 - When the checkbox is marked, the settings match.
 - When the checkbox is unmarked, the settings differ.

```
show config status
Configuration Storage sync State
-----
...
NV to ACA.....out of sync
...
```

5.2 Saving the settings

5.2.1 Saving the configuration profile in the device

If you change the settings of the device during operation, then the device stores the changes in its memory (RAM). To keep the changes after a reboot, save the configuration profile in the non-volatile memory (NVM).

Saving a configuration profile

The device stores the settings in the "selected" configuration profile in the non-volatile memory (NVM).

Perform the following steps:

- Open the *Basic Settings > Load/Save* dialog.
- Verify that the required configuration profile is "Selected".
You can recognize the "Selected" configuration profile because the checkbox in the *Selected* column is marked.
- Click the  button.

show config profiles nvm

To display the configuration profiles contained in the non-volatile memory (nvm).

enable

To change to the Privileged EXEC mode.

save

To save the settings in the non-volatile memory (nvm) in the "Selected" configuration profile.

Copying settings to a configuration profile

The device lets you store the settings saved in the memory (RAM) in a configuration profile other than the "selected" configuration profile. In this way the device adds a configuration profile in the non-volatile memory (NVM) or overwrites an existing one.

Perform the following steps:

- Open the *Basic Settings > Load/Save* dialog.
- Click the  button and then the *Save as..* item.
The dialog displays the *Save as..* window.
- In the *Name* field, change the name of the configuration profile. If you keep the proposed name, the device will overwrite an existing configuration profile of the same name.
- Click the *Ok* button.

The new configuration profile is designated as "Selected".

```
show config profiles nvm  
  
enable  
  
copy config running-config nvm profile  
<string>
```

To display the configuration profiles contained in the non-volatile memory (*nvm*).

To change to the Privileged EXEC mode.

To save the current settings in the configuration profile named *<string>* in the non-volatile memory (*nvm*). If present, the device overwrites a configuration profile of the same name. The new configuration profile is designated as "Selected".

Selecting a configuration profile

When the non-volatile memory (*NVM*) contains multiple configuration profiles, you have the option to select any configuration profile there. The device stores the settings in the "Selected" configuration profile. During the system startup, the device loads the settings of the "Selected" configuration profile into the memory (*RAM*).

Perform the following steps:

- Open the *Basic Settings > Load/Save* dialog.

The table displays the configuration profiles present in the device. You can recognize the "Selected" configuration profile because the checkbox in the *Selected* column is marked.

- Select the table row of the desired configuration profile stored in the non-volatile memory (*NVM*).
- Click the  button and then the *Select* item.

In the *Selected* column, the checkbox of the configuration profile is now *marked*.

```
enable  
  
show config profiles nvm  
  
configure  
  
config profile select nvm 1  
  
save
```

To change to the Privileged EXEC mode.

To display the configuration profiles contained in the non-volatile memory (*nvm*).

To change to the Configuration mode.

To select the configuration profile. Take note of the adjacent name of the configuration profile.

To save the settings in the non-volatile memory (*nvm*) in the "Selected" configuration profile.

5.2.2 Saving the configuration profile in the external memory

When an external memory is connected and you save a configuration profile, the device automatically saves a copy in the *Selected external memory*. In the default setting, the function is enabled. You can disable this function.

Perform the following steps:

- Open the *Basic Settings > External Memory* dialog.
- Mark the checkbox in the *Backup config when saving* column to enable the device to automatically save a copy in the external memory during the saving process.
- To deactivate the function, unmark the checkbox in the *Backup config when saving* column.
- Apply the settings temporarily. To do this, click the button.

enable	To change to the Privileged EXEC mode.
configure	To change to the Configuration mode.
config envm config-save sd	To enable the function. When you save a configuration profile, the device saves a copy in the external memory. <i>sd</i> = External SD memory
no config envm config-save sd	To disable the function. The device does not save a copy in the external memory. <i>sd</i> = External SD memory
save	To save the settings in the non-volatile memory (<i>nvm</i>) in the "Selected" configuration profile.

5.2.3 Backing up the configuration profile on a remote server

The device lets you automatically back up the configuration profile to a remote server. The prerequisite is that you activate the function before you save the configuration profile.

After you save the configuration profile in the non-volatile memory (*NVM*), the device sends a copy to the specified URL.

Perform the following steps:

- Open the *Basic Settings > Load/Save* dialog.
In the *Backup config on a remote server when saving* frame, perform the following steps:
- In the *URL* field, specify the server as well as the path and file name of the backed up configuration profile.
- Click the *Set credentials* button.
The dialog displays the *Credentials* window.
- Enter the login credentials needed to authenticate on the remote server.
- In the *Operation* option list, enable the function.
- Apply the settings temporarily. To do this, click the button.

enable	To change to the Privileged EXEC mode.
show config remote-backup	To check the status of the function.
configure	To change to the Configuration mode.
config remote-backup destination {URL}	To enter the destination URL for the configuration profile backup (max. 128 chars).
config remote-backup username {username}	To enter the user name to authenticate on the remote server (max. 128 chars).
config remote-backup password {password}	To enter the password to authenticate on the remote server (max. 128 chars).
config remote-backup operation	To enable the function.

If the transfer to the remote server is unsuccessful, then the device logs this event in the System Log.

5.2.4 Exporting a configuration profile

The device lets you save a configuration profile to a server as an XML file. If you use the Graphical User Interface, then you have the option to save the XML file directly to your PC.

Prerequisites:

- ▶ To save the file on a server, you need a server available on the network.
- ▶ To save the file to an SCP or SFTP server, you also need the user name and password for accessing this server.
- ▶ Remember to make the SCP or SFTP server known to the device before the device accesses the server for the first time. See the [Device Security > SSH Known Hosts](#) dialog.

Perform the following steps:

- Open the [Basic Settings > Load/Save](#) dialog.
- Select the table row of the desired configuration profile.

Export the configuration profile to your PC. To do this, perform the following steps:

- Click the link in the [Profile name](#) column.
The configuration profile is downloaded and saved as an XML file on your PC.

Export the configuration profile to a remote server. To do this, perform the following steps:

- Click the  button and then the *Export...* item.
The dialog displays the *Export...* window.
- In the *URL* field, specify the file URL on the remote server:
 - To save the file on an FTP server, specify the URL for the file in the following form:
ftp://<user>:<password>@<IP address>[:port]/<file name>
This option is not recommended if you transmit data over untrusted networks.
 - To save the file on a TFTP server, specify the URL for the file in the following form:
tftp://<IP address>/<path>/<file name>
This option is not recommended if you transmit data over untrusted networks.
 - To save the file on an SCP or SFTP server, specify the URL for the file in one of the following forms:
scp:// or sftp://<user>:<password>@<IP address>/<path>/<file name>
scp:// or sftp://<IP address>/<path>/<file name>
Remember to make the SCP or SFTP server known to the device before the device accesses the server for the first time. See the *Device Security > SSH Known Hosts* dialog.
When you click the *Ok* button, the device displays the *Credentials* window. There you enter *User name* and *Password* to log into the server.
- Click the *Ok* button.
The configuration profile is now saved as an XML file in the specified location.

```
show config profiles nvm
```

To display the configuration profiles contained in the non-volatile memory (*nvm*).

```
enable
```

To change to the Privileged EXEC mode.

```
copy config running-config remote tftp://  
<IP_address>/ <path>/<file_name>
```

To save the current settings on a TFTP server. This option is not recommended if you transmit data over untrusted networks.

```
copy config nvm remote sftp://  
<user_name>:<password>@<IP_address>/  
<path>/<file_name>
```

To save the “Selected” configuration profile in the non-volatile memory (*nvm*) on a SFTP server.

```
copy config nvm profile config3  
remote tftp://<IP_address>/ <path>/  
<file_name>
```

To save the configuration profile *config3* in the non-volatile memory (*nvm*) on a TFTP server. This option is not recommended if you transmit data over untrusted networks.

```
copy config nvm profile config3  
remote ftp://<IP_address>[:port]/<path>/  
<file_name>
```

To save the configuration profile *config3* in the non-volatile memory (*nvm*) on an FTP server. This option is not recommended if you transmit data over untrusted networks.

5.3 Loading settings

If you save multiple configuration profiles in the memory, then you have the option to load a different configuration profile.

5.3.1 Activating a configuration profile

The non-volatile memory of the device can contain multiple configuration profiles. If you activate a configuration profile stored in the non-volatile memory (*NVM*), then you immediately change the settings in the device. The device does not require a reboot.

Perform the following steps:

- Open the *Basic Settings > Load/Save* dialog.
- Select the table row of the desired configuration profile.
- Click the  button and then the *Activate* item.

The device copies the settings to the memory (*RAM*) and disconnects from the Graphical User Interface. The device immediately uses the settings of the configuration profile.

- Reload the Graphical User Interface.
- Log in again.

In the *Selected* column, the checkbox of the configuration profile that was activated before is marked.

```
show config profiles nvm
```

To display the configuration profiles contained in the non-volatile memory (*nvm*).

```
enable
```

To change to the Privileged EXEC mode.

```
copy config nvm profile config3 running-config
```

To activate the settings of the configuration profile *config3* in the non-volatile memory (*nvm*).

The device copies the settings into the volatile memory and disconnects the connection to the Command Line Interface. The device immediately uses the settings of the configuration profile *config3*.

5.3.2 Loading the configuration profile from the external memory

If an external memory is connected, then the device loads a configuration profile from the external memory during the system startup automatically. The device lets you save these settings in a configuration profile in non-volatile memory.

When the external memory contains the configuration profile of an identical device, you have the possibility to transfer the settings from one device to another.

Perform the following steps:

- Verify that the device loads a configuration profile from the external memory during the system startup.
In the default setting, the function is enabled. If the function is disabled, enable it again as follows:

- Open the *Basic Settings > External Memory* dialog.
- In the *Config priority* column, select the value *first*.
- Apply the settings temporarily. To do this, click the button.

enable	To change to the Privileged EXEC mode.															
configure	To change to the Configuration mode.															
config envm load-priority sd first	To enable the function. During the system startup, the device loads a configuration profile from the external memory. <i>sd</i> = External SD memory															
show config envm settings	To display the settings of the external memory (<i>envm</i>).															
<table border="0" style="width: 100%;"> <thead> <tr> <th style="text-align: left;">Type</th> <th style="text-align: left;">Status</th> <th style="text-align: left;">Auto Update</th> <th style="text-align: left;">Save Config</th> <th style="text-align: left;">Config Load Prio</th> </tr> <tr> <th colspan="5">-----</th> </tr> </thead> <tbody> <tr> <td>sd</td> <td>ok</td> <td>[x]</td> <td>[x]</td> <td>first</td> </tr> </tbody> </table>		Type	Status	Auto Update	Save Config	Config Load Prio	-----					sd	ok	[x]	[x]	first
Type	Status	Auto Update	Save Config	Config Load Prio												

sd	ok	[x]	[x]	first												
save	To save the settings in a configuration profile in the non-volatile memory (<i>NVM</i>) of the device.															

Using the Command Line Interface, the device lets you copy the settings from the external memory directly into the non-volatile memory (*NVM*).

show config profiles nvm	To display the configuration profiles contained in the non-volatile memory (<i>nvm</i>).
enable	To change to the Privileged EXEC mode.
copy config envm profile config3 nvm	To copy the configuration profile <i>config3</i> from the external memory (<i>envm</i>) to the non-volatile memory (<i>nvm</i>).

The device can also automatically load a configuration profile from a script file during the system startup.

Prerequisites:

- ▶ Verify that the external memory is connected before you start the device.
- ▶ The root directory of the external memory contains a text file *startup.txt* with the content *script=<file_name>*. The placeholder *<file_name>* represents the script file that the device executes during the system startup.
- ▶ The root directory of the external memory contains the script file. You have the option to save the script with a user-specified name. Save the file with the file extension *.cli*.

Note: Verify that the script saved in the external memory is not empty. If the script is empty, then the device loads the next configuration profile as per the configuration priority settings.

After applying the script, the device automatically saves the configuration profile from the script file as an XML file in the external memory. When you type the appropriate command into the script file, you have the option to disable this function:

no config envm config-save sd

The device does not save a copy in the external SD memory.

When the script file contains an incorrect command, the device does not apply this command during the system startup. The device logs the event in the System Log.

5.3.3 Importing a configuration profile

The device lets you import from a server a configuration profile saved as an XML file. If you use the Graphical User Interface, then you can import the XML file directly from your PC.

Prerequisites:

- ▶ To import a file from a server, you need a server available on the network.
- ▶ To import a file from an SCP or SFTP server, you also need the user name and password for accessing this server.
- ▶ Remember to make the SCP or SFTP server known to the device before the device accesses the server for the first time. See the [Device Security > SSH Known Hosts](#) dialog.

Perform the following steps:

- Open the [Basic Settings > Load/Save](#) dialog.
- Click the  button and then the [Import...](#) item.
The dialog displays the [Import...](#) window.
- From the [Select source](#) drop-down list, select the location from where the device imports the configuration profile.
 - [PC/URL](#)
The device imports the configuration profile from the local PC or from a remote server.
 - [External memory](#)
The device imports the configuration profile from the external memory.

Import the configuration profile from the local PC or from a remote server. To do this, perform the following steps:

- Import the configuration profile:
 - If the file is on an FTP server, then specify the URL in the following form:
ftp://<user>:<password>@<IP address>[:port]/<file name>
This option is not recommended if you transmit data over untrusted networks.
 - If the file is on a TFTP server, then specify the URL in the following form:
tftp://<IP address>/<path>/<file name>
This option is not recommended if you transmit data over untrusted networks.
 - If the file is on an SCP or SFTP server, then specify the URL in one of the following forms:
scp:// or sftp://<IP address>/<path>/<file name>
When you click the *Start* button, the device displays the *Credentials* window. There you enter *User name* and *Password* to log into the server.
scp:// or sftp://<user>:<password>@<IP address>/<path>/<file name>
Remember to make the SCP or SFTP server known to the device before the device accesses the server for the first time. See the *Device Security > SSH Known Hosts* dialog.
- In the *Destination* frame, specify where the device saves the imported configuration profile:
 - In the *Profile name* field, specify the name under which the device saves the configuration profile.
 - In the *Storage* field, specify the storage location for the configuration profile.
- Click the *Ok* button.

The device copies the configuration profile into the specified memory.

If you specified the value *ram* in the *Destination* frame, then the device disconnects the Graphical User Interface and uses the settings immediately.

Import the configuration profile from the external memory. To do this, perform the following steps:

- In the *Import profile from external memory* frame, select the name of the configuration profile to be imported from the *Profile name* drop-down list.
The prerequisite is that the external memory contains an exported configuration profile.
- In the *Destination* frame, specify where the device saves the imported configuration profile:
 - In the *Profile name* field, specify the name under which the device saves the configuration profile.
- Click the *Ok* button.

The device copies the configuration profile into the non-volatile memory (*NVM*) of the device.

If you specified the value *ram* in the *Destination* frame, then the device disconnects the Graphical User Interface and uses the settings immediately.

```
enable

copy config remote ftp://
<IP_address>[:port]/<path>/<file_name>
running-config

copy config remote tftp://<IP_address>/
<path>/<file_name> running-config

copy config remote sftp://
<user name>:<password>@<IP_address>/
<path>/<file_name> running-config

copy config remote ftp://
<IP_address>[:port]/<path>/<file_name>
nvm profile config3

copy config remote tftp://<IP_address>/
<path>/<file_name> nvm profile config3
```

To change to the Privileged EXEC mode.

To import and activate the settings of a configuration profile saved on an FTP server. This option is not recommended if you transmit data over untrusted networks. The device copies the settings into the volatile memory and disconnects the connection to the Command Line Interface. The device immediately uses the settings of the imported configuration profile.

To import and activate the settings of a configuration profile saved on a TFTP server. This option is not recommended if you transmit data over untrusted networks. The device copies the settings into the volatile memory and disconnects the connection to the Command Line Interface. The device immediately uses the settings of the imported configuration profile.

To import and activate the settings of a configuration profile saved on a SFTP server. The device copies the settings into the volatile memory and disconnects the connection to the Command Line Interface. The device immediately uses the settings of the imported configuration profile.

To import the settings of a configuration profile saved on an FTP server and save the settings in the configuration profile `config3` in the non-volatile memory (`nvm`). This option is not recommended if you transmit data over untrusted networks.

To import the settings of a configuration profile saved on a TFTP server and save the settings in the configuration profile `config3` in the non-volatile memory (`nvm`). This option is not recommended if you transmit data over untrusted networks.

Note: Upgrading from Classic to HiOS? Convert your device configuration files using our online tool: <https://convert.hirschmann.com>

5.4 Resetting the device to the default setting

If you reset the settings in the device to the delivery state, then the device deletes the configuration profiles in the volatile memory and in the non-volatile memory.

If an external memory is connected, then the device also deletes the configuration profiles saved in the external memory.

The device then reboots and loads the factory settings.

5.4.1 Using the Graphical User Interface or Command Line Interface

Perform the following steps:

- Open the *Basic Settings > Load/Save* dialog.
- Click the  button, then *Back to factory...*
The dialog displays a message.
- Click the *Ok* button.

The device deletes the configuration profiles in the memory (RAM) and in the non-volatile memory (NVM).

If an external memory is connected, then the device also deletes the configuration profiles saved in the external memory.

After a brief period, the device restarts and loads the delivery settings.

enable

clear factory

To change to the Privileged EXEC mode.

To delete the configuration profiles from the non-volatile memory and from the external memory. If an external memory is connected, then the device also deletes the configuration profiles saved in the external memory.

After a brief period, the device restarts and loads the delivery settings.

5.4.2 Using the System Monitor

Perform the following steps:

- To change to the System Monitor, proceed as described in chapter “Starting the System Monitor” on page 38.
- To change from the main menu to the Manage configurations menu, press the <4> key.
- To execute the Clear configs and boot params command, press the <1> key.
- To load the factory settings, press the <Enter> key.

The device deletes the configuration profiles in the memory (RAM) and in the non-volatile memory (NVM).

If an external memory is connected, then the device also deletes the configuration profiles saved in the external memory.

- To change to the main menu, press the <q> key.
- To reboot the device with factory settings, press the <q> key.

6 Updating the device software

Hirschmann is continually working on improving and developing their software. Check regularly if there is an updated version of the device software that provides you with additional benefits. You find information and software downloads on the Hirschmann product pages on the Internet at www.hirschmann.com.

The device gives you the following options to update the device software:

- ▶ [Loading a previous device software version](#)
- ▶ [Software update from the PC](#)
- ▶ [Software update from a server](#)
- ▶ [Software update from the external memory](#)

Note: The device settings are kept after you update the device software.

You see the version of the installed device software in the login dialog of the Graphical User Interface.

To display the version of the installed device software when you are already logged into the device management, perform the following steps:

- Open the [Basic Settings > Software](#) dialog.
The [Running version](#) field displays the version number and creation date of the currently running device software that the device loaded during the last system startup.

enable

show system info

To change to the Privileged EXEC mode.

To display the system information such as the version number and creation date of the currently running device software that the device loaded during the last system startup.

6.1 Loading a previous device software version

The device lets you replace the device software with a previous version. The basic settings in the device are kept after replacing the device software.

Note: Only the settings for functions which are available in the newer device software version are lost.

6.2 Software update from the PC

The device lets you update the device software, if a suitable device software image is saved on a storage medium which is accessible from your PC.

To remain logged in to the device management during the software update, move the mouse pointer occasionally. As an alternative, before you start the software update, specify a sufficiently high value in the *Device Security > Management Access > Web* dialog, *Web interface session timeout [min]* field.

Perform the following steps:

- Navigate to the folder where the device software image is saved.
- Open the *Basic Settings > Software* dialog.
- Drag and drop the file into the  area. As an alternative, click in the area to select the file.
- Start the software update. To do this, click the *Start* button.
 - The device transfers the previously used device software to the backup memory.
 - The device transfers the selected file to the flash memory, replacing the previously used device software.

As soon as the update procedure is completed successfully, the device displays a success notification.

During the next startup, the device boots with the device software that you have transferred.

6.3 Software update from a server

The device lets you update its software if you have access to a server where a suitable device software image is saved.

The device gives you the following options to update the device software:

- ▶ [Software update from an FTP server](#)
- ▶ [Software update from a TFTP server](#)
- ▶ [Software update from an SFTP server](#)
- ▶ [Software update from an SCP server](#)

To remain logged in to the device management during the software update, move the mouse pointer occasionally. As an alternative, before you start the software update, specify a sufficiently high value in the [Device Security > Management Access > Web](#) dialog, [Web interface session timeout \[min\]](#) field.

6.3.1 Software update from an FTP server

This option lets you update the device software image from an FTP server. This option is not recommended if you transmit data over untrusted networks.

The prerequisite is that the access role [administrator](#) is assigned to the user account you use to perform the actions on the device.

Perform the following steps:

- Open the [Basic Settings > Software](#) dialog.
- In the [Software update](#) frame, [URL](#) field, specify the URL for the device software image using the following format:
`ftp://user:password@IP_address:port/path/to/software_image.bin`
You can also specify the URL without the user name and password. In this case, enter them in the [Credentials](#) window after clicking the [Start](#) button.
- Click the [Start](#) button.
 - The device transfers the previously used device software to the backup memory.
 - The device transfers the selected file to the flash memory, replacing the previously used device software.As soon as the update procedure is completed successfully, the device displays an information that the device software was successfully updated.
During the next startup, the device boots with the device software that you have transferred.

```
enable
copy firmware remote ftp://
user:password@10.0.1.159:21/path/to/
software_image.bin system
```

To change to the Privileged EXEC mode.

To transfer the device software image from an FTP server to the flash memory of the device.

- `copy firmware remote`
To copy the device software image from a remote location.
- `ftp://user:password@10.0.1.159:21/path/to/software_image.bin`
URL of the FTP server where the device software image file is saved.
You can also specify the URL without the user name and password. In this case, the device will prompt you to enter the missing information afterwards.
 - `ftp://`
Protocol for the file transfer
 - `user`
User account name of the FTP server
 - `password`
User account password
 - `10.0.1.159`
IP address of the FTP server
 - `21`
Default port for FTP
 - `/path/to/`
The path to the device software image on the FTP server
 - `software_image.bin`
Name of the device software image
- `system`
To transfer the copied device software image to the flash memory.

6.3.2 Software update from a TFTP server

This option lets you update the device software image from a TFTP server. This option is not recommended if you transmit data over untrusted networks.

The prerequisite is that the access role `administrator` is assigned to the user account you use to perform the actions on the device.

Perform the following steps:

- Open the [Basic Settings > Software](#) dialog.
- In the [Software update](#) frame, [URL](#) field, specify the URL for the device software image using the following format:
tftp://IP_address/path/to/software_image.bin
- Click the [Start](#) button.
 - The device transfers the previously used device software to the backup memory.
 - The device transfers the selected file to the flash memory, replacing the previously used device software.

As soon as the update procedure is completed successfully, the device displays an information that the device software was successfully updated.
During the next startup, the device boots with the device software that you have transferred.

enable

```
copy firmware remote tftp://0.0.1.159/
path/to/software_image.bin system
```

To change to the Privileged EXEC mode.

To transfer the device software image from a TFTP server to the flash memory of the device.

- copy firmware remote
To copy the device software image from a remote location.
- tftp://10.0.1.159/path/to/software_image.bin
URL of the TFTP server where the device software image is saved.
 - tftp://
Protocol for the file transfer
 - 10.0.1.159
IP address of the TFTP server
 - /path/to/
The path to the device software image on the TFTP server
 - software_image.bin
Name of the device software image
- system
To transfer the copied device software image to the flash memory.

6.3.3 Software update from an SFTP server

This option lets you update the device software image from an SFTP server.

Prerequisites:

- The access role [administrator](#) is assigned to the user account you use to perform the actions on the device.
- The SFTP server is known to the device. See the [Device Security > SSH Known Hosts](#) dialog.

Perform the following steps:

- Open the *Basic Settings > Software* dialog.
- In the *Software update* frame, *URL* field, specify the URL for the device software image using the following format:
sftp://user:password@IP_address/path/to/software_image.bin
You can also specify the URL without the user name and password. In this case, enter them in the *Credentials* window after clicking the *Start* button.
- Click the *Start* button.
 - The device transfers the previously used device software to the backup memory.
 - The device transfers the selected file to the flash memory, replacing the previously used device software.As soon as the update procedure is completed successfully, the device displays an information that the device software was successfully updated.
During the next startup, the device boots with the device software that you have transferred.

enable

```
copy firmware remote sftp://  
user:password@10.0.1.159:21/path/to/  
software_image.bin system
```

To change to the Privileged EXEC mode.

To transfer the device software image from an SFTP server to the flash memory of the device.

- copy firmware remote
To copy the device software image from a remote location.
- sftp://user:password@10.0.1.159:21/path/to/
software_image.bin
URL of the SFTP server where the device software image is saved.
You can also specify the URL without the user name and password. In this case, the device will prompt you to enter the missing information afterwards.
 - sftp://
Protocol for the file transfer
 - user
User account name of the SFTP server
 - password
User account password
 - 10.0.1.159
IP address of the SFTP server
 - /path/to/
The path to the device software image on the SFTP server
 - software_image.bin
Name of the device software image
- system
To transfer the copied device software image to the flash memory.

6.3.4 Software update from an SCP server

This option lets you update the device software image from an SCP server.

Prerequisites:

- The access role `administrator` is assigned to the user account you use to perform the actions on the device.
- The SCP server is known to the device. See the *Device Security > SSH Known Hosts* dialog.

Perform the following steps:

- Open the *Basic Settings > Software* dialog.
- In the *Software update* frame, *URL* field, specify the URL for the device software image using the following format:
`scp://user:password@IP_address/path/to/software_image.bin`
 You can also specify the URL without the user name and password. In this case, enter them in the *Credentials* window after clicking the *Start* button.
- Click the *Start* button.
 - The device transfers the previously used device software to the backup memory.
 - The device transfers the selected file to the flash memory, replacing the previously used device software.
 As soon as the update procedure is completed successfully, the device displays an information that the device software was successfully updated.
 During the next startup, the device boots with the device software that you have transferred.

enable

```
copy firmware remote scp://
user:password@10.0.1.159:21/path/to/
software_image.bin system
```

To change to the Privileged EXEC mode.

To transfer the device software image from an SCP server to the flash memory of the device.

- `copy firmware remote`
 To copy the device software image from a remote location.
- `user:password@10.0.1.159:21/path/to/software_image.bin`
 URL of the SCP server where the device software image is saved.
 You can also specify the URL without the user name and password. In this case, the device will prompt you to enter the missing information afterwards.
 - `scp://`
 Protocol for the file transfer
 - `user`
 User account name of the SCP server
 - `password`
 User account password
 - `10.0.1.159`
 IP address of the SCP server
 - `/path/to/`
 The path to the device software image on the SCP server
 - `software_image.bin`
 Name of the device software image
- `system`
 To transfer the copied device software image to the flash memory.

6.4 Software update from the external memory

6.4.1 Manually—initiated by the administrator

The device lets you update the device software with a few mouse clicks, if a suitable device software image is saved on the external memory.

To remain logged in to the device management during the software update, move the mouse pointer occasionally. As an alternative, before you start the software update, specify a sufficiently high value in the [Device Security > Management Access > Web](#) dialog, [Web interface session timeout \[min\]](#) field.

Perform the following steps:

- Open the [Basic Settings > Load/Save](#) dialog.
- In the [External memory](#) frame, verify that the relevant external memory is selected from the [Selected external memory](#) drop-down list.
- Open the [Basic Settings > Software](#) dialog.
- Mark the table row for which the [File location](#) column displays the value `sd-card`.
- Start the software update. To do this, click the  button.
 - The device transfers the previously used device software to the backup memory.
 - The device transfers the selected file to the flash memory, replacing the previously used device software.As soon as the update procedure is completed successfully, the device displays a success notification.
During the next startup, the device boots with the device software that you have transferred.

6.4.2 Automatically—initiated by the device

When the following files are located in the external memory during the system startup, the device updates the device software automatically:

- ▶ the device software image
- ▶ a text file `startup.txt` with the content `autoUpdate=<software_image_file_name>.bin`

The prerequisite is that in the [Basic Settings > External Memory](#) dialog, you mark the checkbox in the [Software auto update](#) column. This is the default setting in the device.

Perform the following steps:

- Transfer the new device software image into the main directory of the external memory. Use only a device software image suitable for the device.
- Create a text file `startup.txt` in the main directory of the external memory.
- Open the `startup.txt` file in the text editor and add the following line:
`autoUpdate=<software_image_file_name>.bin`
- Install the external memory in the device.
- Restart the device.
During the booting process, the device checks automatically the following criteria:
 - Is an external memory connected?
 - Is a `startup.txt` file in the main directory of the external memory?

- Does the device software image exist which is specified in the startup.txt file?
- Is the version of the device software image more recent than the device software that the device is currently using?

When the criteria are fulfilled, the device starts the update procedure.

The device copies the currently running device software into the backup memory.

As soon as the update procedure is completed successfully, the device reboots automatically and loads the new device software version.

- Check the result of the update procedure. The log file in the *Diagnostics > Report > System Log* dialog contains one of the following messages:
 - [S_watson_AUTOMATIC_SWUPDATE_SUCCESS](#)
Software update completed successfully
 - [S_watson_AUTOMATIC_SWUPDATE_ABORTED](#)
Software update aborted
 - [S_watson_AUTOMATIC_SWUPDATE_ABORTED_WRONG_FILE](#)
Software update aborted due to a wrong device software image
 - [S_watson_AUTOMATIC_SWUPDATE_ABORTED_SAVING_FILE](#)
Software update aborted because the device did not save the device software image.

7 Configuring the ports

The following port configuration functions are available.

- ▶ Enabling/Disabling the port
- ▶ Selecting the operating mode
- ▶ Gigabit Ethernet mode for ports

7.1 Enabling/Disabling the port

In the default setting, every port is enabled. For a higher level of access security, disable unconnected ports. To do this, perform the following steps:

- Open the *Basic Settings > Port* dialog, *Configuration* tab.
- To enable a port, mark the checkbox in the *Port on* column.
- To disable a port, unmark the checkbox in the *Port on* column.
- Apply the settings temporarily. To do this, click the  button.

enable

To change to the Privileged EXEC mode.

configure

To change to the Configuration mode.

interface 1/1

To change to the interface configuration mode of interface 1/1.

no shutdown

To enable the interface.

7.2 Selecting the operating mode

In the default setting, the ports are set to *Autoneg* operating mode.

Note: The active automatic configuration has priority over the manual configuration.

Perform the following steps:

- Open the *Basic Settings > Port* dialog, *Configuration* tab.
- If the device connected to this port requires a fixed setting, then perform the following steps:
 - Deactivate the function. Unmark the checkbox in the *Autoneg* column.
 - In the *Manual configuration* column, specify the desired operating mode (transmission rate, duplex mode).
- Apply the settings temporarily. To do this, click the button.

enable

To change to the Privileged EXEC mode.

configure

To change to the Configuration mode.

interface 1/1

To change to the interface configuration mode of interface *1/1*.

no auto-negotiate

To disable the automatic configuration mode.

speed 100 full

To set port speed 100 Mbit/s and full-duplex.

7.3 Gigabit Ethernet mode for ports

The device supports 2.5 Gbit/s on several interfaces with one of the following SFP transceivers:

- ▶ M-SFP-2.5-MM/LC EEC
- ▶ M-SFP-2.5-SM-/LC EEC
- ▶ M-SFP-2.5-SM/LC EEC
- ▶ M-SFP-2.5-SM+/LC EEC

The device supports 10 Gbit/s on several interfaces with one of the following SFP+ transceivers:

- ▶ M-SFP-10-SR/LC EEC
- ▶ M-SFP-10-LR/LC EEC
- ▶ M-SFP-10-ER/LC EEC
- ▶ M-SFP-10-ZR/LC

The type of the transceiver plugged into the slot determines the port speed. The device has no option to set the speed manually. Ports with 2.5 Gbit/s or 10 Gbit/s speed only support data rates of 1 Gbit/s and higher.

Note: For further information about the transceiver order numbers, see the “Accessories” chapter in the “Installation” user manual.

7.3.1 Checking port parameters

You use the Gigabit Ethernet mode to get a higher bandwidth for uplinks. To use this function, insert an applicable transceiver type in the appropriate slot.

Perform the following steps:

- Open the *Basic Settings > Port* dialog, *Configuration* tab.

The column *Manual configuration* displays the value *2.5 Gbit/s FDX* for the ports that have a 2.5 Gbit/s SFP transceiver inserted.

The column *Manual configuration* displays the value *10 Gbit/s FDX* for the ports that have a 10 Gbit/s SFP+ transceiver inserted.

You cannot change the speed.

show port 1/1

To display the parameters for slot 1 port 1. The *Physical Mode* list entry displays the value *2500 full* for the ports that have a 2.5 Gbit/s SFP transceiver inserted.

```
Interface.....1/1  
Name.....My interface  
--  
Cable-crossing Setting.....-  
Physical Mode.....2500 full  
Physical Status.....-
```

```
show port 1/2
```

To display the parameters for slot **1** port **2**. The **Physical Mode** list entry displays the value **10G full** for the ports that have a 10 Gbit/s SFP+ transceiver inserted.

```
Interface.....1/2  
Name.....My interface  
--  
Cable-crossing Setting.....-  
Physical Mode.....10G full  
Physical Status.....-
```

8 Assistance in the protection from unauthorized access

The device offers functions that help you protect the device against unauthorized access.

After you set up the device, carry out the following steps to reduce possible unauthorized access to the device.

- ▶ Changing the SNMPv1/v2 community
- ▶ Disabling SNMPv1/v2
- ▶ Disabling HTTP
- ▶ Using your own HTTPS certificate
- ▶ Using your own SSH key
- ▶ Disabling Telnet
- ▶ Disabling HiDiscovery
- ▶ Restricting access to device management
- ▶ Adjusting the session timeouts
- ▶ Making SSH hosts known to the device

8.1 Changing the SNMPv1/v2 community

SNMPv1 and SNMPv2 work unencrypted. Every SNMP packet contains the IP address of the sender and the plaintext *community name* with which the sender accesses the device. If the [SNMPv1](#) and/or [SNMPv2](#) function is active, then the device lets anyone who knows the *community name* access the device. Treat the *community names* with discretion.

The *community names* [public](#) for *read-only* access and [private](#) for *read and write* access are preset. If you are using SNMPv1 or SNMPv2, then change the default *community name*. To do this, perform the following steps:

- Open the [Device Security > Management Access > SNMPv1/v2 Community](#) dialog. The dialog displays the communities that are set up.
- For the [Write](#) community, specify in the [Name](#) column the *community name*.
 - Up to 64 alphanumeric characters are allowed.
 - The device differentiates between upper and lower case.
 - Specify a different *community name* than for *read-only* access.
- Apply the settings temporarily. To do this, click the button.

enable

To change to the Privileged EXEC mode.

configure

To change to the Configuration mode.

```
snmp community rw <community name>
```

To specify the community for *read and write* access.

```
show snmp community
```

To display the communities that have been set up.

```
save
```

To save the settings in the non-volatile memory (*nvm*) in the “Selected” configuration profile.

8.2 Disabling SNMPv1/v2

If you need SNMPv1 or SNMPv2, then use these protocols only in environments protected from eavesdropping. SNMPv1 and SNMPv2 do not use encryption. The SNMP packets contain the community in clear text. We recommend using SNMPv3 in the device and disabling the access using SNMPv1 and SNMPv2. To do this, perform the following steps:

- Open the *Device Security > Management Access > Server* dialog, *SNMP* tab. The dialog displays the settings of the SNMP server.
- To deactivate the SNMPv1 protocol, you unmark the *SNMPv1* checkbox.
- To deactivate the SNMPv2 protocol, you unmark the *SNMPv2* checkbox.
- Apply the settings temporarily. To do this, click the  button.

```
enable
configure
no snmp access version v1
no snmp access version v2
show snmp access
save
```

To change to the Privileged EXEC mode.

To change to the Configuration mode.

To deactivate the SNMPv1 protocol.

To deactivate the SNMPv2 protocol.

To display the SNMP server settings.

To save the settings in the non-volatile memory (*nvm*) in the “Selected” configuration profile.

8.3 Disabling HTTP

The web server provides the Graphical User Interface with the protocol HTTP or HTTPS. HTTPS connections are encrypted, while HTTP connections are unencrypted.

The HTTP protocol is enabled by default. If you disable HTTP, then no unencrypted access to the Graphical User Interface is possible. To do this, perform the following steps:

- Open the *Device Security > Management Access > Server* dialog, *HTTP* tab.
- To disable the HTTP protocol, select the *Off* radio button in the *Operation* frame.
- Apply the settings temporarily. To do this, click the button.

enable	To change to the Privileged EXEC mode.
configure	To change to the Configuration mode.
no http server	To disable the HTTP protocol.

If the HTTP protocol is disabled, then you can reach the Graphical User Interface of the device only by HTTPS. In the address bar of the web browser, enter the string `https://` before the IP address of the device.

If the HTTPS protocol is disabled and you also disable HTTP, then the Graphical User Interface is inaccessible. To work with the Graphical User Interface, enable the HTTPS server using the Command Line Interface. To do this, perform the following steps:

enable	To change to the Privileged EXEC mode.
configure	To change to the Configuration mode.
https server	To enable the HTTPS protocol.

8.4 Disabling Telnet

The device lets you remotely access the device management using Telnet or SSH. Telnet connections are unencrypted, while SSH connections are encrypted.

The Telnet server is enabled in the device by default. If you disable Telnet, then unencrypted remote access to the Command Line Interface is no longer possible. To do this, perform the following steps:

- Open the *Device Security > Management Access > Server* dialog, *Telnet* tab.
- To disable the Telnet server, select the *Off* radio button in the *Operation* frame.
- Apply the settings temporarily. To do this, click the  button.

enable	To change to the Privileged EXEC mode.
configure	To change to the Configuration mode.
no telnet server	To disable the Telnet server.

If the SSH server is disabled and you also disable Telnet, then access to the Command Line Interface is only possible through the serial interface of the device. To work remotely with the Command Line Interface, enable SSH. To do this, perform the following steps:

- Open the *Device Security > Management Access > Server* dialog, *SSH* tab.
- To enable the *SSH* server, select the *On* radio button in the *Operation* frame.
- Apply the settings temporarily. To do this, click the  button.

enable	To change to the Privileged EXEC mode.
configure	To change to the Configuration mode.
ssh server	To enable the SSH server.

8.5 Disabling the HiDiscovery access

HiDiscovery lets you assign IP parameters to the device over the network during commissioning. HiDiscovery communicates in the device management VLAN without encryption and authentication.

After the device is commissioned, we recommend to set HiDiscovery to read-only or to disable HiDiscovery access completely. To do this, perform the following steps:

- Open the *Basic Settings > Network > Global* dialog.
- To take away write permission from the HiDiscovery software, in the *HiDiscovery protocol v1/v2* frame, specify the value *readOnly* in the *Access* field.
- To disable HiDiscovery access completely, select the *Off* radio button in the *HiDiscovery protocol v1/v2* frame.
- Apply the settings temporarily. To do this, click the  button.

enable

network hidiscovery mode read-only

no network hidiscovery operation

To change to the Privileged EXEC mode.

To disable write permission of the HiDiscovery software.

To disable HiDiscovery access.

8.6 Restricting access to device management

In the default setting, everyone can access the device management from any IP address using any protocol. The device lets you restrict access to device management for selected protocols from a specific IP address range.



8.6.1 Restricting access from a specific IP address range

In the following example, the device is to be accessible only from the company network using the Graphical User Interface. The administrator has additional remote access using SSH. The company network has the address range [192.168.1.0/24](#) and remote access from a mobile network with the IP address range [109.237.176.0/24](#). The SSH application program knows the fingerprint of the RSA key.

Table 19: Parameters for the IP access restriction

Parameter	Company network	Mobile phone network
Network address	192.168.1.0	109.237.176.0
Netmask	24	24
Desired protocols	https, snmp	ssh

Perform the following steps:

- Open the [Device Security > Management Access > IP Access Restriction](#) dialog.
 - Unmark the checkbox in the [Active](#) column for the table row.
This entry lets users have access to the device from any IP address and the supported protocols.
- Address range of the company network:
- To add a table row, click the  button.
 - Specify the address range of the company network in the [IP address range](#) column: [192.168.1.0/24](#)
 - For the address range of the corporate network, deactivate the undesired protocols. The [HTTPS](#), [SNMP](#), and [Active](#) checkboxes remain marked.
- Address range of the mobile phone network:
- To add a table row, click the  button.
 - Specify the address range of the mobile network in the [IP address range](#) column: [109.237.176.0/24](#)
 - For the address range of the mobile network, deactivate the undesired protocols. The [SSH](#) and [Active](#) checkboxes remain marked.
- Note:** Before you enable the access restriction, verify that the table contains at least one active rule that grants you access to the device management. Otherwise, access to device management is only possible using the Command Line Interface through the serial connection.
- To enable the access restriction, select the [On](#) radio button in the [Operation](#) frame.
 - Apply the settings temporarily. To do this, click the  button.

<code>enable</code>	To change to the Privileged EXEC mode.
<code>show network management access global</code>	To display if the access restriction is enabled or disabled.
<code>show network management access rules</code>	To display the entries that have been configured.
<code>no network management access operation</code>	To disable the IP access restriction.
<code>network management access add 2</code>	To add a rule with index 2 for the address range of the company network.
<code>network management access modify 2 ip 192.168.1.0</code>	To specify the IP address of the company network.
<code>network management access modify 2 mask 24</code>	To specify the netmask of the company network.
<code>network management access modify 2 ssh disable</code>	To deactivate SSH for the address range of the company network. Repeat the operation for every unwanted protocol.
<code>network management access add 3</code>	To add a rule with index 3 for the address range of the mobile phone network.
<code>network management access modify 3 ip 109.237.176.0</code>	To specify the IP address of the mobile phone network.
<code>network management access modify 3 mask 24</code>	To specify the netmask of the mobile phone network.
<code>network management access modify 3 snmp disable</code>	To deactivate SNMP for the address range of the mobile phone network. Repeat the operation for every unwanted protocol.
<code>no network management access status 1</code>	To deactivate the default entry. This entry lets users have access to the device from any IP address and the supported protocols.
<code>network management access status 2</code>	To activate the rule with index 2 for the address range of the company network.
<code>network management access status 3</code>	To activate the rule with index 3 for the address range of the mobile phone network.
<code>show network management access rules</code>	To display the entries that have been configured.
<code>network management access operation</code>	To enable the access restriction.

8.7 Adjusting the session timeouts

The device lets you automatically terminate the session upon inactivity of the user that is logged in. The session timeout is the period of inactivity after the last user action.

You can specify a session timeout for the following applications:

- ▶ Command Line Interface sessions using an SSH connection
- ▶ Command Line Interface sessions using a Telnet connection
- ▶ Command Line Interface sessions using a serial connection
- ▶ Graphical User Interface

Timeout for Command Line Interface sessions using a SSH connection

Perform the following steps:

- Open the *Device Security > Management Access > Server* dialog, *SSH* tab.
- Specify the timeout period in minutes in the *Configuration* frame, *Session timeout [min]* field.
- Apply the settings temporarily. To do this, click the button.

enable

To change to the Privileged EXEC mode.

configure

To change to the Configuration mode.

```
ssh timeout <0..160>
```

To specify the timeout period in minutes for Command Line Interface sessions using an SSH connection.

Timeout for Command Line Interface sessions using a Telnet connection

Perform the following steps:

- Open the *Device Security > Management Access > Server* dialog, *Telnet* tab.
- Specify the timeout period in minutes in the *Configuration* frame, *Session timeout [min]* field.
- Apply the settings temporarily. To do this, click the button.

enable

To change to the Privileged EXEC mode.

configure

To change to the Configuration mode.

```
telnet timeout <0..160>
```

To specify the timeout period in minutes for Command Line Interface sessions using a Telnet connection.

Timeout for Command Line Interface sessions using a serial connection

Perform the following steps:

- Open the *Device Security > Management Access > CLI* dialog, *Global* tab.
- Specify the timeout period in minutes in the *Configuration* frame, *Serial interface timeout [min]* field.
- Apply the settings temporarily. To do this, click the button.

```
enable  
cli serial-timeout <0..160>
```

To change to the Privileged EXEC mode.

To specify the timeout period in minutes for Command Line Interface sessions using a serial connection.

Session timeout for the Graphical User Interface

Perform the following steps:

- Open the *Device Security > Management Access > Web* dialog.
- Specify the timeout period in minutes in the *Configuration* frame, *Web interface session timeout [min]* field.
- Apply the settings temporarily. To do this, click the button.

```
enable  
network management access web timeout  
<0..160>
```

To change to the Privileged EXEC mode.

To specify the timeout period in minutes for Graphical User Interface sessions

8.8 Making SSH hosts known to the device

The device permits SSH-based connections only to remote servers that are known to the device. In the state on delivery, no remote server is set up as a known host on the device.

When downloading a device software image or importing a configuration profile from an SCP or SFTP server, these protocols use an underlying SSH connection. For SSH, you make remote servers known by using their public key fingerprint. The device verifies the identity of the remote server by comparing the public key fingerprint stored on the device with the fingerprint calculated from the public key which the remote server actually sent. If the calculated public key fingerprint does not match the stored public key fingerprint, the device terminates the connection.

You can find out the public key fingerprint of the remote server and the key type, as follows:

- from the administrator of a known SSH server
- from the error message following an unsuccessful software update in the [Software](#) dialog due to the mismatch between the public key fingerprint stored in the device and the fingerprint calculated from the public key which the remote server actually sent. This option is not recommended if you transmit data over untrusted networks.

The device provides the following setting options:

- ▶ [Adding an SSH Known Hosts entry](#)
- ▶ [Updating an SSH Known Hosts entry](#)
- ▶ [Deactivating an SSH Known Hosts entry](#)
- ▶ [Deleting an SSH Known Hosts entry](#)

Adding an SSH Known Hosts entry

You can set up a maximum of 50 entries containing the server address and the public key fingerprint. If a remote server has several keys set up, for different encryption algorithms, add each of the public key fingerprints as a separate entry.

Verify that the public key fingerprints you store on the device are from a trustworthy source, the SSH server administrator, for example.

Perform the following steps:

- Open the [Basic Settings > Port](#) dialog.
- Click the  button.
The dialog displays the [Create](#) window.
- In the [Index](#) field, specify the index value. Assign a unique value.
- In the [Address](#) field, specify the IPv4 or IPv6 address, or the DNS hostname of the remote server.
- In the [Key fingerprint](#) field, enter the public key fingerprint of the remote server.
- From the [Key type](#) drop-down list, select the corresponding key type. This is the algorithm that the administrator of the remote server used to generate the server key pair.
- Click the [Ok](#) button.
The device adds a table row.
The device accepts establishing a connection to the remote server from now on.

enable	To change to the Privileged EXEC mode.
configure	To change to the Configuration mode.
ssh known-hosts add {index} address {ipv4 ipv6 dns} key-type {rsa dsa ecdsa ed25519} key-fingerprint {string_base64}	To add an entry with index, address of the remote server, key type, and public key fingerprint of the remote server.
show ssh known-hosts	To display the set up entries.
exit	To change to the Privileged EXEC mode.

To save the settings permanently, see section [“Saving a configuration profile” on page 97](#).

Updating an SSH Known Hosts entry

If the public key of the remote server changes, then you need to update the fingerprint in the respective table row.

Perform the following steps:

- Open the [Basic Settings > Port](#) dialog.
- Unmark the checkbox in the [Active](#) column.
- Apply the settings temporarily. To do this, click the button.
- In the [Key fingerprint](#) column, enter the new public key fingerprint of the remote server.
- Apply the settings temporarily. To do this, click the button.
- To activate the entry, mark the checkbox in the [Active](#) column.
- Apply the settings temporarily. To do this, click the button.

enable	To change to the Privileged EXEC mode.
configure	To change to the Configuration mode.
ssh known-hosts modify {index} status disable	To deactivate the entry.
ssh known-hosts modify {index} key-fingerprint {string_base64}	To modify the entry with the index number you have entered.
ssh known-hosts modify {index} status enable	To activate the entry.
show ssh known-hosts {index}	To check the updated entry.
exit	To change to the Privileged EXEC mode.

To save the settings permanently, see section [“Saving a configuration profile” on page 97](#).

Deactivating an SSH Known Hosts entry

You deactivate an entry, for example, when the current server key will soon become invalid due to the rotation of the server key.

Perform the following steps:

- Open the [Basic Settings > Port](#) dialog.
- In the table row for the relevant entry, unmark the checkbox in the [Active](#) column.
- Apply the settings temporarily. To do this, click the  button.

enable	To change to the Privileged EXEC mode.
configure	To change to the Configuration mode.
ssh known-hosts modify {index} status disable	To deactivate the entry with the index number you have entered.
show ssh known-hosts {index}	To check if the entry is inactive.
exit	To change to the Privileged EXEC mode.

To save the settings permanently, see section [“Saving a configuration profile” on page 97](#).

Deleting an SSH Known Hosts entry

If the device is no longer permitted to contact a remote server or the public key is no longer valid, then you can delete the corresponding entry.

Perform the following steps:

- Open the [Basic Settings > Port](#) dialog.
- In the table row for the relevant entry, mark the checkbox in the [Index](#) column.
Click the  button.

enable	To change to the Privileged EXEC mode.
configure	To change to the Configuration mode.
ssh known-hosts delete {index}	To delete the entry with the index number you have entered.
show ssh known-hosts {index}	To check if the entry has been deleted.
SSH known hosts information ----- No entry.	
exit	To change to the Privileged EXEC mode.

To save the settings permanently, see section [“Saving a configuration profile” on page 97](#).

9 Controlling the data traffic

The device checks the data packets to be forwarded in accordance with defined rules. Data packets to which the rules apply are either forwarded by the device or blocked. If data packets do not correspond to any of the rules, then the device blocks the packets.

Routing ports to which no rules are assigned allow packets to pass. As soon as a rule is assigned, the assigned rules are processed first. After that, the specified standard action of the device takes effect.

The device provides the following functions for controlling the data stream:

- ▶ Service request control (Denial of Service (DoS))
- ▶ Denying access to devices based on their IP or MAC address (ACL)

The device observes and monitors the data stream. The device takes the results of the observation and the monitoring and combines them with the rules for the network security to generate what is known as a status table. Based on this status table, the device decides whether to accept, drop or reject data.

The data packets go through the filter functions of the device in the following sequence:

- ▶ DoS ... if **permit** or **accept**, then progress to the next rule
- ▶ ACL ... if **permit** or **accept**, then progress to the next rule

9.1 Helping protect against DoS attacks

Denial of Service (DoS) is a cyberattack that aims to make certain services or devices unusable. Attackers as well as network administrators can use the port scan method to discover open ports in a network to find vulnerable devices. The function helps you protect the network against invalid or falsified data packets targeted at certain services or devices. You have the option of specifying filters to restrict the data stream for protection against DoS attacks. The filters check the received data packets. The device discards a data packet if it matches the filter criteria.

To help protect the device itself and other devices in the network from DoS attacks, the device lets you specify the following options:

- ▶ [Filters for TCP and UDP packets](#)
- ▶ [Filters for IP packets](#)
- ▶ [Filters for ICMP packets](#)

The filters help prevent an attacking station from:

- Detecting services and applications that use the open ports
- Detecting active devices in a network
- Accessing sensitive data in a network
- Detecting active security devices like a firewall used in a network

Note: You can combine the filters in any way. When you activate several filters, the device applies the filters in the order in which they are specified in the IP table. If an incoming data packet matches a filter, the device discards the respective data packet and then stops further processing.

9.1.1 Filters for TCP and UDP packets

To selectively process *TCP* and *UDP* packets, the device offers you the following filters:

- [Activating the Null Scan filter function](#)
- [Activating the Xmas filter function](#)
- [Activating the SYN/FIN filter function](#)
- [Activating the TCP Offset protection function](#)
- [Activating the TCP SYN protection function](#)
- [Activating the L4 Port protection function](#)
- [Activating the Min. Header Size filter function](#)

Activating the Null Scan filter function

With the *Null Scan* method, the attacking station sends data packets with the following properties:

- No *TCP* flags are set.
- The *TCP* sequence number is 0.

The device uses the *Null Scan filter* function to discard incoming *TCP* packets that contain malicious properties.

In the default setting, the *Null Scan filter* function is disabled. To activate the *Null Scan filter* function, perform the following steps:

- Open the *Network Security > DoS > Global* dialog.
- Activate the *Null Scan filter* function. To do this, in the *TCP/UDP* frame, mark the *Null Scan filter* checkbox.
- Apply the settings temporarily. To do this, click the button.

enable

To change to the Privileged EXEC mode.

configure

To change to the Configuration mode.

dos tcp-null

To activate the *Null Scan filter* function.

no dos tcp-null

To deactivate the *Null Scan filter* function.

Activating the Xmas filter function

With the *Xmas* method, the attacking station sends data packets with the following properties:

- The *TCP* flags *FIN*, *URG*, and *PSH* are simultaneously set.
- The *TCP* sequence number is 0.

The device uses the *Xmas filter* function to discard incoming *TCP* packets that contain malicious properties.

In the default setting, the *Xmas filter* function is disabled. To activate the *Xmas filter* function, perform the following steps:

- Open the *Network Security > DoS > Global* dialog.
- Activate the *Xmas filter* function. To do this, in the *TCP/UDP* frame, mark the *Xmas filter* checkbox.
- Apply the settings temporarily. To do this, click the button.

enable	To change to the Privileged EXEC mode.
configure	To change to the Configuration mode.
dos tcp-xmas	To activate the <i>Xmas filter</i> function.
no dos tcp-xmas	To deactivate the <i>Xmas filter</i> function.

Activating the SYN/FIN filter function

With the *SYN/FIN* method, the attacking station sends data packets with the *TCP* flags *SYN* and *FIN* set simultaneously. The device uses the *SYN/FIN filter* function to discard incoming packets with the *TCP* flags *SYN* and *FIN* set simultaneously.

In the default setting, the *SYN/FIN filter* function is disabled. To activate the *SYN/FIN filter* function, perform the following steps:

- Open the *Network Security > DoS > Global* dialog.
- Activate the *SYN/FIN filter* function. To do this, in the *TCP/UDP* frame, mark the *SYN/FIN filter* checkbox.
- Apply the settings temporarily. To do this, click the button.

enable	To change to the Privileged EXEC mode.
configure	To change to the Configuration mode.
dos tcp-syn-fin	To activate the <i>SYN/FIN filter</i> function.
no dos tcp-syn-fin	To deactivate the <i>SYN/FIN filter</i> function.

Activating the TCP Offset protection function

With the *TCP Offset* method, the attacking station sends data packets whose fragment offset is equal to **1**. The fragment offset is a field in the *IP* header which helps to identify the sequence of fragments in received data packets. The device uses the *TCP Offset protection* function to discard incoming *TCP* data packets whose fragment offset field in the *IP* header is equal to **1**.

Note: The device accepts *UDP* and *ICMP* packets whose fragment offset field of the *IP* header is equal to **1**.

In the default setting, the *TCP Offset protection* function is disabled. To activate the *TCP Offset protection* function, perform the following steps:

- Open the *Network Security > DoS > Global* dialog.
- Activate the *TCP Offset protection* function. To do this, in the *TCP/UDP* frame, mark the *TCP Offset protection* checkbox.
- Apply the settings temporarily. To do this, click the button.

enable	To change to the Privileged EXEC mode.
configure	To change to the Configuration mode.
dos tcp-offset	To activate the <i>TCP Offset protection</i> function.
no dos tcp-offset	To deactivate the <i>TCP Offset protection</i> function.

Activating the TCP SYN protection function

With the *TCP SYN* method, the attacking station sends data packets with the *TCP* flag *SYN* set and an L4 (layer 4) source port <1024. The device uses the *TCP SYN protection* function to discard incoming packets with the *TCP* flag *SYN* set and an L4 (layer 4) source port <1024.

In the default setting, the *TCP SYN protection* function is disabled. To activate the *TCP SYN protection* function, perform the following steps:

- Open the *Network Security > DoS > Global* dialog.
- Activate the *TCP SYN protection* function. To do this, in the *TCP/UDP* frame, mark the *TCP SYN protection* checkbox.
- Apply the settings temporarily. To do this, click the button.

enable	To change to the Privileged EXEC mode.
configure	To change to the Configuration mode.
dos tcp-syn	To activate the <i>TCP SYN protection</i> function.
no dos tcp-syn	To deactivate the <i>TCP SYN protection</i> function.

Activating the L4 Port protection function

An attacking station can send *TCP* or *UDP* data packets whose source port number and destination port number are identical. The device uses the *L4 Port protection* function to discard incoming *TCP* and *UDP* packets whose L4 source port and destination port number are identical.

In the default setting, the *L4 Port protection* function is disabled. To activate the *L4 Port protection* function, perform the following steps:

- Open the *Network Security > DoS > Global* dialog.
- Activate the *L4 Port protection* function. To do this, in the *TCP/UDP* frame, mark the *L4 Port protection* checkbox.
- Apply the settings temporarily. To do this, click the button.

enable

To change to the Privileged EXEC mode.

configure

To change to the Configuration mode.

dos 14-port

To activate the *L4 Port protection* function.

no dos 14-port

To deactivate the *L4 Port protection* function.

Activating the Min. Header Size filter function

The *Min. Header Size filter* function detects received data packets with the following properties:

$(IP \text{ payload length in the } IP \text{ header} - IP \text{ header outer size}) < \text{minimum } TCP \text{ header size}$.

If the received packet is the first fragment that the device detects, then the device discards the data packet.

In the default setting, the *Min. Header Size filter* function is disabled. To activate the *Min. Header Size filter* function, perform the following steps:

- Open the *Network Security > DoS > Global* dialog.
- Activate the *Min. Header Size filter* function. To do this, in the *TCP/UDP* frame, mark the *Min. Header Size filter* checkbox.
- Apply the settings temporarily. To do this, click the button.

enable

To change to the Privileged EXEC mode.

configure

To change to the Configuration mode.

dos tcp-min-header

To activate the *Min. Header Size filter* function.

no dos tcp-min-header

To deactivate the *Min. Header Size filter* function.

9.1.2 Filters for IP packets

To selectively process *IP* packets, the device offers you the following filters:

- [Activating the Land Attack filter function](#)

Activating the Land Attack filter function

With the *Land Attack* method, the attacking station sends data packets whose source and destination addresses are identical to the *IP* address of the recipient. The device uses the [Land Attack filter](#) function to discard received packets whose source and destination addresses are identical.

In the default setting, the [Land Attack filter](#) function is disabled. To activate the [Land Attack filter](#) function, perform the following steps:

- Open the [Network Security > DoS > Global](#) dialog.
- Activate the [Land Attack filter](#) function. To do this, in the *IP* frame, mark the [Land Attack filter](#) checkbox.
- Apply the settings temporarily. To do this, click the  button.

enable	To change to the Privileged EXEC mode.
configure	To change to the Configuration mode.
dos ip-land enable	To activate the Land Attack filter function.
no dos ip-land disable	To deactivate the Land Attack filter function.

9.1.3 Filters for ICMP packets

To selectively process *ICMP* packets, the device offers you the following filters:

- [Activating the Fragmented packets filter function](#)
- [Activating the Packet size filter function](#)
- [Activating the Drop broadcast ping function](#)

Activating the Fragmented packets filter function

The device uses the *Fragmented packets filter* function to protect the network from attacking stations that send fragmented *ICMP* packets. Fragmented *ICMP* packets can cause the destination device to fail if the destination device processes fragmented *ICMP* packets incorrectly. The device uses the *Fragmented packets filter* function to discard fragmented *ICMP* packets.

In the default setting, the *Fragmented packets filter* function is disabled. To activate the *Fragmented packets filter* function, perform the following steps:

- Open the *Network Security > DoS > Global* dialog.
- Activate the *Fragmented packets filter* function. To do this, in the *ICMP* frame, mark the *Fragmented packets filter* checkbox.
- Apply the settings temporarily. To do this, click the button.

enable	To change to the Privileged EXEC mode.
configure	To change to the Configuration mode.
dos icmp-fragmented	To activate the <i>Fragmented packets filter</i> function.
no dos icmp-fragmented	To deactivate the <i>Fragmented packets filter</i> function.

Activating the Packet size filter function

The device uses the *Packet size filter* to discard data packets whose payload size exceeds the size specified in the *Allowed payload size [byte]* field.

The *Packet size filter* function helps protect the network from attacking stations that send *ICMP* packets whose payload size exceeds the size specified in the *Allowed payload size [byte]* field.

In the default setting, the *Packet size filter* function is disabled. To activate the *Packet size filter* function, perform the following steps:

- Open the *Network Security > DoS > Global* dialog.
- Activate the *Packet size filter* function. To do this, in the *ICMP* frame, mark the *Packet size filter* checkbox.
- Apply the settings temporarily. To do this, click the button.

enable	To change to the Privileged EXEC mode.
configure	To change to the Configuration mode.
dos icmp payload-check	To activate the <i>Packet size filter</i> function.
no dos icmp payload-check	To deactivate the <i>Packet size filter</i> function.

Activating the Drop broadcast ping function

The *Drop broadcast ping* function helps protect the network from broadcast ping attacks, also known as ICMP Smurf attacks. With the Broadcast ping method, the attacker floods a target device (the victim) by sending a large number of *ICMP echo request* packets to the IPv4 broadcast address. These packets contain a spoofed IP source address which is the IP address of the victim. Stations responding to the Broadcast ping send their replies to the victim, thus flooding the victim and possibly causing instability.

The device uses the *Drop broadcast ping* function to discard the Broadcast pings.

In the default setting, the *Drop broadcast ping* function is disabled. To activate the *Drop broadcast ping* function, perform the following steps:

- Open the *Network Security > DoS > Global* dialog.
- Activate the *Drop broadcast ping* function. To do this, in the *ICMP* frame, mark the *Drop broadcast ping* checkbox.
- Apply the settings temporarily. To do this, click the  button.

enable

configure

dos icmp-smurf-attack

no dos icmp-smurf-attack

To change to the Privileged EXEC mode.

To change to the Configuration mode.

To activate the *Drop broadcast ping* function.

To deactivate the *Drop broadcast ping* function.

9.2 ACL

In this menu you can enter the parameters for the Access Control Lists (ACLs).

The device uses ACLs to filter data packets received on VLANs or on individual or multiple ports. In a ACL, you specify rules that the device uses to filter data packets. When such a rule applies to a packet, the device applies the actions specified in the rule to the packet. The available actions are as follows:

- ▶ allow ([permit](#))
- ▶ discard ([deny](#))
- ▶ redirect to a certain port (see [Redirection port](#) field)
- ▶ mirror (see [Mirror port](#) field)

The list below contains criteria that you can apply to filter the data packets:

- ▶ Source or destination address of a packet (MAC)
- ▶ Source or destination address of a data packet (IPv4)
- ▶ Source or destination port of a data packet (IPv4)

You can specify the following ACL types:

- ▶ IP ACLs for VLANs
- ▶ IP ACLs for ports
- ▶ MAC ACLs for VLANs
- ▶ MAC ACLs for ports

When you assign both an IP ACL and MAC ACL to the same interface, the device first uses the IP ACL to filter the data stream. The device applies the MAC ACL rules only after the packets are filtered through the IP ACL. The priority of an ACL is independent of the index of a rule.

Within an ACL, the device processes the rules in order. The index of the respective rule determines the order in which the device filters the data stream. When you assign an ACL to a port or VLAN, you can specify its priority with the index. The lower the number, the higher the priority. The device processes the rule with the higher priority first.

If none of the rules specified in an ACL applies to a data packet, then the implicit [deny](#) rule applies. As a result, the device drops the received data packets.

Keep in mind that the device directly implements the implicit [deny](#) rule.

Note: The number of available ACLs depends on the device. For further information about the ACL values, see chapter [“Technical Data” on page 376](#).

Note: You can assign a single ACL to any number of ports or VLANs.

The [ACL](#) menu contains the following dialogs:

- ▶ [IPv4 Rule](#)
- ▶ [MAC Rule](#)
- ▶ [Assignment](#)

These dialogs provide the following options:





- ▶ To specify the rules for the various ACL types.
- ▶ To provide the rules with the required priorities.
- ▶ To assign the ACLs to ports or VLANs.

9.2.1 Creating and editing IPv4 rules

When filtering IPv4 data packets, the device lets you:

- ▶ add new groups and rules
- ▶ add new rules to existing groups
- ▶ edit an existing rule
- ▶ activate and deactivate groups and rules
- ▶ delete existing groups and rules
- ▶ change the order of existing rules

Perform the following steps:

- Open the *Network Security > ACL > IPv4 Rule* dialog.
- Click the  button.
The dialog displays the *Create* window.
- Specify the name of the ACL (group).
 - To add the rule in an existing ACL, click the *Group name* field and select the name from the drop-down list.
 - To add the rule in a new ACL, specify a meaningful name in the *Group name* field and click the  icon.
- In the *Index* field you specify the number for the rule within the ACL.
This number defines the priority of the rule.
- Click the *Ok* button.
The device adds the rule to the ACL (group) in the table.
The rule is active immediately.
 - To remove a rule, select the desired table row and click the  button.
- Edit the rule parameters in the table. To change a value, double-click the relevant field.
- Apply the settings temporarily. To do this, click the  button.

Note: The device lets you use wildcards with the *Source IP address* and *Destination IP address* parameters. If you enter for example, *192.168.?.?*, then the device allows addresses that start with *192.168*.

Note: The prerequisite for changing the values in the *Source TCP/UDP port* and *Destination TCP/UDP port* column is that you specify the value *tcp* or *udp* in the *Protocol* column.

Note: The prerequisite for changing the value in the *Redirection port* and *Mirror port* column is that you specify the value *permit* in the *Action* column.

9.2.2 Creating and configuring an IP ACL using the Command Line Interface

In the following example, you set up ACLs to block the communication from computers B and C to computer A, based on the IP address (TCP/UDP port, etc.).

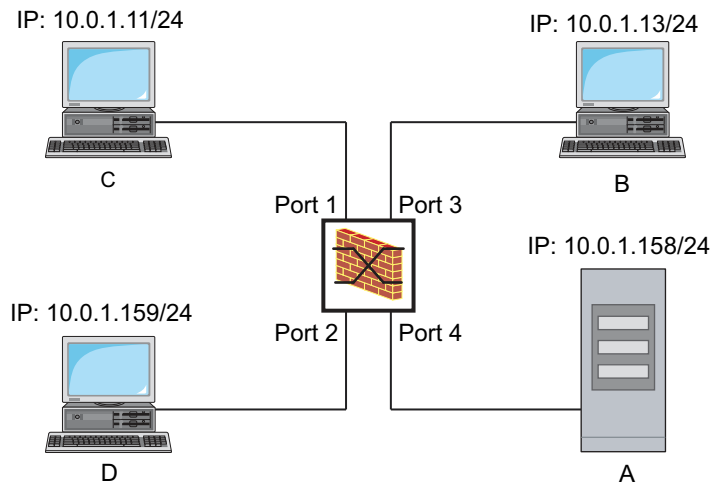

Figure 21: Application example of an IP ACL

Perform the following steps:

```
enable
configure
ip access-list extended name filter1 deny
src 10.0.1.11-0.0.0.0 dst 10.0.1.158-
0.0.0.0 assign-queue 1

ip access-list extended name filter1 permit
src any dst any

show access-list ip filter1

ip access-list extended name filter2 deny
src 10.0.1.13-0.0.0.0 dst 10.0.1.158-
0.0.0.0 assign-queue 1

show access-list ip filter2
```

To change to the Privileged EXEC mode.

To change to the Configuration mode.

To add an IP ACL with name `filter1`. To add a rule denying IP data packets from `10.0.1.11` to `10.0.1.158`. Priority 1 (highest priority).

To add a rule to the IP ACL admitting IP data packets.

To display the rules of the IP ACL `filter1`.

To add an IP ACL with name `filter2`. To add a rule denying IP data packets from `10.0.1.13` to `10.0.1.158`. Priority 1 (highest priority).





To display the rules of the IP ACL `filter2`.

9.2.3 Creating and editing MAC rules

When filtering MAC data packets, the device lets you:

- ▶ add new groups and rules
- ▶ add new rules to existing groups
- ▶ edit an existing rule
- ▶ activate and deactivate groups and rules
- ▶ delete existing groups and rules
- ▶ change the order of existing rules

Perform the following steps:

- Open the *Network Security > ACL > MAC Rule* dialog.
- Click the  button.
The dialog displays the *Create* window.
- Specify the name of the ACL (group).
 - To add the rule in an existing ACL, click the *Group name* field and select the name from the drop-down list.
 - To add the rule in a new ACL, specify a meaningful name in the *Group name* field and click the  icon.
- In the *Index* field you specify the number for the rule within the ACL.
This number defines the priority of the rule.
- Click the *Ok* button.
The device adds the rule to the ACL (group) in the table.
The rule is active immediately.
 - To remove a rule, select the desired table row and click the  button.
- Edit the rule parameters in the table. To change a value, double-click the relevant field.
- Apply the settings temporarily. To do this, click the  button.

Note: In the *Source MAC address* and *Destination MAC address* fields you can use wildcards in the `FF:?:?:?:?:?:?:?` or `?:?:?:?:?:?:00:01` form. Use capital letters here.

9.2.4 Creating and configuring a MAC ACL using the Command Line Interface

In the following example, AppleTalk and IPX are to be filtered out from the entire network. To do this, perform the following steps:

<pre>enable configure mac acl add 1 macfilter mac acl rule add 1 1 deny src any any dst any any etype appletalk mac acl rule add 1 2 deny src any any dst any any etype ipx-old mac acl rule add 1 3 deny src any any dst any any etype ipx-new mac acl rule add 1 4 permit src any any dst any any show acl mac rules 1 interface 1/1,1/2,1/3,1/4,1/5,1/6</pre>	<p>To change to the Privileged EXEC mode.</p> <p>To change to the Configuration mode.</p> <p>To add a MAC ACL with the ID 1 and the name <i>macfilter</i>.</p> <p>To add a rule to position 1 of the MAC ACL with the ID 1 rejecting packets with EtherType <code>0x809B</code> (AppleTalk).</p> <p>To add a rule to position 2 of the MAC ACL with the ID 1 rejecting packets with EtherType <code>0x8137</code> (IPX alt).</p> <p>To add a rule to position 3 of the MAC ACL with the ID 1 rejecting packets with EtherType <code>0x8138</code> (IPX).</p> <p>To add a rule to position 4 of the MAC ACL with the ID 1 forwarding packets.</p> <p>To display the rules of the MAC ACL with the ID 1.</p> <p>To change to the interface configuration mode of the interfaces 1/1 to 1/6.</p>
--	---

```
acl mac assign 1 in 1
```

```
exit
```

```
show acl mac assignment 1
```

To assign the MAC ACL with the ID **1** to incoming data packets (**1/1**) on interfaces **1/6** to **in**.

To leave the interface mode.



To display the assignment of the MAC ACL with the ID **1** to interfaces or VLANs.

9.2.5 Assigning ACLs to a port or VLAN

When you assign ACLs to a port or VLAN, the device gives you the following options:

- ▶ To select the port or VLAN.
- ▶ To specify the ACL priority.
- ▶ To select the ACL using the group name.

Perform the following steps:

- Open the [Network Security > ACL > Assignment](#) dialog.
- Click the  button.
The dialog displays the [Create](#) window.
 - In the [Port/VLAN](#) field, specify the desired port or the desired VLAN.
 - In the [Priority](#) field, specify the priority.
 - In the [Direction](#) field, specify the data packets to which the device applies the rule.
 - In the [Group name](#) field, specify the rule the device assigns to the port or the VLAN.
- Click the [Ok](#) button.
- Apply the settings temporarily. To do this, click the  button.

10 Network load control

The device features a number of functions that can help you reduce the network load:

- ▶ Direct packet distribution
- ▶ Multicasts
- ▶ Rate limiter
- ▶ Prioritization - QoS
- ▶ Flow control

10.1 Direct packet distribution

The device reduces the network load with direct packet distribution.

On each of its ports, the device learns the sender MAC address of received data packets. The device stores the combination “port and MAC address” in its MAC address table (forwarding database).

By applying the *Store and Forward* method, the device buffers data received and checks it for validity before forwarding it. The device rejects invalid and corrupt data packets.

10.1.1 Learning MAC addresses

When the device receives a data packet, it checks if the MAC address of the sender is already stored in the MAC address table (forwarding database). When the MAC address of the sender is unknown, the device generates an entry. The device then compares the destination MAC address of the data packet with the entries stored in the MAC address table (forwarding database):

- ▶ The device forwards packets with a known destination MAC address directly to ports that have already received data packets from this MAC address.
- ▶ The device floods data packets with unknown destination addresses, that is, the device forwards these data packets to every port.

10.1.2 Aging of learned MAC addresses

Addresses that have not been detected by the device for an adjustable period of time (aging time) are deleted from the MAC address table (forwarding database) by the device. A reboot or resetting the MAC address table (forwarding database) deletes the entries in the MAC address table (forwarding database).



10.1.3 Static address entries

In addition to learning the sender MAC address, the device also provides the option to set MAC addresses manually. These MAC addresses remain set up and survive resetting of the MAC address table (forwarding database) as well as rebooting of the device.

Static address entries allow the device to forward data packets directly to selected ports. If you do not specify a destination port, then the device discards the corresponding data packets.

You manage the static address entries in the Graphical User Interface or in the Command Line Interface.

Perform the following steps:



- Create a static address entry.
 - Open the *Switching > Filter for MAC Addresses* dialog.
 - Add a user-configurable MAC address:
 - ▶ Click the  button.
The dialog displays the *Create* window.
 - ▶ In the *MAC address* field, specify the destination MAC address.
 - ▶ In the *VLAN ID* field, specify the VLAN ID.
 - ▶ In the *Port* list, select the ports to which the device forwards data packets with the specified destination MAC address in the specified VLAN.
When you have defined a Unicast MAC address in the *MAC address* field, select only one port.
When you have defined a Multicast MAC address in the *MAC address* field, select one or more ports.
If you want the device to discard data packets with the destination MAC address, then do not select any port.
 - ▶ Click the *Ok* button.
 - Apply the settings temporarily. To do this, click the  button.

enable	To change to the Privileged EXEC mode.
configure	To change to the Configuration mode.
mac-filter <MAC address> <VLAN ID>	To add the MAC address filter, consisting of a MAC address and VLAN ID.
interface 1/1	To change to the interface configuration mode of interface 1/1 .
mac-filter <MAC address> <VLAN ID>	To assign the port to a previously added MAC address filter.
save	To save the settings in the non-volatile memory (<i>nvm</i>) in the “Selected” configuration profile.

- Convert a learned MAC address into a static address entry.

- Open the [Switching > Filter for MAC Addresses](#) dialog.
- To convert a learned MAC address into a static address entry, select the value [Permanent](#) in the [Status](#) column.
- Apply the settings temporarily. To do this, click the  button.

- Disable a static address entry.

- Open the [Switching > Filter for MAC Addresses](#) dialog.
- To disable a static address entry, remove it from the table. To do this, select the table row that contains the value [Permanent](#) in the [Status](#) column, then click the  button.
- Apply the settings temporarily. To do this, click the  button.

enable	To change to the Privileged EXEC mode.
configure	To change to the Configuration mode.
interface 1/1	To change to the interface configuration mode of interface 1/1 .
no mac-filter <MAC address> <VLAN ID>	To cancel the assignment of the MAC address filter on the port.
exit	To change to the Configuration mode.
no mac-filter <MAC address> <VLAN ID>	To delete the MAC address filter, consisting of a MAC address and a VLAN ID.
exit	To change to the Privileged EXEC mode.
save	To save the settings in the non-volatile memory (<i>nvm</i>) in the “Selected” configuration profile.

- Delete learned MAC addresses.

- To delete the learned addresses from the MAC address table (forwarding database), click the  button.
As an alternative, open the [Basic Settings > Restart](#) dialog and click the [Clear FDB](#) button.

 `clear mac-addr-table`

To delete the learned MAC addresses from the MAC address table (forwarding database).

10.2 Multicasts

By default, the device floods data packets with a Multicast address, that is, the device forwards the data packets to every port. This leads to an increased network load.

The use of IGMP snooping can reduce the network load caused by Multicast data packets. IGMP snooping lets the device send Multicast data packets only on those ports to which devices “interested” in Multicast are connected.

10.2.1 Example of a Multicast application

Surveillance cameras transmit images to monitors in the machine room and in the monitoring room. With an IP Multicast transmission, the cameras transmit their graphic data over the network in Multicast packets.

The Internet Group Management Protocol (IGMP) organizes the data streams between the Multicast routers and the monitors. The switches in the network between the Multicast routers and the monitors monitor the IGMP data packets continuously (IGMP Snooping).

Switches register logins for receiving a Multicast stream (IGMP report). The device then adds an entry in the MAC address table (forwarding database) and forwards Multicast packets only to the ports on which it has previously received IGMP reports.

10.2.2 IGMP snooping

The Internet Group Management Protocol (IGMP) describes the distribution of Multicast information between routers and connected receivers on Layer 3. IGMP Snooping describes the function of a switch of continuously monitoring IGMP data packets and optimizing its own transmission settings for these data packets.

The *IGMP Snooping* function in the device operates according to RFC 4541 (*Considerations for Internet Group Management Protocol (IGMP) and Multicast Listener Discovery (MLD) Snooping Switches*).

Multicast routers with an active *IGMP* function periodically request (query) registration of Multicast streams to determine the associated IP Multicast group members. IP Multicast group members reply with a Report message. This Report message contains the parameters required by the *IGMP* function. The Multicast router enters the IP Multicast group address from the Report message in its routing table. This causes it to forward data packets with this IP Multicast group in the destination address field according to its routing table.

When leaving a Multicast group (IGMP version 2 and higher), receivers log out with a “Leave” message and do not send any more Report messages. If it does not receive any more Report messages from this receiver within a certain time (aging time), then the Multicast router removes the routing table entry of a receiver.

When several IGMP Multicast routers are in the same network, the device with the smaller IP address takes over the query function. When there are no Multicast routers on the network, you have the option to enable the query function in an appropriately equipped switch.

A switch that connects one Multicast receiver with a Multicast router analyzes the IGMP information with the IGMP snooping method.

The IGMP snooping method also makes it possible for switches to use the *IGMP* function. A switch stores the MAC addresses derived from IP addresses of the Multicast receivers as recognized Multicast addresses in its MAC address table (forwarding database). In addition, the switch identifies the ports on which it has received reports for a specific Multicast address. In this way, the switch forwards Multicast packets only to ports to which Multicast receivers are connected. The other ports do not receive these packets.

A special feature of the device is the possibility of determining the processing of data packets with unknown Multicast addresses. Depending on the setting, the device discards these data packets or forwards them to every port. By default, the device transmits the data packets only to ports with connected devices, which in turn receive query packets. You also have the option of additionally sending known Multicast packets to query ports.

Setting IGMP snooping

Perform the following steps:

- Open the *Switching > IGMP Snooping > Global* dialog.
 - To enable the function, select the *On* radio button in the *Operation* frame.
- When the *IGMP Snooping* function is disabled, the device behaves as follows:
- ▶ The device ignores the received query and report messages.
 - ▶ The device forwards (floods) received data packets with a Multicast address as the destination address to every port.
- Apply the settings temporarily. To do this, click the button.

Specifying the settings for a port:

- Open the *Switching > IGMP Snooping > Configuration* dialog, *Port* tab.
- To activate the *IGMP Snooping* function on a port, mark the checkbox in the *Active* column for the relevant port.
- Apply the settings temporarily. To do this, click the button.

Specifying the settings for a VLAN:

- Open the *Switching > IGMP Snooping > Configuration* dialog, *VLAN ID* tab.
- To activate the *IGMP Snooping* function for a specific VLAN, mark the checkbox in the *Active* column for the relevant VLAN.
- Apply the settings temporarily. To do this, click the button.

Setting the IGMP querier function

The device itself optionally sends active query messages. As an alternative, the device responds to query messages or detects other Multicast queriers in the network (*Querier* function).

Prerequisite:

The *IGMP Snooping* function is globally enabled.

Perform the following steps:

- Open the *Switching > IGMP Snooping > Querier* dialog.
- In the *Operation* frame, enable/disable the *Querier* function of the device globally.
- To activate the *Querier* function for a specific VLAN, mark the checkbox in the *Active* column for the relevant VLAN.
 - ▶ The device carries out a simple selection process: When the IP source address of the other Multicast querier is lower than its own, the device switches to the passive state, in which it does not send out any more query requests.
 - ▶ In the *IP address* column, you specify the IP Multicast address that the device inserts as the sender address in generated query requests. You use the address of the Multicast router.
- Apply the settings temporarily. To do this, click the button.

IGMP snooping enhancements (table)

The *Switching > IGMP Snooping > Snooping Enhancements* dialog provides you access to enhanced settings for the *IGMP Snooping* function. You activate or deactivate the settings on a per port basis in a VLAN.

The following settings are possible:

- ▶ *Static*
Use this setting to set the port as a static query port. The device forwards every IGMP message on a static query port, even if it has previously received no IGMP query messages on this port. When the static option is disabled and the device has previously received IGMP query messages, it forwards IGMP messages on this port. When this is the case, the entry displays *L* (for learned).
- ▶ *Learn by LLDP*
A port with this setting automatically discovers other Hirschmann devices using the Link Layer Discovery Protocol (LLDP). The device then learns the IGMP query status of this port from these Hirschmann devices and sets up the *Querier* function accordingly. The *ALA* entry indicates that the *Learn by LLDP* function is active. When the device has found another Hirschmann device on this port in this VLAN, the entry also displays an *A* (for automatic).
- ▶ *Forward all*
With this setting, the device forwards the data packets addressed to a Multicast address to this port. The setting is suitable in the following situations, for example:
 - For diagnostic purposes.
 - For devices in an MRP Ring: After the ring is switched, the *Forward all* function makes it possible to reconfigure the network rapidly for data packets with registered Multicast destination addresses. Activate the *Forward all* function on every ring port.

Prerequisite:

The *IGMP Snooping* function is globally enabled.

Perform the following steps:

- Open the *Switching > IGMP Snooping > Snooping Enhancements* dialog.
- Double-click the desired port in the desired VLAN.

- To activate one or more functions, select the corresponding options.
- Click the *Ok* button.
- Apply the settings temporarily. To do this, click the button.

enable

To change to the Privileged EXEC mode.

vlan database

To change to the VLAN configuration mode.

igmp-snooping vlan-id 1 forward-all 1/1

To activate the **Forward All** function for port 1/1 in VLAN 1.

Setting up Multicasts

The device lets you set up the exchange of Multicast data packets. The device provides different options depending on whether the data packets are to be sent to unknown or known Multicast receivers.

The settings for unknown Multicast addresses are global for the entire device. The following options can be selected:

- ▶ The device discards unknown multicasts.
- ▶ The device forwards unknown multicast data to every port.
- ▶ The device forwards unknown Multicasts only to ports that have previously received query messages (query ports).

Note: The exchange settings for unknown Multicast addresses also apply to the reserved IP addresses from the *Local Network Control Block* (224.0.0.0..224.0.0.255). This behavior can affect higher-level routing protocols.

IGMP Snooping explicitly ignores the following Multicast IP addresses because their mapped Multicast MAC addresses have special functions:

Table 20: Multicast IP addresses ignored by IGMP Snooping

Multicast IP address(es)	Multicast MAC address(es)	Protocols (Block)
224.0.0.0..224.0.0.255	01:00:5e:00:00:00..01:00:5e:00:00:ff	Local Network Control Block
224.0.1.1	01:00:5e:00:01:01	NTP/SNTP (Internetwork Control Block)
224.0.1.129..224.0.1.132	01:00:5e:00:01:81..01:00:5e:00:01:84	PTP (Internetwork Control Block)
239.255.16.12	01:00:5e:7f:10:0c	HiDiscovery v2 (Administratively Scoped Block)

Note: According to RFC 1112 (*Host Extensions for IP Multicasting*), up to 32 Multicast IP addresses are mapped to the same Multicast MAC address. The table contains only the commonly used Multicast IP address for a Multicast MAC address, omitting the 31 further possible Multicast IP addresses.

For each VLAN, you specify the sending of Multicast packets to known Multicast addresses individually. The following options can be selected:

- ▶ The device forwards known Multicasts to the ports that have previously received query messages (query ports) and to the registered ports. Registered ports are ports with Multicast receivers registered with the corresponding Multicast group. This option helps ensure that the transfer works with basic applications without further configuration.
- ▶ The device forwards known Multicasts only to the registered ports. The advantage of this setting is that it uses the available bandwidth optimally through direct distribution.

Prerequisite:

The *IGMP Snooping* function is globally enabled.

Perform the following steps:

- Open the *Switching > IGMP Snooping > Multicasts* dialog.
- In the *Configuration* frame, you specify how the device forwards data packets to unknown Multicast addresses.
- In the table, you specify how the device forwards data packets to known Multicast addresses.
 - ▶ *send to query and registered ports*
The device forwards data packets with a known MAC/IP Multicast address to the query ports and to the registered ports.
 - ▶ *send to registered ports*
The device forwards data packets with a known MAC/IP Multicast address to registered ports.
- Apply the settings temporarily. To do this, click the ✓ button.

10.3 Rate limiter

The rate limiter function helps ensure stable operation even with high data volumes by limiting the amount of data packets on the ports. The rate limitation is performed individually for each port, as well as separately for inbound and outbound data packets.

If the data rate on a port exceeds the defined limit, then the device discards the overload on this port.

Rate limitation occurs entirely on Layer 2. In the process, the rate limiter function ignores protocol information on higher levels such as IP or TCP. This can affect the TCP data packets.

To minimize these effects, use the following options:

- ▶ Limit the rate limitation to certain packet types, for example, Broadcasts, Multicasts, and Unicasts with an unknown destination address.
- ▶ Limit the amount of outbound data packets instead of the inbound data packets. The outbound rate limitation works better with TCP flow control due to device-internal buffering of the data packets.
- ▶ Increase the aging time for learned Unicast addresses.

Perform the following steps:

- Open the *Switching > Rate Limiter* dialog.
- ▶ Activate the rate limiter and set limits for the data rate. The settings apply on a per port basis and are separated according to the type of the data packets:
 - ▶ Received Broadcast data packets
 - ▶ Received Multicast data packets
 - ▶ Received Unicast data packets with an unknown destination addressTo activate the rate limiter on a port, mark the checkbox for at least one category. In the *Unit* column, you specify if the device interpretes the threshold values as percent of the port bandwidth or as packets per second. The threshold value 0 deactivates the rate limiter.
- Apply the settings temporarily. To do this, click the ✓ button.

10.4 QoS/Priority

QoS (Quality of Service) is a procedure defined in IEEE 802.1D which is used to distribute resources in the network. QoS lets you prioritize the data of necessary applications.

When there is a heavy network load, prioritizing helps prevent data packets with lower priority from interfering with delay-sensitive data packets. Delay-sensitive data packets include, for example, voice, video, and real-time data.

10.4.1 Description of prioritization

For data packet prioritization, *traffic classes* are defined in the device. The device prioritizes higher *traffic classes* over lower *traffic classes*. The number of *traffic classes* depends on the device type.

To provide for optimal data flow for delay-sensitive data, you assign higher *traffic classes* to this data. You assign lower *traffic classes* to data that is less sensitive to delay.

Assigning traffic classes to the data

The device automatically assigns *traffic classes* to inbound data (traffic classification). The device takes the following classification criteria into account:

- ▶ Methods according to which the device carries out assignment of received data packets to *traffic classes*:
 - ▶ *trustDot1p*
The device uses the priority of the data packet contained in the VLAN tag.
 - ▶ *trustIpDscp*
The device uses the QoS information contained in the IP header (ToS/DiffServ).
 - ▶ *untrusted*
The device ignores possible priority information within the data packets and uses the priority of the receiving port directly.
- ▶ The priority assigned to the receiving port.

Both classification criteria are configurable.

During traffic classification, the device uses the following rules:

- ▶ When the receiving port is set to *trustDot1p* (default setting), the device uses the data packet priority contained in the VLAN tag. When the data packets do not contain a VLAN tag, the device is guided by the priority of the receiving port.
- ▶ When the receiving port is set to *trustIpDscp*, the device uses the QoS information (ToS/DiffServ) in the IP header. When the data packets do not contain IP packets, the device is guided by the priority of the receiving port.
- ▶ When the receiving port is set to *untrusted*, the device is guided by the priority of the receiving port.

Prioritizing traffic classes

For prioritization of *traffic classes*, the device uses the following methods:

- ▶ *Strict Priority*
When transmission of data of a higher *traffic class* is no longer taking place or the relevant data is still in the queue, the device sends data of the corresponding *traffic class*. If every *traffic class* is prioritized according to the *Strict Priority* method, then under high network load the device can permanently block the data of lower *traffic classes*.
- ▶ *Weighted Fair Queuing*
The *traffic class* is assigned a specific bandwidth. This helps ensure that the device sends the data packets of this *traffic class*, although there is a great deal of data packets in higher *traffic classes*.

10.4.2 Handling of received priority information

Applications label data packets with the following prioritization information:

- ▶ VLAN priority according to IEEE 802.1Q (Layer 2)
- ▶ Type-of-Service (ToS) or DiffServ (DSCP) for VLAN Management IP packets (Layer 3)

The device lets you evaluate this priority information using the following options:

- ▶ *trustDot1p*
The device assigns VLAN-tagged data packets to the different *traffic classes* according to their VLAN priorities. The corresponding allocation is configurable. The device assigns the priority of the receiving port to data packets it receives without a VLAN tag.
- ▶ *trustIpDscp*
The device assigns the IP packets to the different *traffic classes* according to the DSCP value in the IP header, although the packet was also VLAN-tagged. The corresponding allocation is configurable. The device prioritizes non-IP packets according to the priority of the receiving port.
- ▶ *untrusted*
The device ignores the priority information in the data packets and assigns the priority of the receiving port to them.

10.4.3 VLAN tagging

For the VLAN and prioritizing functions, IEEE 802.1Q provides for integrating a MAC frame in the VLAN tag. The VLAN tag consists of 4 bytes and is between the source address field (“Source Address Field”) and type field (“Length / Type Field”).

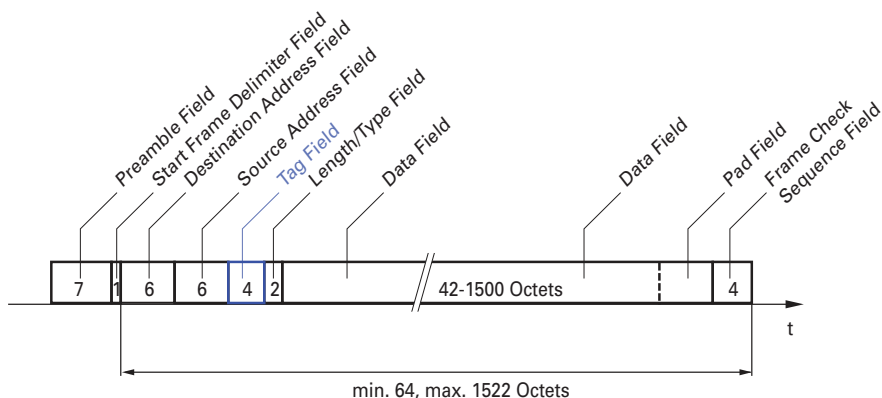

Figure 22: Ethernet data packet with tag

For data packets with VLAN tags, the device evaluates the following information:

- ▶ Priority information
- ▶ When VLANs are set up, VLAN tagging

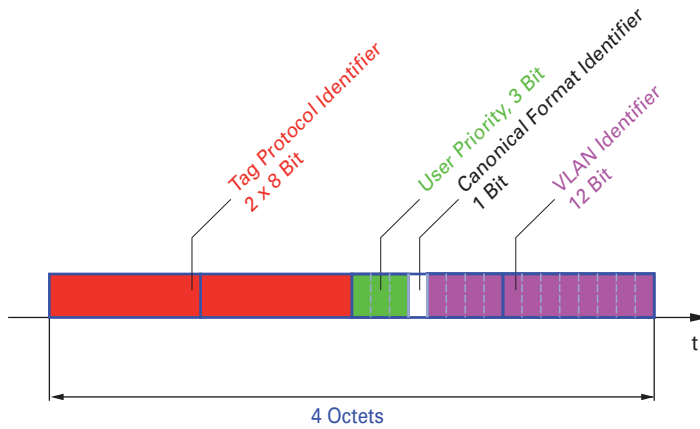

Figure 23: Structure of the VLAN tagging

A data packets with VLAN tag containing priority information but no VLAN information (VLAN ID = 0), is known as a *Priority Tagged* frame.

Note: Network protocols and redundancy mechanisms use the highest *traffic class* 7. Therefore, select other *traffic classes* for application data.

When using VLAN prioritizing, consider the following special features:

- ▶ End-to-end prioritizing requires the VLAN tags to be transmitted to the entire network. The prerequisite is that every network component is VLAN-capable.
- ▶ Routers are not able to send and receive packets with VLAN tags through port-based router interfaces.

10.4.4 IP ToS (Type of Service)

The Type-of-Service field (ToS) in the IP header was already part of the IP protocol from the start, and is used to differentiate different services in IP networks. Even back then, there were ideas about differentiated treatment of IP packets, due to the limited bandwidth available and the unreliable connection paths. Because of the continuous increase in the available bandwidth, there was no need to use the ToS field.

Only with the real-time requirements of today's networks has the ToS field become significant again. Selecting the ToS byte of the IP header lets you differentiate between different services. However, this field is not widely used in practice.

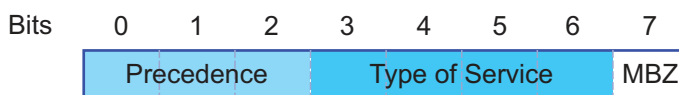

Table 21: ToS field in the IP header

Bits (0-2): IP Precedence Defined	Bits (3-6): Type of Service Defined	Bit (7)
111 - Network Control	0000 - [all normal]	0 - Zero
110 - Internetwork Control	1000 - [minimize delay]	
101 - CRITIC / ECP	0100 - [maximize throughput]	

Table 21: ToS field in the IP header (cont.)

Bits (0-2): IP Precedence Defined	Bits (3-6): Type of Service Defined	Bit (7)
100 - Flash Override	0010 - [maximize reliability]	
011 - Flash	0001 - [minimize monetary cost]	
010 - Immediate		
001 - Priority		
000 - Routine		

10.4.5 Handling of traffic classes

The device provides the following options for handling *traffic classes*:

- ▶ *Strict Priority*
- ▶ *Weighted Fair Queuing*
- ▶ *Strict Priority* combined with *Weighted Fair Queuing*
- ▶ Queue management

Strict Priority description

With the *Strict Priority* setting, the device first transmits data packets that have a higher *traffic class* (higher priority) before transmitting a data packet with the next highest *traffic class*. When there are no other data packets remaining in the queue, the device transmits a data packet with the lowest *traffic class* (lowest priority). In unfortunate cases, if there is a high volume of high-priority data packets waiting to be sent on this port, then the device does not send data packets with a low priority.

In delay-sensitive applications, such as VoIP or video, *Strict Priority* lets data to be sent immediately.

Weighted Fair Queuing description

With *Weighted Fair Queuing*, also called *Weighted Round Robin (WRR)*, you assign a minimum or reserved bandwidth to each *traffic class*. This helps ensure that data packets with a lower priority are also sent although the network is very busy.

The reserved values range from 0% through 100% of the available bandwidth, in steps of 1%.

- ▶ A reservation of 0 is equivalent to a "no bandwidth" setting.
- ▶ The sum of the individual bandwidths can be up to 100%.

When you assign *Weighted Fair Queuing* to every *traffic class*, the entire bandwidth of the corresponding port is available to you.

Combining Strict Priority and Weighted Fair Queuing

When combining *Weighted Fair Queuing* with *Strict Priority*, verify that the highest *traffic class* of *Weighted Fair Queuing* is lower than the lowest *traffic class* of *Strict Priority*.

If you combine *Weighted Fair Queuing* with *Strict Priority*, then a high *Strict Priority* network load can significantly reduce the bandwidth available for *Weighted Fair Queuing*.

10.4.6 Queue management

Queue Shaping

Queue Shaping throttles the rate at which queues transmit packets. For example, using Queue Shaping, you rate-limit a higher strict-priority queue so that it lets a lower strict-priority queue to send packets even though higher priority packets are still available for transmission. The device lets you setup Queue Shaping for any queue. You specify Queue Shaping as the maximum rate at which the data packets pass through a queue by assigning a percentage of the available bandwidth.

Defining settings for queue management

Perform the following steps:

- Open the *Switching > QoS/Priority > Queue Management* dialog.
The total assigned bandwidth in the *Min. bandwidth [%]* column is 100%.
- To activate *Weighted Fair Queuing* for *Traffic class* = 0, proceed as follows:
 - ▶ Unmark the checkbox in the *Strict priority* column.
 - ▶ In the *Min. bandwidth [%]* column, specify the value 5.
- To activate *Weighted Fair Queuing* for *Traffic class* = 1, proceed as follows:
 - ▶ Unmark the checkbox in the *Strict priority* column.
 - ▶ In the *Min. bandwidth [%]* column, specify the value 20.
- To activate *Weighted Fair Queuing* for *Traffic class* = 2, proceed as follows:
 - ▶ Unmark the checkbox in the *Strict priority* column.
 - ▶ In the *Min. bandwidth [%]* column, specify the value 30.
- To activate *Weighted Fair Queuing* for *Traffic class* = 3, proceed as follows:
 - ▶ Unmark the checkbox in the *Strict priority* column.
 - ▶ In the *Min. bandwidth [%]* column, specify the value 20.
- To activate *Weighted Fair Queuing* and Queue Shaping for *Traffic class* = 4, proceed as follows:
 - ▶ Unmark the checkbox in the *Strict priority* column.
 - ▶ In the *Min. bandwidth [%]* column, specify the value 10.
 - ▶ In the *Max. bandwidth [%]* column, specify the value 10.

When using a *Weighted Fair Queuing* and Queue Shaping combination for a specific *traffic class*, specify a higher value in the *Max. bandwidth [%]* column than the value specified in the *Min. bandwidth [%]* column.
- To activate *Weighted Fair Queuing* for *Traffic class* = 5, proceed as follows:
 - ▶ Unmark the checkbox in the *Strict priority* column.
 - ▶ In the *Min. bandwidth [%]* column, specify the value 5.

- To activate *Weighted Fair Queuing* for *Traffic class* = 6, proceed as follows:
 - ▶ Unmark the checkbox in the *Strict priority* column.
 - ▶ In the *Min. bandwidth [%]* column, specify the value 10.
- To activate *Strict Priority* and Queue Shaping for *Traffic class* = 7, proceed as follows:
 - ▶ Mark the checkbox in the *Strict priority* column.
 - ▶ In the *Max. bandwidth [%]* column, specify the value 10.
- Apply the settings temporarily. To do this, click the ✓ button.

```

enable
configure
cos-queue weighted 0

cos-queue min-bandwidth: 0 5
cos-queue weighted 1

cos-queue min-bandwidth: 1 20
cos-queue weighted 2

cos-queue min-bandwidth: 2 30
cos-queue weighted 3

cos-queue min-bandwidth: 3 20
show cos-queue
Queue Id  Min. bandwidth  Max. bandwidth  Scheduler type
-----  -
0         5                0                weighted
1         20               0                weighted
2         30               0                weighted
3         20               0                weighted
4         0                0                strict
5         0                0                strict
6         0                0                strict
7         0                0                strict

```

To change to the Privileged EXEC mode.

To change to the Configuration mode.

To enable *Weighted Fair Queuing* for *traffic class* 0.

To assign a weight of 5 % to *traffic class* 0.

To enable *Weighted Fair Queuing* for *traffic class* 1.

To assign a weight of 20 % to *traffic class* 1.

To enable *Weighted Fair Queuing* for *traffic class* 2.

To assign a weight of 30 % to *traffic class* 2.

To enable *Weighted Fair Queuing* for *traffic class* 3.

To assign a weight of 20 % to *traffic class* 3.

Combining Weighted Fair Queuing and Queue Shaping

Perform the following steps:

```

enable
configure
cos-queue weighted 4

cos-queue min-bandwidth: 4 10
cos-queue max-bandwidth: 4 10
cos-queue weighted 5

cos-queue min-bandwidth: 5 5

```

To change to the Privileged EXEC mode.

To change to the Configuration mode.

To enable *Weighted Fair Queuing* for *traffic class* 4.

To assign a weight of 10 % to *traffic class* 4.

To assign a weight of 10 % to *traffic class* 4.

To enable *Weighted Fair Queuing* for *traffic class* 5.

To assign a weight of 5 % to *traffic class* 5.

```

cos-queue weighted 6
cos-queue min-bandwidth: 6 10
show cos-queue
Queue Id  Min. bandwidth  Scheduler type
-----  -
0         5                0             weighted
1         20               0             weighted
2         30               0             weighted
3         20               0             weighted
4         10               10            weighted
5         5                0             weighted
6         10               0             weighted
7         0                0             strict

```

To enable *Weighted Fair Queuing* for *traffic class 6*.

To assign a weight of **10 %** to *traffic class 6*.

Setting up Queue Shaping

Perform the following steps:

```

enable
configure
cos-queue max-bandwidth: 7 10
show cos-queue
Queue Id  Min. bandwidth  Scheduler type
-----  -
0         5                0             weighted
1         20               0             weighted
2         30               0             weighted
3         20               0             weighted
4         10               10            weighted
5         5                0             weighted
6         10               0             weighted
7         0                10            strict

```

To change to the Privileged EXEC mode.

To change to the Configuration mode.

To assign a weight of **10 %** to *traffic class 7*.

10.4.7 Management prioritization

The device lets you prioritize the management packets so that you can access the device management at any time in situations with high network load.

When prioritizing management packets, the device sends the management packets with priority information.

- ▶ On Layer 2, the device modifies the VLAN priority in the VLAN tag.
The prerequisite for this function is that the corresponding ports are set to allow sending packets with a VLAN tag.
- ▶ On Layer 3, the device modifies the IP-DSCP value.

10.4.8 Setting prioritization

Assigning the Port priority

Perform the following steps:

- Open the *Switching > QoS/Priority > Port Configuration* dialog.
- In the *Port priority* column, you specify the priority with which the device forwards the data packets received on this port without a VLAN tag.
- In the *Trust mode* column, you specify the criteria the device uses to assign a *traffic class* to data packets received.
- Apply the settings temporarily. To do this, click the ✓ button.

enable	To change to the Privileged EXEC mode.
configure	To change to the Configuration mode.
interface 1/1	To change to the interface configuration mode of interface 1/1.
vlan priority 3	To assign interface 1/1 the <i>Port priority</i> 3.
exit	To change to the Configuration mode.

Assigning VLAN priority to a traffic class

Perform the following steps:

- Open the *Switching > QoS/Priority > 802.1D/p Mapping* dialog.
- To assign a *traffic class* to a VLAN priority, insert the associated value in the *Traffic class* column.
- Apply the settings temporarily. To do this, click the ✓ button.

enable	To change to the Privileged EXEC mode.
configure	To change to the Configuration mode.
classofservice dot1p-mapping 0 2	To assign a VLAN priority of 0 to <i>traffic class</i> 2.
classofservice dot1p-mapping 1 2	To assign a VLAN priority of 1 to <i>traffic class</i> 2.
exit	To change to the Privileged EXEC mode.
show classofservice dot1p-mapping	To display the assignment.

Assigning Port priority to received data packets

Perform the following steps:

```
enable
configure
interface 1/1

classofservice trust untrusted
classofservice dot1p-mapping 0 2
classofservice dot1p-mapping 1 2
vlan priority 1
exit
exit
show classofservice trust

Interface Trust Mode
-----
1/1      untrusted
1/2      dot1p
1/3      dot1p
1/4      dot1p
1/5      dot1p
1/6      dot1p
1/7      dot1p
```

To change to the Privileged EXEC mode.

To change to the Configuration mode.

To change to the interface configuration mode of interface `1/1`.

To assign the `untrusted` mode to the interface.

To assign a VLAN priority of `0` to *traffic class 2*.

To assign a VLAN priority of `1` to *traffic class 2*.

To specify the value `1` for the *Port priority*.

To change to the Configuration mode.

To change to the Privileged EXEC mode.

To display the Trust mode of the ports/interfaces.

Assigning DSCP to a traffic class

Perform the following steps:

- Open the [Switching > QoS/Priority > IP DSCP Mapping](#) dialog.
- Specify the desired value in the *Traffic class* column.
- Apply the settings temporarily. To do this, click the button.

```
enable
configure
classofservice ip-dscp-mapping cs1 1
show classofservice ip-dscp-mapping

IP DSCP      Traffic Class
-----
be           2
1            2
.            .
.            .
(cs1)       1
.            .
```

To change to the Privileged EXEC mode.

To change to the Configuration mode.

To assign the DSCP value `CS1` to *traffic class 1*.

To display the IP DSCP assignments

Assigning the DSCP priority to received IP data packets

Perform the following steps:

```
enable
configure
interface 1/1

classofservice trust ip-dscp
exit
show classofservice trust

Interface    Trust Mode
-----
1/1          ip-dscp
1/2          dot1p
1/3          dot1p
.
.
1/5          dot1p
.
```

To change to the Privileged EXEC mode.
To change to the Configuration mode.
To change to the interface configuration mode of interface 1/1.
To assign the `trust ip-dscp` mode globally.
To change to the Configuration mode.
To display the Trust mode of the ports/interfaces.

Configuring traffic shaping on a port

Perform the following steps:

```
enable
configure
interface 1/2

traffic-shape bw 50

exit
exit
show traffic-shape

Interface    Shaping rate
-----
1/1          0 %
1/2          50 %
1/3          0 %
1/4          0 %
```

To change to the Privileged EXEC mode.
To change to the Configuration mode.
To change to the interface configuration mode of interface 1/2.
To limit the maximum bandwidth of the port 1/2 to 50%.
To change to the Configuration mode.
To change to the Privileged EXEC mode.
To display the Traffic Shaping configuration.

Configuring Layer 2 management priority

Perform the following steps:

- Open the *Switching > QoS/Priority > Global* dialog.
- In the *VLAN priority for management packets* field, specify the VLAN priority with which the device sends management data packets.
- Apply the settings temporarily. To do this, click the button.

```
enable
network management priority dot1p 7
```

To change to the Privileged EXEC mode.

To assign the VLAN priority of 7 to management packets. The device sends management packets with the highest priority.

```
show network parms
```

To display the priority of the VLAN in which the device management is located.

```
IPv4 Network
-----
...
Management VLAN priority.....7
...
```

Configuring Layer 3 management priority

Perform the following steps:

- Open the *Switching > QoS/Priority > Global* dialog.
- In the *IP DSCP value for management packets* field, specify the DSCP value with which the device sends management data packets.
- Apply the settings temporarily. To do this, click the button.

```
enable
network management priority ip-dscp 56
```

To change to the Privileged EXEC mode.

To assign the DSCP value of 56 to management packets. The device sends management packets with the highest priority.

```
show network parms
```

To display the priority of the VLAN in which the device management is located.

```
IPv4 Network
-----
...
Management IP-DSCP value.....56
```

10.5 Flow control

If a large number of data packets are received in the priority queue of a port at the same time, then this can cause the port memory to overflow. This happens, for example, when the device receives data on a Gigabit port and forwards it to a port with a lower bandwidth. The device discards superfluous data packets.

The flow control mechanism defined in IEEE 802.3 helps ensure that no data packets are lost due to buffer overflow on a port. Shortly before the buffer memory of a port is completely full, the device signals to the connected devices that it is not accepting any more data packets from them.

- ▶ In full-duplex mode, the device sends a pause data packet.
- ▶ In half-duplex mode, the device simulates a collision.

The following figure displays how flow control works. Workstations 1, 2, and 3 want to simultaneously transmit a large amount of data to Workstation 4. The combined bandwidth of Workstations 1, 2, and 3 is greater than the bandwidth of Workstation 4. This causes an overflow on the receive queue of port 4. The left funnel symbolizes this status.

When the flow control function on ports 1, 2 and 3 of the device is enabled, the device reacts before the funnel overflows. The funnel on the right illustrates ports 1, 2 and 3 sending a message to the transmitting devices to control the transmission speed. This results in the receiving port no longer being overwhelmed and is able to process the incoming data packets.

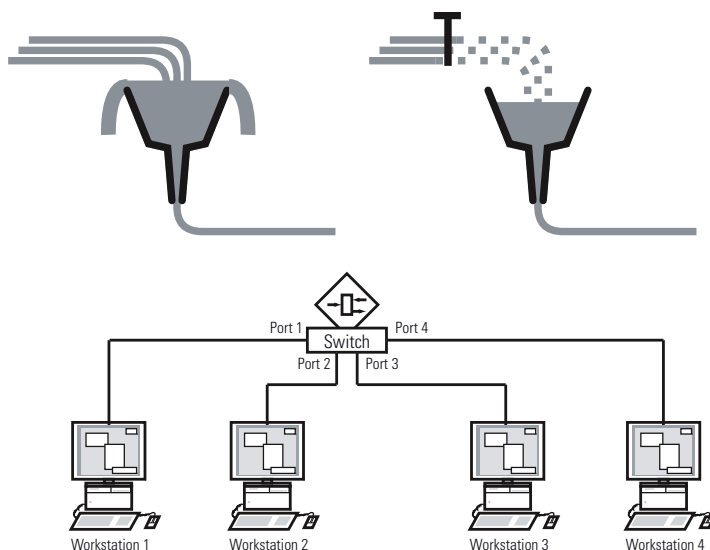

Figure 24: Example of flow control

10.5.1 Flow Control with a half-duplex link

In the example, there is a half-duplex link between Workstation 2 and the device.

Before the send queue of port 2 overflows, the device sends data back to Workstation 2. Workstation 2 detects a collision and stops transmitting.

10.5.2 Flow Control with a full-duplex link

In the example, there is a full-duplex link between Workstation 2 and the device.

Before the send queue of port 2 overflows, the device sends a request to Workstation 2 to include a small break in the sending transmission.

10.5.3 Setting up the Flow Control

Perform the following steps:

- Open the *Switching > Global* dialog.
- Mark the *Flow control* checkbox.
With this setting you enable flow control in the device.
- Open the *Basic Settings > Port* dialog, *Configuration* tab.
- To enable the Flow Control on a port, mark the checkbox in the *Flow control* column.
- Apply the settings temporarily. To do this, click the  button.

Note: When you are using a redundancy function, you deactivate the flow control on the participating ports. If the flow control and the redundancy function are active at the same time, it is possible that the redundancy function operates differently than intended.

11 VLANs

In the simplest case, a virtual LAN (VLAN) consists of a group of network participants in one network segment who can communicate with each other as though they belonged to a separate LAN.

More complex VLANs span out over multiple network segments and are also based on logical (instead of only physical) connections between network participants. VLANs are an element of flexible network design. It is easier to reconfiguring logical connections centrally than cable connections.

The device supports independent VLAN learning according to IEEE 802.1Q which defines the *VLAN* function.

Using VLANs has many benefits. The following list displays the top benefits:

- ▶ Network load limiting
VLANs reduce the network load considerably as the devices transmit Broadcast, Multicast, and Unicast packets with unknown (unlearned) destination addresses only inside the virtual LAN. The rest of the data network forwards the data packets as normal.
- ▶ Flexibility
You have the option of forming user groups based on the function of the participants apart from their physical location or medium.
- ▶ Clarity
VLANs give networks a clear structure and make maintenance easier.

11.1 Examples of VLANs

The following practical examples provide a quick introduction to the structure of a VLAN.

Note: When configuring VLANs you use an interface for accessing the device management that will remain unchanged. For this example, you use either interface 1/6 or the serial connection to set up the VLANs.

11.1.1 Application example of a simple port-based VLAN

The example displays a minimal VLAN configuration (port-based VLAN). An administrator has connected multiple end devices to a transmission device and assigned them to 2 VLANs. This effectively prohibits any data transmission between the VLANs, whose members communicate only within their own VLANs.

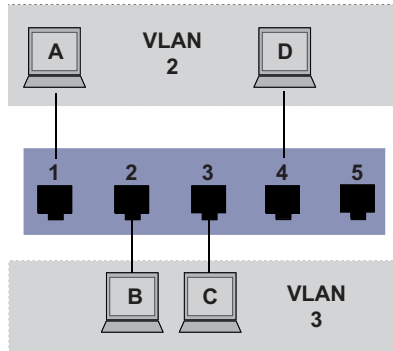

Figure 25: Example of a simple port-based VLAN

When setting up the VLANs, you add communication rules for every port, which you set up in ingress (incoming) and egress (outgoing) tables.

The ingress table specifies which VLAN ID a port assigns to the incoming data packets. Hereby, you use the port address of the end device to assign it to a VLAN.

The egress table specifies on which ports the device sends the packets from this VLAN.

- ▶ T = Tagged (with a tag field, marked)
- ▶ U = Untagged (without a tag field, unmarked)

For this example, the status of the TAG field of the data packets has no relevance, so you use the setting U.

Table 22: Ingress table

Terminal	Port	Port VLAN identifier (PVID)
A	1	2
B	2	3
C	3	3
D	4	2
	5	1

Table 23: Egress table

VLAN ID	Port				
	1	2	3	4	5
1					U
2	U			U	
3		U	U		

Perform the following steps:

Setting up the VLAN

- Open the *Switching > VLAN > Configuration* dialog.
- Click the  button.
The dialog displays the *Create* window.
- In the *VLAN ID* field, specify the value *2*.
- Click the *Ok* button.
- For the VLAN, specify the name *VLAN2*:
Double-click in the *Name* column and specify the name.
For VLAN *1*, in the *Name* column, change the value *Default* to *VLAN1*.
- Repeat the previous steps to add VLAN *3* with the name *VLAN3*.

```
enable
vlan database
vlan add 2
name 2 VLAN2
vlan add 3
name 3 VLAN3
name 1 VLAN1
exit
show vlan brief
Max. VLAN ID..... 4042
Max. supported VLANs..... 512
Number of currently configured VLANs..... 3
vlan unaware mode..... disabled
VLAN ID VLAN Name          VLAN Type VLAN Creation Time
-----
1      VLAN1                default   0 days, 00:00:05
2      VLAN2                static    0 days, 02:44:29
3      VLAN3                static    0 days, 02:52:26
```

To change to the Privileged EXEC mode.

To change to the VLAN configuration mode.

To add VLAN *2*.

To assign the name *2* to the VLAN *VLAN2*.

To add VLAN *3*.

To assign the name *3* to the VLAN *VLAN3*.

To assign the name *1* to the VLAN *VLAN1*.

To change to the Privileged EXEC mode.

To display the current VLAN configuration.

Setting up the ports

- Open the *Switching > VLAN > Configuration* dialog.
- To assign the port to a VLAN, specify the desired value in the corresponding column.
Possible values:
 - ▶ *T* = The port is a member of the VLAN. The port transmits tagged data packets.
 - ▶ *U* = The port is a member of the VLAN. The port transmits untagged data packets.
 - ▶ *F* = The port is not a member of the VLAN.
Changes using the *GVRP* function are disabled.
 - ▶ *-* = The port is not a member of this VLAN.
Changes using the *GVRP* function are allowed.
Because end devices usually interpret untagged data packets, you specify the value *U*.
- Apply the settings temporarily. To do this, click the  button.
- Open the *Switching > VLAN > Port* dialog.

- In the *Port-VLAN ID* column, specify the related VLAN: 2 or 3
- Because end devices usually interpret untagged data packets, in the *Acceptable packet types* column, you specify the value *admitALL* for end device ports.
- Apply the settings temporarily. To do this, click the ✓ button.

The value in the *Ingress filtering* column has no affect on how this example functions.

```
enable
configure
interface 1/1

vlan participation include 2

vlan pvid 2
exit
interface 1/2

vlan participation include 3

vlan pvid 3
exit
interface 1/3

vlan participation include 3

vlan pvid 3
exit
interface 1/4

vlan participation include 2

vlan pvid 2
exit
exit
show vlan id 3
```

To change to the Privileged EXEC mode.
To change to the Configuration mode.
To change to the interface configuration mode of interface 1/1.
The port 1/1 becomes a member of the VLAN 2 and transmits the data packets without a VLAN tag.
To assign the Port VLAN ID 1/1 to port 2.
To change to the Configuration mode.
To change to the interface configuration mode of interface 1/2.
The port 1/2 becomes a member of the VLAN 3 and transmits the data packets without a VLAN tag.
To assign the Port VLAN ID 1/2 to port 3.
To change to the Configuration mode.
To change to the interface configuration mode of interface 1/3.
The port 1/3 becomes a member of the VLAN 3 and transmits the data packets without a VLAN tag.
To assign the Port VLAN ID 1/3 to port 3.
To change to the Configuration mode.
To change to the interface configuration mode of interface 1/4.
The port 1/4 becomes a member of the VLAN 2 and transmits the data packets without a VLAN tag.
To assign the Port VLAN ID 1/4 to port 2.
To change to the Configuration mode.
To change to the Privileged EXEC mode.
To display details for VLAN 3.

VLAN ID	Current	Configured	Tagging
1/1	-	Autodetect	Tagged
1/2	Include	Include	Untagged
1/3	Include	Include	Untagged
1/4	-	Autodetect	Tagged
1/5	-	Autodetect	Tagged

11.1.2 Application example of a complex VLAN setup

The second example displays a more complex configuration with 3 VLANs (1 to 3). Along with the Switch from example 1, you use a second Switch (on the right in the example).

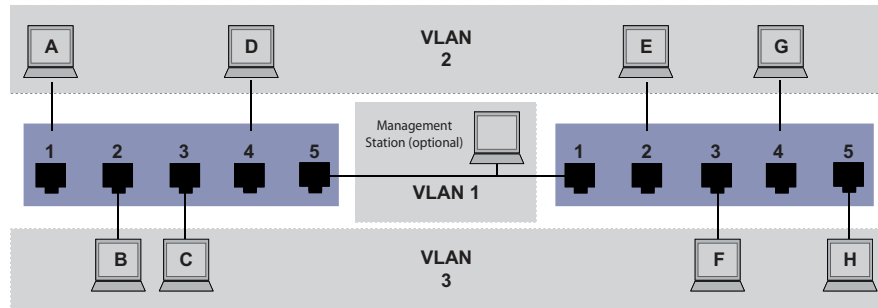

Figure 26: Example of a more complex VLAN configuration

The terminal devices (A to H) of the individual VLANs are spread over 2 transmission devices (Switches). Such VLANs are therefore known as distributed VLANs. An optional network management station is also shown, which has access to the device management of each network component if the associated VLAN is set up correctly.

Note: In this case, VLAN 1 has no significance for the end device communication, but it is required for the administration of the transmission devices through what is known as the Management VLAN.

As in the previous example, uniquely assign the ports with their connected terminal devices to a VLAN. With the direct connection between both transmission devices (uplink), the ports transport packets for both VLANs. To differentiate these uplinks you use “VLAN tagging”, which handles the data packets accordingly. Thus, you maintain the assignment to the respective VLANs.

Perform the following steps:

- Add Uplink Port 5 to the ingress and egress tables from example 1.
- Create new ingress and egress tables for the right switch, as described in the first example.

The egress table specifies on which ports the device sends the packets from this VLAN.

- ▶ T = Tagged (with a tag field, marked)
- ▶ U = Untagged (without a tag field, unmarked)

In this example, tagged packets are used in the communication between the transmission devices (Uplink), as packets for different VLANs are differentiated at these ports.

Table 24: Ingress table for device on left

Terminal	Port	Port VLAN identifier (PVID)
A	1	2
B	2	3
C	3	3
D	4	2
Uplink	5	1

Table 25: Ingress table for device on right

Terminal	Port	Port VLAN identifier (PVID)
Uplink	1	1
E	2	2
F	3	3
G	4	2
H	5	3

Table 26: Egress table for device on left

VLAN ID	Port				
	1	2	3	4	5
1					U
2	U			U	T
3		U	U		T

Table 27: Egress table for device on right

VLAN ID	Port				
	1	2	3	4	5
1	U				
2	T	U		U	
3	T		U		U

The communication relationships here are as follows: end devices on ports 1 and 4 of the left device and end devices on ports 2 and 4 of the right device are members of VLAN 2 and can thus communicate with each other. The behavior is the same for the end devices on ports 2 and 3 of the left device and the end devices on ports 3 and 5 of the right device. These belong to VLAN 3.

The end devices “see” their respective part of the network. Participants outside this VLAN cannot be reached. The device also sends Broadcast, Multicast, and Unicast packets with unknown (unlearned) destination addresses only inside a VLAN.

Here, the devices use VLAN tagging (IEEE 801.1Q) within the VLAN with the ID 1 (Uplink). The letter T in the egress table of the ports indicates VLAN tagging.

The configuration of the example is the same for the device on the right. Proceed in the same way, using the ingress and egress tables specified above to adapt the previously set up left device to the new environment.

Perform the following steps:

- Setting up the VLAN
 - Open the [Switching > VLAN > Configuration](#) dialog.
 - Click the  button.
The dialog displays the [Create](#) window.
 - In the [VLAN ID](#) field, specify the VLAN, for example 2.

- Click the *Ok* button.
- For the VLAN, specify the name *VLAN2*:
Double-click in the *Name* column and specify the name.
For VLAN 1, in the *Name* column, change the value *Default* to *VLAN1*.
- Repeat the previous steps to add VLAN 3 with the name *VLAN3*.

```
enable
vlan database
vlan add 2
name 2 VLAN2
vlan add 3
name 3 VLAN3
name 1 VLAN1
exit
show vlan brief
```

Max. VLAN ID..... 4042
Max. supported VLANs..... 512
Number of currently configured VLANs..... 3
vlan unaware mode..... disabled

VLAN ID	VLAN Name	VLAN Type	VLAN Creation Time
1	VLAN1	default	0 days, 00:00:05
2	VLAN2	static	0 days, 02:44:29
3	VLAN3	static	0 days, 02:52:26

Setting up the ports

- Open the *Switching > VLAN > Configuration* dialog.
- To assign the port to a VLAN, specify the desired value in the corresponding column.
Possible values:
 - ▶ **T** = The port is a member of the VLAN. The port transmits tagged data packets.
 - ▶ **U** = The port is a member of the VLAN. The port transmits untagged data packets.
 - ▶ **F** = The port is not a member of the VLAN.
Changes using the *GVRP* function are disabled.
 - ▶ **-** = The port is not a member of this VLAN.
Changes using the *GVRP* function are disabled.
Because end devices usually interpret untagged data packets, you specify the value **U**.
You specify the **T** setting on the uplink port on which the VLANs communicate with each other.
- Apply the settings temporarily. To do this, click the button.
- Open the *Switching > VLAN > Port* dialog.
- In the *Port-VLAN ID* column, specify the related VLAN:
1, 2 or 3
- Because end devices usually interpret untagged data packets, in the *Acceptable packet types* column, you specify the value *admitAll* for end device ports.

- For the uplink port, in the *Acceptable packet types* column, specify the value *admitOnlyVlanTagged*.
- Mark the checkbox in the *Ingress filtering* column for the uplink ports to evaluate VLAN tags on this port.
- Apply the settings temporarily. To do this, click the ✓ button.

enable	To change to the Privileged EXEC mode.
configure	To change to the Configuration mode.
interface 1/1	To change to the interface configuration mode of interface 1/1.
vlan participation include 1	The port 1/1 becomes a member of the VLAN 1 and transmits the data packets without a VLAN tag.
vlan participation include 2	The port 1/1 becomes a member of the VLAN 2 and transmits the data packets without a VLAN tag.
vlan tagging 2 enable	The port 1/1 becomes a member of the VLAN 2 and transmits the data packets with a VLAN tag.
vlan participation include 3	The port 1/1 becomes a member of the VLAN 3 and transmits the data packets without a VLAN tag.
vlan tagging 3 enable	The port 1/1 becomes a member of the VLAN 3 and transmits the data packets with a VLAN tag.
vlan pvid 1	To assign the Port VLAN ID 1 to port 1/1.
vlan ingressfilter	To activate ingress filtering on port 1/1.
vlan acceptframe vlanonly	Port 1/1 only forwards packets with a VLAN tag.
exit	To change to the Configuration mode.
interface 1/2	To change to the interface configuration mode of interface 1/2.
vlan participation include 2	The port 1/2 becomes a member of the VLAN 2 and transmits the data packets without a VLAN tag.
vlan pvid 2	To assign the Port VLAN ID 2 to port 1/2.
exit	To change to the Configuration mode.
interface 1/3	To change to the interface configuration mode of interface 1/3.
vlan participation include 3	The port 1/3 becomes a member of the VLAN 3 and transmits the data packets without a VLAN tag.
vlan pvid 3	To assign the Port VLAN ID 3 to port 1/3.
exit	To change to the Configuration mode.
interface 1/4	To change to the interface configuration mode of interface 1/4.
vlan participation include 2	The port 1/4 becomes a member of the VLAN 2 and transmits the data packets without a VLAN tag.
vlan pvid 2	To assign the Port VLAN ID 2 to port 1/4.
exit	To change to the Configuration mode.
interface 1/5	To change to the interface configuration mode of interface 1/5.
vlan participation include 3	The port 1/5 becomes a member of the VLAN 3 and transmits the data packets without a VLAN tag.
vlan pvid 3	To assign the Port VLAN ID 3 to port 1/5.

```

exit
exit
show vlan id 3
VLAN ID.....3
VLAN Name.....VLAN3
VLAN Type.....Static
VLAN Creation Time.....0 days, 00:07:47 (System Uptime)
VLAN Routing.....disabled

```

To change to the Configuration mode.

To change to the Privileged EXEC mode.

To display details for VLAN 3.

Interface	Current	Configured	Tagging
1/1	Include	Include	Tagged
1/2	-	Autodetect	Untagged
1/3	Include	Include	Untagged
1/4	-	Autodetect	Untagged
1/5	Include	Include	Untagged

11.2 Guest VLAN / Unauthenticated VLAN

A Guest VLAN lets a device provide port-based Network Access Control (IEEE 802.1x) to non-802.1x capable supplicants. This feature provides a mechanism to allow guests to access external networks only. If you connect non-802.1x capable supplicants to an active unauthorized 802.1x port, then the supplicants send no responses to 802.1x requests. Since the supplicants send no responses, the port remains in the unauthorized state. The supplicants have no access to external networks.



The Guest VLAN supplicant is a per-port basis configuration. When you set up a Guest VLAN on a port and connect non-802.1x capable supplicants to this port, the device assigns the supplicants to the Guest VLAN. Adding supplicants to a Guest VLAN causes the port to change to the authorized state allowing the supplicants to access to external networks.

An Unauthenticated VLAN lets the device provide service to 802.1x capable supplicants which authenticate incorrectly. This function lets the unauthorized supplicants have access to limited services. If you set up an Unauthenticated VLAN on a port with 802.1x port authentication and the global operation enabled, then the device places the port in an Unauthenticated VLAN. When a 802.1x capable supplicant incorrectly authenticates on the port, the device adds the supplicant to the Unauthenticated VLAN. If you also set up a Guest VLAN on the port, then non-802.1x capable supplicants use the Guest VLAN.

If the port has an Unauthenticated VLAN assigned, then the reauthentication timer counts down. When the time specified in the *Reauthentication period [s]* column expires and supplicants are present on the port, the Unauthenticated VLAN reauthenticates. When no supplicants are present, the device places the port in the set-up Guest VLAN.

The following example explains how to add a Guest VLAN. Add an Unauthorized VLAN in the same manner.

Perform the following steps:

- Open the *Switching > VLAN > Configuration* dialog.
- Click the  button.
The dialog displays the *Create* window.
- In the *VLAN ID* field, specify the value *10*.
- Click the *Ok* button.
- For the VLAN, specify the name *Guest*:
Double-click in the *Name* column and specify the name.
- Click the  button.
The dialog displays the *Create* window.
- In the *VLAN ID* field, specify the value *20*.
- Click the *Ok* button.
- For the VLAN, specify the name *Not authorized*:
Double-click in the *Name* column and specify the name.
- Open the *Network Security > 802.1X > Global* dialog.
- To enable the function, select the *On* radio button in the *Operation* frame.
- Apply the settings temporarily. To do this, click the  button.

- Open the *Network Security > 802.1X > Port Configuration* dialog.
- Specify the following settings for port 1/4:
 - The value *auto* in the *Port control* column
 - The value *10* in the *Guest VLAN ID* column
 - The value *20* in the *Unauthenticated VLAN ID* column
- Apply the settings temporarily. To do this, click the button.

```
enable
vlan database
vlan add 10
vlan add 20
name 10 Guest
name 20 Unauth
exit
configure
dot1x system-auth-control enable
dot1x port-control auto
interface 1/4

dot1x guest-vlan 10
dot1x unauthenticated-vlan 20
exit
```

To change to the Privileged EXEC mode.

To change to the VLAN configuration mode.

To add VLAN *10*.

To add VLAN *20*.

To rename VLAN *10* to *Guest*.

To rename VLAN *20* to *Unauth*.

To change to the Privileged EXEC mode.

To change to the Configuration mode.

To enable the *802.1X* function globally.

To enable port control on port *1/4*.

To change to the interface configuration mode of interface *1/4*.

To assign the guest vlan to port *1/4*.

To assign the unauthorized vlan to port *1/4*.

To change to the Configuration mode.

11.3 RADIUS VLAN assignment

The RADIUS VLAN assignment feature makes it possible for a RADIUS VLAN ID attribute to be associated with an authenticated client. When a client authenticates successfully, and the RADIUS server sends a VLAN attribute, the device associates the client with the RADIUS assigned VLAN. As a result, the device adds the physical port as a member to the appropriate VLAN and sets the port VLAN ID (PVID) with the given value. The port transmits the data packets without a VLAN tag.

11.4 Creating a Voice VLAN

Use the Voice VLAN feature to separate voice and data packets on a port, by VLAN and/or priority. A significant benefit of the voice VLAN is that a high volume of data on the port does not affect the sound quality of an IP phone.

The device uses the source MAC address to identify and prioritize the voice data flow. Identifying by MAC address reduces the potential for a "rogue client" to connect to the port and manipulate voice data packets.

Another benefit of the Voice VLAN feature is that a VoIP phone obtains a VLAN ID or priority information using LLDP-MED. As a result, the VoIP phone sends voice data packets with VLAN tag, priority tag or untagged. This depends on the Voice VLAN Interface configuration.

The following Voice VLAN interface modes are possible. The first 3 methods segregate and prioritize voice and data packets. The segregation of the data packets improves the quality of the voice data stream in case of high data volumes.

- ▶ Configuring the port to using the *vlan* mode lets the device tag the voice data coming from a VoIP phone with the user-defined voice VLAN ID. The device assigns regular data to the default port VLAN ID.
- ▶ Configuring the port to use the *dot1p-priority* mode lets the device tag the data coming from a VoIP phone with VLAN 0 and the user-defined priority. The device assigns the default priority of the port to regular data.
- ▶ Specify both the voice VLAN ID and the priority using the *vlan/dot1p-priority* mode. In this mode the VoIP phone sends voice data with the user-defined voice VLAN ID and priority information. The device assigns the default PVID and priority of the port to regular data.
- ▶ When set up as *untagged*, the phone sends untagged packets.
- ▶ When set up as *none*, the phone uses its own configuration to send voice data packets.

11.5 VLAN unaware mode

The *VLAN-unaware mode* defines the operation of the device in a LAN segmented by VLANs. The device accepts packets and processes them according to its inbound rules. According to IEEE 802.1Q, the function governs how the device processes VLAN tagged packets.

Use the VLAN aware mode to apply the user-defined VLAN topology set up by the network administrator. When the device forwards packets, it uses VLAN tagging and the IP or Ethernet address. The device processes inbound and outbound packets according to the defined rules. VLAN configuration is a manual process.

Use the VLAN unaware mode to forward the data packets as received, without any modification. When the device receives packets as tagged, it transmits tagged packets. When the device receives packets as untagged, it transmits untagged packets. Regardless of VLAN assignment mechanisms, the device assigns packets to VLAN 1 and to a Multicast group, indicating that the packet flood domain is according to the VLAN.

12 Redundancy

12.1 Network Topology vs. Redundancy Protocols

When using Ethernet, a significant prerequisite is that data packets follow a single (unique) path from the sender to the receiver. The following network topologies support this prerequisite:

- ▶ Line topology
- ▶ Star topology
- ▶ Tree topology

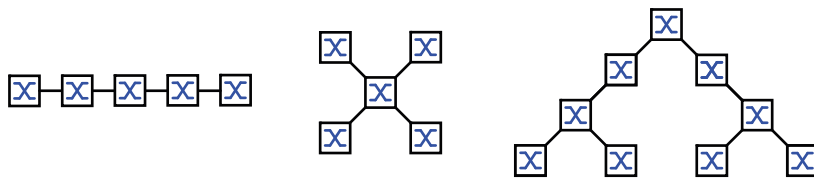

Figure 27: Network with line, star and tree topologies

To maintain communication in case a connection failure is detected, install additional physical connections between the network nodes. Redundancy protocols help ensure that the additional connections remain switched off while the original connection is still working. When a connection failure is detected, the redundancy protocol generates a new path from the sender to the receiver through the alternative connection.

To introduce redundancy onto Layer 2 of a network, you first define which network topology you require. Depending on the network topology selected, you then choose from the redundancy protocols that can be used with this network topology.

12.1.1 Network topologies

Meshed topology

For networks with star or tree topologies, redundancy procedures are only possible in connection with physical looping. The result is a meshed topology.

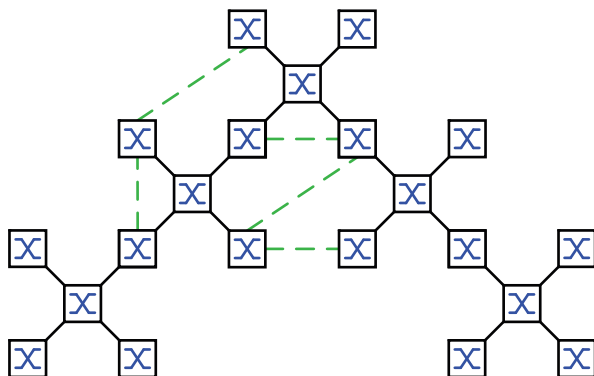

Figure 28: Meshed topology: Tree topology with physical loops

For operating in this network topology, the device provides you with the following redundancy protocols:

- ▶ Rapid Spanning Tree Protocol (RSTP)

Ring topology

In networks with a line topology, you can use redundancy procedures by connecting the ends of the line. This results in a ring topology.

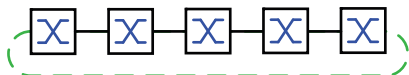

Figure 29: Ring topology: Line topology with connected ends

For operating in this network topology, the device provides you with the following redundancy protocols:

- ▶ Media Redundancy Protocol (MRP)
- ▶ Rapid Spanning Tree Protocol (RSTP)

12.1.2 Redundancy Protocols

For operating in different network topologies, the device provides you with the following redundancy protocols:

Table 28: Overview of redundancy protocols

Redundancy protocol	Network topology	Comments
MRP	Ring	The switching time can be selected and is practically independent of the number of devices. An MRP Ring consists of up to 50 devices that support the Media Redundancy Protocol (MRP) according to IEC 62439. When you only use Hirschmann devices, up to 100 devices are possible in the MRP Ring.
RSTP	Random structure	The switching time depends on the network topology and the number of devices. ▶ typ. < 1 s with RSTP ▶ typ. < 30 s with STP
Link Aggregation	Random structure	A Link Aggregation Group (LAG) is a combination of 2 or more links between 2 switches to increase bandwidth. Each involved link operates in full-duplex mode and with the same data rate.
Link Backup	Random structure	When the device detects an error on the primary link, the device transfers the data packets to the backup link. You typically use Link Backup in service-provider or enterprise networks.

Note: If you are using a redundancy function, then you deactivate the flow control on the participating device ports. If the flow control and the redundancy function are active at the same time, it is possible that the redundancy function operates differently than intended.

12.1.3 Combinations of redundancy protocols

Table 29: Overview of redundancy protocol combinations

	MRP	RSTP	Link Aggreg.	Link Backup
MRP	▲	—	—	—
RSTP	▲ ¹⁾	▲	—	—
Link Aggreg.	—	▲ ²⁾	▲	—
Link Backup	▲	▲	▲	▲

▲ Combination applicable

○ Combination not applicable

1) A redundant coupling between these network topologies will possibly lead to loops.

2) Combination applicable on the same port

12.2 Media Redundancy Protocol (MRP)

Since May 2008, the Media Redundancy Protocol (MRP) has been a standardized solution for ring redundancy in the industrial environment.

MRP is compatible with redundant ring coupling, supports VLANs, and is distinguished by very short reconfiguration times.

An MRP Ring consists of up to 50 devices that support the Media Redundancy Protocol (MRP) according to IEC 62439. When you only use Hirschmann devices, up to 100 devices are possible in the MRP Ring.

When you use the fixed MRP redundant port (Fixed Backup) and the *Ring Manager* device detects a primary ring link failure, it forwards data to the secondary ring link. When the primary link is restored, the secondary link continues to be in use.

12.2.1 Network structure

The concept of ring redundancy lets you construct high-availability ring-shaped network structures.

Using the *Ring manager* function, the two ends of a backbone in a line structure can be closed to a redundant ring. The *Ring Manager* device keeps the redundant line open as long as the line structure is intact. When a segment becomes inoperable, the *Ring Manager* device immediately closes the redundant line, and line structure is intact again.

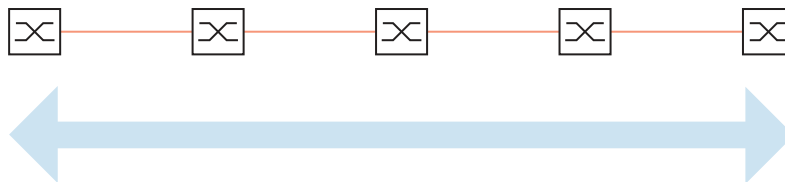

Figure 30: Line structure

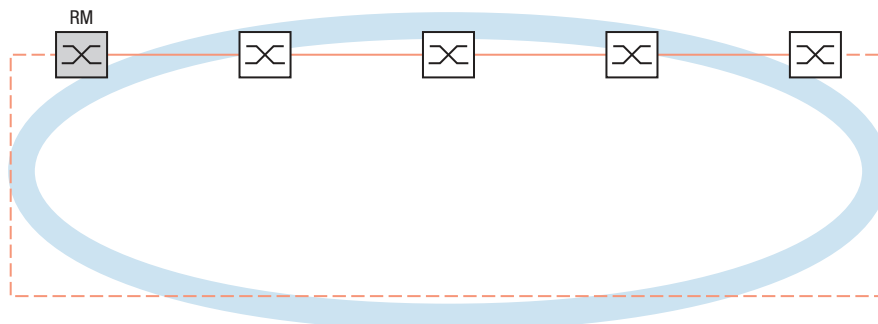

Figure 31: Redundant ring structure
RM = Ring Manager
— main line
- - - redundant line

12.2.2 Reconfiguration time

When a line section failure is detected, the *Ring Manager* device changes the MRP Ring back into a line structure. You define the maximum time for the reconfiguration of the line in the *Ring Manager* device.

Possible values for the maximum delay time:

- [500ms](#)
- [30ms](#)

Note: If every device in the ring supports the shorter delay time, then you can set up the reconfiguration time with a value less than [500ms](#).

Otherwise the devices that only support longer delay times might not be reachable due to overloading. Loops can occur as a result.

12.2.3 Advanced mode

For times even shorter than the specified reconfiguration time, the device provides the *Advanced mode*. When the ring participants inform the *Ring Manager* device about interruptions in the ring through *Link Down* notifications, the *Advanced mode* speeds up the link failure detection.

Hirschmann devices support *Link Down* notifications. Therefore, you generally activate the *Advanced mode* in the *Ring Manager* device.

When you are using devices that do not support *Link Down* notifications, the *Ring Manager* device reconfigures the line in the selected maximum reconfiguration time.

12.2.4 Prerequisites for MRP

Before setting up an MRP Ring, verify that the following conditions are fulfilled:

- ▶ All ring participants support MRP.
- ▶ The ring participants are connected to each other through the ring ports. Apart from its neighbors, no other ring participants are connected to the respective device.
- ▶ All ring participants support the configuration time specified in the *Ring Manager* device.
- ▶ There is exactly one *Ring Manager* device in the ring.

If you are using VLANs, then set up every ring port with the following settings:

- Deactivate ingress filtering - see the [Switching > VLAN > Port](#) dialog.
- Define the port VLAN ID (PVID) - see the [Switching > VLAN > Port](#) dialog.
 - PVID = 1 in cases where the device transmits the MRP data packets untagged (VLAN ID = 0 in [Switching > L2-Redundancy > MRP](#) dialog)

By setting the PVID = 1, the device automatically assigns the received untagged packets to VLAN 1.
 - PVID = any in cases where the device transmits the MRP data packets in a VLAN (VLAN ID ≥1 in the [Switching > L2-Redundancy > MRP](#) dialog)
- Define egress rules - see [Switching > VLAN > Configuration](#) dialog.
 - U (untagged) for the ring ports of VLAN 1 in cases where the device transmits the MRP data packets untagged (VLAN ID = 0 in the [Switching > L2-Redundancy > MRP](#) dialog, the MRP Ring is not assigned to a VLAN).
 - T (tagged) for the ring ports of the VLAN which you assign to the MRP Ring. Select T, in cases where the device transmits the MRP data packets in a VLAN (VLAN ID ≥1 in the [Switching > L2-Redundancy > MRP](#) dialog).

12.2.5 Advanced Information

MRP Packets

The Media Redundancy Protocol (MRP) uses *Test*, *Link Change*, and *Topology Change (FDB Flush)* packets.

The *Ring Manager* device is connected to the ring with 2 ring ports. As long as all connections in the ring are operational, the *Ring Manager* device sets one of its ports, the redundant port, into the *blocking* state. In this state, the redundant port neither receives nor sends normal (payload) data packets. This way, the *Ring Manager* device prevents a network loop.

The *Ring Manager* device periodically sends test packets into the ring from both ring ports. The test packets are special packets. The *Ring Manager* device sends and receives test packets even at the redundant port although the redundant port blocks normal packets. The *Ring Manager* device expects to receive the test packets on its respective other ring port. If the *Ring Manager* device does not receive any expected test packets for a specified amount of time, it detects a ring failure.

If the *Advanced mode* function is active, the *Ring Manager* device also reacts to *Link Down* packets. The prerequisite is that each device in the ring can send a *Link Change* packet when the link to the next device in the ring changes. These packets help the *Ring Manager* device react more quickly to a link failure or recovery. The *Ring Manager* device receives the *Link Change* packets even on its redundant port.

On reconfiguration of the ring, the *Ring Manager* device flushes its MAC address table (forwarding database) and sends *Topology Change* packets to the devices participating in the ring. The *Topology Change* packets prompt the other devices participating in the ring to flush their MAC address table (forwarding database), too. This procedure helps forward the payload packets over the new path more quickly. This procedure applies regardless of whether the ring reconfiguration was caused by a *Link Down* or a *Link Up* notification.

Table 30: MRP Packets

Packet Type	Send Mode	Time Parameter	Value
Test packet ¹	Periodically	Send interval	50 ms (for ring recovery time 500 ms) 20 ms (for ring recovery time 200 ms)
		Reception timeout	400 ms (for ring recovery time 500 ms) 160 ms (for ring recovery time 200 ms)
<i>Link Down</i> packet ²	Event-driven	On link-down of a ring port	-
<i>Topology Change</i> packet ³	Event-driven	On reconfiguration	-

1. Sent by the *Ring Manager* device only.

2. Sent by supporting ring participants.

3. The reception of a *Topology Change* packet prompts the supporting devices participating in the ring to flush their MAC address table (forwarding database).

MRP Packet Prioritization

The devices participating in the ring send *Test*, *Link Change*, and *Topology Change* packets with a user-configurable VLAN ID. The default VLAN ID is 0. The devices send the test packets untagged and thus without priority (Class of Service) information.

To help minimize the reconfiguration time under high network load, you can add a VLAN tag and thus priority information to these packets. The devices then forward and send these packets with the IEEE 802.1Q Class of Service priority 7 (Network control).

To prioritize the test packets, perform the following steps on the *Ring Manager* and *Ring Client* devices:

- Specify the MRP VLAN ID to a value ≥ 1 .
- Specify the ring ports as T (tagged) members of this MRP VLAN.

Note: When you set the MRP VLAN ID to a value ≥ 1 in the *Switching > L2-Redundancy > MRP* dialog, the device adds its ring ports as T (tagged) members of this MRP VLAN. If the MRP VLAN does not yet exist, the device automatically sets up this VLAN. After setting a new MRP VLAN ID, check the *Switching > VLAN > Configuration* dialog for the VLAN and the port settings.

12.2.6 Application example of an MRP Ring

A backbone network contains 3 devices in a line structure. To increase the availability of the network, you convert the line structure to a redundant ring structure. Devices from different manufacturers are used. All devices support MRP. On every device you define ports *1/1* and *1/2* as ring ports.

When a primary ring link failure is detected, the *Ring Manager* device sends data on the secondary ring link. When the primary link is restored, the secondary link reverts back to the backup mode.

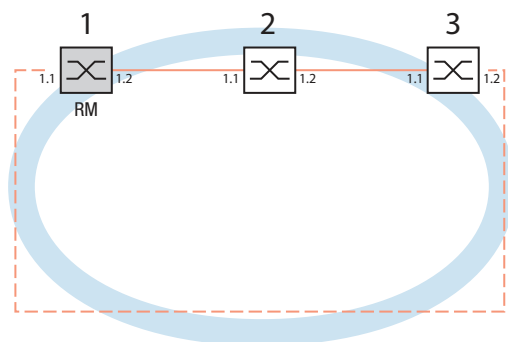

Figure 32: Example of MRP Ring
RM = Ring Manager
— main line
- - - redundant line

The following example configuration describes the configuration of the *Ring Manager* device (1). You set up the 2 other devices (2 to 3) in the same way, but without enabling the *Ring manager* function. This example does not use a VLAN. You specify the value *30ms* as the ring recovery time. Every device supports the *Advanced mode* function.

- Set up the network to meet your demands.
- To minimize the ring recovery time in case of a link-up after a failure, set up the speed and duplex mode of the ring ports as follows:
 - For 100 Mbit/s TX ports, disable Automatic Negotiation and manually set up *100M FDX*.
 - For the other port types, keep the port-specific default settings.

Note: Set up each device of the MRP Ring individually. Before you connect the redundant line, verify that you have completed the configuration of every device of the MRP Ring. You thus help avoid loops during the configuration phase.

You deactivate the flow control on the participating ports.

If the flow control and the redundancy function are active at the same time, it is possible that the redundancy function operates differently than intended. (Default setting: flow control deactivated globally and activated on every port.)

Disable the *Spanning Tree* function in every device in the network. To do this, perform the following steps:

- Open the *Switching > L2-Redundancy > Spanning Tree > Global* dialog.
- Disable the function.
In the state on delivery, Spanning Tree is enabled in the device.

enable	To change to the Privileged EXEC mode.
configure	To change to the Configuration mode.
no spanning-tree operation	To switch Spanning Tree off.
show spanning-tree global	To display the parameters for checking.

Enable MRP on every device in the network. To do this, perform the following steps:

- Open the *Switching > L2-Redundancy > MRP* dialog.
- Specify the desired ring ports.

In the Command Line Interface you first define an additional parameter, the MRP domain ID. Set up every ring participant with the same MRP domain ID. The MRP domain ID is a sequence of 16 number blocks (8-bit values).

When configuring with the Graphical User Interface, the device uses the default value `255 255 255 255 255 255 255 255 255 255 255 255 255 255`.

<code>mrp domain add default-domain</code>	To add an MRP domain with the ID <code>default-domain</code> .
<code>mrp domain modify port primary 1/1</code>	To specify port <code>1/1</code> as ring port 1.
<code>mrp domain modify port secondary 1/2</code>	To specify port <code>1/2</code> as ring port 2.

Enable the *Fixed backup* port. To do this, perform the following steps:

- Enable the *Ring manager* function.
For the other devices in the ring, leave the setting as *Off*.
- To allow the device to continue sending data on the secondary port after the ring is restored, mark the *Fixed backup* checkbox.

Note: When the device reverts back to the *Primary port*, the maximum ring recovery time can be exceeded.

When you unmark the *Fixed backup* checkbox, and the ring is restored, the *Ring Manager* device blocks the secondary port and unblocks the *Primary port*.

mrp domain modify port secondary 1/2 fixed-backup enable

To activate the *Fixed backup* function on the secondary port. The secondary port continues forwarding data after the ring is restored.

- Enable the *Ring manager* function.
For the other devices in the ring, leave the setting as *Off*.

mrp domain modify mode manager

To designate the device as the *Ring Manager* device. For the other devices in the ring, leave the default setting.

- Select the checkbox in the *Advanced mode* field.

mrp domain modify advanced-mode enabled

To activate the *Advanced mode*.

- In the *Ring recovery* field, select the value *30ms*.

mrp domain modify recovery-delay 200ms

To specify the value *30ms* as the max. delay time for the reconfiguration of the ring.

Note: If selecting the value *30ms* for the ring recovery does not provide the ring stability necessary to meet the requirements of the network, then select the value *500ms*.

- Switch the operation of the MRP Ring on.
- Apply the settings temporarily. To do this, click the button.

mrp domain modify operation enable

To activate the MRP Ring.

When every ring participant is set up, close the line to create the ring. To do this, you connect the devices at the ends of the line through their ring ports.

Check the messages from the device. To do this, perform the following steps:

`show mrp` To display the parameters for checking.

The *Operation* field displays the operating state of the ring port.

Possible values:

- ▶ *forwarding*
The port is enabled, connection exists.
- ▶ *blocked*
The port is blocked, connection exists.
- ▶ *disabled*
The port is disabled.
- ▶ *not-connected*
No connection exists.

The *Information* field displays messages for the redundancy configuration and the possible causes of detected errors.

When the device operates in the *Ring Client* or *Ring Manager* mode, the following messages are possible:

- ▶ *Redundancy available*
The redundancy is set up. When a component of the ring is inoperable, the redundant line takes over its function.
- ▶ *Configuration error: Error on ringport link.*
An error is detected in the cabling of the ring ports.

When the device operates in the *Ring Manager* mode, the following messages are possible:

- ▶ *Configuration error: Packets from another ring manager received.*
Another device exists in the ring that operates in the *Ring Manager* mode. Enable the *Ring manager* function on exactly one device in the ring.
- ▶ *Configuration error: Ring link is connected to wrong port.*
A line in the ring is connected with a different port instead of with a ring port. The device only receives test data packets on one ring port.

When applicable, integrate the MRP Ring into a VLAN. To do this, perform the following steps:

- In the *VLAN ID* field, define the MRP VLAN ID. The MRP VLAN ID determines in which of the set-up VLANs the device transmits the MRP packets. To set the MRP VLAN ID, first set up the VLANs and the corresponding egress rules in the *Switching > VLAN > Configuration* dialog.
 - If the MRP Ring is not assigned to a VLAN (like in this example), then leave the VLAN ID as `0`.
In the *Switching > VLAN > Configuration* dialog, specify the VLAN membership as `U` (untagged) for the ring ports in VLAN `1`.
 - If the MRP Ring is assigned to a VLAN, then enter a VLAN ID `>0`.
In the *Switching > VLAN > Configuration* dialog, specify the VLAN membership as `T` (tagged) for the ring ports in the selected VLAN.

`mrp domain modify vlan <0..4042>` To assign the VLAN ID.

12.3 Spanning Tree

Note: The Spanning Tree Protocol (STP) is a protocol for MAC bridges. For this reason, the following description uses the term bridge for the device.

Local networks are getting bigger and bigger. This applies to both the geographical expansion and the number of network participants. Therefore, it is advantageous to use multiple bridges, for example:

- ▶ to reduce the network load in sub-areas,
- ▶ to set up redundant connections and
- ▶ to overcome distance limitations.

However, using multiple bridges with multiple redundant connections between the subnets can lead to loops and thus interruption of communication across the network. To help avoid this, you can use Spanning Tree. Spanning Tree helps avoid loops through the systematic deactivation of redundant connections. Redundancy enables the systematic reactivation of individual connections as needed.

RSTP is a further development of the Spanning Tree Protocol (STP) and is compatible with it. When a connection or a bridge becomes inoperable, the STP requires a maximum of 30 seconds to reconfigure. This is no longer acceptable in time-sensitive applications. RSTP achieves average reconfiguration times of less than a second. When you use RSTP in a ring topology with 10 to 20 devices, you can even achieve reconfiguration times in the order of milliseconds.

Note: RSTP reduces a layer 2 network topology with redundant paths into a tree structure (Spanning Tree) that does not contain any more redundant paths. One of the devices takes over the role of the *Root bridge* here. The maximum number of devices permitted in an active branch from the *Root bridge* to the tip of the branch is specified by the variable *Max age* for the current *Root bridge*. The preset value for *Max age* is 20, which can be increased up to 40.

If the device working as the root is inoperable and another device takes over its function, then the *Max age* setting of the new *Root bridge* determines the maximum number of devices allowed in a branch.

Note: The RSTP standard requires that every device within a network operates with the (Rapid) Spanning Tree Algorithm. When STP and RSTP are used at the same time, the advantages of faster reconfiguration with RSTP are lost in the network segments that are operated in combination.

A device that only supports RSTP works together with MSTP devices by not assigning an MST region to itself, but rather the Common Spanning Tree (CST).

12.3.1 Basics

Because RSTP is a further development of the STP, every of the following descriptions of the STP also apply to RSTP.

The tasks of the STP

The Spanning Tree Algorithm reduces network topologies built with bridges and containing ring structures due to redundant links to a tree structure. In doing so, STP opens ring structures according to preset rules by deactivating redundant paths. When a path is interrupted because a network component becomes inoperable, STP reactivates the previously deactivated path again. This lets redundant links increase the availability of communication.

STP determines a bridge that represents the STP tree structure's base. This bridge is called *Root bridge*.

Features of the STP algorithm:

- ▶ Automatic reconfiguration of the tree structure in the case of a bridge becoming inoperable or the interruption of a data path.
- ▶ The tree structure is stabilized up to the maximum network size.
- ▶ The topology stabilizes within a predictable time period.
- ▶ The administrator can specify and reproduce the topology.
- ▶ Transparency for the end devices.
- ▶ The network load is low relative to the available transmission capacity due to the tree structure set-up.

Bridge parameters

In the context of Spanning Tree, each bridge and its connections are uniquely described by the following parameters:

- ▶ *Bridge Identifier*
- ▶ *Root path cost* of the bridge ports
- ▶ *Port Identifier*

Bridge Identifier

The *Bridge Identifier* consists of 8 bytes. The bridge with the numerically lowest *Bridge Identifier* value has the highest priority.

According to the original standard IEEE 802.1D-1998, the 2 highest-value bytes are the *Bridge priority*. When configuring the bridge, the bridge administrator can change the default setting for the *Bridge priority* which is 32768 (8000H).

In the newer standard IEEE 802.1Q-2014, the *Bridge priority* is interpreted differently. The highest 4 bits represent the *Bridge priority*. The lower 12 bits are reserved for the VLAN ID and are all zero. As a result, the bridge administrator can set the *Bridge priority* in steps of 4096. The default value is 32768 (8000H), and the max. value is 61440 (F000H).

The 6 lowest-value bytes of the *Bridge Identifier* are the MAC address of the bridge. The MAC address lets each bridge have a unique *Bridge Identifier*.

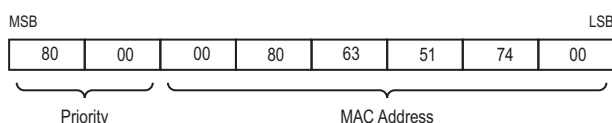

Figure 33: *Bridge Identifier, Example (interpretation according to IEEE 802.1D-1998, values in hexadecimal notation)*

Root path cost

Each path that connects 2 bridges is assigned a cost for the transmission (path cost). The device determines this value based on the transmission speed (see table 31 on page 199). The device assigns a higher path cost to paths with lower transmission speeds.

As an alternative, the administrator can set the path cost. Like the device, the administrator assigns a higher path cost to paths with lower transmission speeds. However, since the administrator can choose this value freely, he has a tool with which he can give a certain path an advantage among redundant paths.

The *Root path cost* is the sum of the individual path costs from the port of the connected bridge to the *Root bridge*.

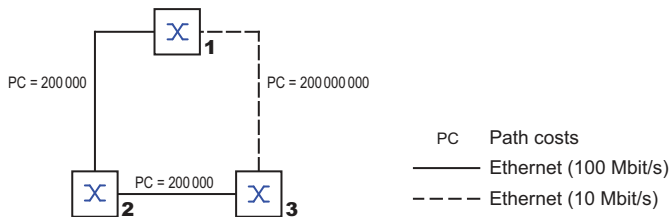

Figure 34: Path costs

Table 31: Recommended path costs for RSTP based on the data rate.

Data rate	Recommended value	Recommended range	Possible range
≤100 kbit/s	200 000 000 ¹	20 000 000-200 000 000	1-200 000 000
1 Mbit/s	20 000 000 ^a	2 000 000-200 000 000	1-200 000 000
10 Mbit/s	2 000 000 ^a	200 000-20 000 000	1-200 000 000
100 Mbit/s	200 000 ^a	20 000-2 000 000	1-200 000 000
1 Gbit/s	20 000	2 000-200 000	1-200 000 000
10 Gbit/s	2 000	200-20 000	1-200 000 000
100 Gbit/s	200	20-2 000	1-200 000 000
1 Tbit/s	20	2-200	1-200 000 000
10 Tbit/s	2	1-20	1-200 000 000

1. Verify that bridges, which conform to IEEE 802.1D-1998 and only support 16-bit values for the path costs, use the value 65535 (FFFFH) for path costs in cases where they are used in conjunction with bridges that support 32-bit values for the path costs.

Port Identifier

According to the original standard IEEE 802.1D-1998, the *Port Identifier* consists of 2 bytes. The lower-value byte contains the physical port number. This provides a unique identifier for the port of this bridge. The higher-value byte is the *Port priority*, which is specified by the administrator (default value: 128 or 80H).

In the newer standard IEEE 802.1Q-2014, the *Port priority* is interpreted differently. The highest 4 bits represent the *Port priority*. The lower 12 bits are the port number. This allows for bridges with up to 4095 ports. As a result, the bridge administrator can set the *Port priority* in steps of 4096, when viewed as a 16-bit number. The default value is 32768 (8000H), and the max. value is 61440 (F000H). When viewed as 4-bit number, the default value is 8 (8H), the min. value is 0 (0H), and the max. value is 15 (FH).

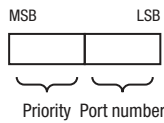

Figure 35: *Port Identifier (interpretation according to IEEE 802.1D-1998)*

Max Age and Diameter

The “Max Age” and “Diameter” values largely determine the maximum expansion of a Spanning Tree network.

Diameter

The number of connections between the devices in the network that are furthest removed from each other is known as the network diameter.

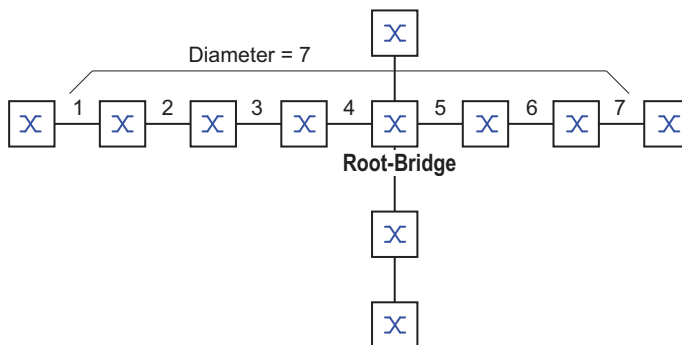

Figure 36: *Definition of diameter*

The network diameter that can be achieved in the network is MaxAge-1.

In the state on delivery, MaxAge = 20 and the maximum diameter that can be achieved is 19. When you set the maximum value of 40 for MaxAge, the maximum diameter that can be achieved is 39.

MaxAge

Every STP-BPDU contains a “MessageAge” counter. When a bridge is passed through, the counter increases by 1.

Before forwarding a STP-BPDU, the bridge compares the “MessageAge” counter with the “MaxAge” value specified in the device:

- When MessageAge < MaxAge, the bridge forwards the STP-BPDU to the next bridge.
- When MessageAge = MaxAge, the bridge discards the STP-BPDU.

Root-Bridge

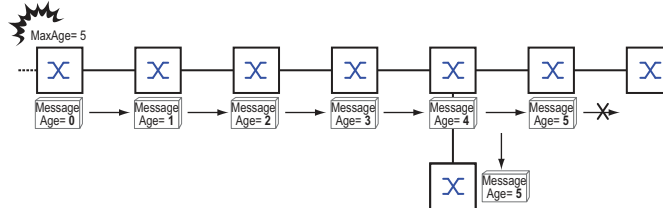

Figure 37: Transmission of an STP-BPDU depending on MaxAge

12.3.2 Rules for Creating the Tree Structure

Bridge information

To determine the tree structure, the bridges need more detailed information about the other bridges located in the network.

To obtain this information, each bridge sends a BPDU (Bridge Protocol Data Unit) to the other bridges.

The contents of a BPDU include:

- ▶ *Bridge Identifier*
- ▶ *Root path cost*
- ▶ *Port Identifier*

(see IEEE 802.1D)

Setting up the tree structure

The bridge with the numerically lowest *Bridge Identifier* value is called the *Root bridge*. This bridge is (or will become) the root of the tree structure.

The structure of the tree depends on the *Root path costs*. Spanning Tree selects the structure so that the path costs between each individual bridge and the *Root bridge* become as small as possible.

- ▶ When there are multiple paths with the same *Root path costs*, the bridge further away from the root decides which port it blocks. For this purpose, the bridge further from the root uses the *Bridge Identifiers* of the bridge closer to the root. The the bridge further from the root blocks the port that leads to the bridge with the numerically higher ID (a numerically higher ID is the logically worse one). When 2 bridges have the same priority, the bridge with the numerically larger MAC address has the numerically higher ID, which is logically the worse one.
- ▶ When multiple paths with the same *Root path costs* lead from one bridge to the same bridge, the bridge further away from the root uses the *Port Identifier* of the other bridge as the last criterion (see figure 35 on page 200). In the process, the bridge blocks the port that leads to the port with the numerically higher ID. A numerically higher ID is the logically worse one. When 2 ports have the same priority, the port with the higher port number has the numerically higher ID, which is logically the worse one.

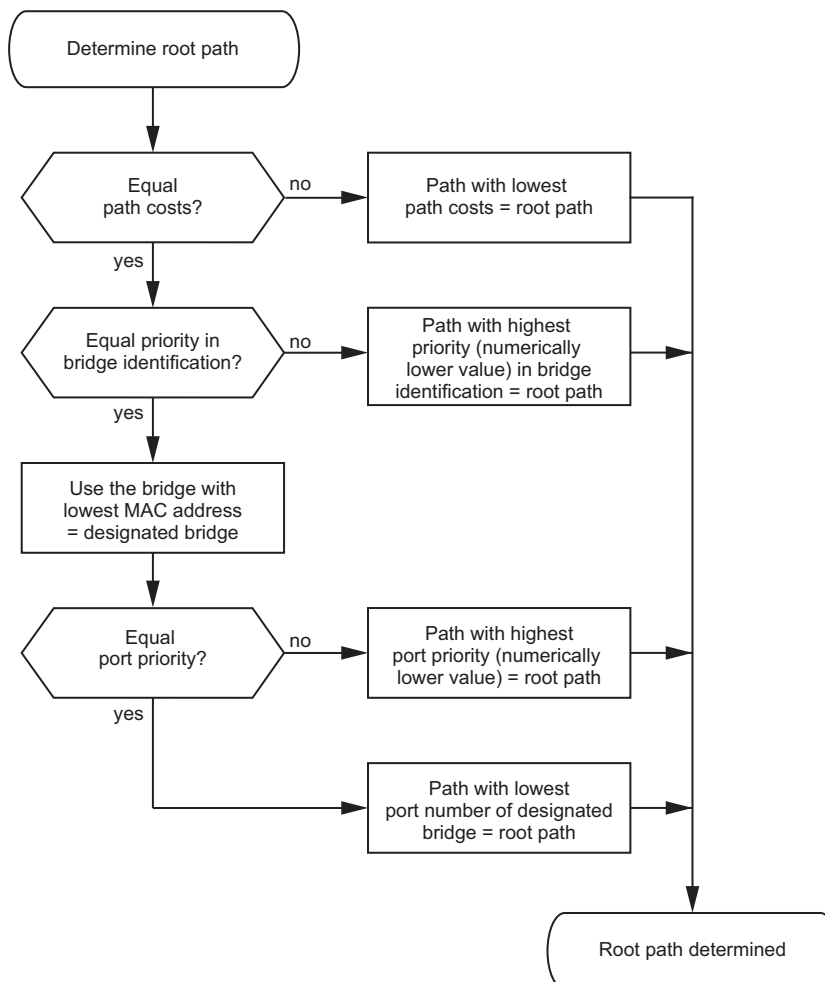

Figure 38: Flow diagram for specifying the root path

12.3.3 Examples

Example of determining the root path

You can use the network plan to follow the flow chart (see figure 38 on page 202) for determining the root path. The administrator has specified a priority in the *Bridge Identifier* for each bridge. The bridge with the numerically lowest value for the *Bridge Identifier* takes on the role of the *Root bridge*, in this case, bridge 1. In the example every sub-path has the same path costs. The protocol blocks the path between bridge 2 and bridge 3 because a connection from bridge 3 through bridge 2 to the *Root bridge* would result in higher path costs.

The path from bridge 6 to the *Root bridge* is interesting:

- ▶ The path through bridge 5 and bridge 3 has the same *Root path costs* as the path through bridge 4 and bridge 2.
- ▶ STP selects the path using the bridge that has the lowest MAC address in the *Bridge Identifier* (bridge 4 in the illustration).
- ▶ There are also 2 paths between bridge 6 and bridge 4. The *Port Identifier* is decisive here (Port 1 < Port 3).

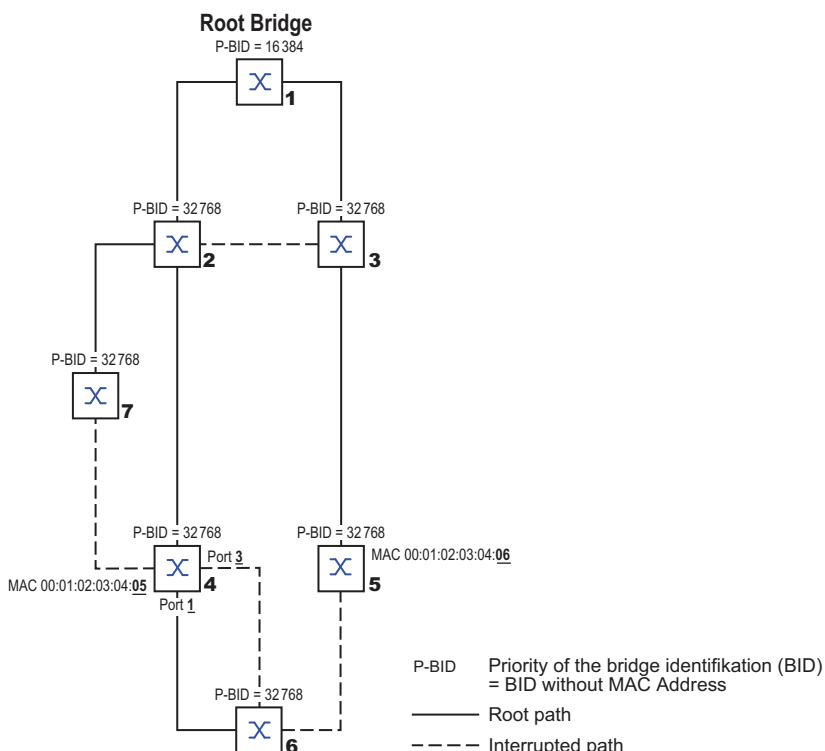

Figure 39: Example of a network plan for determining the root path

Note: When the current *Root bridge* goes down, the MAC address in the *Bridge Identifier* alone determines which bridge becomes the new *Root bridge*, because the administrator does not change the default values for the priorities of the bridges in the *Bridge Identifier*, apart from the value for the *Root bridge*.

Example of manipulating the root path

You can use the network plan to follow the flow chart (see figure 38 on page 202) for determining the root path. The administrator has performed the following:

- Left the default value of 32768 (8000H) for every bridge apart from bridge 1 and bridge 5, and
- assigned to bridge 1 the value 16384 (4000H), thus making it the *Root bridge*.
- To bridge 5 he assigned the value 28672 (7000H).

The protocol blocks the path between bridge 2 and bridge 3 because a connection from bridge 3 through bridge 2 to the *Root bridge* would result in higher path costs.

The path from bridge 6 to the *Root bridge* is interesting:

- ▶ The bridges select the path through bridge 5 because the value 28672 for the priority in the *Bridge Identifier* is lower than the value 32768.

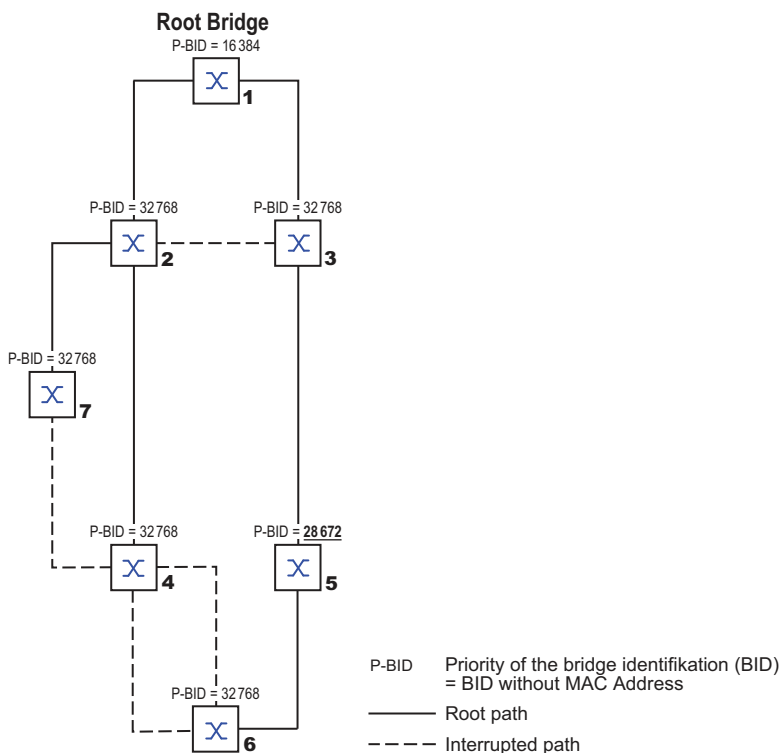
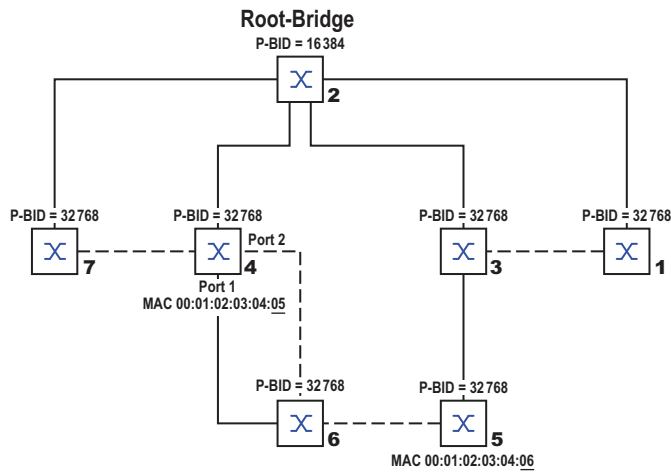

Figure 40: Example of a network plan for manipulating the root path

Example of manipulating the tree structure

The administrator soon discovers that this configuration with bridge 1 as the *Root bridge* is invalid. On the paths from bridge 1 to bridge 2 and bridge 1 to bridge 3, the control packets which the *Root bridge* sends to every other bridge add up.

When the administrator sets up bridge 2 as the *Root bridge*, the burden of the control packets on the subnets is distributed much more evenly. The result is the configuration shown in the following figure. The path costs for most of the bridges to the *Root bridge* have decreased.



P-BID Priority of the bridge identification (BID)
= BID without MAC Address

—— Root path

----- Interrupted path

Figure 41: Example of manipulating the tree structure

12.4 Rapid Spanning Tree Protocol

The Rapid Spanning Tree Protocol (RSTP) uses the same algorithm for determining the tree structure as Spanning Tree Protocol (STP). When a link or bridge becomes inoperable, the Rapid Spanning Tree Protocol (RSTP) adds mechanisms that speed up the reconfiguration.

The ports play a significant role in this context.

12.4.1 Port roles

The Rapid Spanning Tree Protocol (RSTP) assigns each bridge port one of the following roles:

- ▶ **Root port:**
This is the port at which a bridge receives data packets with the lowest path costs from the *Root bridge*.
When there are multiple ports with equally low path costs, the *Bridge Identifier* of the bridge that leads to the root (*Designated bridge*) decides which of its ports is given the role of the *Root port* by the bridge further away from the root.
When a bridge has multiple ports with equally low path costs to the same bridge, the bridge uses the port ID of the bridge leading to the root (*Designated bridge*) to decide which port it selects locally as the *Root port*. See [figure 38 on page 202](#).
The *Root bridge* itself does not have a *Root port*, only *Designated ports*.
- ▶ **Designated port:**
The bridge in a network segment that has the numerically lowest *Root path costs* value is the *Designated bridge*.
When more than one bridge has the same *Root path costs*, the bridge with the numerically lowest *Bridge Identifier* value becomes the *Designated bridge*. The *Designated port* on this bridge is the port that connects a network segment leading away from the *Root bridge*. When a bridge is connected to a network segment through more than one port (through a hub, for example), the bridge gives the role of the *Designated port* to the port with the better port ID.
- ▶ **Edge port**
Every network segment with no additional RSTP bridges is connected with exactly one *Designated port*. In this case, this *Designated port* is also an *Edge port*. The distinction of an *Edge port* is the fact that it does not receive any *RST BPDUs (Rapid Spanning Tree Bridge Protocol Data Units)*.
- ▶ **Alternate port**
When the connection to the *Root bridge* is lost, this blocked port takes over the task of the *Root port*. The *Alternate port* provides a backup for the connection to the *Root bridge*.

- ▶ **Backup port**
This is a blocked port that serves as a backup in case the connection to the *Designated port* of this network segment (without any RSTP bridges) is lost
- ▶ **Disabled port**
This is a port that does not participate in the Spanning Tree Operation, that means, the port is switched off or does not have any connection.

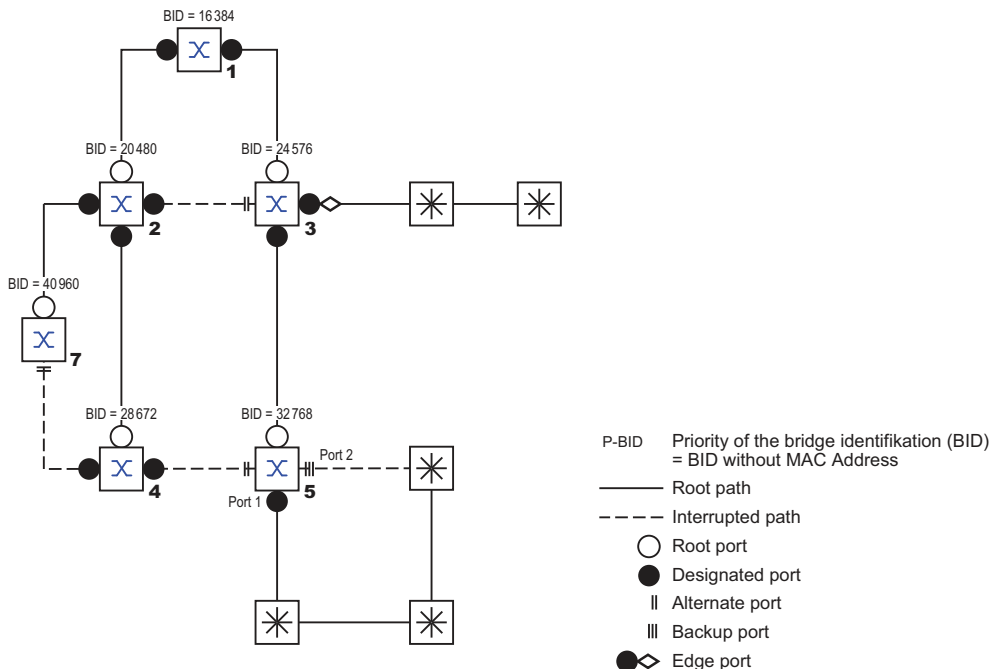

Figure 42: Port role assignment

12.4.2 Port states

Depending on the tree structure and the state of the selected connection paths, RSTP assigns the ports their states.

Table 32: Relationship between port state values for STP and RSTP

STP port state	Administrative bridge port state	MAC Operational	RSTP Port state	Active topology (port role)
<i>Disabled</i>	Disabled	FALSE	<i>Discarding</i> ¹	Excluded (disabled)
<i>Disabled</i>	Enabled	FALSE	<i>Discarding</i> ^a	Excluded (disabled)
<i>Blocking</i>	Enabled	TRUE	<i>Discarding</i> ²	Excluded (alternate, backup)
<i>Listening</i>	Enabled	TRUE	<i>Discarding</i> ^b	Included (root, designated)
<i>Learning</i>	Enabled	TRUE	<i>Learning</i>	Included (root, designated)
<i>Forwarding</i>	Enabled	TRUE	<i>Forwarding</i>	Included (root, designated)

1. The dot1d-MIB displays *Disabled*.

2. The dot1d-MIB displays *Blocked*.

Meaning of the RSTP port states:

- ▶ **Disabled:** Port does not belong to the active topology
- ▶ **Discarding:** No address learning in the MAC address table (forwarding database), no data packets except for STP-BPDUs

- ▶ *Learning*: Address learning active in the MAC address table (forwarding database), no data packets apart from STP-BPDUs
- ▶ *Forwarding*: Address learning in the MAC address table (forwarding database) active, sending and receiving of every packet type (not only STP-BPDUs)

12.4.3 Spanning Tree Priority Vector

To assign roles to the ports, the RSTP bridges exchange configuration information with each other. This information is known as the Spanning Tree Priority Vector. It is part of the *RST BPDUs* and contains the following information:

- ▶ *Bridge Identifier of the Root bridge*
- ▶ *Root path costs of the sending bridge*
- ▶ *Bridge Identifier of the sending bridge*
- ▶ *Port Identifier of the port through which the message was sent*
- ▶ *Port Identifier of the port through which the message was received*

Based on this information, the bridges participating in RSTP are able to determine port roles themselves and define the port states of their own ports.

12.4.4 Fast reconfiguration

Why can RSTP react faster than STP to an interruption of the root path?

- ▶ Introduction of edge-ports:
During a reconfiguration, RSTP sets an *Edge port* into the transmission mode after 3 seconds (default setting). To ascertain that no bridge sending BPDUs is connected, RSTP waits for the "Hello Time" to elapse.
When you verify that an end device is and remains connected to this port, there are no waiting times at this port in the case of a reconfiguration.
- ▶ Introduction of *Alternate ports*:
As the port roles are already distributed in normal operation, a bridge can immediately switch from the *Root port* to the *Alternate port* after the connection to the *Root bridge* is lost.
- ▶ Communication with neighboring bridges (point-to-point connections):
Decentralized, direct communication between neighboring bridges enables reaction without wait periods to status changes in the spanning tree topology.
- ▶ Address table:
With Spanning Tree Protocol (STP), the age of the entries in the MAC address table (forwarding database) determines the updating of communication. The Rapid Spanning Tree Protocol (RSTP) immediately deletes the entries in those ports affected by a reconfiguration.
- ▶ Reaction to events:
Without having to match any time specifications, Rapid Spanning Tree Protocol (RSTP) immediately reacts to events, for example, connection interruption and connection reinstatement.

Note: Data packages could be duplicated and/or arrive at the recipient in the wrong order during the reconfiguration phase of the RSTP topology. You may also use the Spanning Tree Protocol (STP) or select another redundancy procedure described in this manual.

12.4.5 Configuring the device

RSTP sets up the network topology completely autonomously. The device with the numerically lowest *Bridge priority* value automatically becomes the *Root bridge*. However, to define a specific network structure, you specify a device as the *Root bridge*. In general, a device in the backbone takes on this role.

Perform the following steps:

- Set up the network to meet your requirements, initially without redundant lines.
- You deactivate the flow control on the participating ports.
If the flow control and the redundancy function are active at the same time, it is possible that the redundancy function operates differently than intended. (Default setting: flow control deactivated globally and activated on every port.)
- Disable MRP on every device.
- Enable Spanning Tree on every device in the network.
In the state on delivery, Spanning Tree is switched on in the device.

Perform the following steps:

- Open the *Switching > L2-Redundancy > Spanning Tree > Global* dialog.
- Enable the function.
- Apply the settings temporarily. To do this, click the  button.

enable	To change to the Privileged EXEC mode.
configure	To change to the Configuration mode.
spanning-tree operation	To enable Spanning Tree.
show spanning-tree global	To display the parameters for checking.

Now connect the redundant lines.

Define the settings for the device that takes over the role of the *Root bridge*.

Perform the following steps:

- In the *Priority* field you specify a numerically lower value.
The bridge with the numerically lowest *Bridge Identifier* value has the highest priority and becomes the *Root bridge* of the network.
- Apply the settings temporarily. To do this, click the  button.

spanning-tree mst priority 0 <0..61440>	To specify the <i>Bridge priority</i> of the device.
---	--

Note: Specify the *Bridge priority* in the range 0..61440 in steps of 4096.

After saving, the dialog shows the following information:

- The *Bridge is root* checkbox is marked.
- The *Root port* field shows the value 0.0.
- The *Root path cost* field shows the value 0.

`show spanning-tree global` To display the parameters for checking.

- If applicable, then change the values in the *Forward delay [s]* and *Max age* fields.
 - The *Root bridge* transmits the changed values to the other devices.
- Apply the settings temporarily. To do this, click the button.

`spanning-tree forward-time <4..30>` To specify the delay time for the status change in seconds.

`spanning-tree max-age <6..40>` To specify the maximum permissible branch length, for example the number of devices to the *Root bridge*.

`show spanning-tree global` To display the parameters for checking.

Note: The parameters *Forward delay [s]* and *Max age* have the following relationship:

$$\text{Forward delay [s]} \geq (\text{Max age}/2) + 1$$

If you enter values in the fields that contradict this relationship, then the device replaces these values with the last valid values or with the default value.

Note: When possible, do not change the value in the “Hello Time” field.

Check the following values in the other devices:

- *Bridge Identifier* (*Bridge priority* and MAC address) of the corresponding device and the *Root bridge*.
- Number of the device port that leads to the *Root bridge*.
- Path cost from the *Root port* of the device to the *Root bridge*.

Perform the following steps:

`show spanning-tree global` To display the parameters for checking.

12.4.6 Guards

The device lets you activate various protection functions (guards) in the device ports.

The following protection functions help protect the network from incorrect configurations, loops and attacks with STP-BPDUs:

- ▶ **BPDU guard** – for manually specified *Edge ports* (end device ports)
You activate this protection function globally in the device.

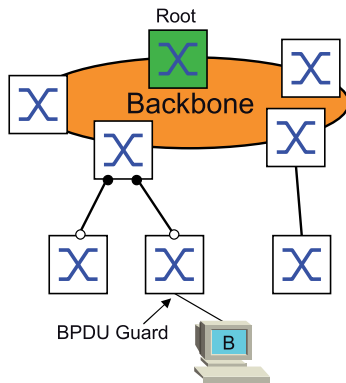

Terminal device ports do not normally receive any STP-BPDUs. If an attacker still attempts to feed in STP-BPDUs on this port, then the device deactivates the device port.

- ▶ **Root guard** – for *Designated ports*
You activate this protection function separately for every device port.

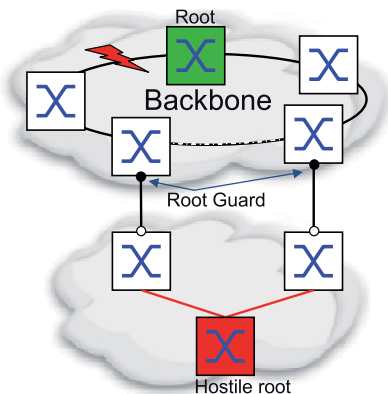

When a *Designated port* receives an STP-BPDU with better path information to the *Root bridge*, the device discards the STP-BPDU and sets the transmission state of the port to *discarding* instead of *root*.

When there are no STP-BPDUs with better path information to the *Root bridge*, after $2 \times \text{Hello time [s]}$ the device resets the state of the port to a value according to the port role.

- ▶ **TCN guard** – for ports that receive STP-BPDUs with a *Topology Change* flag
You activate this protection function separately for every device port.

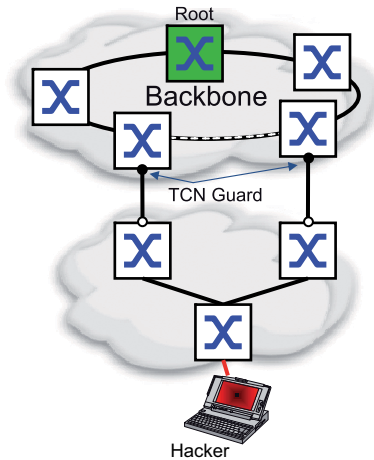

If the protection function is activated, then the device ignores *Topology Change* flags in received STP-BPDUs. This does not change the content of the MAC address table (forwarding database) of the device port. However, additional information in the BPDU that changes the topology is processed by the device.

- ▶ **Loop guard** – for *Root ports*, *Alternate ports* and *Backup ports*
You activate this protection function separately for every device port.

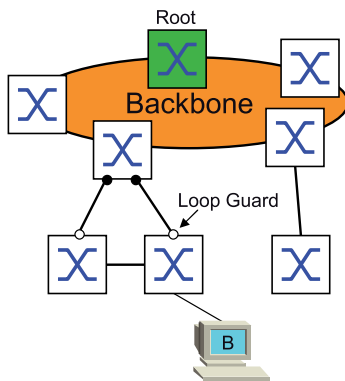

If the port does not receive any more STP-BPDUs, then this protection function helps prevent the transmission status of a port from unintentionally being changed to *forwarding*. If this situation occurs, then the device designates the loop status of the port as inconsistent, but does not forward any data packets.

Activating the BPDU guard function

Perform the following steps:

- Open the *Switching > L2-Redundancy > Spanning Tree > Global* dialog.
- Mark the *BPDU guard* checkbox.
- Apply the settings temporarily. To do this, click the ✓ button.

enable

To change to the Privileged EXEC mode.

<pre>configure spanning-tree bpdu-guard show spanning-tree global</pre>	<p>To change to the Configuration mode.</p> <p>To activate the <i>BPDU guard</i> function.</p> <p>To display the parameters for checking.</p>
---	---

- Open the *Switching > L2-Redundancy > Spanning Tree > Port* dialog.
- Switch to the *CIST* tab.
- For end device ports, mark the checkbox in the *Admin edge port* column.
- Apply the settings temporarily. To do this, click the button.

<pre>interface <x/y> spanning-tree edge-port show spanning-tree port x/y exit</pre>	<p>To change to the interface configuration mode of interface <i><x/y></i>.</p> <p>To designate the port as a <i>Edge port</i> (end device port).</p> <p>To display the parameters for checking.</p> <p>To leave the interface mode.</p>
---	--

When an *Edge port* receives an STP-BPDU, the device behaves as follows:

- ▶ The device deactivates this port.
In the *Basic Settings > Port* dialog, *Configuration* tab, the checkbox for this port in the *Port on* column is unmarked.
- ▶ The device designates the port.

You can determine if a port has disabled itself because of a received a BPDU. To do this, perform the following steps:

In the *Switching > L2-Redundancy > Spanning Tree > Port* dialog, *Guards* tab, the checkbox in the *BPDU guard effect* column is marked.

<pre>show spanning-tree port x/y</pre>	<p>To display the parameters of the port for checking. The value of the <i>BPDU guard effect</i> parameter is <i>enabled</i>.</p>
--	---

Reset the status of the device port to the value *forwarding*. To do this, perform the following steps:

- When the port still receives BPDUs:
 - Remove the manual definition as an *Edge port* (end device port).
or
 - Deactivate the *BPDU guard* function.
- Activate the device port again.

Activating the Root guard / TCN guard / Loop guard function

Perform the following steps:

- Open the *Switching > L2-Redundancy > Spanning Tree > Port* dialog.
- Switch to the *Guards* tab.
- For *Designated ports*, select the checkbox in the *Root guard* column.
- For ports that receive STP-BPDUs with a *Topology Change* flag, select the checkbox in the *TCN guard* column.
- For *Root ports*, *Alternate ports* or *Backup ports*, mark the checkbox in the *Loop guard* column.

Note: The *Root guard* and *Loop guard* functions are mutually exclusive. If you try to activate the *Root guard* function while the *Loop guard* function is active, then the device deactivates the *Loop guard* function.

- Apply the settings temporarily. To do this, click the button.

enable	To change to the Privileged EXEC mode.
configure	To change to the Configuration mode.
interface <x/y>	To change to the interface configuration mode of interface <x/y>.
spanning-tree guard-root	To activate the <i>Root guard</i> function on the <i>Designated port</i> .
spanning-tree guard-tcn	To activate the <i>TCN guard</i> function on the port that receives STP-BPDUs with a <i>Topology Change</i> flag.
spanning-tree guard-loop	To activate the <i>Loop guard</i> function on a <i>Root port</i> , <i>Alternate port</i> , or <i>Backup port</i> .
exit	To leave the interface mode.
show spanning-tree port x/y	To display the parameters of the port for checking.

12.5 Link Aggregation

The *Link Aggregation* function using the single switch method helps you overcome 2 limitations with Ethernet links, namely bandwidth, and redundancy.

The *Link Aggregation* function helps you overcome bandwidth limitations of individual ports. The *Link Aggregation* function lets you combine 2 or more connections into one logical connection between 2 devices. The parallel links increase the bandwidth between the 2 devices.

You typically use the *Link Aggregation* function on the network backbone. The function provides you an inexpensive way to incrementally increase bandwidth.

Furthermore, the *Link Aggregation* function provides for redundancy with a seamless failover. When a link goes down, with 2 or more links set up in parallel, the other links in the group continue to forward the data packets.

The device uses a hash option to determine load balancing across the port group. Tagging the egress data packets lets the device transmit associated packets across the same link.

The default settings for a new *Link Aggregation* instance are as follows:

- ▶ In the *Configuration* frame, the value in the *Hashing option* field is `sourceDestMacVlan`.
- ▶ In the *Active* column, the checkbox is marked.
- ▶ In the *Send trap (Link up/down)* column, the checkbox is marked.
- ▶ In the *Static link aggregation* column, the checkbox is unmarked.
- ▶ In the *Hashing option* column, the value is `sourceDestMacVlan`.
- ▶ In the *Active ports (min.)* column, the value is `1`.

12.5.1 Methods of Operation

The device operates on the Single Switch method. The Single Switch method provides you an inexpensive way to grow the network. The single switch method states that you need one device on each side of a link to provide the physical ports. The device balances the network load across the group member ports.

The device also uses the Same Link Speed method in which the group member ports operate in full-duplex, point-to-point links having the same transmission rate. The first port that you add to the group is the master port and determines the bandwidth for the other member ports of the Link Aggregation Group.

The device lets you set a maximum of 2 Link Aggregation groups. The number of useable ports per Link Aggregation group depends on the device.

Hash Algorithm

The frame distributor is responsible for receiving frames from the end devices and transmitting them over the Link Aggregation Group. The frame distributor implements a distribution algorithm responsible for choosing the link used for transmitting any given packet. The hash option helps you achieve load balancing across the group.

The following list contains options which you set for link selection.

- ▶ Source MAC address, VLAN ID, EtherType, and receiving port
- ▶ Destination MAC address, VLAN ID, EtherType, and receiving port

- ▶ Source/Destination MAC address, VLAN ID, EtherType, and receiving port
- ▶ Source IP address and Source TCP/UDP port
- ▶ Destination IP address and destination TCP/UDP port
- ▶ Source/destination IP address and source/destination TCP/UDP port

Static and Dynamic Links

The device lets you set up static and dynamic links.

- ▶ **Static Links** - The administrator sets up and maintains the links manually. For example, when a link fails and there is a media converter between the devices, the media converter continues forwarding the data packets on the link, causing the link to fail. Another possibility is that cabling or an undetected configuration mistake causes undesirable network behavior. In this case, the network administrator manually changes the link setup to restore the data stream.
- ▶ **Dynamic Links** - The device confirms that the setup on the remote device is able to handle link aggregation and failover occurs automatically.

12.5.2 Link Aggregation Example

Connect multiple workstations using one aggregated link group between Switch 1 and 2. By aggregating multiple links, higher speeds are achievable without a hardware upgrade.

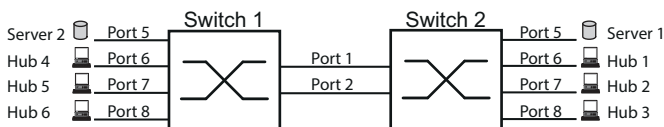



Figure 43: Link Aggregation Switch to Switch Network

Set up Switch 1 and 2 in the Graphical User Interface. To do this, perform the following steps:

- Open the [Switching > L2-Redundancy > Link Aggregation](#) dialog.
- Click the  button.
The dialog displays the [Create](#) window.
- From the [Trunk port](#) drop-down list, select the instance number of the link aggregation group.
- From the [Port](#) drop-down list, select port [1/1](#).
- Click the [Ok](#) button.
- Repeat the preceding steps and select the port [1/2](#).
- Click the [Ok](#) button.
- Apply the settings temporarily. To do this, click the  button.

enable	To change to the Privileged EXEC mode.
configure	To change to the Configuration mode.
link-aggregation add lag/1	To add a Link Aggregation Group lag/1 .
link-aggregation modify lag/1 addport 1/1	To add port 1/1 to the Link Aggregation Group.
link-aggregation modify lag/1 addport 1/2	To add port 1/2 to the Link Aggregation Group.

12.6 Link Backup

Link Backup provides a redundant link for the data packets on Layer 2 devices. When the device detects an error on the primary link, the device transfers the data packets to the backup link. You typically use Link Backup in service-provider or enterprise networks.

You set up the backup links in pairs, one as a primary and one as a backup. When providing redundancy for enterprise networks for example, the device lets you set up more than one pair. The maximum number of link backup pairs is: total number of physical ports / 2. Furthermore, when the state of a port participating in a link backup pair changes, the device sends an SNMP trap.

When configuring link backup pairs, remember the following rules:

- ▶ A link pair consists of any combination of physical ports. For example, one port is a 100 Mbit port and the other is a 1000 Mbit SFP port.
- ▶ A specific port is a member of one link backup pair at any given time.
- ▶ Verify that the ports of a link backup pair are members of the same VLAN with the same VLAN ID. When the *Primary port* or *Backup port* is a member of a VLAN, assign the second port of the pair to the same VLAN.

The default setting for this function is inactive without any link backup pairs.

Note: Verify that the Spanning Tree Protocol (STP) is disabled on the Link Backup ports.

12.6.1 Fail Back Description

Link Backup also lets you set up a Fail Back option. When you activate the *Fail back* function and the *Primary port* returns to normal operation, the device first blocks the data packets on the *Backup port* and then forwards the data packets to the *Primary port*. This process helps protect the device from causing loops in the network.

When the *Primary port* returns to the link up and active state, the device supports 2 modes of operation:

- ▶ When you inactivate *Fail back*, the *Primary port* remains in the *blocking* state until the backup link fails.
- ▶ When you activate *Fail back*, and after the *Fail back delay [s]* timer expires, the *Primary port* returns to the *forwarding* state and the *Backup port* changes to down.

In the cases listed above, the port forcing its link to forward the data packets, first sends a *Topology Change* packet to the remote device. The *Topology Change* packet helps the remote device quickly relearn the MAC addresses.

12.6.2 Application example for the Link Backup function

In the example network below, you connect ports *2/3* and *2/4* on Switch A to the uplink Switches B and C. When you set up the ports as a Link Backup pair, one of the ports forwards the data packets and the other port is in the *blocking* state.

The *Primary port 2/3* on Switch A, is the active port and is forwarding the data packets to port 1 on Switch B. Port *2/4* on Switch A is the *Backup port* and blocks the data packets.

When Switch A disables port *2/3* because of a detected error, port *2/4* on Switch A starts forwarding data packets to port 2 on Switch C.

When port *2/3* returns to the active state, “no shutdown“, with *Fail back* activated, and *Fail back delay [s]* set to 30 seconds. After the timer expires, port *2/4* first blocks the data packets and then port *2/3* starts forwarding data packets.

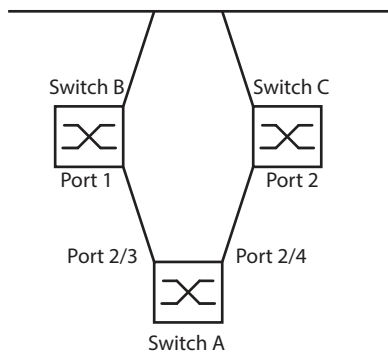



Figure 44: *Link Backup* example network

The following tables contain examples of parameters to set up Switch A.

Perform the following steps:

- Open the *Switching > L2-Redundancy > Link Backup* dialog.
- Enter a new Link Backup pair in the table:
 - Click the  button.
The dialog displays the *Create* window.
 - From the *Primary port* drop-down list, select port *2/3*.
From the *Backup port* drop-down list, select port *2/4*.
 - Click the *Ok* button.
- In the *Description* textbox, enter *Link_Backup_1* as the name for the backup pair.
- To activate the *Fail back* function for the link backup pair, mark the *Fail back* checkbox.
- Set the fail back timer for the link backup pair, enter *30 s* in *Fail back delay [s]*.
- To activate the link backup pair, mark the *Active* checkbox.
- To enable the function, select the *On* radio button in the *Operation* frame.

enable	To change to the Privileged EXEC mode.
configure	To change to the Configuration mode.
interface 2/3	To change to the interface configuration mode of interface <i>2/3</i> .
link-backup add 2/4	To add a Link Backup instance where port <i>2/3</i> is the <i>Primary port</i> and port <i>2/4</i> is the <i>Backup port</i> .
link-backup modify 2/4 description Link_Backup_1	To specify the string <i>Link_Backup_1</i> as the name of the backup pair.
link-backup modify 2/4 failback-status enable	To enable the fail back timer.
link-backup modify 2/4 failback-time 30	To specify the fail back delay time as <i>30 s</i> .
link-backup modify 2/4 status enable	To enable the Link Backup instance.
exit	To change to the Configuration mode.
link-backup operation	To enable the <i>Link Backup</i> function globally in the device.

13 Operation diagnosis

The device provides you with the following diagnostic tools:

- ▶ Sending SNMP traps
- ▶ Monitoring the Device Status
- ▶ Out-of-Band signaling using the signal contact
- ▶ Event counter at port level
- ▶ Detecting non-matching duplex modes
- ▶ Auto-Disable
- ▶ Displaying the SFP status
- ▶ Topology discovery
- ▶ Detecting IP address conflicts
- ▶ Detecting loops
- ▶ Reports
- ▶ Monitoring data stream on a port (port mirroring)
- ▶ Syslog
- ▶ Event log
- ▶ Cause and action management during selftest

13.1 Sending SNMP traps

The device immediately reports unusual events which occur during normal operation to the network management station. This is done by messages called SNMP traps that bypass the polling procedure (“polling” means querying the data stations at regular intervals). SNMP traps allow you to react quickly to unusual events.

Examples of such events are:

- ▶ Hardware reset
- ▶ Changes to the configuration
- ▶ Segmentation of a port

The device sends SNMP traps to various hosts to increase the transmission reliability for the messages. The unacknowledged SNMP trap message consists of a packet containing information about an unusual event.

The device sends SNMP traps to those hosts specified in the trap destination table. The device lets you set up the trap destination table with the network management station using SNMP.

13.1.1 List of SNMP traps

The following table displays possible SNMP traps sent by the device.

Table 33: Possible SNMP traps

Name of the SNMP trap	Meaning
authenticationFailure	When a station attempts to access an agent without authorisation, the device sends this trap.
coldStart	Sent after the system startup.
hm2DevMonSenseExtNvmRemoval	When the external memory has been removed, the device sends this trap.

Table 33: Possible SNMP traps (cont.)

Name of the SNMP trap	Meaning
linkDown	When the connection on a port is interrupted, the device sends this trap.
linkUp	When connection is established to a port, the device sends this trap.
hm2DevMonSenseHumidity	When the humidity exceeds or falls below the specified threshold values, the device sends this trap.
hm2DevMonSensePSState	When the status of a power supply unit changes, the device sends this trap.
hm2SigConStateChange	When the status of the signal contact changes in the operation monitoring, the device sends this trap.
newRoot	When the sending agent becomes the new root of the spanning tree, the device sends this trap.
topologyChange	When the port changes from blocking to forwarding or from forwarding to blocking , the device sends this trap.
alarmRisingThreshold	When the <i>RMON input</i> exceeds its upper threshold, the device sends this trap.
alarmFallingThreshold	When the <i>RMON input</i> goes below its lower threshold, the device sends this trap.
hm2AgentPortSecurityViolation	When a MAC address detected on this port does not match the current settings of the parameter <i>hm2AgentPortSecurityEntry</i> , the device sends this trap.
hm2DiagSelftestActionTrap	When a self test for the four categories <i>task</i> , <i>resource</i> , <i>software</i> , and <i>hardware</i> is performed according to the specified settings, the device sends this trap.
hm2MrpReconfig	When the configuration of the MRP Ring changes, the device sends this trap.
hm2DiagIfaceUtilizationTrap	When the actual value of the interface exceeds the specified upper threshold value or falls below the specified lower threshold value, the device sends this trap.
hm2LogAuditStartNextSector	When the audit trail after completing one sector starts a new one, the device sends this trap.
hm2PtpSynchronizationChance	When the status of the PTP synchronization has been changed, the device sends this trap.
hm2ConfigurationSavedTrap	After the device has successfully saved its settings locally, the device sends this trap.
hm2ConfigurationChangedTrap	When you change the settings of the device for the first time after it has been saved locally, the device sends this trap.
hm2PlatformStpInstanceLoopInconsistentStartTrap	When the port in this STP instance changes to the <i>Loop Inconsistent</i> status, the device sends this trap.
hm2PlatformStpInstanceLoopInconsistentEndTrap	When the port in this STP instance leaves the <i>Loop Inconsistent</i> status receiving a BPDU packet, the device sends this trap.

13.1.2 SNMP traps for configuration activity



After you save a configuration in the memory, the device sends a [hm2ConfigurationSavedTrap](#). This SNMP trap contains both the state variables of non-volatile memory (*NVM*) and external memory (*ENVM*) indicating if the running configuration is in sync with the non-volatile memory, and with the external memory. You can also trigger this SNMP trap by transferring a configuration file onto the device, replacing the active saved configuration.

Furthermore, the device sends a [hm2ConfigurationChangedTrap](#), whenever you change the local configuration, indicating a mismatch between the running and saved configuration.

13.1.3 SNMP trap setting

The device lets you send an SNMP trap as a reaction to specific events. Set up at least one trap destination that receives SNMP traps.

Perform the following steps:

- Open the [Diagnostics > Status Configuration > Alarms \(Traps\)](#) dialog.
- Click the  button.
The dialog displays the [Create](#) window.
- In the [Name](#) frame, specify the name that the device uses to identify itself as the source of the SNMP trap.
- In the [Address](#) frame, specify the IP address of the trap destination to which the device sends the SNMP traps.
- In the [Active](#) column, select the entries that the device takes into account when it sends SNMP traps.
- Apply the settings temporarily. To do this, click the  button.

For example, in the following dialogs you specify when the device triggers an SNMP trap:

- ▶ [Basic Settings > Port](#) dialog
- ▶ [Network Security > Port Security](#) dialog
- ▶ [Switching > L2-Redundancy > Link Aggregation](#) dialog
- ▶ [Diagnostics > Status Configuration > Device Status](#) dialog
- ▶ [Diagnostics > Status Configuration > Security Status](#) dialog
- ▶ [Diagnostics > Status Configuration > Signal Contact](#) dialog
- ▶ [Diagnostics > Status Configuration > MAC Notification](#) dialog
- ▶ [Diagnostics > System > IP Address Conflict Detection](#) dialog
- ▶ [Diagnostics > System > Selftest](#) dialog
- ▶ [Diagnostics > Ports > Port Monitor](#) dialog

13.1.4 ICMP messaging

The device lets you use the Internet Control Message Protocol (ICMP) for diagnostic applications, for example ping and trace route. The device also uses ICMP for time-to-live and discarding messages in which the device forwards an ICMP message back to the packet source device.

Use the ping network tool to test the path to a particular host across an IP network. The traceroute diagnostic tool displays paths and transit delays of packets across a network.

13.2 Monitoring the Device Status

The device status provides an overview of the overall condition of the device. Many process visualization systems record the device status for a device to present its condition in graphic form.

The device displays its current status as *error* or *ok* in the *Device status* frame. The device determines this status from the individual monitoring results.

The device lets you:

- ▶ Out-of-Band signalling using a signal contact
- ▶ signal the changed device status by sending an SNMP trap
- ▶ detect the device status in the *Basic Settings > System* dialog of the Graphical User Interface
- ▶ query the device status in the Command Line Interface

The *Global* tab of the *Diagnostics > Status Configuration > Device Status* dialog lets you set up the device to send a trap to the management station for the following events:

- ▶ Incorrect supply voltage
 - at least one of the 2 supply voltages is not operating
 - the internal supply voltage is not operating
- ▶ When you operate the device outside of the user-specified temperature threshold values
- ▶ When you operate the device outside of the user-specified humidity threshold values
- ▶ Loss of the redundancy (when the device operates in the *Ring Manager* mode)
- ▶ The interruption of link connection(s)
Set up at least one port for this feature. In the table of the *Port* tab, *Propagate connection error* column, you specify for which ports the device will propagate a link interruption to the device status. In the default setting, link connection monitoring is inactive.
- ▶ The removal of the external memory
The configuration profile in the external memory does not match the settings in the device.

Select the corresponding entries to decide which events the device status includes.

Note: With a non-redundant voltage supply, the device reports the absence of a supply voltage. To disable this message, feed the supply voltage over both inputs or ignore the monitoring.

13.2.1 Events which can be monitored

Table 34: *Device Status* events

Name	Meaning
<i>Connection errors</i>	Activate this function to monitor every port link event in which the <i>Propagate connection error</i> checkbox is marked.
<i>Temperature</i>	Activate this function to monitor if the temperature exceeds the specified upper threshold value or falls below the specified lower threshold value.
<i>External memory removal</i>	Activate this function to monitor the presence of an external storage device.
<i>External memory not in sync</i>	The device monitors synchronization between the device settings and the configuration profile stored in the external memory (<i>ENVM</i>).
<i>Ring redundancy</i>	When ring redundancy is present, activate this function to monitor.
<i>Humidity</i>	Activate this function to monitor when the humidity exceeds or falls below the specified threshold values.
<i>Power supply</i>	Activate this function to monitor the power supply.

13.2.2 Configuring the Device Status

Perform the following steps:

- Open the *Diagnostics > Status Configuration > Device Status* dialog, *Global* tab.
- For the parameters to be monitored, mark the checkbox in the *Monitor* column.
- To send an SNMP trap to the management station, activate the *Send trap* function in the *Traps* frame.
- In the *Diagnostics > Status Configuration > Alarms (Traps)* dialog, add at least one trap destination that receives SNMP traps.
- Apply the settings temporarily. To do this, click the button.
- Open the *Basic Settings > System* dialog.
- To monitor the temperature, in the *System data* frame, you specify the temperature threshold values.
- To monitor the humidity, in the *System data* frame, you specify the humidity threshold values.
- Apply the settings temporarily. To do this, click the button.

enable

To change to the Privileged EXEC mode.

configure

To change to the Configuration mode.

device-status trap

To send an SNMP trap when the device status changes.

device-status monitor envm-not-in-sync

To monitor the configuration profiles in the device and in the external memory.

The *Device status* changes to *error* in the following situations:

- The configuration profile only exists in the device.
- The configuration profile in the device differs from the configuration profile in the external memory.

device-status monitor envm-removal

To monitor the active external memory. When you remove the active external memory from the device, the value in the *Device status* frame changes to *error*.

device-status monitor power-supply 1

To monitor the power supply unit 1. When the device has a detected power supply fault, the value in the *Device status* frame changes to *error*.

<code>device-status monitor ring-redundancy</code>	To monitor the ring redundancy. The <i>Device status</i> changes to <i>error</i> in the following situations: <ul style="list-style-type: none">• The redundancy function becomes active (loss of redundancy reserve).• The device is a normal ring participant and detects an error in its settings.
<code>device-status monitor temperature</code>	To monitor the temperature in the device. When the temperature exceeds the specified upper threshold value or falls below the specified lower threshold value, the value in the <i>Device status</i> frame changes to <i>error</i> .
<code>device-status monitor humidity</code>	To monitor the humidity in the device. When the humidity exceeds or falls below the specified threshold values, the value in the <i>Device status</i> frame changes to <i>error</i> .

To enable the device to monitor an active link without a connection, first enable the global function, then enable the individual ports.

Perform the following steps:

- Open the *Diagnostics > Status Configuration > Device Status* dialog, *Global* tab.
- For the *Connection errors* parameter, mark the checkbox in the *Monitor* column.
- Open the *Diagnostics > Status Configuration > Device Status* dialog, *Port* tab.
- For the *Propagate connection error* parameter, mark the checkbox in the column of the ports to be monitored.
- Apply the settings temporarily. To do this, click the button.

<code>enable</code>	To change to the Privileged EXEC mode.
<code>configure</code>	To change to the Configuration mode.
<code>device-status monitor link-failure</code>	To monitor the ports/interfaces link. When the link interrupts on a monitored port/interface, the value in the <i>Device status</i> frame changes to <i>error</i> .
<code>interface 1/1</code>	To change to the interface configuration mode of interface <i>1/1</i> .
<code>device-status link-alarm</code>	To monitor the port/interface link. When the link interrupts on a monitored port/interface, the value in the <i>Device status</i> frame changes to <i>error</i> .

Note: The above commands activate monitoring and trapping for the supported components. When you want to activate or deactivate monitoring for individual components, you will find the corresponding syntax in the “Command Line Interface” reference manual or in the help of the Command Line Interface console. To display the help in Command Line Interface, insert a question mark `?` and press the <Enter> key.

13.2.3 Displaying the Device Status

Perform the following steps:

 Open the *Basic Settings > System* dialog.

 enable

show device-status all

To change to the Privileged EXEC mode.

To display the device status and the setting for the device status determination.

13.3 Security Status

The Security Status provides an overview of the overall security of the device. Many processes aid in system visualization by recording the security status of the device and then presenting its condition in graphic form. The device displays the overall security status in the [Basic Settings > System](#) dialog, [Security status](#) frame.

In the [Global](#) tab of the [Diagnostics > Status Configuration > Security Status](#) dialog the device displays its current status as *error* or *ok* in the [Security status](#) frame. The device determines this status from the individual monitoring results.

The device lets you:

- ▶ Out-of-Band signalling using a signal contact
- ▶ signal the changed security status by sending an SNMP trap
- ▶ detect the security status in the [Basic Settings > System](#) dialog of the Graphical User Interface
- ▶ query the security status in the Command Line Interface

13.3.1 Events which can be monitored

Perform the following steps:

- Specify the events that the device monitors.
- For the corresponding parameter, mark the checkbox in the [Monitor](#) column.

Table 35: [Security Status events](#)

Name	Meaning
Password default settings unchanged	After installation change the passwords to increase security. When active and the default passwords remain unchanged, the device displays an alarm.
Min. password length shorter than 8	Create passwords more than 8 characters long to maintain a high security posture. When active, the device monitors the Min. password length setting.
Password policy settings deactivated	The device monitors the settings located in the Device Security > User Management dialog for password policy requirements.
User account password policy check deactivated	The device monitors the settings of the Policy check checkbox. When Policy check is inactive, the device sends an SNMP trap.
Telnet server active	Activate this function to monitor when the Telnet function is active.
HTTP server active	Activate this function to monitor when the HTTP function is active.
SNMP unencrypted	Activate this function to monitor when the SNMPv1 or SNMPv2 function is active.
Access to system monitor with serial interface possible	The device monitors the System Monitor status.
Saving the configuration profile on the external memory possible	The device monitors the possibility to save settings to the external non-volatile memory.
Link interrupted on enabled device ports	The device monitors the link status of active ports.
Access with HiDiscovery possible	Activate this function to monitor when the HiDiscovery function has write access to the device.

Table 35: *Security Status events (cont.)*

Name	Meaning
<i>Load unencrypted config from external memory</i>	The device monitors the security settings for loading the configuration from the external NVM.
<i>Self-signed HTTPS certificate present</i>	The device monitors the HTTPS server for self-generated digital certificates.
<i>Modbus TCP active</i>	The device monitors the Modbus TCP/IP protocol activation setting.

13.3.2 Configuring the Security Status

Perform the following steps:

- Open the *Diagnostics > Status Configuration > Security Status* dialog, *Global* tab.
- For the parameters to be monitored, mark the checkbox in the *Monitor* column.
- To send an SNMP trap to the management station, activate the *Send trap* function in the *Traps* frame.
- Apply the settings temporarily. To do this, click the button.
- In the *Diagnostics > Status Configuration > Alarms (Traps)* dialog, add at least one trap destination that receives SNMP traps.

enable	To change to the Privileged EXEC mode.
configure	To change to the Configuration mode.
security-status monitor pwd-change	To monitor the password for the locally set up user account <i>admin</i> . When the password for the <i>admin</i> user account is the default setting, the value in the <i>Security status</i> frame changes to <i>error</i> .
security-status monitor pwd-min-length	To monitor the value specified in the <i>Min. password length</i> policy. When the value for the <i>Min. password length</i> policy is less than 8, the value in the <i>Security status</i> frame changes to <i>error</i> .
security-status monitor pwd-policy-config	To monitor the password policy settings. When the value for at least one of the following policies is specified as 0, the value in the <i>Security status</i> frame changes to <i>error</i> . <ul style="list-style-type: none"> • <i>Upper-case characters (min.)</i> • <i>Lower-case characters (min.)</i> • <i>Digits (min.)</i> • <i>Special characters (min.)</i>
security-status monitor pwd-policy-inactive	To monitor the password policy settings. When the value for at least one of the following policies is specified as 0, the value in the <i>Security status</i> frame changes to <i>error</i> .
security-status monitor telnet-enabled	To monitor the Telnet server. When you enable the Telnet server, the value in the <i>Security status</i> frame changes to <i>error</i> .

security-status monitor http-enabled	To monitor the HTTP server. When you enable the HTTP server, the value in the <i>Security status</i> frame changes to <i>error</i> .
security-status monitor snmp-unsecure	To monitor the SNMP server. When at least one of the following conditions applies, the value in the <i>Security status</i> frame changes to <i>error</i> : <ul style="list-style-type: none">The <i>SNMPv1</i> function is enabled.The <i>SNMPv2</i> function is enabled.The encryption for SNMPv3 is disabled. You enable the encryption in the <i>Device Security > User Management</i> dialog, in the <i>SNMP encryption type</i> field.
security-status monitor sysmon-enabled	To monitor the activation of the <i>System Monitor 1</i> function in the device.
security-status monitor extnvm-upd-enabled	To monitor the activation of the external non volatile memory update.
security-status trap	To send an SNMP trap when the device status changes.

To enable the device to monitor an active link without a connection, first enable the global function, then enable the individual ports.

Perform the following steps:

- Open the *Diagnostics > Status Configuration > Security Status* dialog, *Global* tab.
- For the *Link interrupted on enabled device ports* parameter, mark the checkbox in the *Monitor* column.
- Apply the settings temporarily. To do this, click the button.
- Open the *Diagnostics > Status Configuration > Device Status* dialog, *Port* tab.
- For the *Link interrupted on enabled device ports* parameter, mark the checkbox in the column of the ports to be monitored.
- Apply the settings temporarily. To do this, click the button.

enable	To change to the Privileged EXEC mode.
configure	To change to the Configuration mode.
security-status monitor no-link-enabled	To monitor the link on active ports. When the link interrupts on an active port, the value in the <i>Security status</i> frame changes to <i>error</i> .
interface 1/1	To change to the interface configuration mode of interface <i>1/1</i> .
security-status monitor no-link	To monitor the link on interface/port <i>1</i> .

13.3.3 Displaying the Security Status

Perform the following steps:

 Open the *Basic Settings > System* dialog.

 enable

show security-status all

To change to the Privileged EXEC mode.

To display the security status and the setting for the security status determination.

13.4 Out-of-Band signaling

The device uses the signal contact to control external devices and monitor device functions. Function monitoring lets you perform remote diagnostics.

The device reports the operating status using a break in the potential-free signal contact (relay contact, closed circuit) for the selected mode. The device monitors the following functions:

- ▶ Incorrect supply voltage
 - at least one of the 2 supply voltages is not operating
 - the internal supply voltage is not operating
- ▶ When you operate the device outside of the user-specified temperature threshold values
- ▶ When you operate the device outside of the user-specified humidity threshold values
- ▶ Events for ring redundancy
 - Loss of the redundancy (when the device operates in the *Ring Manager* mode)
 - In the default setting, ring redundancy monitoring is inactive. The device is a normal ring participant and detects an error in the local configuration.
- ▶ The interruption of link connection(s)
 - Set up at least one port for this feature. In the *Propagate connection error* frame, you specify which ports the device signals for a link interruption. In the default setting, link monitoring is inactive.
- ▶ The removal of the external memory
 - The configuration profile in the external memory does not match the settings in the device.

Select the corresponding entries to decide which events the device status includes.

Note: With a non-redundant voltage supply, the device reports the absence of a supply voltage. To disable this message, feed the supply voltage over both inputs or ignore the monitoring.

13.4.1 Controlling the Signal contact

With the *Manual setting* mode you control this signal contact remotely.

Application options:

- ▶ Simulation of an error detected during SPS error monitoring
- ▶ Remote control of a device using SNMP, such as switching on a camera

Perform the following steps:

- Open the *Diagnostics > Status Configuration > Signal Contact* dialog, *Global* tab.
- To control the signal contact manually, in the *Configuration* frame, select the *Manual setting* item from the *Mode* drop-down list.
- To open the signal contact, you select the *open* radio button in the *Configuration* frame.
- To close the signal contact, you select the *close* radio button in the *Configuration* frame.
- Apply the settings temporarily. To do this, click the  button.

enable

configure

To change to the Privileged EXEC mode.

To change to the Configuration mode.

signal-contact 1 mode manual	To select the manual setting mode for signal contact 1.
signal-contact 1 state open	To open signal contact 1.
signal-contact 1 state closed	To close signal contact 1.

13.4.2 Monitoring the Device and Security Statuses

In the *Configuration* field, you specify which events the signal contact indicates.

▶ *Device status*

Using this setting the signal contact indicates the status of the parameters monitored in the *Diagnostics > Status Configuration > Device Status* dialog.

▶ *Security status*

Using this setting the signal contact indicates the status of the parameters monitored in the *Diagnostics > Status Configuration > Security Status* dialog.

▶ *Device/Security status*

Using this setting the signal contact indicates the status of the parameters monitored in the *Diagnostics > Status Configuration > Device Status* and the *Diagnostics > Status Configuration > Security Status* dialog.

Configuring the operation monitoring

Perform the following steps:

- Open the *Diagnostics > Status Configuration > Signal Contact* dialog, *Global* tab.
- To monitor the device functions using the signal contact, in the *Configuration* frame, specify the value *Monitoring correct operation* in the *Mode* field.
- For the parameters to be monitored, mark the checkbox in the *Monitor* column.
- To send an SNMP trap to the management station, activate the *Send trap* function in the *Traps* frame.
- Apply the settings temporarily. To do this, click the ✓ button.
- In the *Diagnostics > Status Configuration > Alarms (Traps)* dialog, add at least one trap destination that receives SNMP traps.
- Apply the settings temporarily. To do this, click the ✓ button.
- You specify the temperature threshold values for the temperature monitoring in the *Basic Settings > System* dialog.
- You specify the humidity threshold values for the humidity monitoring in the *Basic Settings > System* dialog.

enable	To change to the Privileged EXEC mode.
configure	To change to the Configuration mode.
signal-contact 1 monitor temperature	To monitor the temperature in the device. When the temperature exceeds the specified upper threshold value or falls below the specified lower threshold value, the signal contact opens.

signal-contact 1 monitor humidity	To monitor the humidity in the device. When the humidity exceeds or falls below the specified threshold values, the signal contact opens.
signal-contact 1 monitor ring-redundancy	To monitor the ring redundancy. The signal contact opens in the following situations: <ul style="list-style-type: none">• The redundancy function becomes active (loss of redundancy reserve).• The device is a normal ring participant and detects an error in its settings.
signal-contact 1 monitor link-failure	To monitor the ports/interfaces link. When the link interrupts on a monitored port/interface, the signal contact opens.
signal-contact 1 monitor envm-removal	To monitor the active external memory. When you remove the active external memory from the device, the signal contact opens.
signal-contact 1 monitor envm-not-in-sync	To monitor the configuration profiles in the device and in the external memory. The signal contact opens in the following situations: <ul style="list-style-type: none">• The configuration profile only exists in the device.• The configuration profile in the device differs from the configuration profile in the external memory.
signal-contact 1 monitor power-supply 1	To monitor the power supply unit 1. When the device has a detected power supply fault, the signal contact opens.
signal-contact 1 monitor module-removal 1	To monitor module 1. When you remove module 1 from the device, the signal contact opens.
signal-contact 1 trap	To send an SNMP trap when the status of the operation monitoring changes.
no signal-contact 1 trap	To disable the SNMP trap

To enable the device to monitor an active link without a connection, first enable the global function, then enable the individual ports.

Perform the following steps:

- In the *Monitor* column, activate the *Link interrupted on enabled device ports* function.
- Open the *Diagnostics > Status Configuration > Device Status* dialog, *Port* tab.

enable	To change to the Privileged EXEC mode.
configure	To change to the Configuration mode.

signal-contact 1 monitor link-failure	To monitor the ports/interfaces link. When the link interrupts on a monitored port/interface, the signal contact opens.
interface 1/1	To change to the interface configuration mode of interface 1/1.
signal-contact 1 link-alarm	To monitor the port/interface link. When the link interrupts on the port/interface, the signal contact opens.

Events which can be monitored

Table 36: *Device Status* events

Name	Meaning
<i>Connection errors</i>	Activate this function to monitor every port link event in which the <i>Propagate connection error</i> checkbox is marked.
<i>Temperature</i>	Activate this function to monitor if the temperature exceeds the specified upper threshold value or falls below the specified lower threshold value.
<i>External memory removed</i>	Activate this function to monitor the presence of an external storage device.
<i>External memory not in sync with NVM</i>	The device monitors synchronization between the device settings and the configuration profile stored in the external memory (<i>ENVN</i>).
<i>Ring redundancy</i>	When ring redundancy is present, activate this function to monitor.
<i>Humidity</i>	Activate this function to monitor when the humidity exceeds or falls below the specified threshold values.
<i>Power supply</i>	Activate this function to monitor the power supply.

Displaying the signal contact status

The device gives you additional options for displaying the status of the signal contact:

- ▶ Display in the Graphical User Interface
- ▶ Query in the Command Line Interface

Perform the following steps:

- Open the *Basic Settings > System* dialog.
The *Signal contact status* frame displays the signal contact status and informs you about alarms that have occurred.

- show signal-contact 1 all
To display the settings for the specified signal contact.

13.5 Port event counter

The port statistics table assists experienced network administrators in identifying potential network interruptions.

This table displays the contents of various event counters. The packet counters add up the events sent and the events received. In the [Basic Settings > Restart](#) dialog, you can reset the event counters.

Table 37: Examples indicating known weaknesses

Counter	Indication of known possible weakness
Received fragments	<ul style="list-style-type: none">• Non-functioning controller of the connected device• Electromagnetic interference in the transmission medium
CRC Error	<ul style="list-style-type: none">• Non-functioning controller of the connected device• Electromagnetic interference in the transmission medium• Inoperable component in the network
Collisions	<ul style="list-style-type: none">• Non-functioning controller of the connected device• Network over extended/lines too long• Collision or a detected fault with a data packet

Perform the following steps:

- To display the event counter, open the [Basic Settings > Port](#) dialog, [Statistics](#) tab.
- To reset the counters, in the [Basic Settings > Restart](#) dialog, click the [Clear port statistics](#) button.

13.5.1 Detecting non-matching duplex modes

Potential problems occur when 2 ports directly connected to each other have mismatched duplex modes. These potential problems are difficult to detect. The automatic detection and reporting of this situation has the benefit of recognizing mismatched duplex modes before potential problems occur.

This situation arises from an incorrect configuration, for example, deactivation of the automatic configuration on the remote port.

A typical effect of this non-matching is that at a low data rate, the connection seems to be functioning, but at a higher bi-directional data stream level the local device records a lot of detected CRC errors, and the connection falls significantly below its nominal capacity.

The device lets you detect this situation and report it to the network management station. In the process, the device evaluates the detected error counters of the port in the context of the port settings.

Possible causes of port error events

The following table lists the duplex operating modes for TX ports, with the possible fault events. The meanings of terms used in the table are as follows:

- ▶ Duplex problem detected
 - Mismatched duplex modes.

- ▶ EMI
Electromagnetic interference.
- ▶ Network extension
The network extension is too great, or too many cascading hubs.
- ▶ Collisions, *Late Collisions*
In half-duplex mode, collisions mean normal operation.
In full-duplex mode, no incrementation of the port counters for collisions or *Late Collisions*.
- ▶ CRC Error
The device evaluates these detected errors as non-matching duplex modes in the manual full-duplex mode.

Table 38: Evaluation of non-matching of the duplex mode

No.	Automatic configuration	Current duplex mode	Detected error events (≥ 10 after link up)	Duplex modes	Possible causes
1	marked	Half-duplex	None	OK	
2	marked	Half-duplex	Collisions	OK	
3	marked	Half-duplex	Late Collisions	Duplex problem detected	Potential duplex problem, EMI, network extension
4	marked	Half-duplex	CRC Error	OK	EMI
5	marked	Full-duplex	None	OK	
6	marked	Full-duplex	Collisions	OK	EMI
7	marked	Full-duplex	Late Collisions	OK	EMI
8	marked	Full-duplex	CRC Error	OK	EMI
9	unmarked	Half-duplex	None	OK	
10	unmarked	Half-duplex	Collisions	OK	
11	unmarked	Half-duplex	Late Collisions	Duplex problem detected	Potential duplex problem, EMI, network extension
12	unmarked	Half-duplex	CRC Error	OK	EMI
13	unmarked	Full-duplex	None	OK	
14	unmarked	Full-duplex	Collisions	OK	EMI
15	unmarked	Full-duplex	Late Collisions	OK	EMI
16	unmarked	Full-duplex	CRC Error	Duplex problem detected	Potential duplex problem, EMI

13.6 Auto-Disable

The device can disable a port on various user-selectable events, such as a detected error or change of condition. Each of these events leads to the shutdown of the port. To recover the port, either clear the condition that caused the port shutdown or specify a timer to automatically re-enable the port.

If the device disables the port, then the device no longer forwards data packets to and from that port. The port LED blinks green 3 times per period and indicates the reason for disabling. In addition, the device generates a log file entry which lists the causes of the deactivation. When you re-enable the port after a timeout using the *Auto-Disable* function, the device generates a log entry.

The *Auto-Disable* function provides a recovery function which automatically enables an auto-disabled port after a user-defined time. When this function enables a port, the device sends an SNMP trap with the port number, but without a value for the *Reason* parameter.

The *Auto-Disable* function serves the following purposes:

- ▶ It assists the network administrator in port analysis.
- ▶ It reduces the possibility that this port causes the network to be instable.

The *Auto-Disable* function is available for the following functions:

- ▶ *Link flap* (*Port Monitor* function)
- ▶ *CRC/Fragments* (*Port Monitor* function)
- ▶ Duplex Mismatch detection (*Port Monitor* function)
- ▶ *Spanning Tree*
- ▶ *Port Security*
- ▶ *Overload detection* (*Port Monitor* function)
- ▶ *Link speed/Duplex mode detection* (*Port Monitor* function)

In the following example, you set up the device to disable a port due to detected violations to the threshold values specified the *Diagnostics > Ports > Port Monitor* dialog, *CRC/Fragments* tab, and then automatically re-enable a port.

Perform the following steps:

- Open the *Diagnostics > Ports > Port Monitor* dialog, *CRC/Fragments* tab.
- Verify that the threshold values specified in the table concur to your preferences for port 1/1.
- Open the *Diagnostics > Ports > Port Monitor* dialog, *Global* tab.
- To enable the function, select the *On* radio button in the *Operation* frame.
- To allow the device to disable the port due to detected errors, mark the checkbox in the *CRC/Fragments on* column for port 1/1.

- In the *Action* column you can choose how the device reacts to detected errors. In this example, the device disables port *1/1* for threshold value violations and then automatically re-enables the port.
 - ▶ To allow the device to disable and automatically re-enable the port, select the value *auto-disable* and set up the *Auto-Disable* function. The value *auto-disable* only works in conjunction with the *Auto-Disable* function.
 The device can also disable a port without auto re-enabling.
 - ▶ To allow the device to disable the port only, select the value *disable port*.
To manually re-enable a disabled port, select the table row of the port and click the  button.
 - ▶ When you set up the *Auto-Disable* function, the value *disable port* also automatically re-enables the port.
- Open the *Diagnostics > Ports > Port Monitor* dialog, *Auto-disable* tab.
- To allow the device to auto re-enable the port after it was disabled due to detected threshold value violations, mark the checkbox in the *CRC error* column.
- Open the *Diagnostics > Ports > Port Monitor* dialog, *Port* tab.
- Specify the delay time as 120 s in the *Reset timer [s]* column for the ports you want to enable.

Note: The *Reset* item lets you enable the port before the time specified in the *Reset timer [s]* column has expired.

enable	To change to the Privileged EXEC mode.
configure	To change to the Configuration mode.
interface 1/1	To change to the interface configuration mode of interface <i>1/1</i> .
port-monitor condition crc-fragments count 2000	To specify the CRC-Fragment counter to 2000 parts per million.
port-monitor condition crc-fragments interval 15	To set the measure interval to 15 seconds for CRC-Fragment detection.
auto-disable timer 120	To specify the waiting period of <i>120</i> seconds, after which the <i>Auto-disable</i> function re-enables the port.
exit	To change to the Configuration mode.
auto-disable reason crc-error	To activate the auto-disable CRC function.
port-monitor condition crc-fragments mode	To activate the CRC-Fragments condition to trigger an action.
port-monitor operation	To activate the <i>Port Monitor</i> function.

When the device disables a port due to threshold value violations, the device lets you use the following commands to manually reset the disabled port.

Perform the following steps:

enable	To change to the Privileged EXEC mode.
configure	To change to the Configuration mode.
interface 1/1	To change to the interface configuration mode of interface <i>1/1</i> .
auto-disable reset	To let you enable the port before the time has expired.

13.7 Displaying the SFP status

The SFP status display lets you look at the current SFP module connections and their properties. The properties include:

- ▶ module type
- ▶ serial number of media module
- ▶ temperature in ° C
- ▶ transmission power in mW
- ▶ receive power in mW

Perform the following step:

-  Open the *Diagnostics > Ports > SFP* dialog.

13.8 Topology discovery

IEEE 802.1AB defines the Link Layer Discovery Protocol (LLDP). LLDP lets you automatically detect the LAN network topology.

Devices with LLDP active:

- ▶ broadcast their connection and management information to neighboring devices on the shared LAN. When the receiving device has its *LLDP* function active, evaluation of the devices occur.
- ▶ receive connection and management information from neighbor devices on the shared LAN, provided these adjacent devices also have LLDP active.
- ▶ build a management information database and object definitions for storing information about adjacent devices with LLDP active.

As the main element, the connection information contains an exact, unique identifier for the connection end point: MAC (Service Access Point). This is made up of a device identifier which is unique on the entire network and a unique port identifier for this device.

- ▶ Chassis identifier (its MAC address)
- ▶ Port identifier (its port-MAC address)
- ▶ Description of port
- ▶ System name
- ▶ System description
- ▶ Supported system capabilities
- ▶ System capabilities currently active
- ▶ Interface ID of the management address
- ▶ VLAN-ID of the port
- ▶ Auto-negotiation status on the port
- ▶ Medium, half/full-duplex setting and port speed setting
- ▶ Information about the VLANs installed in the device (VLAN-ID and VLAN name, irrespective of whether the port is a VLAN participant).

A network management station can call up this information from devices with activated LLDP. This information lets the network management station map the topology of the network.

Non-LLDP-capable devices normally block the special Multicast LLDP IEEE MAC address used for information exchange. Non-LLDP-capable devices therefore discard LLDP packets. If you position a non-LLDP-capable device between 2 LLDP-capable devices, then the non-LLDP-capable device prohibits information exchanges between the 2 LLDP-capable devices.

The Management Information Base (MIB) for a device with LLDP capability holds the LLDP information in the `lldp` MIB and in the private `HM2-LLDP-EXT-HM-MIB` and `HM2-LLDP-MIB`.

13.8.1 Displaying the Topology discovery results

Display the topology of the network. To do this, perform the following step:

-  Open the *Diagnostics > LLDP > Topology Discovery* dialog, *LLDP* tab.

When you use a port to connect several devices, for example through a hub, the table contains a line for each connected device.

If you connect the port to devices with the topology discovery function active, then the devices exchange LLDP Data Units (LLDPDU) and the topology table displays these neighboring devices.

When a port connects only devices without an active topology discovery, the table contains a line for this port to represent the connected devices. This line contains the number of connected devices.

The MAC address table (forwarding database) contains MAC addresses of devices that the topology table hides for the sake of clarity.

13.8.2 LLDP-Med

LLDP for Media Endpoint Devices (LLDP-MED) is an extension to LLDP that operates between endpoint devices. Endpoints include devices such as IP phones, or other Voice over IP (VoIP) devices or servers and network devices such as switches. It specifically provides support for VoIP applications. LLDP-MED provides this support using an additional set of common type-length-value (TLV) advertisement messages, for capabilities discovery, network policy, Power over Ethernet, inventory management and location information.

The device supports the following TLV messages:

- ▶ capabilities TLV
Lets the LLDP-MED endpoints determine the capabilities that the connected device supports and what capabilities the device has enabled.
- ▶ Network policy TLV
Lets both network connectivity devices and endpoints advertise VLAN configurations and associated attributes for the specific application on that port. For example, the device notifies a phone of the VLAN number. The phone connects to a switch, obtain its VLAN number, and then starts communicating with the call control.

LLDP-MED provides the following functions:

- ▶ Network policy discovery, including VLAN ID, 802.1p priority and DSCP (Differentiated Services Code Point)
- ▶ Device location and topology discovery based on LAN-level MAC/port information
- ▶ Endpoint move detection notification, from network connectivity device to the associated VoIP management application
- ▶ Extended device identification for inventory management
- ▶ Identification of endpoint network connectivity capabilities, for example, multi-port IP Phone with embedded switch or bridge capability
- ▶ Application level interactions with the Link Layer Discovery Protocol (LLDP) elements to provide timely startup of LLDP to support rapid availability of an Emergency Call Service
- ▶ Applicability of LLDP-MED to Wireless LAN environments, support for Voice over Wireless LAN

13.9 Detecting loops

Loops in the network cause connection interruptions or data loss. This also applies to temporary loops. The automatic detection and reporting of this situation lets you detect it faster and diagnose it more easily.

An incorrect configuration causes loops, for example, deactivating Spanning Tree.

The device lets you detect the effects typically caused by loops and report this situation automatically to the network management station. You have the option here to specify the magnitude of the loop effects that trigger the device to send a report.

BPDUs sent from the *Designated port* and received on either a different port of the same device or the same port within a short time, is a typical effect of a loop.

To check if the device has detected a loop, perform the following steps:

- Open the *Switching > L2-Redundancy > Spanning Tree > Port* dialog, *CIST* tab.
- Check the value in the *Port state* and *Port role* fields. If the *Port state* field displays the value *discarding* and the *Port role* field displays the value *backup*, then the port is in a loop status.
or
- Open the *Switching > L2-Redundancy > Spanning Tree > Port* dialog, *Guards* tab.
- Check the value in the *Loop state* column. If the field displays the value *true*, then the port is in a loop status.

13.10 Reports

The following lists reports and buttons available for diagnostics:

- ▶ System Log file
The device logs device-internal events in the System Log file.
- ▶ Audit Trail
Logs successful commands and user comments. The file also includes SNMP logging.
- ▶ Persistent Logging
When the external memory is present, the device saves log entries in a file in the external memory. These files remain available even after powering off the device. The maximum size, maximum number of retainable files, and the severity of logged events are configurable. After obtaining the user-defined maximum size or maximum number of retainable files, the device archives the entries and starts a new file. The device deletes the oldest file and renames the other files to maintain the number of files set up. To review these files, use the Command Line Interface or copy them to an external server for future reference.
- ▶ [Download support information](#)
This button lets you download system information as a ZIP archive.

In service situations, these reports provide the technician with the necessary information.

13.10.1 Global settings

Using this dialog you enable or disable where the device sends reports, for example, to a Console, a syslog server, or a connection to the Command Line Interface. You also set at which severity level the device writes events into the reports.

Perform the following steps:

- Open the [Diagnostics > Report > Global](#) dialog.
- To send a report to the console, specify the desired level in the [Console logging](#) frame, [Severity](#) field.
- To enable the function, select the *On* radio button in the [Console logging](#) frame.
- Apply the settings temporarily. To do this, click the  button.

The device buffers logged events in 2 separate storage areas so that the device keeps log entries for urgent events. Specify the minimum severity for events that the device logs to the buffered storage area with a higher priority.

Perform the following steps:

- To send events to the buffer, specify the desired level in the [Buffered logging](#) frame, [Severity](#) field.
- Apply the settings temporarily. To do this, click the  button.

When you activate the logging of SNMP requests, the device logs the requests as events in the syslog. The [Log SNMP get request](#) function logs user requests for device configuration information. The [Log SNMP set request](#) function logs device setup events. Specify the minimum level for events that the device logs in the syslog.

Perform the following steps:

- Enable the *Log SNMP get request* function for the device to send SNMP Read requests as events to the syslog server.
To enable the function, select the *On* radio button in the *SNMP logging* frame.
- Enable the *Log SNMP set request* function for the device to send SNMP Write requests as events to the syslog server.
To enable the function, select the *On* radio button in the *SNMP logging* frame.
- Choose the desired severity level for the get and set requests.
- Apply the settings temporarily. To do this, click the  button.

When active, the device logs configuration changes made using the Command Line Interface, to the audit trail. This feature is based on IEEE 1686 for Substation Intelligent Electronic Devices.

Perform the following steps:

- Open the *Diagnostics > Report > Global* dialog.
- To enable the function, select the *On* radio button in the *CLI logging* frame.
- Apply the settings temporarily. To do this, click the  button.

The device lets you save the following system information data in one ZIP file on your PC:

- ▶ audittrail.html
- ▶ config.xml
- ▶ defaultconfig.xml
- ▶ script
- ▶ runningconfig.xml
- ▶ supportinfo.html
- ▶ systeminfo.html
- ▶ systemlog.html

The device names the ZIP archive automatically in the format <IP_address>_<system_name>.zip.

Perform the following steps:



- Click the  button.
After a while, you can download the ZIP archive.
- Select the directory in which you want to save the support information.
- Click the *Ok* button.

13.10.2 Syslog

The device lets you send messages about device internal events to one or more syslog servers (up to 8). Additionally, you also include SNMP requests to the device as events in the syslog.

Note: To display the logged events, open the *Diagnostics > Report > Audit Trail* dialog or the *Diagnostics > Report > System Log* dialog.

Perform the following steps:

- Open the *Diagnostics > Syslog* dialog.
- To add a table row, click the  button.
- In the *IP address* column, enter the IP address of the syslog server. You can specify a valid IPv4 or IPv6 address for the syslog server.
- In the *Destination UDP port* column, specify the UDP port on which the syslog server expects the log entries.
- In the *Min. severity* column, specify the minimum severity level that an event requires for the device to send a log entry to this syslog server.
- Mark the checkbox in the *Active* column.
- To enable the function, select the *On* radio button in the *Operation* frame.
- Apply the settings temporarily. To do this, click the  button.

In the *SNMP logging* frame, set up the following settings for SNMP read and write requests:

Perform the following steps:

- Open the *Diagnostics > Report > Global* dialog.
- Enable the *Log SNMP get request* function for the device to send SNMP Read requests as events to the syslog server. To enable the function, select the *On* radio button in the *SNMP logging* frame.
- Enable the *Log SNMP set request* function for the device to send SNMP Write requests as events to the syslog server. To enable the function, select the *On* radio button in the *SNMP logging* frame.
- Choose the desired severity level for the get and set requests.
- Apply the settings temporarily. To do this, click the  button.

<pre>enable configure logging host add 1 addr 10.0.1.159 severity 3 logging host add 2 addr 2001::1 severity 4 logging syslog operation exit show logging host</pre>	<p>To change to the Privileged EXEC mode.</p> <p>To change to the Configuration mode.</p> <p>To add a recipient in the syslog servers list. The value 3 specifies the severity level of the event that the device logs. The value 3 means error.</p> <p>To add an IPv6 recipient in the syslog servers list. The value 4 means warning.</p> <p>To enable the <i>Syslog</i> function.</p> <p>To change to the Privileged EXEC mode.</p> <p>To display the syslog host settings.</p>
<pre> No. Server IP Port Max. Severity Type Status ----- 1 10.0.1.159 514 error systemlog active 2 2001::1 514 warning systemlog active configure logging snmp-requests get operation logging snmp-requests get severity 5</pre>	<p>To change to the Configuration mode.</p> <p>To log the reception of <i>SNMP Get requests</i>.</p> <p>The value 5 specifies the severity level of the event that the device logs when it receives an <i>SNMP Get request</i>. The value 5 means notice.</p>

logging snmp-requests set operation	To log the reception of <i>SNMP Set requests</i> .
logging snmp-requests set severity 5	The value 5 specifies the severity level of the event that the device logs when it receives an <i>SNMP Set request</i> . The value 5 means <i>notice</i> .
exit	To change to the Privileged EXEC mode.
show logging snmp	To display the SNMP logging settings.
Log SNMP GET requests	: enabled
Log SNMP GET severity	: notice
Log SNMP SET requests	: enabled
Log SNMP SET severity	: notice

13.10.3 System Log

The device lets you call up a System Log file of the system events. The table in the [Diagnostics > Report > System Log](#) dialog lists the logged events.

You have the following options:

- ▶ [View and refresh the System Log file](#)
- ▶ [Searching for content](#)
- ▶ [Downloading a copy of the System Log file](#)
- ▶ [Clearing the System Log file on the device](#)

You have the option to also send the logged events to one or more syslog servers.

View and refresh the System Log file

The device continuously logs events in the System Log file. The display of events in the Graphical User Interface does not update automatically. If the dialog is already open for a while, refresh the display to also display the recently logged events.

Perform the following steps:

- Refresh the display of the System Log file in the Graphical User Interface. To do this, click the  button.

enable	To change to the Privileged EXEC mode.
show logging buffered	To display the buffered log entries.

Searching for content

The device continuously logs events in the System Log file. After a while, the file may contain a large number of events.

Perform the following steps:

- Look for a keyword in the System Log file. To do this, use the search function of your web browser.

```
enable
show logging buffered <filter>
```

To change to the Privileged EXEC mode.

To display the buffered log entries.
You can enter keywords for the severity level, digits, or ranges, separated by a comma.

Example: `emergency,alert-error,4,5-6`

Downloading a copy of the System Log file

The device continuously logs events in the System Log file. After a while, the file may contain many events. In the Graphical User Interface, you can download a copy of the System Log file to analyze the logged events on your computer. Using the Command Line Interface, you can save a copy of the System Log file in the external memory or on a remote server.

Perform the following steps:

- Download a copy of the System Log file onto your computer. To do this, click the  button.
- The web browser saves the file on the computer according to its download settings. If necessary, select the file location.

```
enable
copy eventlog buffered envm EXAMPLE
```

To change to the Privileged EXEC mode.

To save a copy of the System Log file with filename `EXAMPLE` in the external memory.

```
copy eventlog buffered remote ftp://
1.2.3.4/EXAMPLE
```

To save a copy of the System Log file with filename `EXAMPLE` on a remote server.

Clearing the System Log file on the device

The device continuously logs events in the System Log file. After a while, the file may contain many events. If you are no longer interested in the logged events, you can clear the System Log file in the device.

Perform the following steps:

- Delete the content of the System Log file. To do this, click the  button.

	enable	To change to the Privileged EXEC mode.
	clear logging buffered	To clear the log file.

13.10.4 Audit Trail

The *Diagnostics > Report > Audit Trail* dialog contains system information and changes to the device settings performed through the Command Line Interface and SNMP. In the case of a change in the device settings, the dialog displays Who changed What and When.

The *Diagnostics > Syslog* dialog lets you specify up to 8 syslog servers to which the device sends Audit Trails.

The following list contains log events:

- ▶ changes to configuration parameters
- ▶ Commands (except show commands) using the Command Line Interface
- ▶ Command `logging audit-trail <string>` using the Command Line Interface which logs the comment
- ▶ Automatic changes to the System Time
- ▶ watchdog events
- ▶ locking a user after several unsuccessful login attempts
- ▶ User login, either locally or remote, using the Command Line Interface
- ▶ Manual, user-initiated, logout
- ▶ Timed logout after a user-defined period of inactivity in the Command Line Interface
- ▶ File transfer operation including a device software update
- ▶ Configuration changes using HiDiscovery
- ▶ Automatic configuration or device software updates using the external memory
- ▶ Blocked access to the device management due to invalid login
- ▶ Rebooting
- ▶ Opening and closing SNMP over HTTPS tunnels
- ▶ Detected power failures

13.11 Network analysis with TCPdump

Tcpdump is a packet-sniffing UNIX utility used by network administrators to sniff and analyze the data stream on a network. A couple of reasons for sniffing data streams on a network are to verify connectivity between hosts or to analyze the data stream traversing the network.

TCPDump in the device provides the possibility to decode or capture packets received and transmitted by the Management CPU. This function is available using the `debug` command. For further information on the TCPDump function, see the “Command Line Interface” reference manual.

13.12 Monitoring the data stream with Port Mirroring

The *Port Mirroring* function lets you copy data packets from physical source ports to a physical destination port. Port Mirroring is also known as Switched Port Analyzer (SPAN).

You monitor the data packets on the source ports in the sending and receiving directions with a management tool connected on the destination port, for example an *RMON probe*. The function has no effect on the data stream running on the source ports.

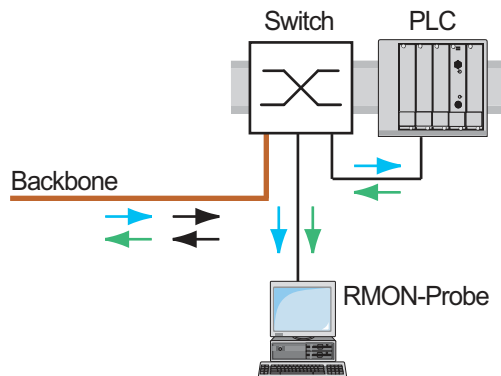

Figure 45: Application example of a port-mirroring setup

On the destination port, the device only forwards the data packets copied from the source ports.

Before you switch on the *Port Mirroring* function, mark the checkbox *Allow management* to access the device management through the destination port. The device lets users access the device management through the destination port without interrupting the active *Port Mirroring* session.

Note: The device duplicates multicasts, broadcasts and unknown unicasts on the destination port.

The VLAN settings on the destination port remain unchanged. Prerequisite for access to the device management on the destination port is that the destination port is a member of the device management VLAN.

13.12.1 Enabling the Port Mirroring function

Perform the following steps:

- Open the *Diagnostics > Ports > Port Mirroring* dialog.
- Specify the source ports.
Mark the checkbox in the *Enabled* column for the relevant ports.
- Specify the destination port.
In the *Destination port* frame, select the desired port from the *Primary port* drop-down list.
The drop-down list only displays available ports. Ports that are already specified as source ports are unavailable.
- To access the device management through the destination port:
In the *Destination port* frame, mark the *Allow management* checkbox.
- Apply the settings temporarily. To do this, click the  button.

To deactivate the *Port Mirroring* function and restore the default settings, click the  button.

13.13 Self-test

The device checks its assets during the system startup and occasionally thereafter. The device checks system task availability or termination and the available amount of memory. Furthermore, the device checks for application functionality and any hardware degradation in the chip set.

If the device detects a loss in integrity, then the device responds to the degradation with a user-defined action. The following categories are available for configuration.

- ▶ [task](#)
Action to be taken in case a task is unsuccessful.
- ▶ [resource](#)
Action to be taken due to the lack of resources.
- ▶ [software](#)
Action taken for loss of software integrity; for example, code segment checksum or access violations.
- ▶ [hardware](#)
Action taken due to hardware degradation

Set up each category to produce an action in case the device detects a loss in integrity. The following actions are available for configuration.

- ▶ [log only](#)
This action writes a message to the logging file.
- ▶ [send trap](#)
Sends an SNMP trap to the trap destination.
- ▶ [reboot](#)
If activated, then a detected error in the category will cause the device to reboot.

Perform the following steps:

- Open the [Diagnostics > System > Selftest](#) dialog.
- In the [Action](#) column, specify the action to perform for a cause.
- Apply the settings temporarily. To do this, click the button.

enable	To change to the Privileged EXEC mode.
configure	To change to the Configuration mode.
selftest action task log-only	To send a message to the event log when a task is unsuccessful.
selftest action resource send-trap	To send an SNMP trap when there are insufficient resources.
selftest action software send-trap	To send an SNMP trap when the software integrity has been lost.
selftest action hardware reboot	To reboot the device when hardware degradation occurs.

Disabling these functions lets you decrease the time required to restart the device after a cold start. You find these options in the [Diagnostics > System > Selftest](#) dialog, [Configuration](#) frame.

- ▶ [RAM test](#) checkbox
Activates/deactivates RAM selftest during a cold start.

- ▶ *SysMon1 is available* checkbox
Activates/deactivates System Monitor 1 during a cold start.
- ▶ *Load default config on error* checkbox
Activates/deactivates the loading of the default device configuration in case no readable configuration is available during the system startup.

The following settings block your access to the device permanently in case the device does not detect any readable configuration profile at system startup.

- ▶ The *SysMon1 is available* checkbox is unmarked.
- ▶ The *Load default config on error* checkbox is unmarked.

This is the case, for example, when the password of the configuration profile that you are loading differs from the password set in the device. To have the device unlocked again, contact your sales partner.

Perform the following steps:

```
selftest ramtest                To activate RAM selftest on cold start.
no selftest ramtest             To deactivate RAM selftest.
selftest system-monitor         To activate System Monitor 1.
no selftest system-monitor      To deactivate System Monitor 1.
show selftest action            To display the actions to be taken in the event of
                                device degradation.

Cause      Action
-----
task       reboot
resource   reboot
software   reboot
hardware   reboot

show selftest settings         To display the selftest settings.

Selftest settings
-----
Test RAM on cold start.....enabled
System Monitor 1.....enabled
Boot default configuration on error.....enabled
```

13.14 Copper cable test

Use this function to check a copper cable attached to a port for a short or open circuit. The test interrupts the data stream, when in progress, on this port.

The table displays the state and lengths of each individual pair. The device returns a result with the following meaning:

- ▶ normal - indicates that the cable is operating properly
- ▶ open - indicates an interruption in the cable
- ▶ short circuit - indicates a short circuit in the cable
- ▶ untested - indicates an untested cable
- ▶ Unknown - cable unplugged

14 Advanced functions of the device

14.1 DHCP server

The Dynamic Host Configuration Protocol (DHCP) lets a server assign the IP settings to the devices on the network (clients). This reduces the effort required for manual setup. The DHCP server stores and assigns the available IP addresses and further settings, if specified.

The procedure for assigning the IP settings consists of 4 phases:

- *DISCOVER* sent by the DHCP client
- *OFFER* sent by the DHCP server
- *REQUEST* sent by the DHCP client
- *ACKNOWLEDGE* sent by the DHCP server

The DHCP server in the device listens for requests on UDP port 67 and responds to the client devices on UDP port 68. When the device receives a DHCP request, it validates the IP address to be assigned before leasing the IP address and other IP settings to the requesting client device.

The device lets you activate the *DHCP Server* function globally or on single physical ports.

14.1.1 Settings that the server assigns to the clients

When operating as a DHCP server, the device assigns the IP settings to the client devices based on the following parameters:

- MAC address of the client device
- Physical port to which the client device is connected
- VLAN of which the client device is a member

The device assigns the following IP settings to the client devices:

- IP address
- Subnet mask
- Default gateway, if specified
- Further network settings, if specified

14.1.2 Pools

The device stores the IP settings in two types of pools.

- Static pools
To assign the same IP address to a specific device each time, the device stores the relevant IP settings in a pool whose address range is exactly one IP address. Static pools are useful, for example, to assign a fixed IP address to a server, NAS, or printer.
- Dynamic pools
To assign IP addresses from a certain address range, the device stores the relevant IP settings in a pool whose address range includes multiple IP addresses. Dynamic pools are useful, for example, to assign a certain IP address to client devices that belong to a certain VLAN.



Setting up a static pool

In the following example, you set up the device to assign IP settings from a certain static pool to a certain client device connected to a certain port.

The static pool is to be set up based on the following parameters:

- ▶ MAC address of the client device: `ec:e5:55:d6:50:01`
- ▶ Physical port to which the client device is connected on the server device: `1/1`
- ▶ IP address that the device should assign to the client device: `192.168.23.42`
- ▶ The assigned IP settings are valid for 2 days: `172800`

Perform the following steps:

- Open the *Advanced > DHCP > DHCP Server > Pool* dialog.
- Add a table row. To do this, click the  button.
- Specify the following settings for the table row:
 - *IP range start* column = `192.168.23.42`
 - *Port* column = `1/1`
 - *MAC address* column = `ec:e5:55:d6:50:01`
 - *Lease time [s]* column = `172800`
 - *Active* column = marked
- Apply the settings temporarily. To do this, click the  button.
- Open the *Advanced > DHCP > DHCP Server > Global* dialog.
- Verify that the DHCP function is active on port `1/1`.
If not already done, mark the checkbox in the *DHCP server active* column for port `1/1`.
- Enable the DHCP server globally. To do this, select the *On* radio button in the *Operation* frame.
- Apply the settings temporarily. To do this, click the  button.

<code>enable</code>	To change to the Privileged EXEC mode.
<code>configure</code>	To change to the Configuration mode.
<code>dhcp-server pool add 1 static 192.168.23.42</code>	To add a static pool with index <code>1</code> with the IP address <code>192.168.23.42</code> .
<code>dhcp-server pool modify 1 mode interface 1/1</code>	To assign the static pool with index <code>1</code> to physical port <code>1/1</code> .
<code>dhcp-server pool modify 1 mode mac EC:E5:55:D6:50:01</code>	To assign the static pool with index <code>1</code> to a client device with MAC address <code>EC:E5:55:D6:50:01</code> .
<code>dhcp-server pool modify 1 leasetime 172800</code>	To specify the lease time of the static pool with index <code>1</code> .
<code>dhcp-server pool mode 1 enable</code>	To enable the static pool with index <code>1</code> .
<code>dhcp-server operation</code>	To enable the DHCP server globally.
<code>interface 1/1</code>	To change to the interface configuration mode of port <code>1/1</code> .
<code>dhcp-server operation</code>	To activate the DHCP server function on this port.



Setting up a dynamic pool

In the following example, you set up the device to assign an IP address from a certain address range to client devices connected to a certain port.

The dynamic pool is to be set up based on the following parameters:

- ▶ MAC address of the client device or further information in the DHCP request is not to be evaluated.
- ▶ Physical port to which the client devices are connected on the server device: [1/2](#)
- ▶ Address range from which the device assigns an IP address to the client devices: [192.168.23.92..192.168.23.142](#)
- ▶ The assigned IP settings are valid for 2 days: [172800](#)

Perform the following steps:

- Open the [Advanced > DHCP > DHCP Server > Pool](#) dialog.
- Add a table row. To do this, click the  button.
- Specify the following settings for the table row:
 - [IP range start](#) column = [192.168.23.92](#)
 - [IP range end](#) column = [192.168.23.142](#)
 - [Port](#) column = [1/2](#)
 - [Lease time \[s\]](#) column = [172800](#)
 - [Active](#) column = [Marked](#)
- Apply the settings temporarily. To do this, click the  button.
- Open the [Advanced > DHCP > DHCP Server > Global](#) dialog.
- Verify that the DHCP function is active on port [1/2](#).
If not already done, mark the checkbox in the [DHCP server active](#) column for port [1/2](#).
- Enable the DHCP server globally. To do this, select the [On](#) radio button in the [Operation](#) frame.
- Apply the settings temporarily. To do this, click the  button.

enable	To change to the Privileged EXEC mode.
configure	To change to the Configuration mode.
dhcp-server pool add 2 dynamic 192.168.23.92 192.168.23.142	To add a dynamic pool with index 2 with a range from 192.168.23.92 to 192.168.23.142 .
dhcp-server pool modify 2 mode interface 1/ 2	To assign the static pool with index 2 to physical port 1/2 .
dhcp-server pool modify 2 leasetime 172800	To specify the lease time of the dynamic pool with index 2 .
dhcp-server pool mode 2 enable	To enable the dynamic pool with index 2 .
dhcp-server operation	To enable the DHCP server globally.
interface 1/2	To change to the interface configuration mode of port 1/2 .
dhcp-server operation	To activate the DHCP server function on this port.

14.2 DHCP L2 Relay

A network administrator uses the DHCP Layer 2 *Relay Agent* to add DHCP client information. This information is required by Layer 3 *Relay Agents* and DHCP servers to assign an address and configuration to a client.

When a DHCP client and server are in the same IP subnet, they exchange IP address requests and replies directly. However, having a DHCP server on each subnet is expensive and often impractical. An alternative to having a DHCP server in every subnet is to use the network devices to relay packets between a DHCP client and a DHCP server located in a different subnet.

A Layer 3 *Relay Agent* is generally a router that has IP interfaces in both the client and server subnets and routes the data packets between them. However, in Layer 2 switched networks, there are one or more network devices, switches for example, between the client and the Layer 3 *Relay Agent* or DHCP server. In this case, this device provides a Layer 2 *Relay Agent* to add the information that the Layer 3 *Relay Agent* and DHCP server require to perform their roles in address and configuration assignment.

For the DHCPv6 protocol, a *Relay Agent* is used to add *Relay Agent* options to DHCPv6 packets exchanged between a client and a DHCPv6 server. The Lightweight DHCPv6 Relay Agent (LDRA) is described in RFC 6221.

The LDRA processes 2 types of messages:

- ▶ The first type of message is the *Relay-Forward* message which contains unique information about the client.
- ▶ The second type of message is the *Relay-Reply* message which the DHCPv6 server sends to the *Relay Agent*. The *Relay Agent* then validates the message to include the information encapsulated in the initial *Relay-Forward* message and if valid, sends the packet to the client.

The *Relay-Forward* message contains *Interface-ID* information, also known as *Option 18*. This option provides information that identifies the interface on which the client request was sent. The device discards DHCPv6 packets that do not contain *Option 18* information.

14.2.1 Circuit and Remote IDs

In an IPv4 environment, before forwarding the request of a client to the DHCP server, the device adds the *Circuit ID* and the *Remote ID* to the *Option 82* field of the DHCP request packet.

- ▶ The *Circuit ID* stores on which port the device received the request of the client.
- ▶ The *Remote ID* contains the MAC address, the IP address, the system name, or a user-defined character string. Using it, the participating devices identify the *Relay Agent* that received the request of the client.

The device and other *Relay Agents* use this information to re-direct the answer from the DHCP *Relay Agent* to the original client. The DHCP server is able to analyze this data for example to assign the client an IP address from a specific address pool.

Also, the replay packet of the DHCP server contains the *Circuit ID* and the *Remote ID*. Before forwarding the answer to the client, the device removes the information from the *Option 82* field.

14.2.2 DHCP L2 Relay configuration

The *Advanced > DHCP L2 Relay > Configuration* dialog lets you activate the function on the active ports and on the VLANs. In the *Operation* frame, select the *On* radio button. Then click the button.

The device forwards DHCPv4 packets with *Option 82* information and DHCPv6 packets with *Option 18* information on those ports for which the checkbox in the *Active* column and in the *Trusted port* column is marked. Typically, these are ports in the network of the DHCP server.

The ports to which the DHCP clients are connected, you activate the *DHCP L2 Relay* function, but leave the *Trusted port* checkbox unmarked. On these ports, the device discards DHCPv4 packets with *Option 82* information and DHCPv6 packets with *Option 18* information.

An example configuration for the DHCPv4 L2 Relay function is shown below. The configuration steps for DHCPv6 L2 Relay function are similar, except for the *Circuit ID* and *Remote ID* entries that can only be specified for *Option 82*.

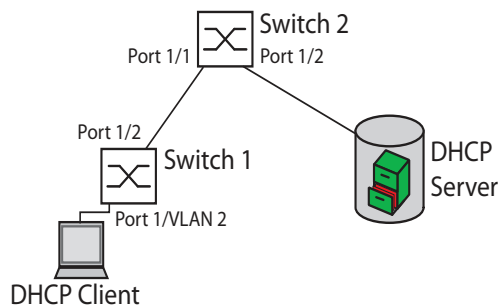

Figure 46: DHCP Layer 2 Example Network

Perform the following steps on Switch 1:

- Open the *Advanced > DHCP L2 Relay > Configuration* dialog, *Interface* tab.
- For port *1/1*, specify the settings as follows:
 - Mark the checkbox in the *Active* column.
- For port *1/2*, specify the settings as follows:
 - Mark the checkbox in the *Active* column.
 - Mark the checkbox in the *Trusted port* column.
- Open the *Advanced > DHCP L2 Relay > Configuration* dialog, *VLAN ID* tab.
- Specify the settings for VLAN 2 as follows:
 - Mark the checkbox in the *Active* column.
 - Mark the checkbox in the *Circuit ID* column.
 - To use the IP address of the device as the *Remote ID*, in the *Remote ID type* column, specify the value *ip*.
- To enable the function, select the *On* radio button in the *Operation* frame.
- Apply the settings temporarily. To do this, click the button.

Perform the following steps on Switch 2:

- Open the *Advanced > DHCP L2 Relay > Configuration* dialog, *Interface* tab.
- For port *1/1* and *1/2*, specify the settings as follows:
 - Mark the checkbox in the *Active* column.
 - Mark the checkbox in the *Trusted port* column.
- To enable the function, select the *On* radio button in the *Operation* frame.
- Apply the settings temporarily. To do this, click the button.

Verify that VLAN 2 is present. Then perform the following steps on Switch 1:

- Set up VLAN 2, and specify port *1/1* as a member of VLAN 2.

enable	To change to the Privileged EXEC mode.
vlan database	To change to the VLAN configuration mode.
dhcp-l2relay circuit-id 2	To activate the Circuit ID and the DHCP Option 82 on VLAN 2.
dhcp-l2relay remote-id ip 2	To specify the IP address of the device as the Remote ID on VLAN 2.
dhcp-l2relay mode 2	To activate the <i>DHCP L2 Relay</i> function on VLAN 2.
exit	To change to the Privileged EXEC mode.
configure	To change to the Configuration mode.
interface 1/1	To change to the interface configuration mode of interface <i>1/1</i> .
dhcp-l2relay mode	To activate the <i>DHCP L2 Relay</i> function on the port.
exit	To change to the Configuration mode.
interface 1/2	To change to the interface configuration mode of interface <i>1/2</i> .
dhcp-l2relay trust	To specify the port as <i>Trusted port</i> .
dhcp-l2relay mode	To activate the <i>DHCP L2 Relay</i> function on the port.
exit	To change to the Configuration mode.
dhcp-l2relay mode	To enable the <i>DHCP L2 Relay</i> function in the device.

Perform the following steps on Switch 2:

enable	To change to the Privileged EXEC mode.
configure	To change to the Configuration mode.
interface 1/1	To change to the interface configuration mode of interface <i>1/1</i> .
dhcp-l2relay trust	To specify the port as <i>Trusted port</i> .
dhcp-l2relay mode	To activate the <i>DHCP L2 Relay</i> function on the port.
exit	To change to the Configuration mode.
interface 1/2	To change to the interface configuration mode of interface <i>1/2</i> .
dhcp-l2relay trust	To specify the port as <i>Trusted port</i> .
dhcp-l2relay mode	To activate the <i>DHCP L2 Relay</i> function on the port.
exit	To change to the Configuration mode.
dhcp-l2relay mode	To enable the <i>DHCP L2 Relay</i> function in the device.

14.3 MRP-IEEE

The IEEE 802.1ak amendment to the IEEE 802.1Q standard introduced the Multiple Registration Protocol (MRP) to replace the Generic Attribute Registration Protocol (GARP). The IEEE standards association also modified and replaced the *GARP* applications, GARP Multicast Registration Protocol (GMRP) and GARP VLAN Registration Protocol (GVRP), with the Multiple MAC Registration Protocol (MMRP) and the Multiple VLAN Registration Protocol (MVRP).

To confine forwarding the data packets to the required areas of a network, the MRP applications distribute attribute values to MRP enabled devices across a LAN. The MRP applications register and de-register Multicast group memberships and VLAN identifiers.

Note: The Multiple Registration Protocol (MRP) requires a loop free network. To help prevent loops in the network, use a network protocol such as the Media Redundancy Protocol, Spanning Tree Protocol, or Rapid Spanning Tree Protocol with MRP.

14.3.1 MRP operation

Each participant contains an applicant component and an MRP Attribute Declaration (MAD) component. The applicant component is responsible for forming the attribute values and their registration and de-registration. The MAD component generates MRP messages for transmission and processes messages received from other participants. The MAD component encodes and transmits the attributes to other participants in MRP Data Units (MRPDU). In the switch, an MRP Attribute Propagation (MAP) component distributes the attributes to participating ports.

A participant exists for each MRP application and each LAN port. For example, a participant application exists on an end device and another application exists on a switch port. The Applicant state machine records the attribute and port for each MRP participant declaration on an end device or switch. Applicant state machine variable changes trigger the transmission of MRPDUs to communicate the declaration or withdrawal.

To establish an *MMRP* instance, an end device first sends a Join empty (JoinMt) message with the appropriate attributes. The switch then floods the JoinMt to the participating ports and to the neighboring switches. The neighboring switches flood the message to their participating port, and so on, establishing a path for the group data packets.

14.3.2 MRP timers

The default timer settings help prevent unnecessary attribute declarations and withdraws. The timer settings allow the participants to receive and process MRP messages before the Leave or LeaveAll timers expire.

When you reconfigure the timers, maintain the following relationships:

- ▶ To allow for re-registration after a Leave or LeaveAll event, although there is a lost message, set the value of the LeaveTime as follows: $\geq (2x \text{JoinTime}) + 60$ in 1/100 s
- ▶ To minimize the volume of rejoining data packets generated following a LeaveAll event, specify the value for the LeaveAll timer larger than the LeaveTime value.

The following list contains various MRP events that the device transmits:

- ▶ Join - Controls the interval for the next Join message transmission
- ▶ Leave - Controls the length of time that a switch waits in the Leave state before changing to the withdraw state
- ▶ LeaveAll - Controls the frequency with which the switch generates LeaveAll messages

When expired, the Periodic timer initiates a Join request MRP message that the switch sends to participants on the LAN. The switches use this message to help prevent unnecessary withdraws.

14.3.3 MMRP

When a device receives Broadcast, Multicast or unknown data packets on a port, the device floods the data packets to the other ports. This process causes unnecessary use of bandwidth on the LAN.

The Multiple MAC Registration Protocol (MMRP) lets you control the data packets flooding by distributing an attribute declaration to participants on a LAN. The attribute values that the MAD component encodes and transmits on the LAN in MRP messages are Group service requirement information and 48-bit MAC addresses.

The switch stores the attributes in a filtering database as MAC address registration entries. The forwarding process uses the filtering database entries only to transmit data through those ports necessary to reach Group member LANs.

Switches facilitate the group distribution mechanisms based on the Open Host Group concept, receiving packets on the active ports and forwarding only to ports with group members. This way, any *MMRP* participants requiring packets transmitted to a particular group or groups, requests membership in the group. MAC service users send packets to a particular group from anywhere on the LAN. A group receives these packets on the LANs attached to registered *MMRP* participants. *MMRP* and the MAC Address Registration Entries thus restrict the packets to required segments of a loop-free LAN.

To maintain the registration and deregistration state and to receive data packets, a port declares interest periodically. Every device on a LAN with the *MMRP* function enabled maintains a filtering database and forwards the data packets with the group MAC addresses to the listed participants.

Setting up MMRP

In this example, Host A intends to listen to the data packets destined for group G1. Switch A processes the *MMRP* Join request received from host A and sends the request to both of the neighboring switches. The devices on the LAN now recognize that there is a host interested in receiving the data packets destined for group G1. When Host B starts transmitting data destined for group G1, the data flows on the path of registrations and Host A receives it.

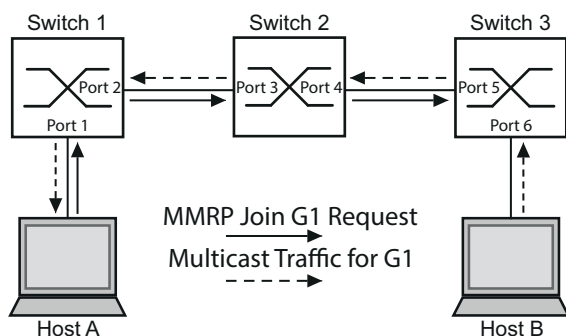

Figure 47: *MMRP* Network for MAC address Registration

Enable the *MMRP* function on the switches. To do this, perform the following steps:

- Open the *Switching > MRP-IEEE > MMRP* dialog, *Configuration* tab.
- To activate port 1 and port 2 as *MMRP* participants, mark the checkbox in the *MMRP* column for port 1 and port 2 on switch 1.
- To activate port 3 and port 4 as *MMRP* participants, mark the checkbox in the *MMRP* column for port 3 and port 4 on switch 2.
- To activate port 5 and port 6 as *MMRP* participants, mark the checkbox in the *MMRP* column for port 5 and port 6 on switch 3.
- To send periodic events allowing the device to maintain the registration of the MAC address group, enable the *Periodic state machine*. Select the *On* radio button in the *Configuration* frame.
- Apply the settings temporarily. To do this, click the button.

To enable the *MMRP* ports on switch 1, use the following commands. Substituting the appropriate interfaces in the commands, enable the *MMRP* functions and ports on switches 2 and 3.

enable	To change to the Privileged EXEC mode.
configure	To change to the Configuration mode.
interface 1/1	To change to the interface configuration mode of interface 1/1.
mrp-ieee mmrp operation	To enable the <i>MMRP</i> function on the port.
interface 1/2	To change to the interface configuration mode of interface 1/2.
mrp-ieee mmrp operation	To enable the <i>MMRP</i> function on the port.
exit	To change to the Configuration mode.
mrp-ieee mrp periodic-state-machine	To enable the <i>Periodic state machine</i> function globally.
mrp-ieee mmrp operation	To enable the <i>MMRP</i> function globally.

14.3.4 MVRP

The Multiple VLAN Registration Protocol (MVRP) is an MRP application that provides dynamic VLAN registration and withdraw services on a LAN.

The *MVRP* function provides a maintenance mechanism for the Dynamic VLAN Registration Entries, and for transmitting the information to other devices. This information lets *MVRP*-aware devices establish and update their VLAN membership information. When members are present on a VLAN, the information indicates through which ports the switch forwards the data packets to reach those members.

The main purpose of the *MVRP* function is to allow switches to discover some of the VLAN information that you otherwise manually set up. Discovering this information lets switches overcome the limitations of bandwidth consumption and convergence time in large VLAN networks.

MVRP example

Set up a network comprised of MVRP aware switches (1-4) connected in a ring topology with end device groups, A1, A2, B1, and B2 in 2 different VLANs, A and B. With STP enabled on the switches, the ports connecting switch 1 to switch 4 are in the *discarding* state, helping prevent a loop condition.

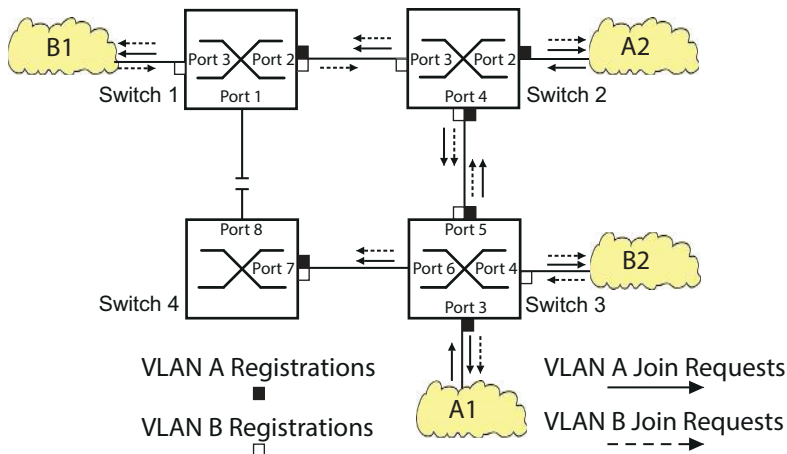

Figure 48: MVRP Example Network for VLAN Registration

In the MVRP example network, the LANs first send a Join request to the switches. The switch enters the VLAN registration in the MAC address table (forwarding database) for the port receiving the frames.

The switch then propagates the request to the other ports, and sends the request to the neighboring LANs and switches. This process continues until the switches have registered the VLANs in the MAC address table (forwarding database) of the receive port.

Enable MVRP on the switches. To do this, perform the following steps:

- Open the [Switching > MRP-IEEE > MVRP](#) dialog, [Configuration](#) tab.
- To activate the ports 1 through 3 as [MVRP](#) participants, mark the checkbox in the [MVRP](#) column for the ports 1 through 3 on switch 1.
- To activate the ports 2 through 4 as [MVRP](#) participants, mark the checkbox in the [MVRP](#) column for the ports 2 through 4 on switch 2.
- To activate the ports 3 through 6 as [MVRP](#) participants, mark the checkbox in the [MVRP](#) column for the ports 3 through 6 on switch 3.
- To activate port 7 and port 8 as [MVRP](#) participants, mark the checkbox in the [MVRP](#) column for port 7 and port 8 on switch 4.
- To maintain the registration of the VLANs, enable the [Periodic state machine](#). Select the [On](#) radio button in the [Configuration](#) frame.
- To enable the function, select the [On](#) radio button in the [Operation](#) frame.
- Apply the settings temporarily. To do this, click the button.

To enable the *MVRP* ports on switch 1, use the following commands. Substituting the appropriate interfaces in the commands, enable the *MVRP* functions and ports on switches 2, 3 and 4.

```
enable
configure
interface 1/1

mrp-ieee mvrp operation
interface 1/2

mrp-ieee mvrp operation
exit

mrp-ieee mvrp periodic-state-machine

mrp-ieee mvrp operation
```

To change to the Privileged EXEC mode.

To change to the Configuration mode.

To change to the interface configuration mode of interface *1/1*.

To enable the *MVRP* function on the port.

To change to the interface configuration mode of interface *1/2*.

To enable the *MVRP* function on the port.

To change to the Configuration mode.

To enable the *Periodic state machine* function globally.

To enable the *MVRP* function globally.

15 Industry Protocols

For a long time, automation communication and office communication were on different paths. The requirements and the communication properties were too different.

Office communication moves large quantities of data with low demands with respect to the transfer time. Automation communication moves small quantities of data with high demands with respect to the transfer time and availability.

While the transmission devices in the office are usually kept in temperature-controlled, relatively clean rooms, the transmission devices used in automation are exposed to wider temperature ranges. Dirty, dusty and damp ambient conditions make additional demands on the quality of the transmission devices.

With the continued development of communication technology, the demands and the communication properties have moved closer together. The high bandwidths now available in Ethernet technology and the protocols they support enable large quantities to be transferred and exact transfer times to be specified.

With the first active optical LAN worldwide at the University of Stuttgart in 1984, Hirschmann laid the foundation for industry-compatible office communication devices. Thanks to Hirschmann's initiative with the world's first rail hub in the 1990s, Ethernet transmission devices such as switches, routers and firewalls are now available for the toughest automation conditions.

The desire for uniform, continuous communication structures encouraged many manufacturers of automation devices to come together and use standards to aid the progress of communication technology in the automation sector. This is why we now have protocols that let us communicate through Ethernet from the office right down to the field level.

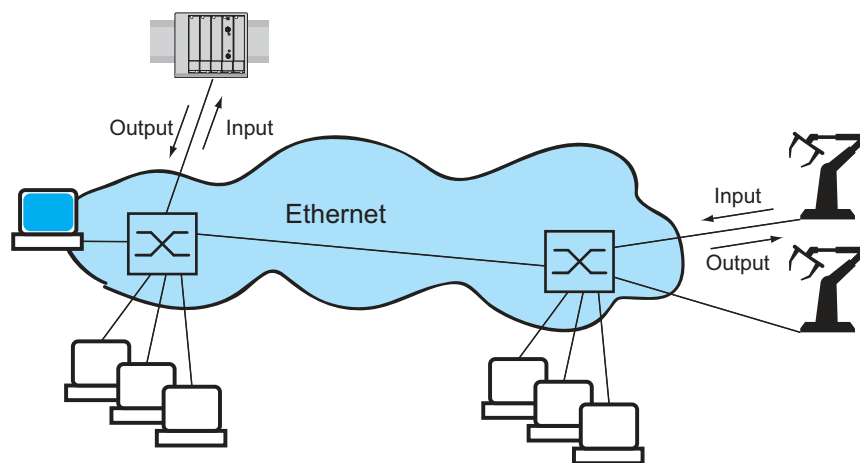

Figure 49: Example of communication.

15.1 Modbus TCP function

Modbus TCP is an application layer messaging protocol providing client/server communication between the client and devices connected in Ethernet TCP/IP networks.

The *Modbus TCP* function lets you install the device in networks already using *Modbus TCP* and retrieve information saved in the registers in the device.

15.1.1 Client/Server Modbus TCP/IP Mode

The device supports the client/server model of Modbus TCP/IP. This device operates as a server in this constellation and responds to requests from a client for information saved in the registers.

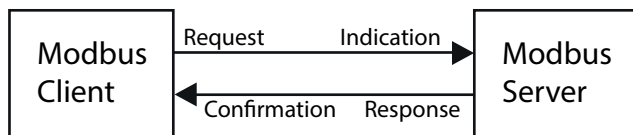

Figure 50: Client/Server Modbus TCP/IP Mode

The client / server model uses four types of messages to exchange data between the client and server:

- ▶ Modbus TCP/IP Request, the client generates a request for information and sends it to the server.
- ▶ Modbus TCP/IP Indication, the server receives a request as an indication that a client requires information.
- ▶ Modbus TCP/IP Response, when the required information is available, the server sends a reply containing the requested information. When the requested information is unavailable, the server sends an Exception Response to notify the client of the error detected during the processing. The Exception Response contains an exception code indicating the reason for the detected error.
- ▶ Modbus TCP/IP Confirmation, the client receives a response from the server, containing the requested information.

15.1.2 Supported Functions and Memory Mapping

The device supports functions with the public codes [0x03 \(Read Holding Registers\)](#) and [0x05 \(Write Single Coil\)](#). The codes let you read the information saved in the registers such as the system information, including the system name, system location, software version, IP address, MAC address. The codes also let you read the port information and port statistics. The [0x05](#) code lets you reset the port counters individually or globally.

The following list contains definitions for the values entered in the [Format](#) column:

- ▶ Bitmap: a group of 32-bits, encoded into the Big-endian byte order and saved in 2 registers. Big-endian systems save the most significant byte of a word in the smallest address and save the least significant byte in the largest address.
- ▶ F1: 16-bit unsigned integer
- ▶ F2: Enumeration - power supply alarm
 - 0 = power supply good
 - 1 = power supply failure detected
- ▶ F3: Enumeration - OFF/ON
 - 0 = Off
 - 1 = On
- ▶ F4: Enumeration - port type
 - 0 = Giga - Gigabit Interface Converter (GBIC)
 - 1 = Copper - Twisted-Pair (TP)
 - 2 = Fiber - 10 Mbit/s
 - 3 = Fiber - 100 Mbit/s
 - 4 = Giga - 10/100/1000 Mbit/s (triple speed)
 - 5 = Giga - Copper 1000 Mbit/s TP
 - 6 = Giga - Small Form-factor Pluggable (SFP)
- ▶ F9: 32-bit unsigned long
- ▶ String: octets, saved in sequence, 2 octets per register.

Modbus TCP/IP Codes

The addresses in the following tables allow the client to reset port counters and retrieve specific information from the device registers.

Table 39: System/Global Information

Address	Qty	Description	Min	Max	Step	Unit	Format
0000	128	System Name	-	-	-	-	String
0080	128	System Contact	-	-	-	-	String
0100	128	System Location	-	-	-	-	String
0180	128	Software Version	-	-	-	-	String
0200	32	OrderCode	-	-	-	-	String
0220	16	Serial Number	-	-	-	-	String
0230	1	IP Address[0]	0	254	1	-	F1
0231	1	IP Address[1]	0	254	1	-	F1
0232	1	IP Address[2]	0	254	1	-	F1
0233	1	IP Address[3]	0	254	1	-	F1
0234	1	NetMask[0]	0	255	1	-	F1
0235	1	NetMask[1]	0	255	1	-	F1
0236	1	NetMask[2]	0	255	1	-	F1
0237	1	NetMask[3]	0	255	1	-	F1
0238	1	GateWay[0]	0	254	1	-	F1
0239	1	GateWay[1]	0	254	1	-	F1
023A	1	GateWay[2]	0	254	1	-	F1
023B	1	GateWay[3]	0	254	1	-	F1
023C	3	MacAddress	-	-	-	-	String
023F	1	PowerAlarm1	0	1	1	-	F2
0240	1	PowerAlarm2	0	1	1	-	F2
0241	1	StpState	0	1	1	-	F1
0242	2	Number of Ports	1	64	1	-	F1
0244	1	Reset Counter (all Counter)	0	1	1	-	F1
0245	4	Port Present Map	-	-	-	-	Bitmap
0249	4	Port Link Map	-	-	-	-	Bitmap
024D	4	Port Stp State Map	-	-	-	-	Bitmap
0251	4	Port Activity Map	-	-	-	-	Bitmap

Table 40: Port Information

Address	Qty	Description	Min	Max	Step	Unit	Format
0400	1	Port 1 Type	0	6	1	-	F4
0401	1	Port 2 Type	0	6	1	-	F4
		...					
043F	1	Port 64 Type	0	6	1	-	F4
0440	1	Port 1 Link Status	0	1	1	-	F1
0441	1	Port 2 Link Status	0	1	1	-	F1
		...					
047F	1	Port 64 Link Status	0	1	1	-	F1
0480	1	Port 1 STP State	0	1	1	-	F1
0481	1	Port 2 STP State	0	1	1	-	F1
		...					
04BF	1	Port 64 STP State	0	1	1	-	F1
04C0	1	Port 1 Activity	0	1	1	-	F1

Table 40: Port Information (cont.)

Address	Qty	Description	Min	Max	Step	Unit	Format
04C1	1	Port 2 Activity	0	1	1	-	F1
		...					
04FF	1	Port 64 Activity	0	1	1	-	F1
0500	1	Port 1 Counter Reset	0	1	1	-	F1
0501	1	Port 2 Counter Reset	0	1	1	-	F1
		...					
053F	1	Port 64 Counter Reset	0	1	1	-	F1

Table 41: Port Statistics

Address	Qty	Description	Min	Max	Step	Unit	Format
0800	2	Port1 - Number of bytes received	0	4294967295 ($2^{32}-1$)	1	-	F9
0802	2	Port1 - Number of bytes sent	0	4294967295	1	-	F9
0804	2	Port1 - Number of frames received	0	4294967295	1	-	F9
0806	2	Port1 - Number of frames sent	0	4294967295	1	-	F9
0808	2	Port1 - Total bytes received	0	4294967295	1	-	F9
080A	2	Port1 - Total frames received	0	4294967295	1	-	F9
080C	2	Port1 - Number of broadcast frames received	0	4294967295	1	-	F9
080E	2	Port1 - Number of multicast frames received	0	4294967295	1	-	F9
0810	2	Port1 - Number of frames with CRC error	0	4294967295	1	-	F9
0812	2	Port1 - Number of oversized frames received	0	4294967295	1	-	F9
0814	2	Port1 - Number of bad fragments rcvd(<64 bytes)	0	4294967295	1	-	F9
0816	2	Port1 - Number of jabber frames received	0	4294967295	1	-	F9
0818	2	Port1 - Number of collisions occurred	0	4294967295	1	-	F9
081A	2	Port1 - Number of late collisions occurred	0	4294967295	1	-	F9
081C	2	Port1 - Number of 64-byte frames rcvd/sent	0	4294967295	1	-	F9
081E	2	Port1 - Number of 65-127 byte frames rcvd/sent	0	4294967295	1	-	F9
0820	2	Port1 - Number of 128-255 byte frames rcvd/sent	0	4294967295	1	-	F9
0822	2	Port1 - Number of 256-511 byte frames rcvd/sent	0	4294967295	1	-	F9
0824	2	Port1 - Number of 512-1023 byte frames rcvd/sent	0	4294967295	1	-	F9
0826	2	Port1 - Number of 1023-MAX byte frames rcvd/sent	0	4294967295	1	-	F9
0828	2	Port1 - Number of Mac Error Packets	0	4294967295	1	-	F9
082A	2	Port1 - Number of dropped received packets	0	4294967295	1	-	F9
082C	2	Port1 - Number of multicast frames sent	0	4294967295	1	-	F9
082E	2	Port1 - Number of broadcast frames sent	0	4294967295	1	-	F9
0830	2	Port1 - Number of <64 byte fragments w/ good CRC	0	4294967295	1	-	F9
0832	2	Port2 - Number of bytes received	0	4294967295	1	-	F9
0834	2	Port2 - Number of bytes sent	0	4294967295	1	-	F9
0836	2	Port2 - Number of frames received	0	4294967295	1	-	F9

Table 41: Port Statistics (cont.)

Address	Qty	Description	Min	Max	Step	Unit	Format
0838	2	Port2 - Number of frames sent	0	4294967295	1	-	F9
083A	2	Port2 - Total bytes received	0	4294967295	1	-	F9
083C	2	Port2 - Total frames received	0	4294967295	1	-	F9
083E	2	Port2 - Number of broadcast frames received	0	4294967295	1	-	F9
0840	2	Port2 - Number of multicast frames received	0	4294967295	1	-	F9
0842	2	Port2 - Number of frames with CRC error	0	4294967295	1	-	F9
0844	2	Port2 - Number of oversized frames received	0	4294967295	1	-	F9
0846	2	Port2 - Number of bad fragments rcvd(<64 bytes)	0	4294967295	1	-	F9
0848	2	Port2 - Number of jabber frames received	0	4294967295	1	-	F9
084A	2	Port2 - Number of collisions occurred	0	4294967295	1	-	F9
084C	2	Port2 - Number of late collisions occurred	0	4294967295	1	-	F9
084E	2	Port2 - Number of 64-byte frames rcvd/sent	0	4294967295	1	-	F9
0850	2	Port2 - Number of 65-127 byte frames rcvd/sent	0	4294967295	1	-	F9
0852	2	Port2 - Number of 128-255 byte frames rcvd/sent	0	4294967295	1	-	F9
0854	2	Port2 - Number of 256-511 byte frames rcvd/sent	0	4294967295	1	-	F9
0856	2	Port2 - Number of 512-1023 byte frames rcvd/sent	0	4294967295	1	-	F9
0858	2	Port2 - Number of 1023-MAX byte frames rcvd/sent	0	4294967295	1	-	F9
085A	2	Port2 - Number of Mac Error Packets	0	4294967295	1	-	F9
085C	2	Port2 - Number of dropped received packets	0	4294967295	1	-	F9
085E	2	Port2 - Number of multicast frames sent	0	4294967295	1	-	F9
0860	2	Port2 - Number of broadcast frames sent	0	4294967295	1	-	F9
0862	2	Port2 - Number of <64 byte fragments w/ good CRC	0	4294967295	1	-	F9
		...					
144E	2	Port64 - Number of bytes received	0	4294967295	1	-	F9
1450	2	Port64 - Number of bytes sent	0	4294967295	1	-	F9
1452	2	Port64 - Number of frames received	0	4294967295	1	-	F9
1454	2	Port64 - Number of frames sent	0	4294967295	1	-	F9
1456	2	Port64 - Total bytes received	0	4294967295	1	-	F9
1458	2	Port64 - Total frames received	0	4294967295	1	-	F9
145A	2	Port64 - Number of broadcast frames received	0	4294967295	1	-	F9
145C	2	Port64 - Number of multicast frames received	0	4294967295	1	-	F9
145E	2	Port64 - Number of frames with CRC error	0	4294967295	1	-	F9
1460	2	Port64 - Number of oversized frames received	0	4294967295	1	-	F9
1462	2	Port64 - Number of bad fragments rcvd(<64 bytes)	0	4294967295	1	-	F9
1464	2	Port64 - Number of jabber frames received	0	4294967295	1	-	F9

Table 41: Port Statistics (cont.)

Address	Qty	Description	Min	Max	Step	Unit	Format
1466	2	Port64 - Number of collisions occurred	0	4294967295	1	-	F9
1468	2	Port64 - Number of late collisions occurred	0	4294967295	1	-	F9
146A	2	Port64 - Number of 64-byte frames rcvd/sent	0	4294967295	1	-	F9
146C	2	Port64 - Number of 65-127 byte frames rcvd/sent	0	4294967295	1	-	F9
146E	2	Port64 - Number of 128-255 byte frames rcvd/sent	0	4294967295	1	-	F9
1470	2	Port64 - Number of 256-511 byte frames rcvd/sent	0	4294967295	1	-	F9
1472	2	Port64 - Number of 512-1023 byte frames rcvd/sent	0	4294967295	1	-	F9
1474	2	Port64 - Number of 1023-MAX byte frames rcvd/sent	0	4294967295	1	-	F9
1476	2	Port64 - Number of Mac Error Packets	0	4294967295	1	-	F9
1478	2	Port64 - Number of dropped received packets	0	4294967295	1	-	F9
147A	2	Port64 - Number of multicast frames sent	0	4294967295	1	-	F9
147C	2	Port64 - Number of broadcast frames sent	0	4294967295	1	-	F9
147E	2	Port64 - Number of <64 byte fragments w/ good CRC	0	4294967295	1	-	F9

15.1.3 Application example for the Modbus TCP function

In the following example, you set up the device to respond to client requests. The prerequisite for this configuration is that the client device is set up with an IP address within the given range. The [Write access](#) function remains inactive for this example. When you activate the [Write access](#) function, the device lets you reset the port counters only. In the default setting the [Modbus TCP](#) and [Write access](#) functions are inactive.

The [Modbus TCP](#) function does not provide any authentication mechanisms. If the write access for [Modbus TCP](#) is activated, then every client that can access the device using TCP/IP is capable of changing the settings of the device. As a result, incorrect device settings and potential network interruptions may occur.

NOTICE
RISK OF UNAUTHORIZED ACCESS TO THE DEVICE
Only activate the write access if you have taken additional measures (for example Firewall, VPN, etc.) to reduce possible unauthorized access.
Failure to follow these instructions can result in equipment damage.

Perform the following steps:

- Open the *Device Security > Management Access > IP Access Restriction* dialog.
- Add a table row. To do this, click the  button.
- Specify the IP address range in the table row where the *Index* column has the value 2. To do this, enter the following values:
 - In the *Address* column: `10.17.1.0`
 - In the *Netmask* column: `255.255.255.248`
- Verify that the checkbox in the *Modbus TCP* column is marked.
- Activate the IP address range. To do this, mark the checkbox in the *Active* column.
- Apply the settings temporarily. To do this, click the  button.
- Open the *Diagnostics > Status Configuration > Security Status* dialog, *Global* tab.
- Verify that the checkbox related to the parameter *Modbus TCP active* is marked.
- Open the *Advanced > Industrial Protocols > Modbus TCP* dialog.
- The standard *Modbus TCP* listening port, port `502`, is the default setting. However, when you wish to listen on another TCP port, enter the value for the listening port in the *TCP port* field.
- To enable the function, select the *On* radio button in the *Operation* frame.
- Apply the settings temporarily. To do this, click the  button.

When you enable the *Modbus TCP* function, the *Security Status* function detects the activation and displays an alarm in the *Basic Settings > System* dialog, *Security status* frame.

enable	To change to the Privileged EXEC mode.
network management access add 2	To add the entry for the address range in the network. Number of the next available index in this example: 2.
network management access modify 2 ip 10.17.1.0	To specify the IP address.
network management access modify 2 mask 29	To specify the netmask.
network management access modify 2 modbus- tcp enable	To specify that the device lets <i>Modbus TCP</i> have access to the device management.
network management access operation configure	To enable the IP access restriction. To change to the Configuration mode.
security-status monitor modbus-tcp-enabled	To specify that the device monitors the activation of the <i>Modbus TCP</i> server.
modbus-tcp operation	To enable the <i>Modbus TCP</i> server.
modbus-tcp port <1..65535>	To specify the TCP port for <i>Modbus TCP</i> communication (optionally). The default setting is port <code>502</code> .
show modbus-tcp	To display the <i>Modbus TCP</i> Server settings.
Modbus TCP/IP server settings ----- Modbus TCP/IP server operation.....enabled Write-access.....disabled Listening port.....502 Max number of sessions.....5 Active sessions.....0	
show security-status monitor	To display the security-status settings.

```
Device Security Settings
Monitor
-----
Password default settings unchanged.....monitored
...
Write access using HiDiscovery is possible....monitored
Loading unencrypted configuration from ENVM...monitored
IEC 61850 MMS is enabled.....monitored
Modbus TCP/IP server active.....monitored
show security-status event          To display occurred security status events.
Time stamp          Event          Info
-----
2014-01-01 01:00:39 password-change(10)          -
.....
2014-01-01 01:00:39 ext-nvm-load-unsecure(21)          -
2014-01-01 23:47:40 modbus-tcp-enabled(23)          -
show network management access rules 1  To display the restricted management access rules
for index 1.

Restricted management access settings
-----
Index.....1
IP Address.....10.17.1.0
Prefix Length.....29
HTTP.....yes
SNMP.....yes
Telnet.....yes
SSH.....yes
HTTPS.....yes
IEC61850-MMS.....yes
Modbus TCP/IP.....yes
Active.....[x]
```

15.2 EtherNet/IP function

EtherNet/IP is an industrial communication protocol that is deployed worldwide and is maintained by the Open DeviceNet Vendor Association (ODVA). It is based on the protocols *TCP/IP* and *UDP/IP* over Ethernet. *EtherNet/IP* is supported by leading manufacturers, thus providing a wide base for effective data communication in the industry sector.

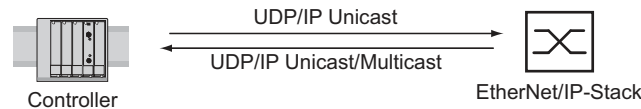

Figure 51: *EtherNet/IP* network

EtherNet/IP adds the industry protocol CIP (Common Industrial Protocol) to the standard Ethernet protocols. *EtherNet/IP* implements CIP at the Session layer and above and adapts CIP to the specific *EtherNet/IP* technology at the Transport layer and below. In the case of automation applications, *EtherNet/IP* implements CIP on the application level. Therefore, *EtherNet/IP* is ideally suited to the industrial control technology sector.

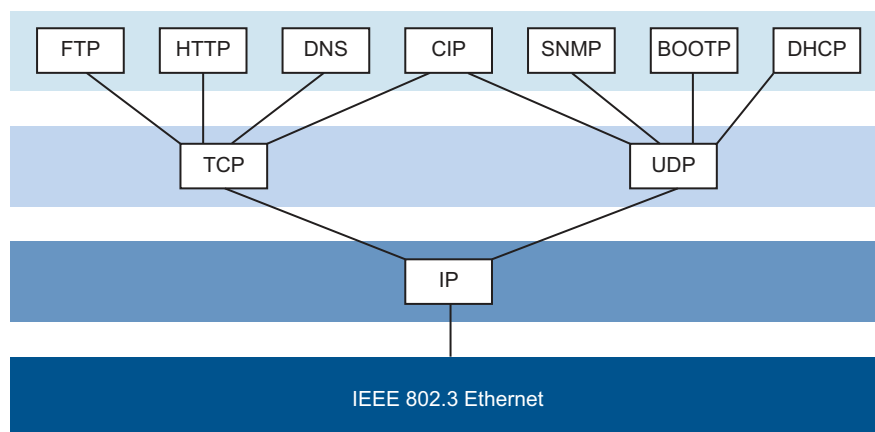

Figure 52: *IEEE 802.3 EtherNet/IP*

In particular, you find *EtherNet/IP* in the USA and in conjunction with Rockwell controllers.

For further information on EtherNet/IP, see the ODVA website at www.odva.org.

15.2.1 Integration into a Control System

Perform the following steps:

- Open the *Switching > IGMP Snooping > Global* dialog. Verify that the *IGMP Snooping* function is enabled.
- Open the *Advanced > Industrial Protocols > EtherNet/IP* dialog. Verify that the *EtherNet/IP* function is enabled.
- Open the *Advanced > Industrial Protocols > EtherNet/IP* dialog.
- To save the EDS as a ZIP archive on your PC, click *Download*. The ZIP archive contains the *EtherNet/IP* configuration file and the icon used to set up the controller to connect to the device.

Configuration of a PLC using the example of Rockwell software

Perform the following steps:

- Open the “EDS Hardware Installation Tool” of RSLinx.
- Use the “EDS Hardware Installation Tool” to add the EDS file.
- Restart the “RSLinx” service so that RSLinx takes over the EDS file of the device.
- Use RSLinx to check if RSLinx has detected the device.
- Open your Logix 5000 project.
- Integrate the device into the Ethernet port of the controller as a new module (Generic Ethernet Module).

Table 42: Settings for integrating a Generic Ethernet Module

Setting	I/O connection	Input only	Listen only
Comm Format	Data - DINT	Data - DINT	Input data - DINT - Run/Program
IP address	IP address of the device	IP address of the device	IP address of the device
Input Assembly Instance	2	2	2
Input Size	7	7	7
Output Assembly Instance	1	254	255
Output Size	1	0	0
Configuration Assembly Instance	3	3	3
Configuration Size	0	0	0

- In the module properties, enter a value of at least 100 ms for the Request Packet Interval (RPI).

Note: Monitoring the I/O connection to the CPU of the device as a detected failure can result in a potential system failure. Therefore, do not consider the I/O connection to the CPU when monitoring.

The I/O connection between the programmable logic controller (PLC) and the device can be interrupted by a management program. For example, a management station can saturate the CPU of the device with higher priority Real Time (RT) data. In this case, the device can still transmit or receive data packets and the system remains operational.

Example of integration from the Sample Code Library

The Sample Code Library is a website from Rockwell. The object of the website is to provide users with a place where they can exchange their best architecture integration applications.

On the website samplecode.rockwellautomation.com, search for catalog number 9701. This is the catalog number of an example for integrating the Hirschmann device into RS Logix 5000 rel. 16, PLC firmware release 16.

15.2.2 EtherNet/IP Entity Parameters

The following paragraphs identify the objects and operations supported by the device.

Supported operations

Table 43: Overview of the supported EtherNet/IP requests for the objects instances

Service Code	Identity Object	TCP/IP Interface Object	Ethernet Link Object	Switch Agent Object	Base Switch Object
0x01 Get Attribute All	All attributes	All attributes	All attributes	All attributes	All attributes
0x02 Set Attribute All	–	Settable attributes (0x3, 0x5, 0x6, 0x8, 0x9, 0xA)	Settable attributes (0x6, 0x9)	–	–
0x0e Get Attribute Single	All attributes	All attributes	All attributes	All attributes	All attributes
0x10 Set Attribute Single	–	Settable attributes (0x3, 0x5, 0x6, 0x8, 0x9, 0xA, 0x64)	Settable attributes (0x6, 0x9, 0x65, 0x67, 0x68, 0x69, 0x6C)	Settable attributes (0x5, 0x7)	–
0x05 Reset	Parameter (0x0, 0x1)	–	–	–	–
0x35 Save Configuration Vendor specific	–	–	–	Save switch configuration	–
0x36 Mac Filter Vendor specific	–	–	–	Add MAC filter STRUCT of: USINT VlanId ARRAY of: 6 USINT Mac DWORD PortMask	–

Identity object

The device supports the identity object (*Class Code 0x01*) of *EtherNet/IP*. The Hirschmann manufacturer ID is 634. Hirschmann uses the ID 44 (0x2C) to indicate the product type "Managed Ethernet Switch".

Table 44: Instance attributes (only instance 1 is available)

Id	Attribute	Access Rule	Data type	Description
0x1	Vendor ID	Get	UINT	Hirschmann634
0x2	Device Type	Get	UINT	Managed Ethernet Switch 44 (0x2C) (0x2C)
0x3	Product Code	Get	UINT	Product Code: mapping is defined for every device type

Table 44: Instance attributes (only instance 1 is available) (cont.)

Id	Attribute	Access Rule	Data type	Description
0x4	Revision	Get	STRUCT of: USINT Major USINT Minor	Revision of the EtherNet/IP implementation, 2.1.
0x5	Status	Get	WORD	Support for the following Bit status only: 0: Owned (constantly 1) 2: Configured (constantly 1) 4: Extend Device Status 5: 0x3: No I/O connection established 6: 0x7: At least one I/O connection established, all in idle mode. 7:
0x6	Serial number	Get	UDINT	Serial number of the device (contains last 3 Bytes of MAC address).
0x7	Product name	Get	SHORT-STRING	Displayed as "Hirschmann" + product family + product ID + software variant.

TCP/IP Interface Object

The device supports only Instance 1 of the TCP/IP Interface Object (Class Code 0xF5) of *EtherNet/IP*.

Depending on the write access status, the device stores the complete settings in its flash memory. Saving the settings can take up to 10 seconds. If the saving process is interrupted for example, due to an inoperable power supply, then the operation of the device might be impossible.

Note: The device replies to the configuration change *Get Request* with a *Response* although the configuration has not yet been saved completely.

Table 45: Class attributes

Id	Attribute	Access Rule	Data type	Description
0x1	Revision	Get	UINT	Revision of this object: 3
0x2	Max Instance	Get	UINT	Maximum instance number: 1
0x3	Number of instance	Get	UINT	Number of object instances currently added: 1

Table 46: Attributes of Instance 1

Id	Attribute	Access Rule	Data type	Description
0x1	Status	Get	DWORD	0: Interface Status (0=Interface not configured, 1=Interface contains valid config) 6: ACD status (default 0) 7: ACD fault (default 0)

Table 46: Attributes of Instance 1 (cont.)

Id	Attribute	Access Rule	Data type	Description
0x2	Interface Capability flags	Get	DWORD	0: BOOTP Client 1: DNS Client 2: DHCP Client 3: DHCP-DNS Update 4: Configuration setable (within CIP) Other bits reserved (0) 7: ACD capable (0=not capable, 1=capable)
0x3	Config Control	Set/Get	DWORD	0: 0x0=using stored config 1: 0x1=using BOOTP 2: 0x2=using DHCP 3: 4: One device uses DNS for name lookup (constantly 0 because it is unsupported) Other bits reserved (0)
0x4	Physical Link Object	Get	STRUCT of: UINT PathSize EPATH Path	Path to the Physical Link Object, constantly {0x20, 0xF6, 0x24, 0x01} describing instance 1 of the Ethernet Link Object.
0x5	Interface Configuration	Set/Get	STRUCT of: UDINT IpAddress UDINT Netmask UDINT GatewayAddress UDINT NameServer1 UDINT NameServer2 STRING DomainName	IP Stack Configuration (IP address, Netmask, Gateway, 2 Name servers (DNS, if supported) and the domain name).
0x6	Hostname	Set/Get	STRING	Hostname (for DHCP DNS Update)
0x7	Safety Network Number			Unsupported
0x8	TTL Value	Get/Set	USINT	Time to live value for IP multicast packets Range 1..255 (default 1)
0x9	Mcast Config	Get/Set	STRUCT of: USINT AllocControl USINT reserved UINT NumMcast UDINT McastStartAddr	Alloc Control = 0 Number of IP multicast addresses = 32 Multicast start address = 239.192.1.0
0xA	Selected Acd	Get/Set	BOOL	0=ACD disable 1=ACD enable (default)

Table 46: Attributes of Instance 1 (cont.)

Id	Attribute	Access Rule	Data type	Description
0xB	Last Conflict Detected	Get	STRUCT of: USINT AcdActivity ARRAY of: 6 USINT RemoteMac ARRAY of: 28 USINT ArpPdu	ACD Diagnostic Parameters

Table 47: Hirschmann extensions to the TCP/IP Interface Object

Id	Attribute	Access Rule	Data type	Description
0x64	Cable Test	Set/Get	STRUCT of: USINT Interface USINT Status	Interface Status (1=Active, 2=Success, 3=Failure, 4=Uninitialized)
0x65	Cable Pair Size	Get	USINT	Size of the Cable Test Result STRUCT of: 2 Pair for 100BASE 4 Pair for 1000BASE
0x66	Cable Test Result	Get	STRUCT of: USINT Interface USINT CablePair USINT CableStatus USINT CableMinLength USINT CableMaxLength USINTCableFailureLocation	100BASE:{ {Interface, CablePair1, CableStatus, CableMinLength, CableMaxLength, CableFailureLocation} {Interface, CablePair2, CableStatus, CableMinLength, CableMaxLength, CableFailureLocation} } 1000BASE:{ {Interface, CablePair1, CableStatus, CableMinLength, CableMaxLength, CableFailureLocation} {Interface, CablePair2, CableStatus, CableMinLength, CableMaxLength, CableFailureLocation} {Interface, CablePair3, CableStatus, CableMinLength, CableMaxLength, CableFailureLocation} {Interface, CablePair4, CableStatus, CableMinLength, CableMaxLength, CableFailureLocation} }

Ethernet Link object

The information in the following tables are part of the Ethernet Link Object. To access the information, use the following values:

- Class(#####)
- Instance(###)
- Attribute(#)

Specify at least one instance in the device, for example, Instance 1 is the CPU Ethernet interface instance (Class Code 0xF6) of *EtherNet/IP*.

Table 48: Instance attributes

Id	Attribute	Access Rule	Data type	Description
0x1	Interface Speed	Get	UDINT	Used interface speed in Mbit/s (10, 100, 1000, ...). 0 is used when the speed has not been determined or is invalid because of detected errors.
0x2	Interface Flags	Get	DWORD	Interface Status Flags: 0: Link State (0=No link, 1=Link) 1: Duplex mode (0=Half, 1=Full) 2: Auto-negotiation Status 3: 0x0=Auto-negotiation in progress 0x1=Auto-negotiation failed 4: 0x2=Failed but speed detected 0x3=Auto-negotiation success 0x4=No Auto-negotiation 5: Manual configuration require reset (constantly 0 because it is not needed) 6: Hardware error
0x3	Physical Address	Get	ARRAY of: 6 USINT	MAC address of physical interface
0x4	Interface Counters	Get	STRUCT of: UDINT MibIICounter1 UDINT MibIICounter2 ...	InOctets, InUcastPackets, InNUcastPackets, InDiscards, InErrors, InUnknownProtos, OutOctets, OutUcastPackets, OutNUcastPackets, OutDiscards, OutErrors
0x5	Media Counters	Get	STRUCT of: UDINT EthernetMib Counter1 UDINT EthernetMib Counter2 ...	Detected errors: Alignment, FCS, single collision, multiple collision, SQE Test, deferred transmissions, late collisions, excessive collisions, MAC TX, carrier sense, frame too long, MAC RX

Table 48: Instance attributes (cont.)

Id	Attribute	Access Rule	Data type	Description
0x6	Interface Control	Get/Set	STRUCT of: WORD ControlBits UINT ForcedInterface Speed	Control Bits: 0: Auto-negotiation enable/disable (0=disable, 1=enable) 1: Duplex mode (0=Half, 1=Full), if Auto-negotiation disabled Interface speed in Mbit/s: 10,100,..., if Auto-negotiation disabled
0x7	Interface type	Get	USINT	Type of interface: 0: Unknown interface type 1: The interface is internal 2: Twisted-pair 3: Optical fiber
0x8	Interface state	Get	USINT	Current state of the interface: 0: Unknown interface state 1: The interface is enabled 2: The interface is disabled 3: The interface is testing
0x9	Admin State	Set/Get	USINT	Administrative state: 1: Enable the interface 2: Disable the interface
0xA	Interface label	Get	SHORT-STRING	Human readable ID

Table 49: Hirschmann extensions to the Ethernet Link Object

Id	Attribute	Access Rule	Data type	Description
0x64	Ethernet Interface Index	Get	USINT	Interface/Port Index (ifIndex out of MIBII)
0x65	Port Control	Get/Set	DWORD	0: Link state (0=link down, 1=link up) 1: Link admin state (0=disabled, 1=enabled) 8: Access violation alarm (read-only) 9: Utilization alarm (read-only)
0x66	Interface Utilization	Get	USINT	The existing Counter out of the private MIB hm2IDiagfaceUtilization is used. Utilization in percentage (Unit 1%=100, %/100). RX Interface Utilization.
0x67	Interface Utilization Alarm Upper Threshold	Get/Set	USINT	Within this parameter the variable hm2DiagIfaceUtilizationAlarmUpperThreshold can be accessed. Utilization in percentage (Unit 1%=100). RX Interface Utilization Upper Limit.
0x68	Interface Utilization Alarm Lower Threshold	Get/Set	USINT	Within this parameter the variable hm2DiagIfaceUtilizationAlarmLowerThreshold can be accessed. Utilization in percentage (Unit 1%=100). RX Interface Utilization Lower Limit.

Table 49: Hirschmann extensions to the Ethernet Link Object (cont.)

Id	Attribute	Access Rule	Data type	Description
0x69	Broadcast limit	Get/Set	USINT	Broadcast limiter Service (Egress BC-Frames limitation, 0=disabled), Frames/second
0x6A	Ethernet Interface Description	Get/Set	STRING	Interface/Port Description (from MIB II ifDescr), for example "Unit: 1 Slot: 2 Port: 1 - 10/100 Mbit TX" or "unavailable", max. 64 Bytes.
0x6B	Port Monitor	Get/Set	DWORD	0: Link Flap (0=Off, 1=On) 1: CRC/Fragment (0=Off, 1=On) 2: Duplex Mismatch (0=Off, 1=On) 3: Overload-Detection (0=Off, 1=On) 4: Link-Speed/ Duplex Mode (0=Off, 1=On) 5: Deactivate port action (0=Off, 1=On) 6: Send trap action (0=Off, 1=On) 7: Active Condition (displays which 8: condition caused an action to 9: occur) 9: 00001 _B : Link Flap 10: 00010 _B : CRC/Fragments 11: 00100 _B : Duplex Mismatch 01000 _B : Overload-Detection 10000 _B : Link-Speed/ Duplex mode 12: Reserved (constantly 0) 13: Reserved (constantly 0) 14: Reserved (constantly 0) 15: Reserved (constantly 0)
0x6C	Quick Connect	Get/Set	USINT	Quick Connect on the interface (0=Off, 1=On) If you enable Quick Connect, then the device sets the port speed to 100FD, disables auto-negotiation, and Spanning Tree on the interface.

Table 49: Hirschmann extensions to the Ethernet Link Object (cont.)

Id	Attribute	Access Rule	Data type	Description
0x6D	SFP Diagnostics	Get	STRUCT of:	
			STRING	ModuleType
			SHORT-STRING	SerialNumber
			USINT	Connector
			USINT	Supported
			DINT	Temperature in °C
			DINT	TxPower in mW
			DINT	RxPower in mW
			DINT	RxPower in dBm
			DINT	TxPower in dBm

Table 50: Assignment of ports to Ethernet Link Object Instances

Ethernet Port	Ethernet Link Object Instance
CPU	1
1	2
2	3
3	4
4	5
...	...

Note: The number of ports depends on the type of hardware used. The Ethernet Link Object only exists, if the port is connected.

Switch Agent object

The device supports the Hirschmann specific Ethernet Switch Agent Object (*Class Code 0x95*) for the device settings and information parameters with Instance 1.

Table 51: Class attributes

Id	Attribute	Access Rule	Data type	Description
0x1	Switch Status	Get	DWORD	0: Like the signal contact, the value indicates the Device Overall state (0=ok, 1=failed)
				1: Device Security Status (0=ok, 1=failed)
				2: Power Supply 1 (0=ok, 1=failed)
				3: Power Supply 2 (0=ok, 1=failed or not existing)
				4-5: Reserved
				6: Signal Contact 1 (0=closed, 1=open)
				7: Signal Contact 2 (0=closed, 1=open or not existing)
				8: Reserved
				9: Temperature (0=ok, 1=failure)
				10: Module removed (1=removed)
				11: ACA21/ACA22 removed (1=removed)
				12: ACA31 removed (1=removed)
				13-22: Reserved
				23: MRP (0=disabled, 1=enabled)
				24: Reserved
				25: Reserved
26: RSTP (0=disabled, 1=enabled)				
27: LAG (0=disabled, 1=enabled)				
28: Reserved				
29-30: Reserved				
31: Connection Error (1=failure)				
0x2	Switch Temperature	Get	STRUCT of:	
			INT TemperatureF	in °F
			INT TemperatureC	in °C
0x3	Reserved	Get	UDINT	Reserved for future use (constantly 0)
0x4	Switch Max Ports	Get	UINT	Maximum number of Ethernet Switch Ports

Table 51: Class attributes (cont.)

Id	Attribute	Access Rule	Data type	Description
0x5	Multicast Settings (IGMP Snooping)	Get/Set	WORD	<p>0: IGMP Snooping (0=disabled, 1=enabled)</p> <hr/> <p>1: IGMP Querier (0=disabled, 1=enabled)</p> <hr/> <p>2: IGMP Querier Mode (read-only) (0=Non-Querier, 1=Querier)</p> <hr/> <p>3:</p> <hr/> <p>4: IGMP Querier Packet Version</p> <hr/> <p>5: Off=0 IGMP Querier disabled V1=1</p> <hr/> <p>6: V2=2</p> <hr/> <p>7: V3=3</p> <hr/> <p>8: Treatment of Unknown</p> <hr/> <p>9: Multicasts:</p> <hr/> <p>10: 0=Send To All Ports 1=Send To Query Ports 2=Discard</p>
0x6	Switch Existing Ports	Get	ARRAY of: DWORD	<p>Bitmask of existing switch ports Per bit starting with Bit 0 (=Port 1) (0=Port not available, 1=Port existing) Array (bit mask) size is adjusted to the size of maximum number of switch ports (for max. 28 Ports 1 DWORD is used)</p>
0x7	Switch Port Control	Get/Set	ARRAY of: DWORD	<p>Bitmask Link Admin Status switch ports Per bit starting with Bit 0 (=Port 1) (0=Port enabled, 1=Port disabled) Array (bit mask) size is adjusted to the size of maximum number of Switch ports (for max. 28 Ports 1 DWORD is used)</p>
0x8	Switch Ports Mapping	Get	ARRAY of: USINT	<p>Instance number of the Ethernet-Link-Object Starting with Index 0 (=Port 1) All Ethernet Link Object Instances for the existing Ethernet Switch Ports (1..N, maximum number of ports). When the entry is 0, the Ethernet Link Object for this port does not exist</p>

Table 51: Class attributes (cont.)

Id	Attribute	Access Rule	Data type	Description
0x9	Switch Action Status	Get	DWORD	Status of the last executed action (for example config save, software update, etc.) <hr/> 0: Flash Save Configuration In Progress/Flash Write In Progress <hr/> 1: Flash Save Configuration Failed/Flash Write Failed <hr/> 4: Configuration changed (configuration not in sync. between running configuration

The Hirschmann specific Ethernet Switch Agent Object provides you with the additional vendor specific service, with the *Service Code 0x35* for saving the device settings. When you send a request from your PC to save the device settings, the device sends a reply after saving the settings in the flash memory.

Base Switch object

The Base Switch object provides the CIP application-level interface to basic status information for a managed Ethernet switch (revision 1).

Only Instance 1 of the Base Switch (*Class Code 0x51*) is available.

Table 52: Instance attributes

Id	Attribute	Access Rule	Data type	Description
0x1	Device Up Time	Get	UDINT	Time since the device powered up
0x2	Total port count	Get	UDINT	Number of physical ports
0x3	System Firmware Version	Get	SHORT-STRING	Human readable representation of System Firmware Version
0x4	Power source	Get	WORD	Status of switch power source
0x5	Port Mask Size	Get	UINT	Number of DWORD in port array attributes
0x6	Existing ports	Get	ARRAY of: _____ DWORD	Port Mask
0x7	Global Port Admin State	Get	ARRAY of: _____ DWORD	Port Admin Status
0x8	Global Port link Status	Get	ARRAY of: _____ DWORD	Port Link Status
0x9	System Boot Loader Version	Get	SHORT-STRING	Readable System Firmware Version
0xA	Contact Status	Get	UDINT	Switch Contact Closure

Table 52: Instance attributes (cont.)

Id	Attribute	Access Rule	Data type	Description
0xB	Aging Time	Get	UDINT	Range 10..1000000 · 1/10 seconds (default 300) 0=Learning off
0xC	Temperature C	Get	DINT	Switch temperature in degrees Celsius
0xD	Temperature F	Get	DINT	Switch temperature in degrees Fahrenheit

Message Router

The Message Router object (*Class Code 0x20*) distributes *Explicit Request* messages to the appropriate handler object.

Table 53: Class attributes

Id	Attribute	Access Rule	Data type	Description
1	Revision	Get	UINT	Revision: 1
2	Largest Instance Number	Get	UINT	Largest instance number: 1
3	Number of Instances Currently Existing	Get	UINT	Number of instances currently existing: 1
4	Optional Attribute List	Get	ARRAY of: BYTES	Optional attribute list: 0 Unsupported for Get_single service
5	Optional Service List	Get	ARRAY of: BYTES	Optional Service List: 0 Unsupported for Get_single service
6	Maximum ID Number Class Attributes	Get	UINT	Maximum ID Number Class Attributes: 7
7	Maximum ID Number Instance Attributes	Get	UINT	Maximum ID Number Instance Attributes: 0

Assembly

The Assembly object (*Class Code 0x04*) binds attributes of multiple objects. This property lets the device send or receive data to or from any object over a single connection. You can use Assembly objects to bind *Input* or *Output* data. The terms *Input* and *Output* are specified from the viewpoint of the network. *Input* produces data on the network and *Output* consumes data from the network.

Table 54: Supported instances

Instance	Description	Service
1	POWER_LINK_ASSEMBLY	Get_single
100	INPUT_ASSEMBLY_NUM	Get_single
150	OUTPUT_ASSEMBLY	Get_single/Set_single
151	CONFIG_ASSEMBLY_NUM	Get_single/Set_single

Table 54: Supported instances (cont.)

Instance	Description	Service
152	HEARBEAT_INPUT_ONLY_ASSEMBLY	Get_single/Set_single
153	HEARBEAT_LISTEN_ONLY_ASSEMBLY	Get_single/Set_single
154	EXPLICIT_ASSEMBLY	Get_single/Set_single

Table 55: Class attributes

Id	Attribute	Access rule	Data type	Description
1	Revision	Get	UINT	Revision: 2
2	Largest Instance Number	Get	UINT	Largest instance number: 154
3	Number of Instances Currently Existing	Get	UINT	Number of instances currently existing: 7
4	Optional Attribute List			Unsupported
5	Optional Service List			Unsupported
6	Maximum ID Number Class Attributes	Get	UINT	Maximum ID Number Class Attributes: 7
7	Maximum ID Number Instance Attributes	Get	UINT	Maximum ID Number Instance Attributes: 4

Table 56: Instance attributes

Id	Attribute	Access Rule	Data type	Description
3	Data	Get	ARRAY of: BYTES	
4	Size	Get	UINT	Number of bytes in Attribute 3

Connection Manager

The Connection Manager Class (*Class Code 0x06*) allocates and manages the internal resources associated with both *I/O* and *Explicit Messaging* connections.

Table 57: Class attributes

Id	Attribute	Access rule	Data type	Description
1	Revision	Get	UINT	Revision: 1
2	Largest Instance Number	Get	UINT	largest instance number: 1
3	Number of Instances Currently Existing	Get	UINT	Number of instances currently existing: 1
4	Optional Attribute List			Unsupported

Table 57: Class attributes (cont.)

Id	Attribute	Access rule	Data type	Description
5	Optional Service List			Unsupported
6	Maximum ID Number Class Attributes	Get	UINT	Maximum ID Number Class Attributes: 7
7	Maximum ID Number Instance Attributes	Get	UINT	Maximum ID Number Instance Attributes: 14

QoS object

The QoS object (0x48) provides sending EtherNet/IP messages with non-zero DiffServ code points (DSCP). The QoS object supports one instance.

Table 58: Class attributes

Id	Attribute	Access Rule	Data type	Description
0x1	Revision	Get	UINT	Revision of this object: 1
0x2	Max Instance	Get	UINT	Maximum instance number: 1
0x3	Number of instance	Get	UINT	Number of object instances currently added: 1
0x4	Optional Attribute List			Unsupported
0x5	Optional Service List			Unsupported
0x6	Maximum ID Number Class Attributes	Get	UINT	Maximum ID Number Class Attributes: 7
0x7	Maximum ID Number Instance Attributes	Get	UINT	Maximum ID Number Instance Attributes: 8

Table 59: Instance attributes

Id	Attribute	Access Rule	Data type	Description
0x1	802.1Q TagEnable			Unsupported
0x2	DSCP PTP Event			Unsupported
0x3	DSCP PTPGeneral			Unsupported
0x4	DSCP Urgent	Get/Set	USINT	DSCP value for CIP transport class 0/1 Urgent priority messages. (default 55)
0x5	DSCP Scheduled	Get/Set	USINT	DSCP value for CIP transport class 0/1 Scheduled priority messages. (default 47)

Table 59: Instance attributes (cont.)

Id	Attribute	Access Rule	Data type	Description
0x6	DSCP High	Get/Set	USINT	DSCP value for CIP transport class 0/1 High priority messages. (default 43)
0x7	DSCP Low	Get/Set	USINT	DSCP value for CIP transport class 0/1 Low priority messages. (default 31)
0x8	DSCP Explicit	Get/Set	USINT	DSCP value for CIP explicit messages (transport class 2/3 and UCMM) and all other EtherNet/IP encapsulation messages. (default 27)

Services, Connections and I/O Data

The device supports the following connection types and parameters.

Table 60: Settings for integrating a new module

Setting	I/O connection	Input only	Listen only
Comm Format:	Data - DINT	Data - DINT	Input Data - DINT - Run/Program
IP address	IP address of the device	IP address of the device	IP address of the device
Input Assembly Instance	100	100	100
Input Size	32	32	32
Output Assembly Instance	150	152	153
Output Size	32	0	0
Configuration Assembly Instance	151	151	151
Data Size	10	10	10

Table 61: Device I/O data structure

I/O Data	Value (data types and sizes to be defined)	Direction	Size ¹
Device Status	Bitmask (see Switch Agent Attribute 0x1)	Input	DWORD
Link Status	Bitmask, 1 Bit per port (0=No link, 1=Link up)	Input	DWORD
Output Links Admin State applied	Bitmask (1 Bit per port) to acknowledge output. Link state change can be denied, for example for controller access port. (0=Port enabled, 1=Port disabled)	Input	DWORD
Utilization Alarm ²	Bitmask, 1 Bit per port (0=No alarm, 1=Alarm on port)	Input	DWORD
Access Violation Alarm ³	Bitmask, 1 Bit per port (0=No alarm, 1=Alarm on port)	Input	DWORD
Multicast Connections	Integer, number of connections	Input	DINT

Table 61: Device I/O data structure (cont.)

I/O Data	Value (data types and sizes to be defined)	Direction	Size ¹
TCP/IP Connections	Integer, number of connections	Input	DINT
Quick Connect Mask	Bitmask (1 Bit per port) (0=Quick Connect disabled, 1=Quick Connect enabled)	Input	DINT
Link Admin State	Bitmask, 1 Bit per port (0=Port enabled, 1=Port disabled)	Output	DWORD

1. The default size of the port bit masks is 32 bits (DWORD). For devices with more than 28 ports the port bit masks have been extended to n * DWORD.
2. You specify the utilization alarm settings in the *Basic Settings > Port* dialog, *Ingress Utilization* tab. The upper threshold value is the limit, where the alarm condition becomes active. The lower threshold value is the limit, where an active alarm condition becomes inactive.
3. You specify the Access Violation alarm settings in the *Network Security > Port Security* dialog. The upper threshold value is the limit, where the alarm condition becomes active. The lower threshold value is the limit, where an active alarm condition becomes inactive.

Table 62: Mapping of the data types to bit sizes

Object type	Bit size
BOOL	1 bit
DINT	32 bit
DWORD	32 bit
SHORT-STRING	max. 32 bytes
STRING	max. 64 bytes
UDINT	32 bit
UINT	16 bit
USINT	8 bit
WORD	16 bit

15.3 PROFINET function

PROFINET is an industrial communication protocol that is deployed worldwide. It is based on the protocols *TCP/IP* and *UDP/IP* over Ethernet. This is a crucial aspect in fulfilling the requirements for consistency from the management level right down to the field level.

PROFINET enhances the existing Profibus technology for applications that require fast data communication and the use of industrial IT functions.

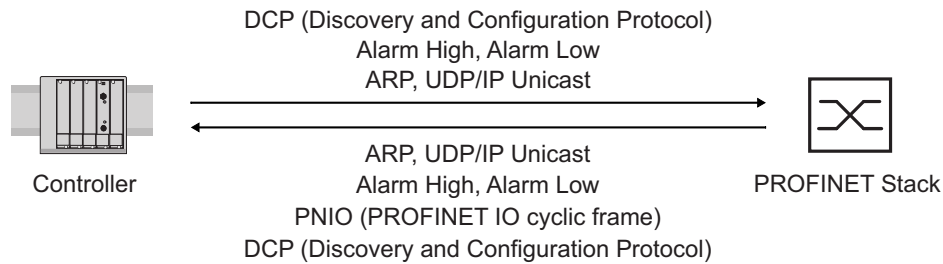

Figure 53: Communication between the Controller and the device

In particular, you find **PROFINET** in Europe and with Siemens controllers.

PROFINET uses the device description language GSDML (Generic Station Description Markup Language, based on XML) to describe devices and their properties so that they can be processed automatically. You find the device description in the GSD (Generic Station Description) file of the device.

For further information on PROFINET, see the PROFIBUS Organization website at www.profibus.com.

The devices conform to class B for **PROFINET**.

15.3.1 Device Models for PROFINET GSDML Version 2.41

The device generates GSDML files in the GSDML V.2.41 format. Within the GSDML file, the device is modeled according to GSDML standard V.2.4.

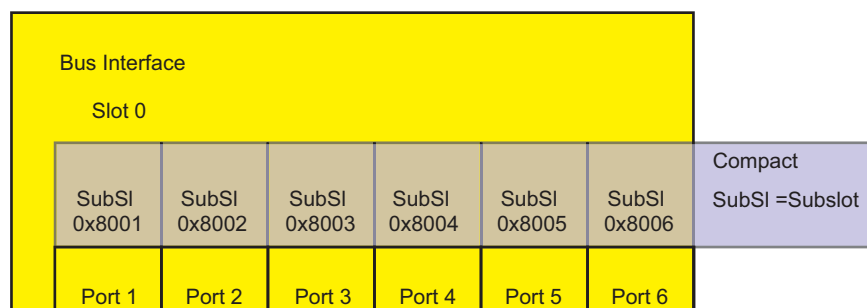

Figure 54: Compact device

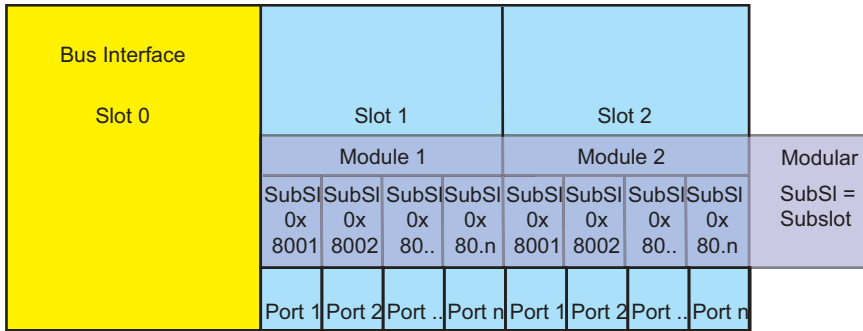

Figure 55: Modular device

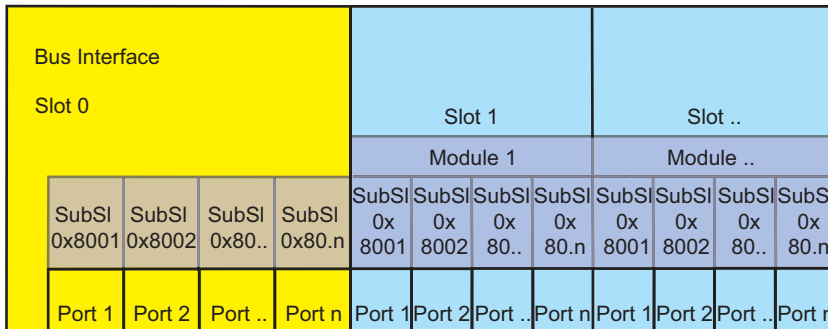

Figure 56: Mixed device

15.3.2 Graphical User Interface and Command Line Interface

When you set up the device successfully in a *PROFINET* environment, the PROFINET IO controller establishes an Application Relation (AR) with the device.

After the user logs into the device management through the Command Line Interface, the device displays a message that an Application Relation is active. In the *Advanced > Industrial Protocols > PROFINET* dialog, the Graphical User Interface displays equivalent information, for example, the number of running Application Relations.

15.3.3 Integrating the device into a Control System

Preparing the device

First you install, connect and set up the device. Then you integrate the device into a Control System. To do this, perform the following steps:

- Open the *Basic Settings > System* dialog.
- Verify that a valid system name for the device is specified in the *System name* field.
- Apply the settings temporarily. To do this, click the ✓ button.
- Open the *Basic Settings > Network > IPv4* dialog.
- In the *Management interface* frame, select the *Local* radio button.

- Apply the settings temporarily. To do this, click the ✓ button.
- Open the *Diagnostics > Status Configuration > Device Status* dialog, *Global* and *Port* tabs.
- Set up the alarms you want to monitor.
- Apply the settings temporarily. To do this, click the ✓ button.
- Open the *Advanced > Industrial Protocols > PROFINET* dialog.
- Download the GSD(ML) file and the icon onto your local computer.
- To enable the *PROFINET* function, select the *On* radio button in the *Operation* frame.
- Apply the settings temporarily. To do this, click the ✓ button.

Changing the default values

Functions that directly affect the *PROFINET* function require the following default values to be changed. When you obtain the device as a specially available *PROFINET* variant, the following values are already predefined:

<i>PROFINET</i>	<i>Advanced > Industrial Protocols > PROFINET</i> dialog <ul style="list-style-type: none"> • <i>Operation</i> = <i>On</i> • <i>Name of station</i> = "" (empty string)
<i>Network</i>	<i>Basic Settings > Network > Global</i> dialog <ul style="list-style-type: none"> • <i>HiDiscovery protocol v1/v2 Access</i> = <i>readOnly</i> <i>Basic Settings > Network > IPv4</i> dialog <ul style="list-style-type: none"> • <i>IP address assignment</i> = <i>Local</i> • <i>IP address</i> = 0.0.0.0 • <i>Netmask</i> = 0.0.0.0 • <i>Gateway address</i> = 0.0.0.0
<i>VLAN</i>	<i>Switching > Global</i> dialog <ul style="list-style-type: none"> • <i>VLAN-unaware mode</i> = marked
<i>LLDP</i>	<i>Diagnostics > LLDP > Configuration</i> dialog <ul style="list-style-type: none"> • <i>Transmit interval [s]</i> = 5 • <i>Transmit delay [s]</i> = 1

Configuring the PLC

The following illustrates the configuration of the PLC using the example of the TIA Portal software from Siemens, and assumes that you are familiar with operating the software.

The device also supports engineering stations from other manufacturers, such as PC Worx from Phoenix Contact.

In the PLC default setting, the PLC detects the interruption of the I/O connection to the device and treats the interruption as a failure. The PLC considers 3 consecutive real time packets missing from a partner PLC or from the device as an interruption. According to the default setting, the PLC treats this as a system failure. To change this default setting, you employ TIA Portal programming measures.

Note: Monitoring the I/O connection to the CPU of the device as a detected failure can result in a potential system failure. Therefore, do not consider the I/O connection to the CPU when monitoring.

The device management data packets can interrupt the I/O connection between the PLC and the device. For example, a management station can saturate the CPU of the device with higher priority real time data. In this case, because the device can still transmit or receive data packets, the system remains operational.

Providing the GSDML file

The Hirschmann device provides you with the following option for generating GDSML files and icons:

- ▶ You can use the *Advanced > Industrial Protocols > PROFINET* dialog in the GUI to download the GSDML file and the icon of the device.

15.3.4 Incorporating the device in the configuration

Incorporating the GSDML-based device in the network device settings includes the following actions:

- [“Incorporating the device” on page 297](#)
- [“Renaming the device” on page 302](#)
- [“Setting up the IO Cycle” on page 307](#)
- [“Setting up Media Redundancy” on page 313](#)
- [“Adding modules for modular devices” on page 318](#)
- [“Adding digital I/O modules in non-modular devices” on page 322](#)
- [“Adding digital I/O modules in modular devices” on page 326](#)
- [“Adding an SFP transceiver as a submodule in non-modular devices” on page 330](#)
- [“Configuring the port properties” on page 333](#)
- [“Configuring the connection options” on page 338](#)
- [“Swapping devices” on page 347](#)
- [“Topology discovery” on page 347](#)
- [“Configuring the topology” on page 348](#)
- [“Communication diagnosis” on page 348](#)

Incorporating the device

Perform the following steps:

- Open the *TIA Portal* application.
- Open your project. To do this, select your project and click the *Open* button.

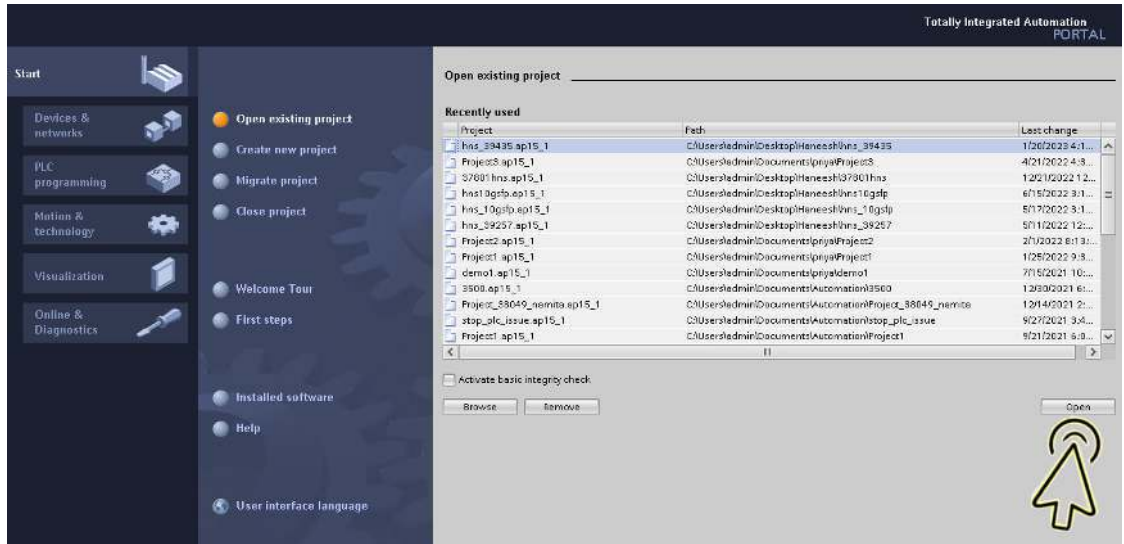

- In the *Project view* frame, select the *Open the project view* object.

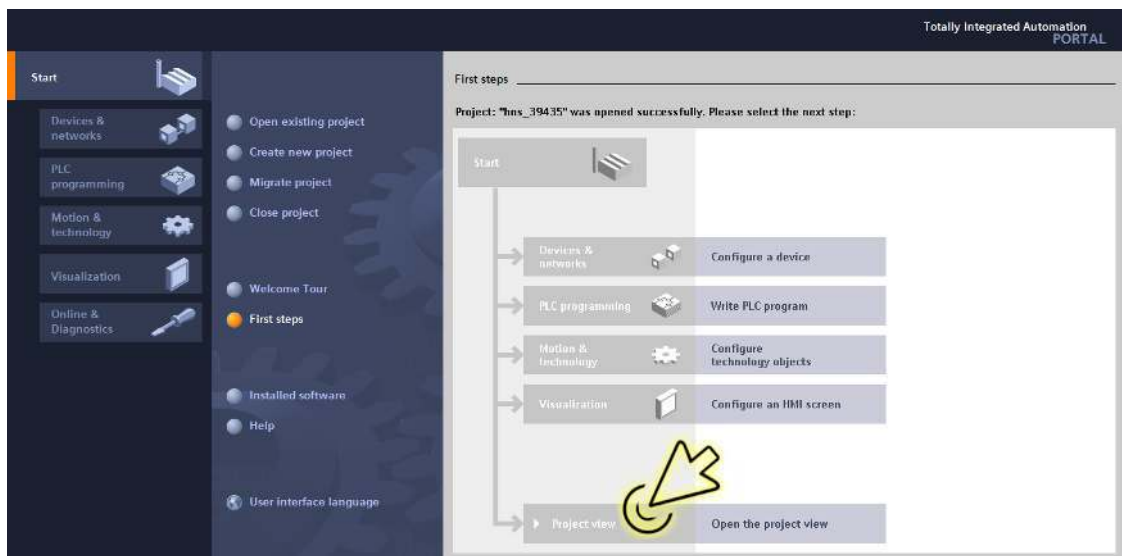

- Install the GSDML file.

- In the menu bar, click the items *Options > Manage general station description files (GSD)*.

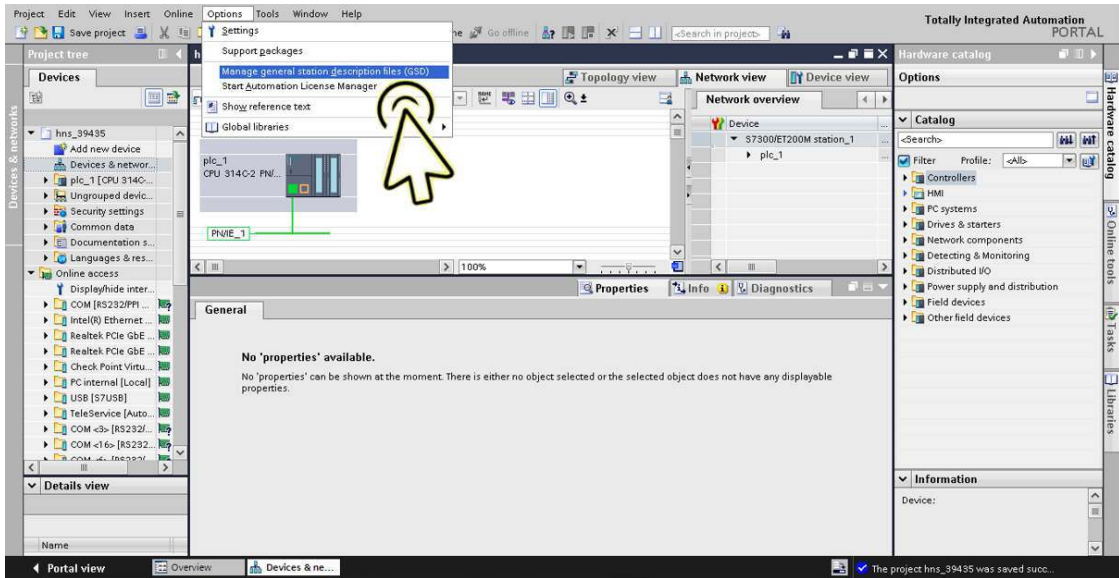

- In the *Manage general station description files* dialog, *Installed GSDs* tab, *Source path* field, browse and select the GSD folder for the GSDML file previously saved on your computer. Click the *OK* button.

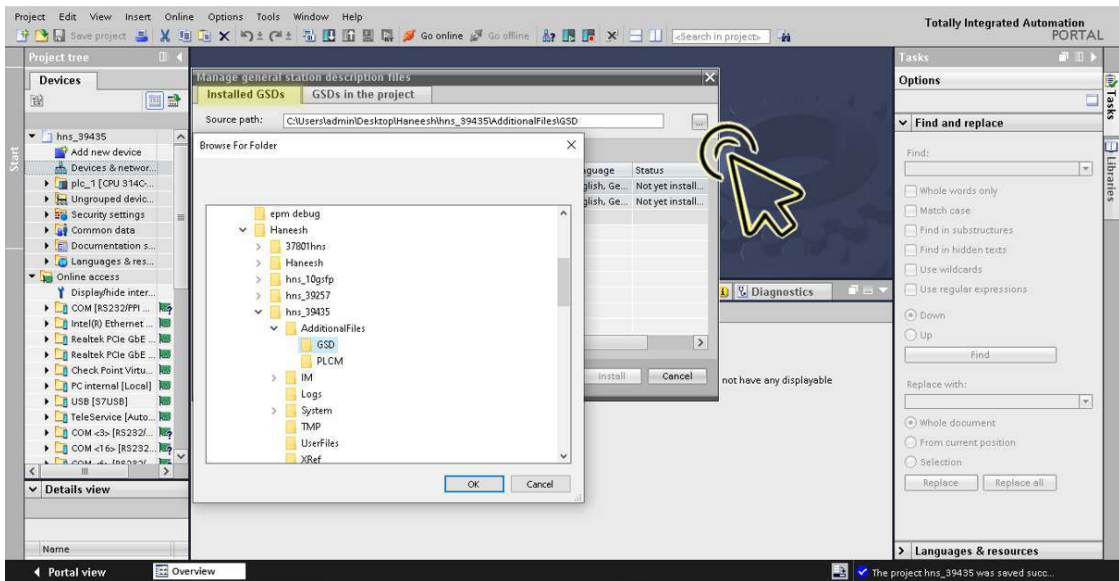

- Mark the GSDML file and click the *Install* button.

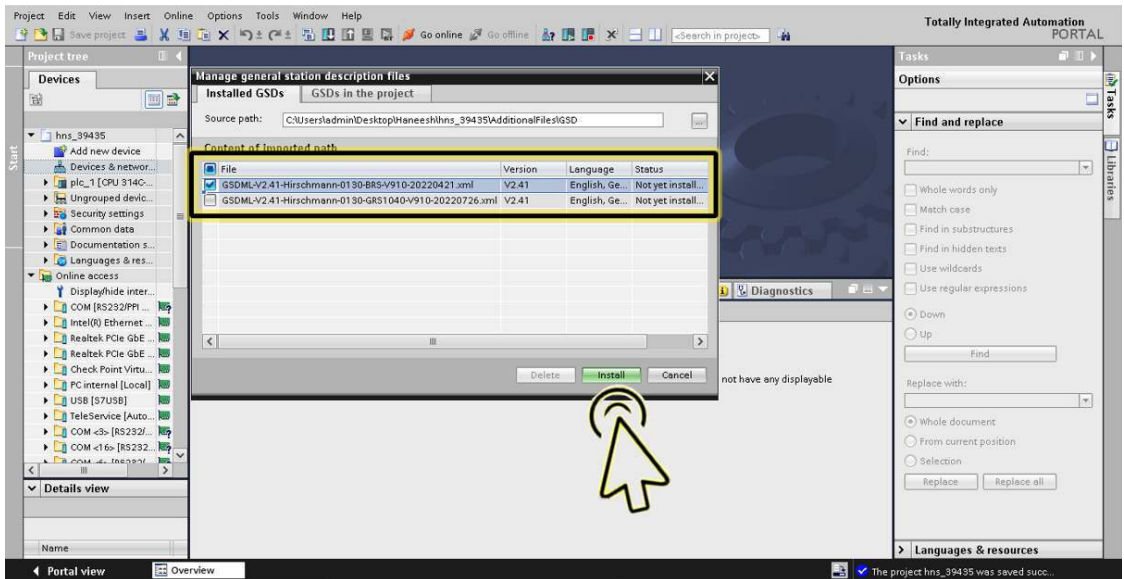

- After the GSDML file installation is completed, click the *Close* button.

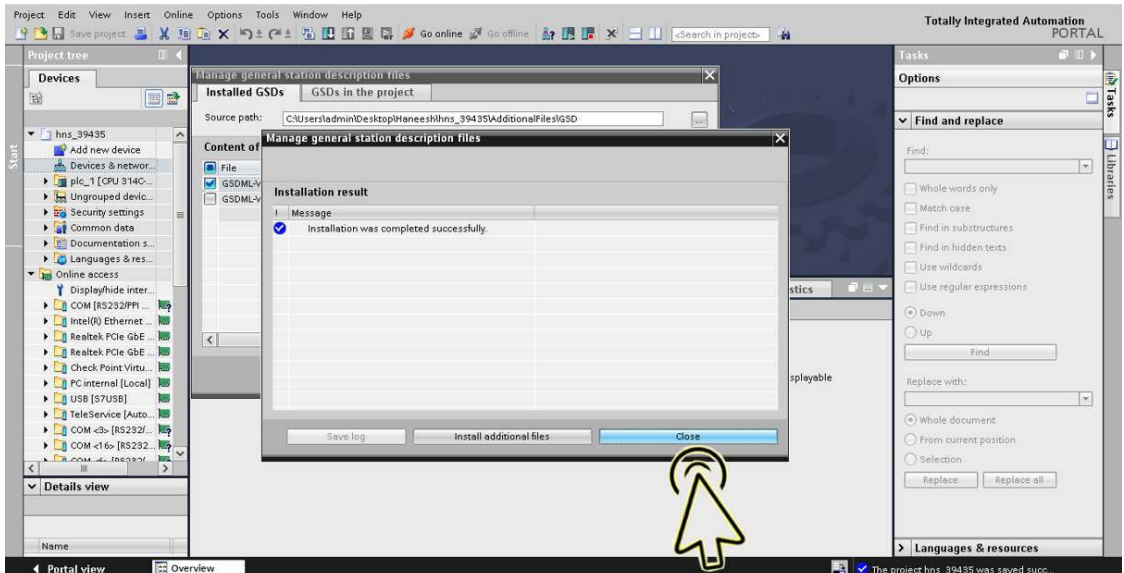

You find the new device under the items *Other field devices > PROFINET IO > Network Components > Hirschmann Automation and Control GmbH*.

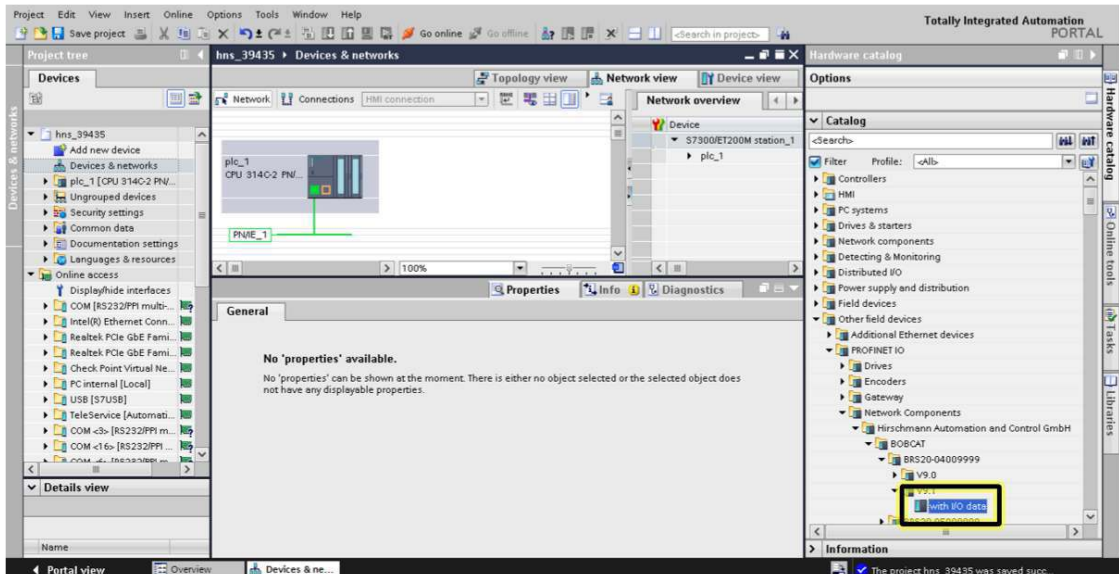

□ Drag the selected device and drop it onto the *Network view* worksheet.

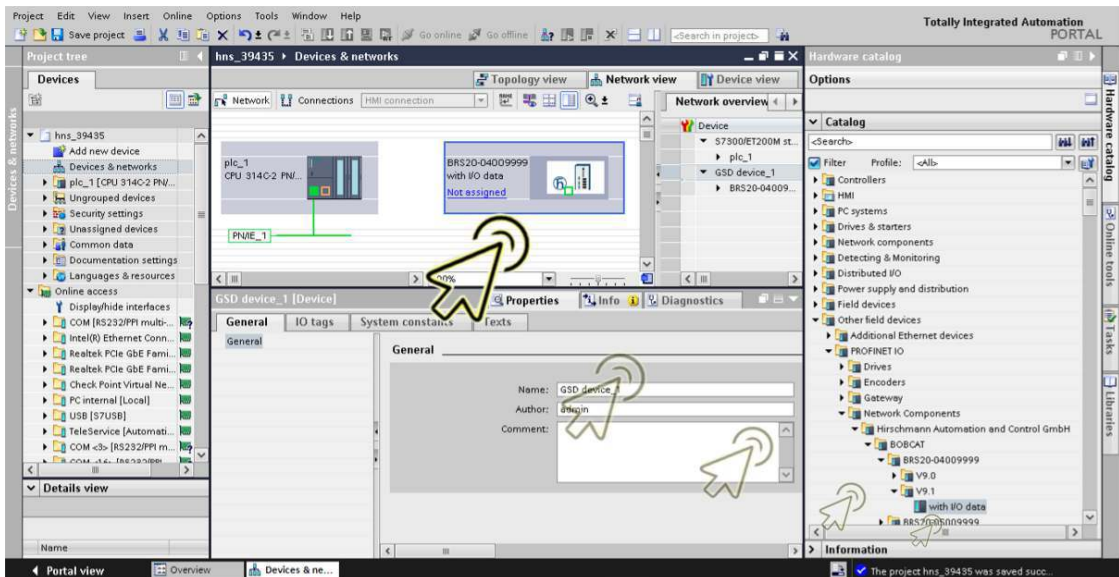

- Assign the device to the PLC. To do this, click the *Not assigned* link in the device tile, then select the required item.

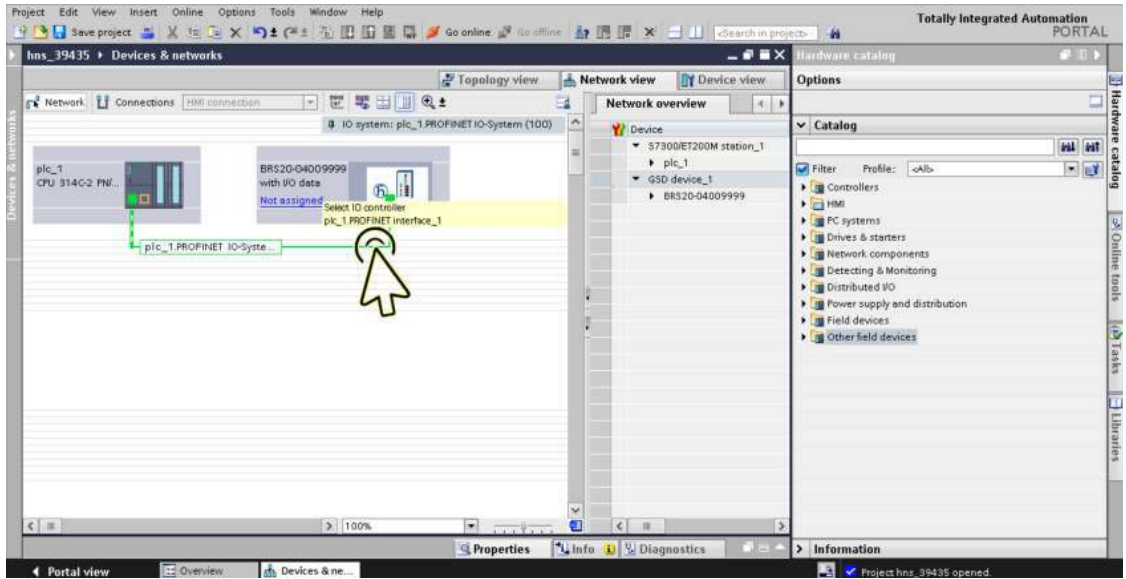

- Click the *Save project* icon.

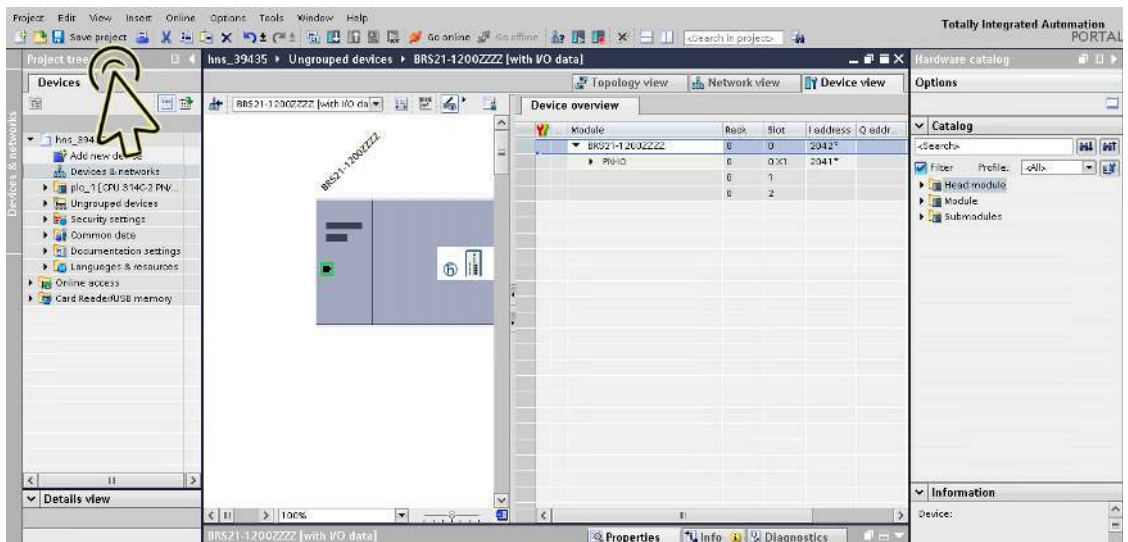

Renaming the device

Perform the following steps:

- Click the *Project view* icon.

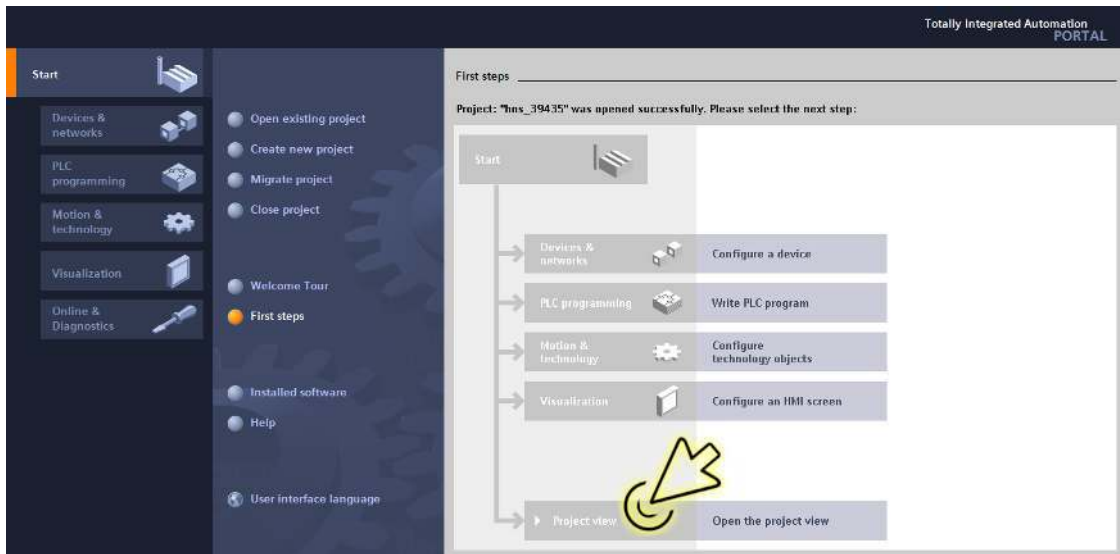

The dialog displays the *Project view* window.

- Click the *Overview* tab in the footer.

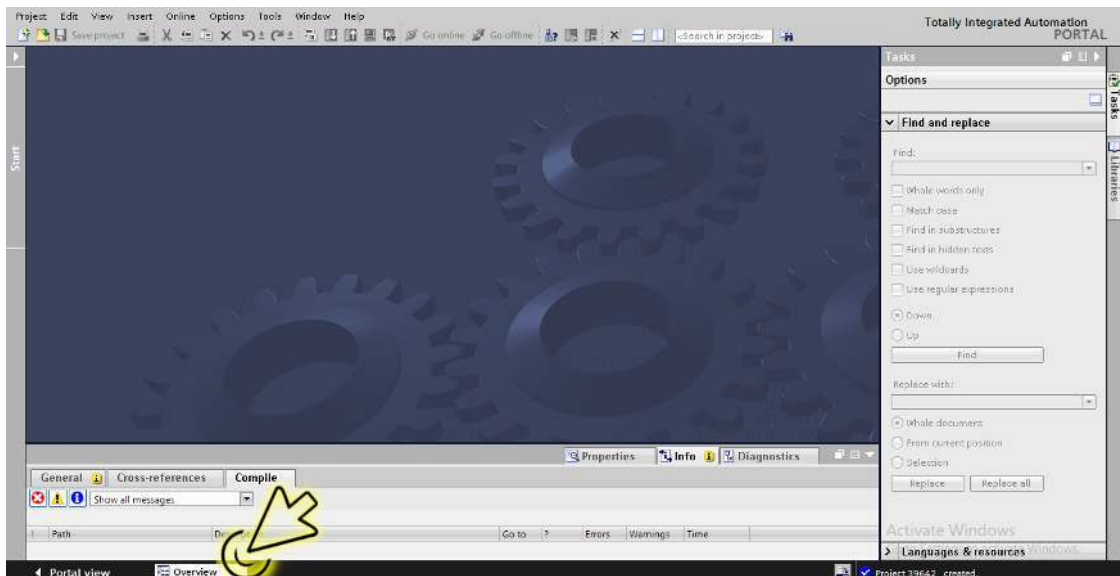

The dialog displays the *Overview* window.

- Double-click the *Devices & networks* icon.

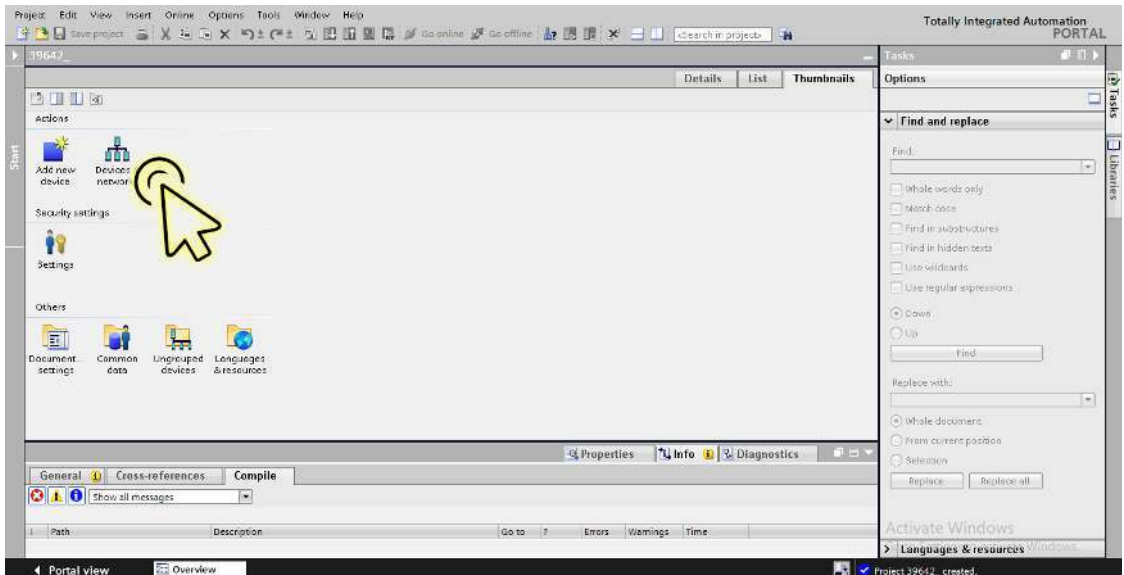

The dialog displays the *Devices & networks* window.

- In the *Network view* tab, click the icon of the device.

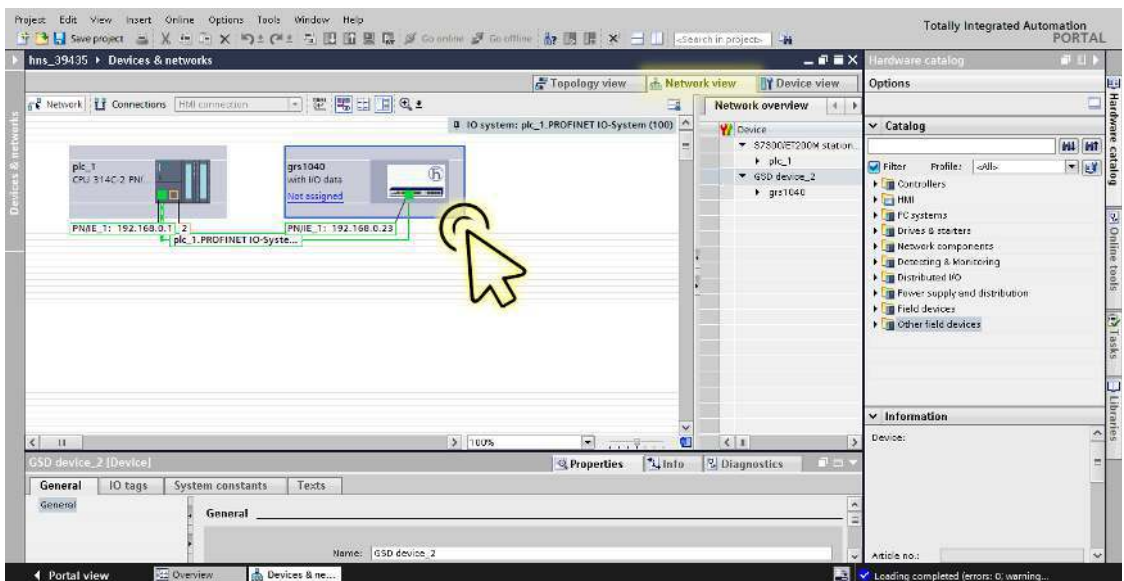

- Select the *Device view* tab to display the device details.

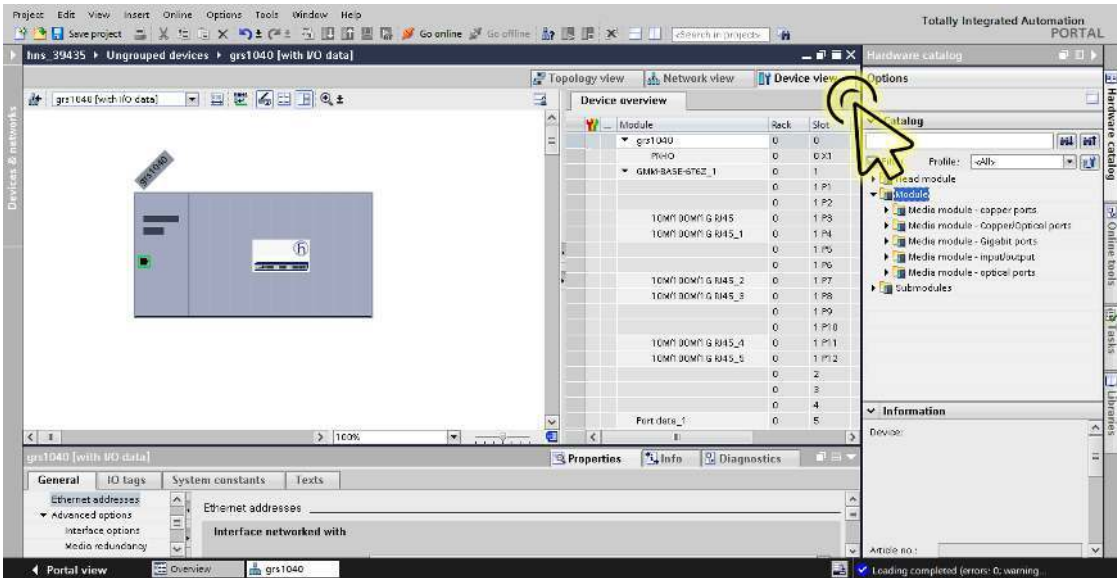

- Select the *Properties* tab. The *Properties* tab contains additional tabs.

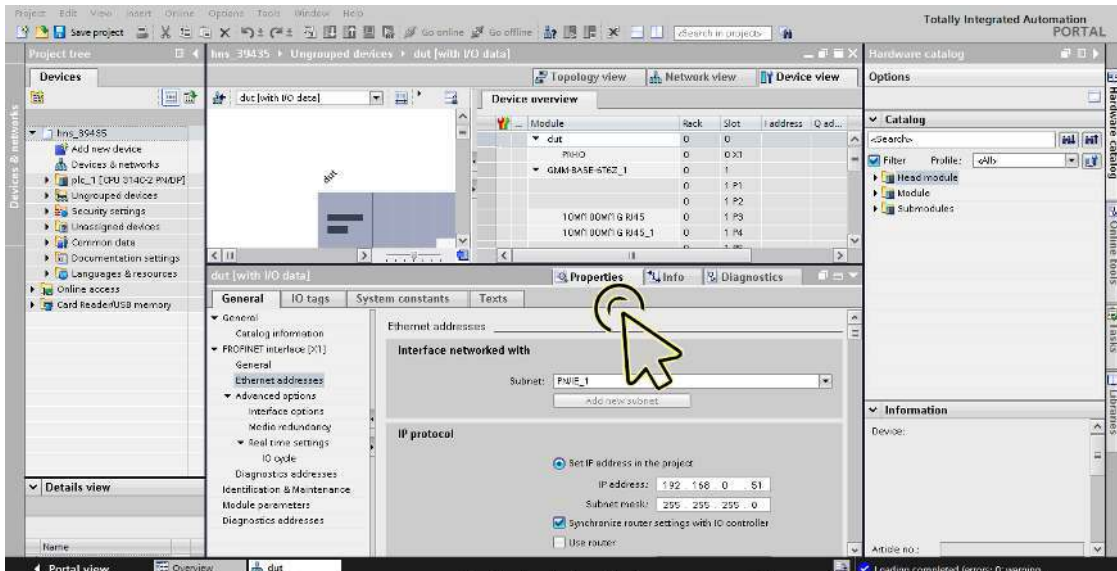

- In the tree view, *PROFINET interface [X1]* branch, select the *Ethernet addresses* item.

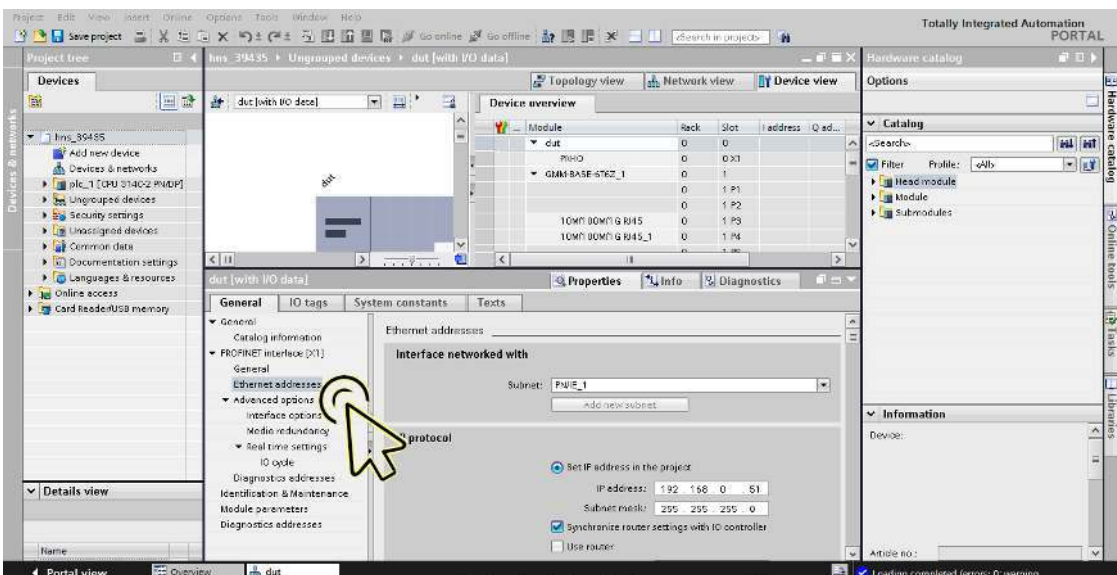

- In the *IP protocol* frame, select the *Set IP address in the project* radio button.

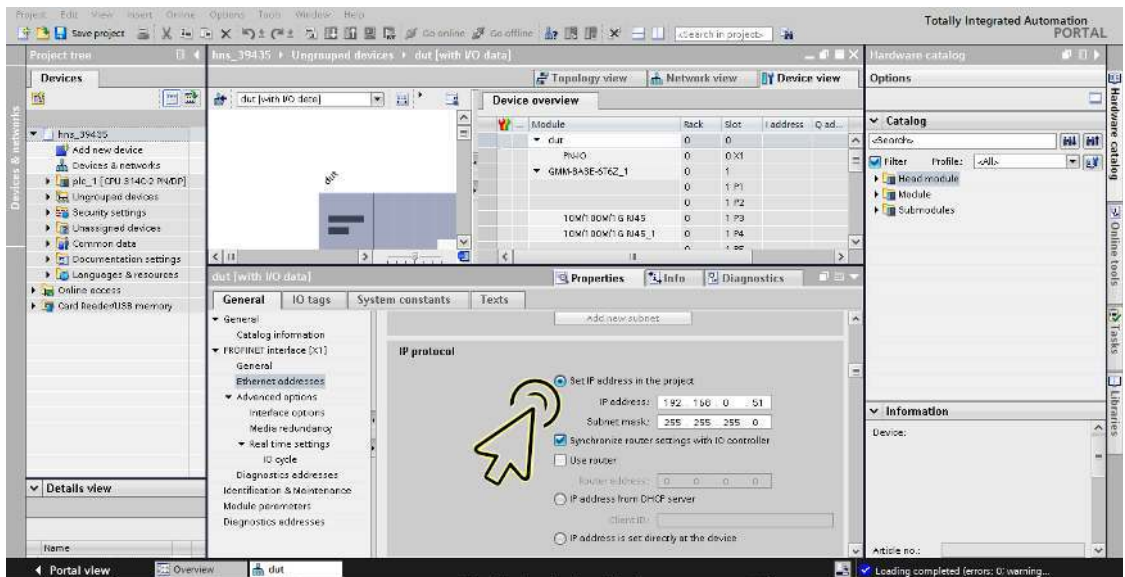

- In the *IP address* field, enter the required IP address.

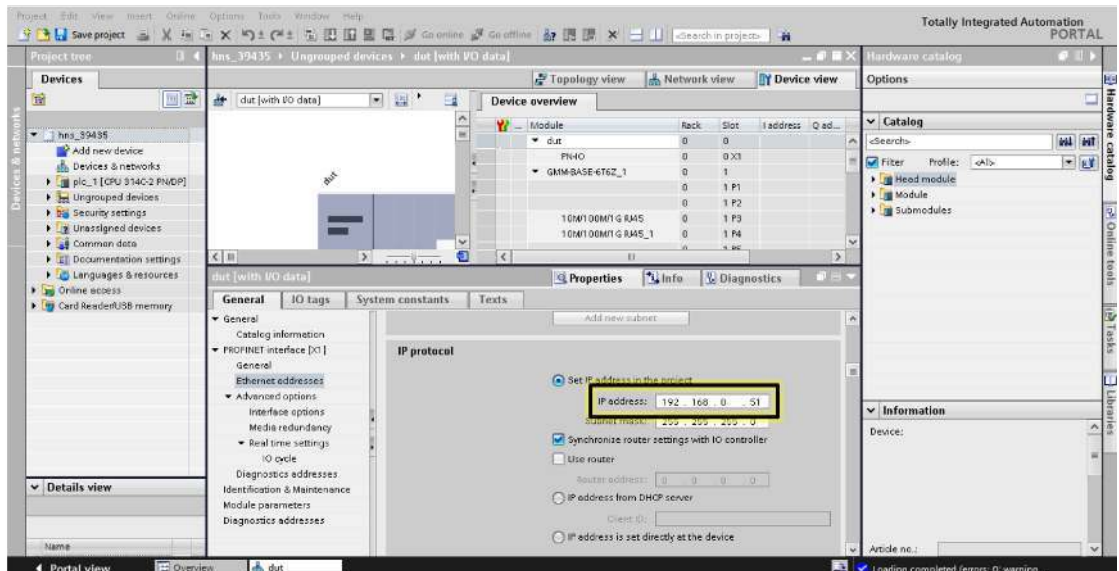

- In the *PROFINET* frame, unmark the *Generate PROFINET device name automatically* checkbox.

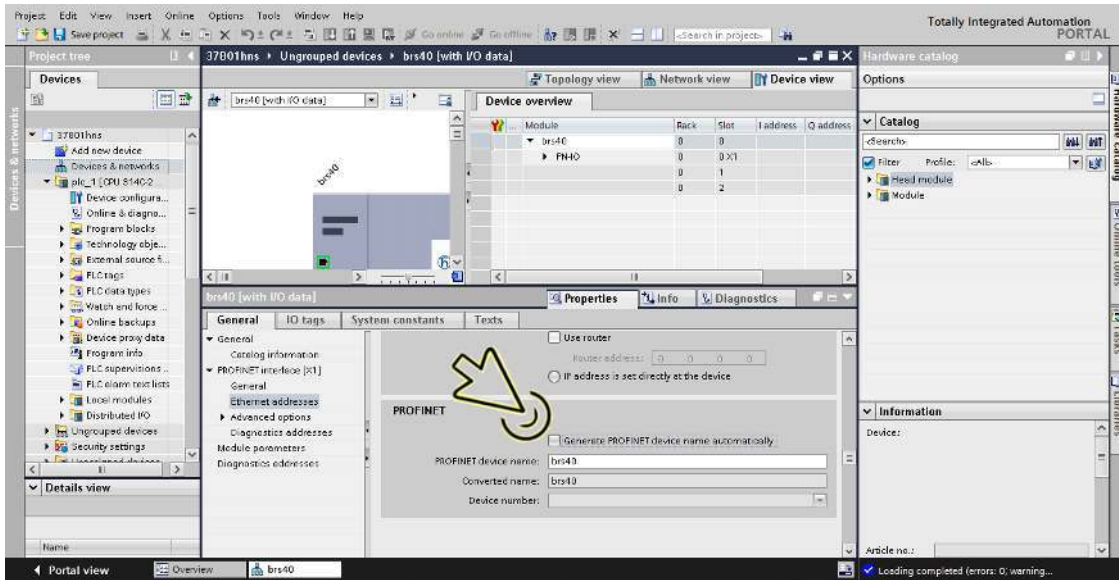

- Enter the same name as specified in the Hirschmann device in the *PROFINET device name* item.

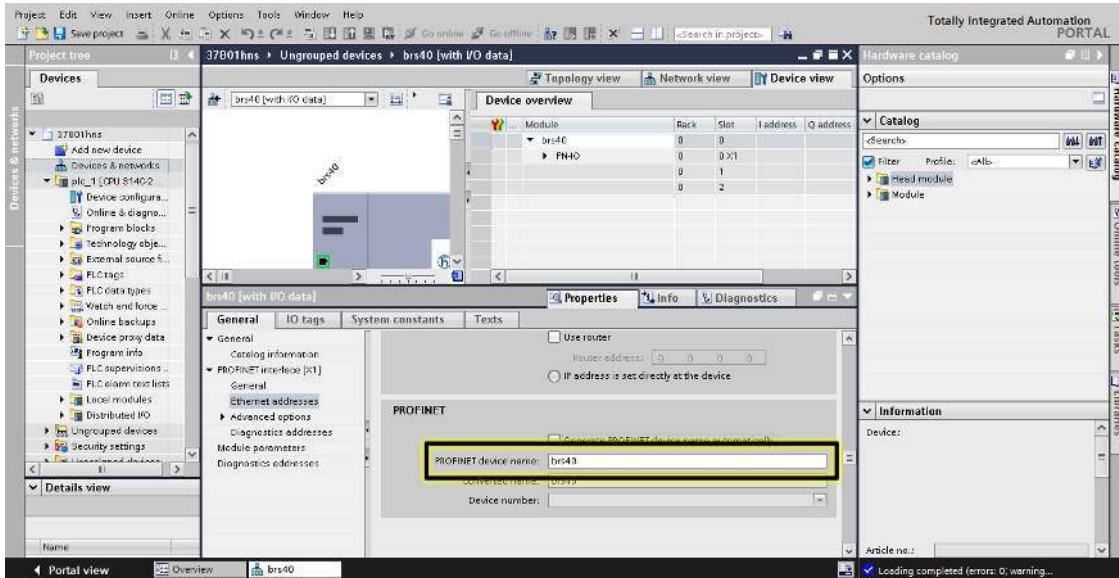

The device is now included in the configuration.

Setting up the IO Cycle

Perform the following steps:

- Click the *Project view* icon.

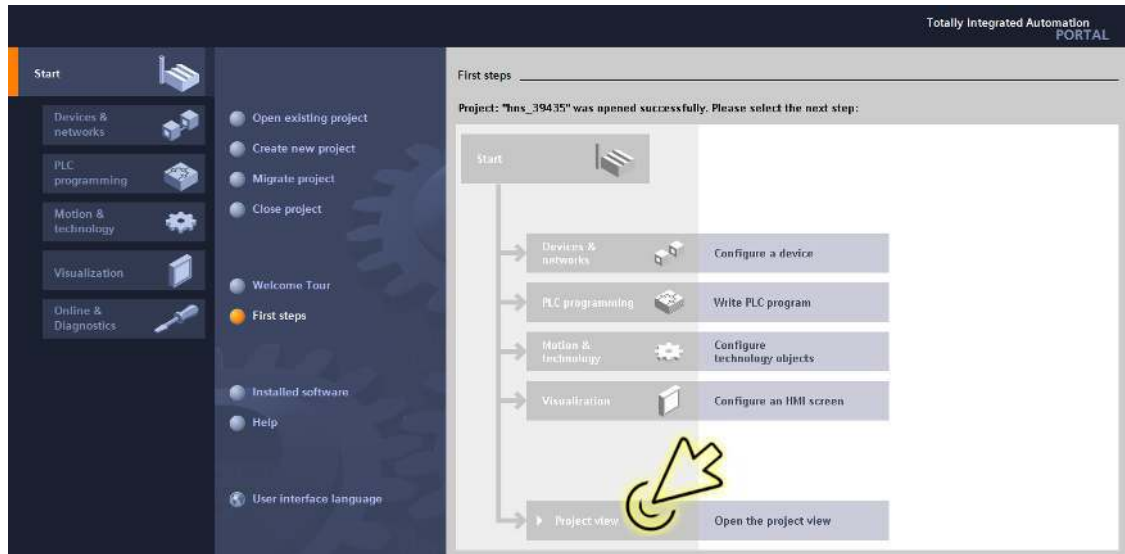

The dialog displays the *Project view* window.

- Click the *Overview* tab in the footer.

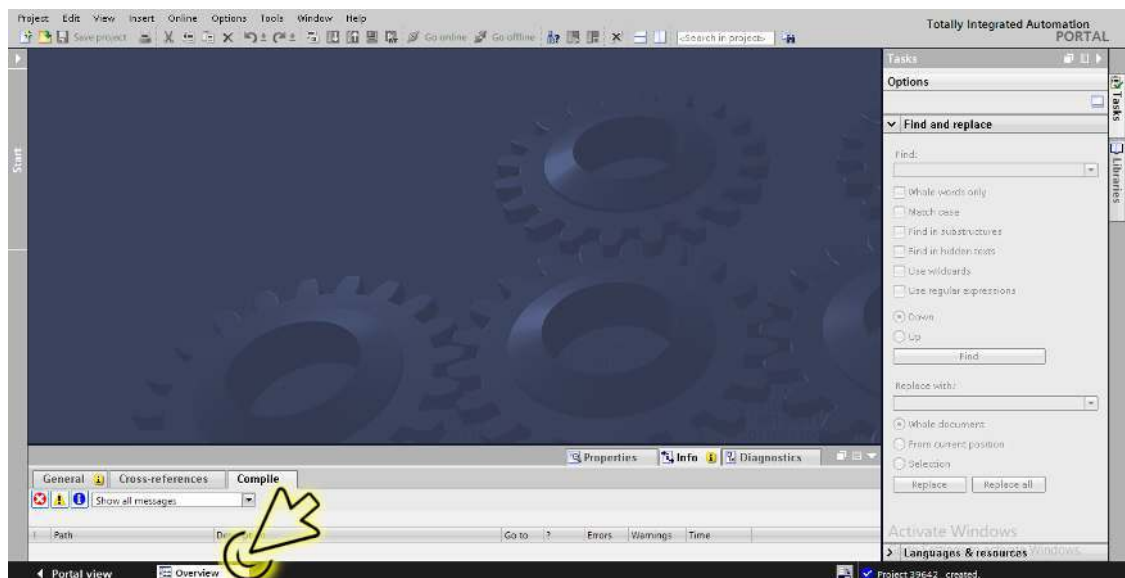

The dialog displays the *Overview* window.

- Double-click the *Devices & networks* icon.

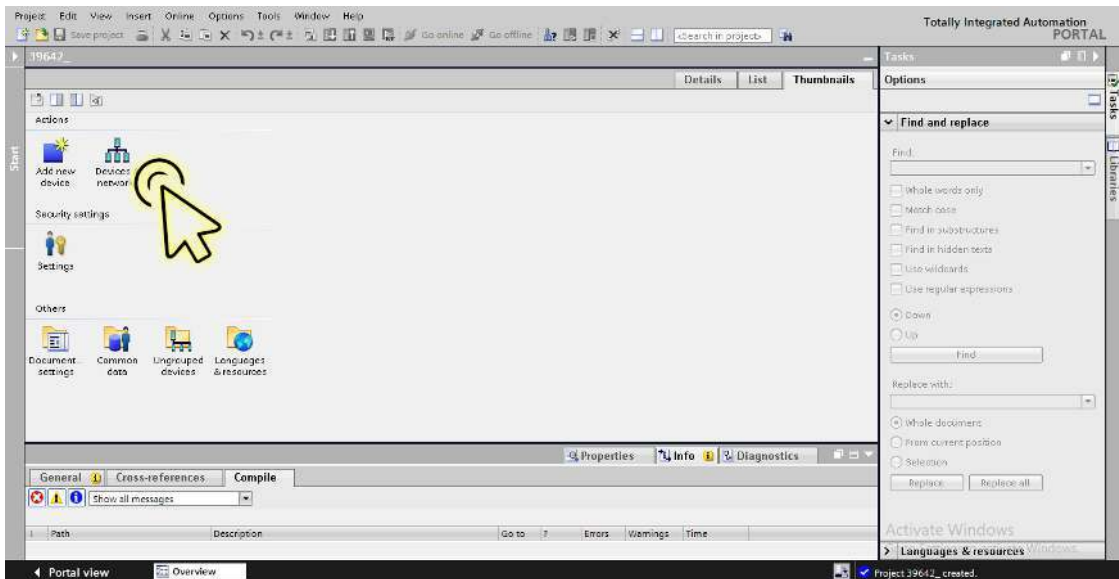

The dialog displays the *Devices & networks* window.

- In the *Network view* tab, click the icon of the device.

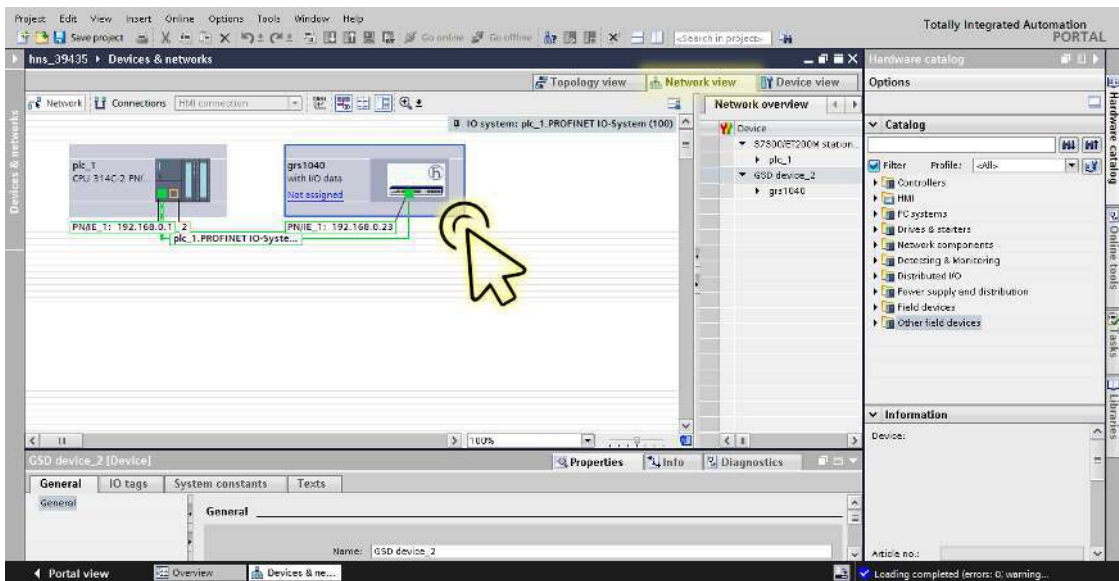

- Assign the device to the PLC.
 - Right-click the *Not assigned* link in the device tile.
 - In the context menu, select the *Assign to new IO controller* item.

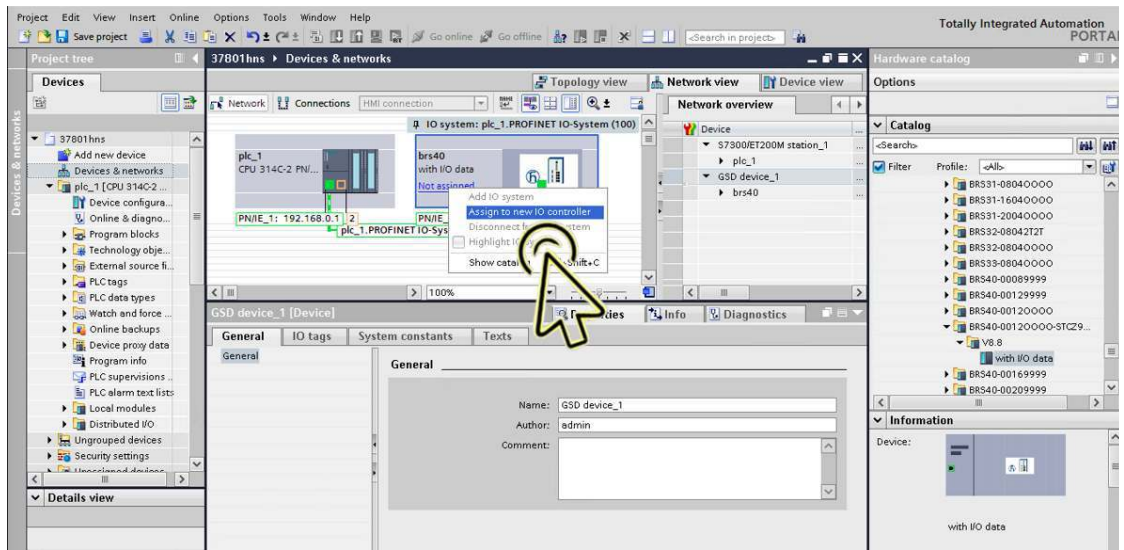

The *Select IO controller* window opens.

- Select the required item, then click the *OK* button.

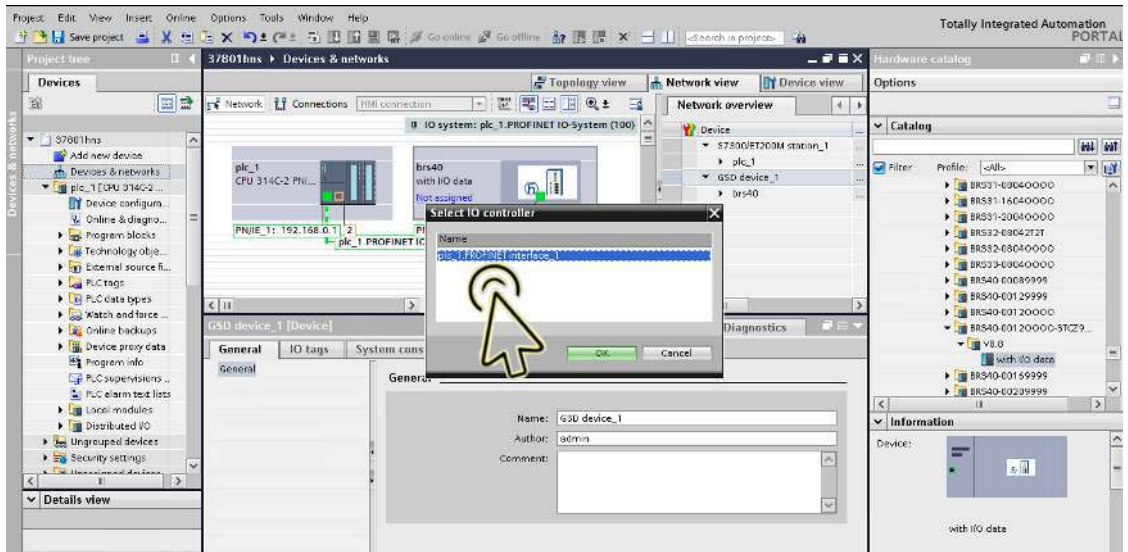

As an alternative, click the *Not assigned* link in the device tile, then select the required item.

- Select the *Device view* tab to display the device details.

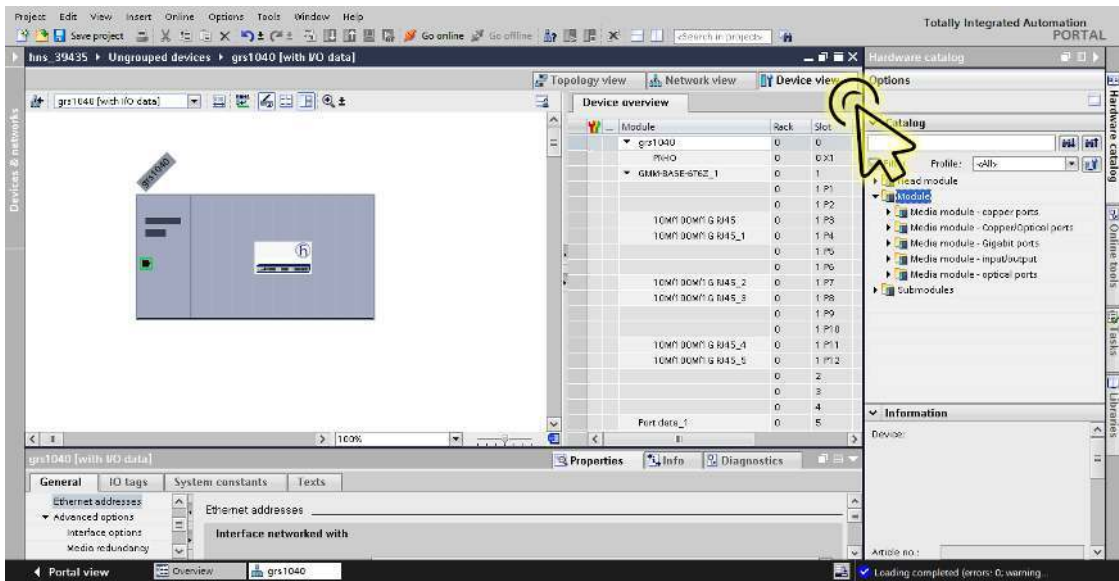

- Select the *Properties* tab.
The *Properties* tab contains additional tabs.

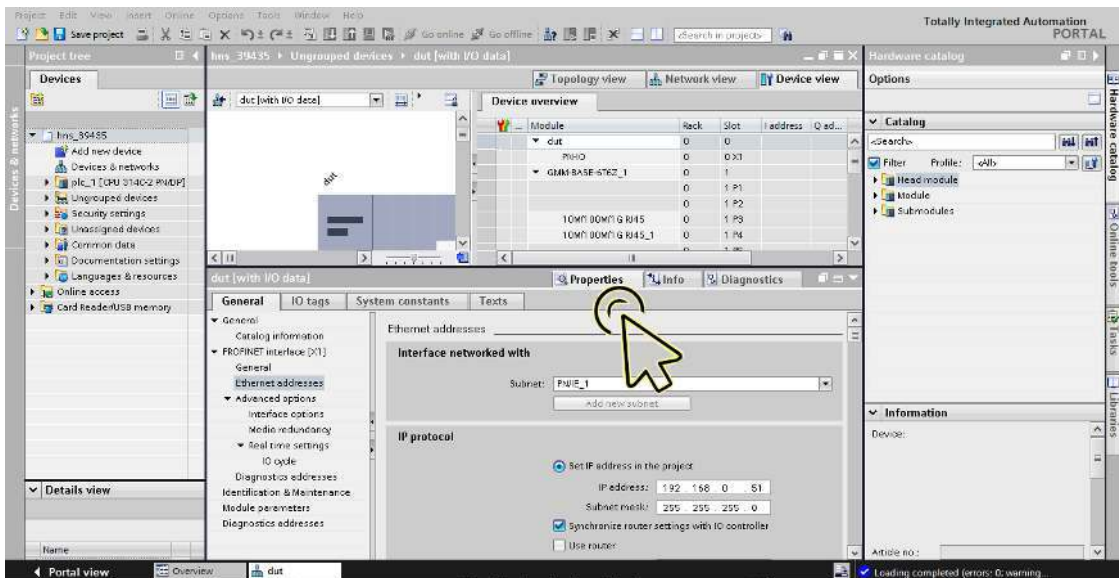

- In the *General* tab, navigate to the *PROFINET interface [X1] > Advanced options > Real time settings > IO cycle* item.

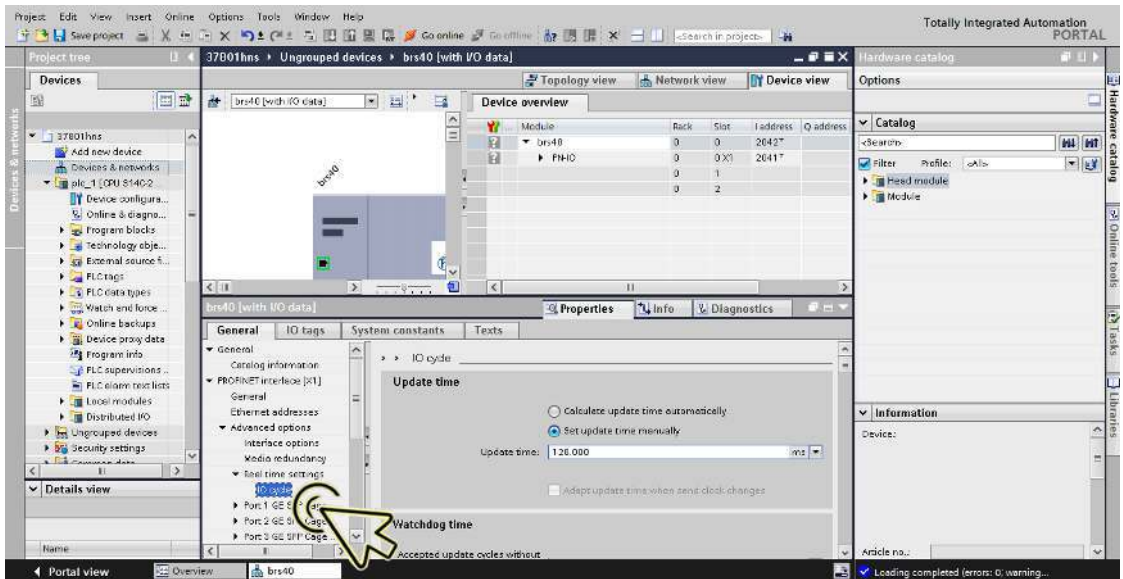

- In the *Update time* frame, select the *Set update time manually* radio button.

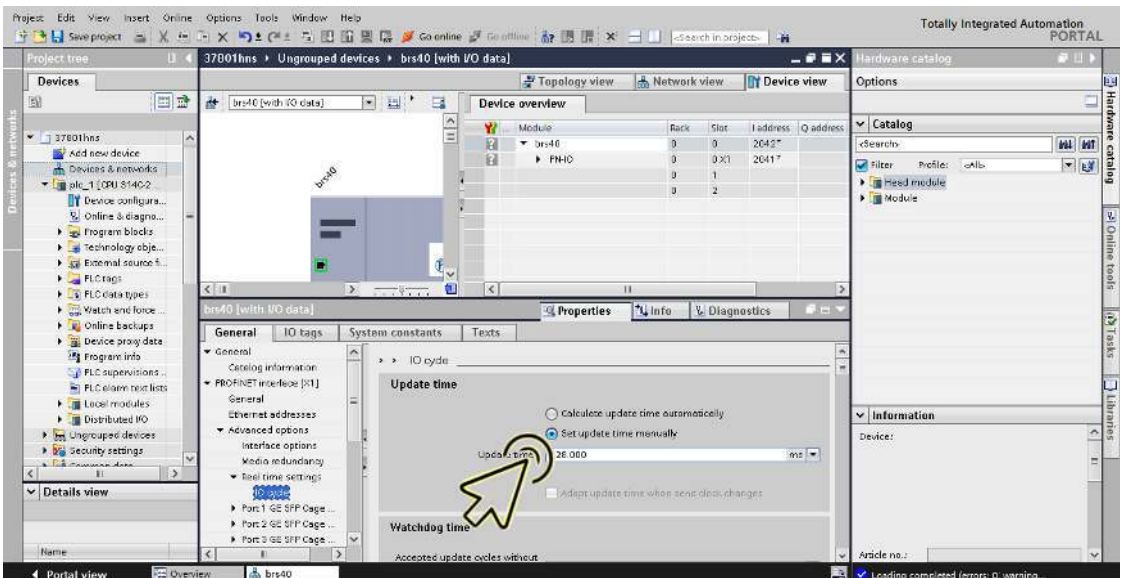

- From the *Update time[ms]* drop-down list, select the desired item.

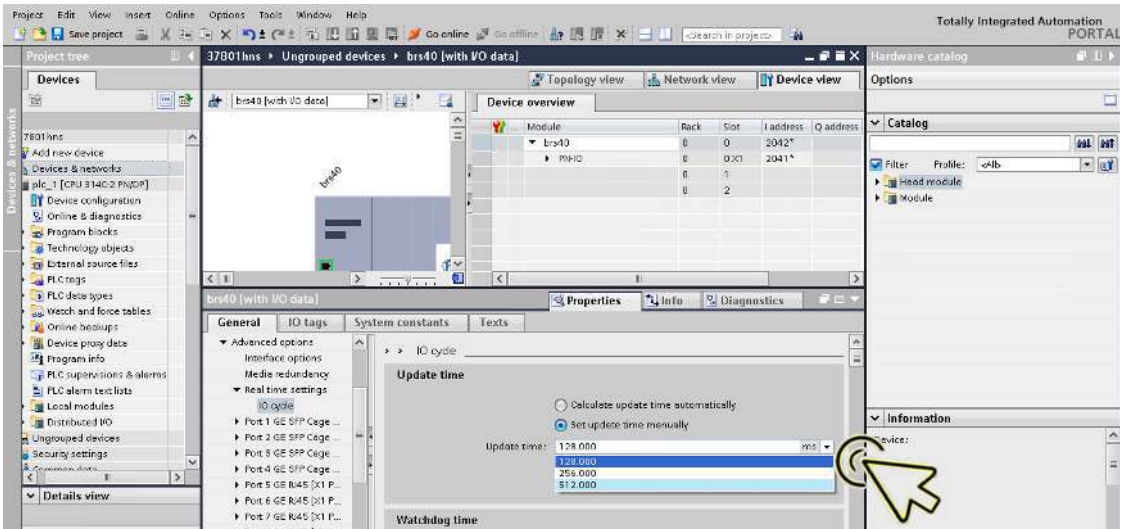

- In the *Watchdog time* frame, select the desired item from the *Accepted update cycles without IO data* drop-down list.

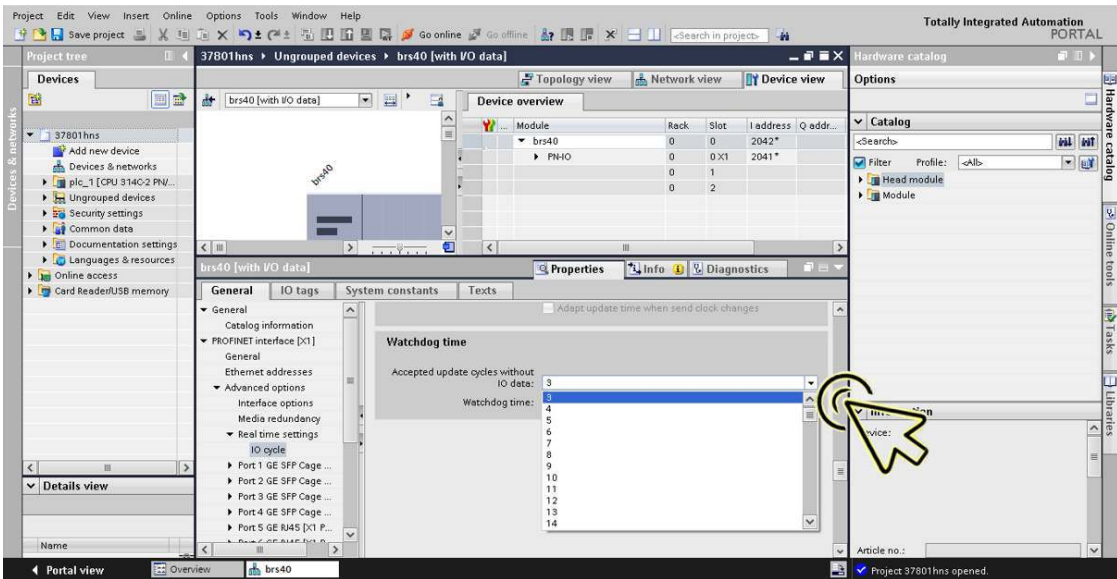

- Click the *Save project* button.

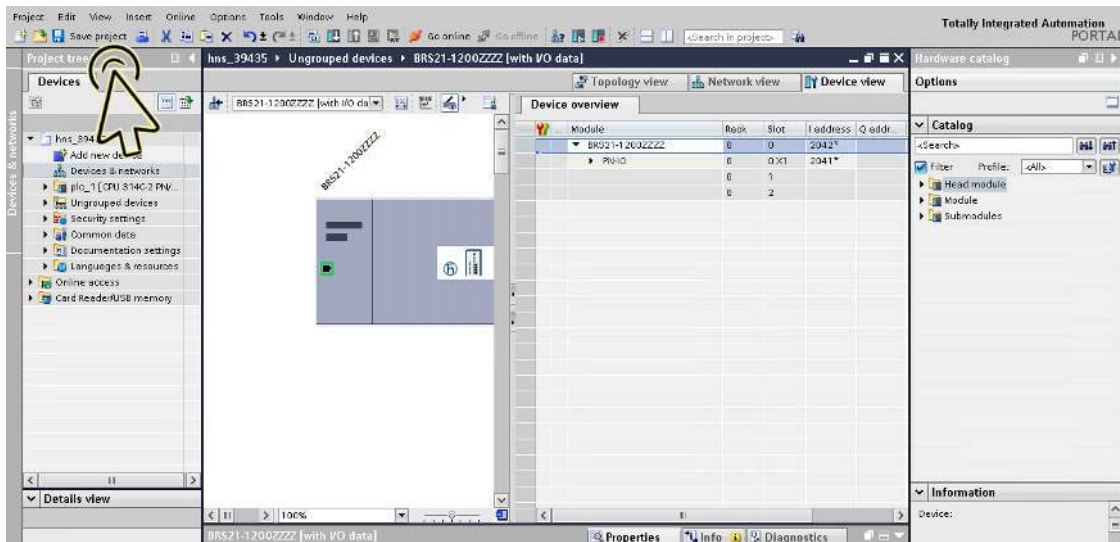

Setting up Media Redundancy

Perform the following steps:

- Click the *Project view* icon.

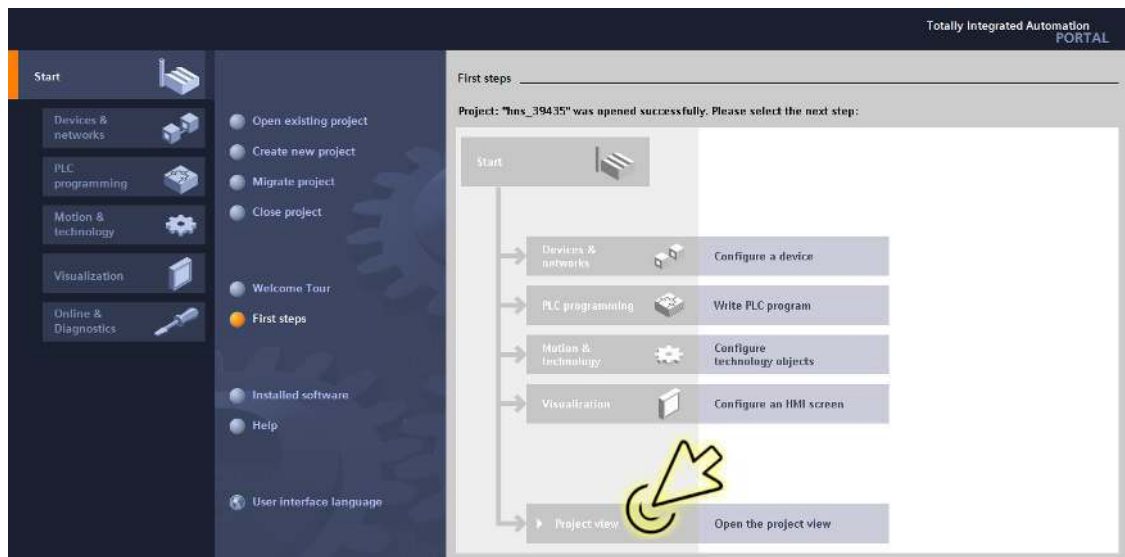

The dialog displays the *Project view* window.

- Click the *Overview* tab in the footer.

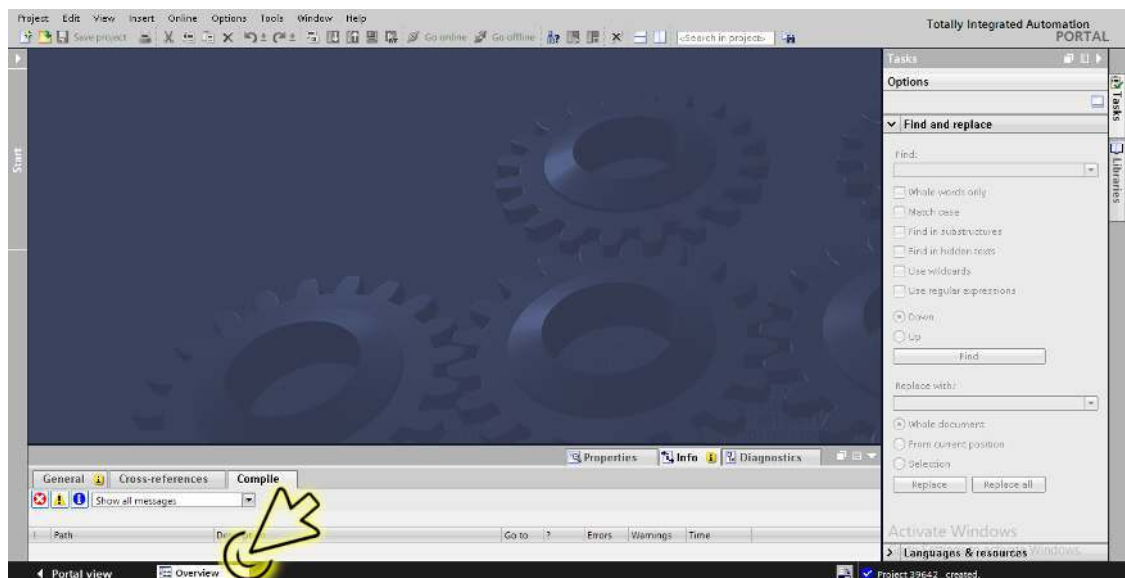

The dialog displays the *Overview* window.

- Double-click the *Devices & networks* icon.

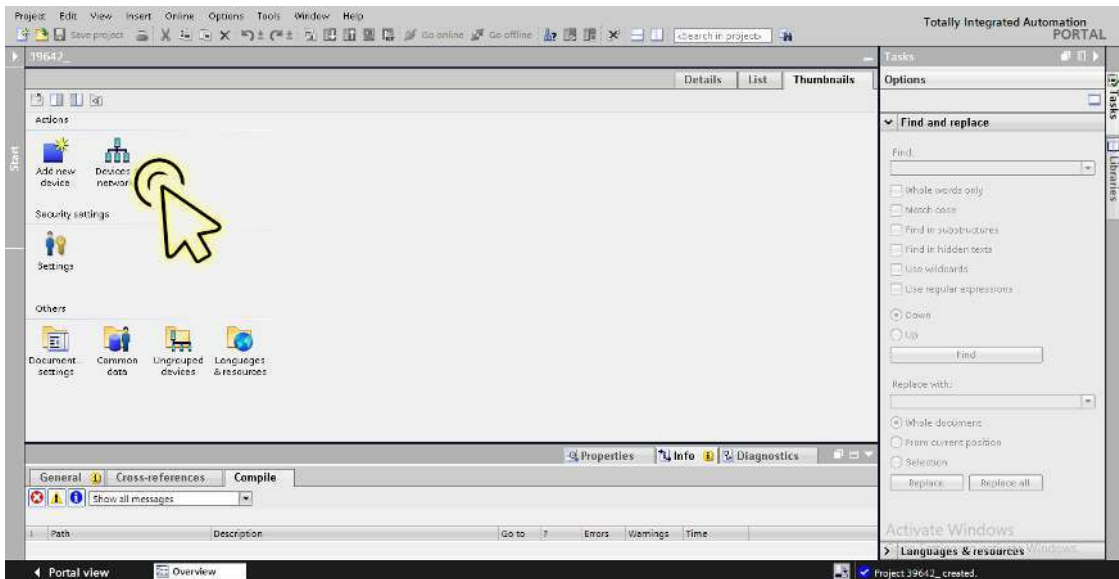

The dialog displays the *Devices & networks* window.

- In the *Network view* tab, click the icon of the device.

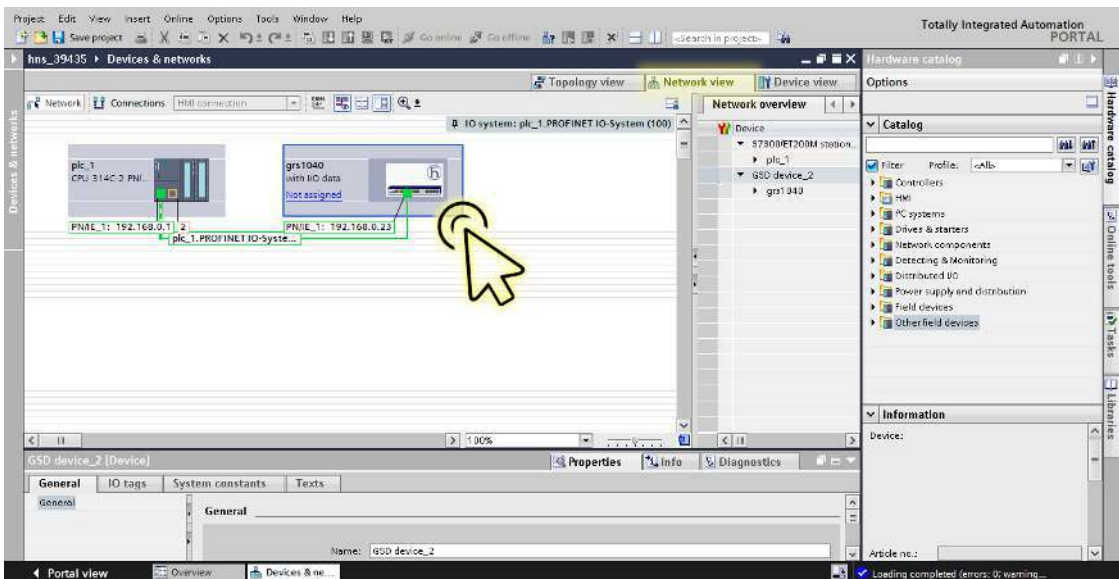

- Select the *Device view* tab to display the device details.

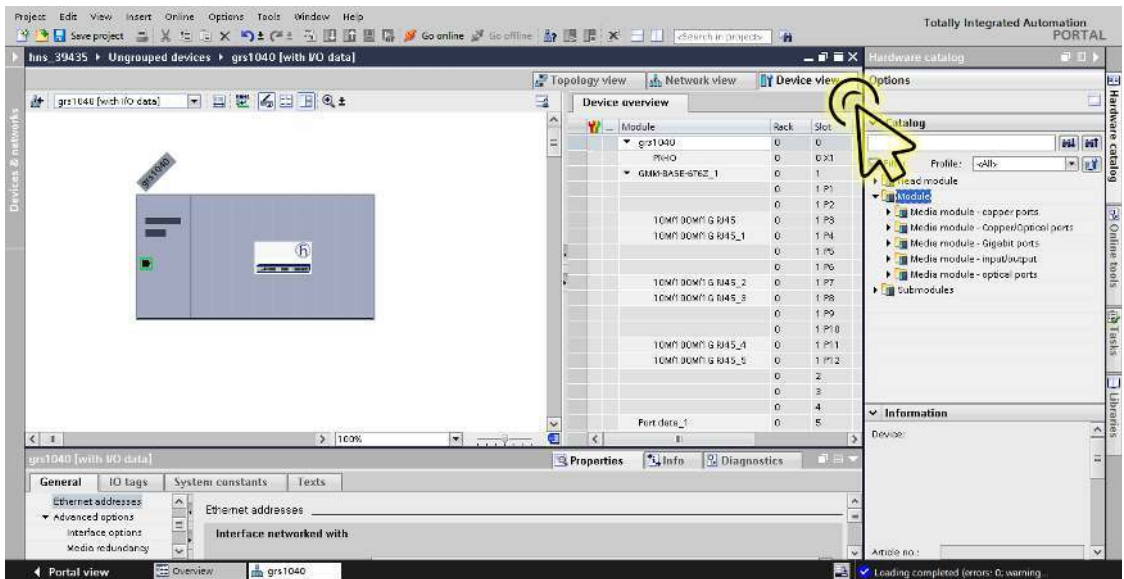

- Select the *Properties* tab.
The *Properties* tab contains additional tabs.

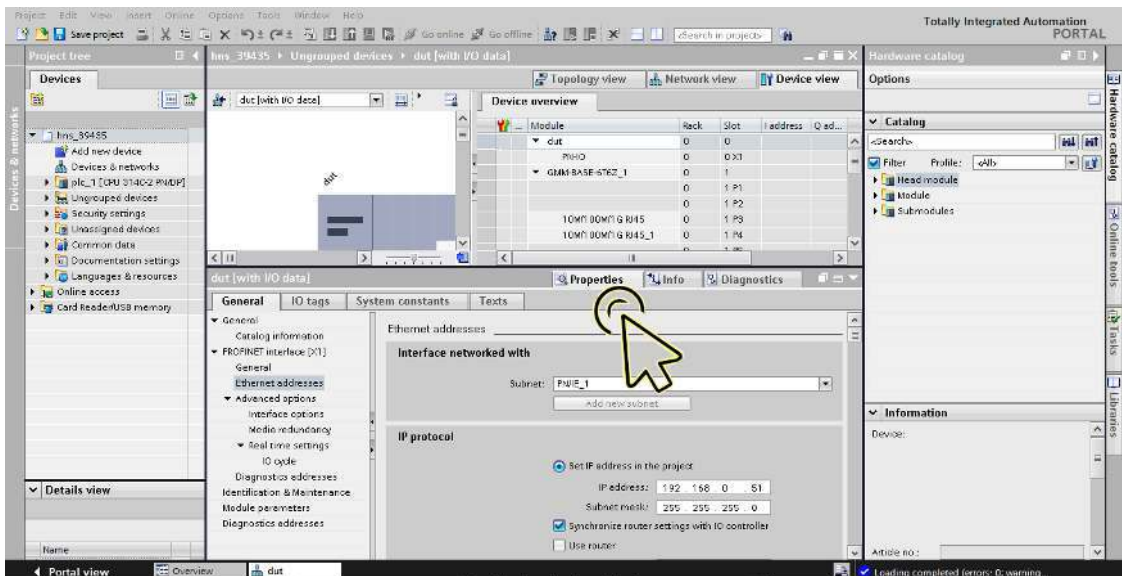

- In the **General** tab, navigate to the **PROFINET interface [X1] > Advanced options > Media redundancy** item.

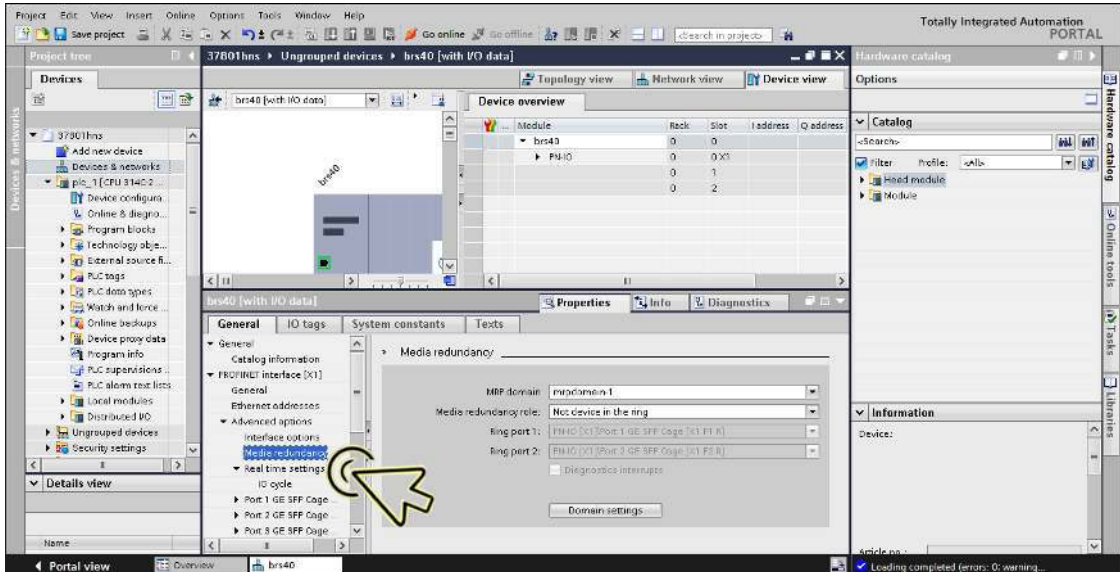

- From the **Media redundancy role** drop-down list, select the desired item.

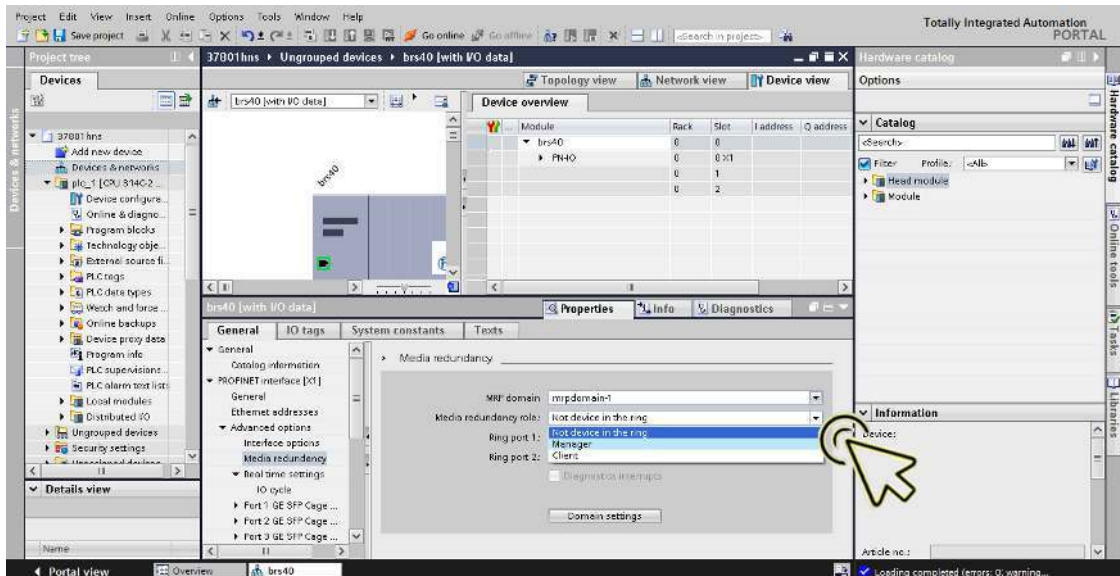

- From the **Ring port 1** drop-down list, select the desired item.

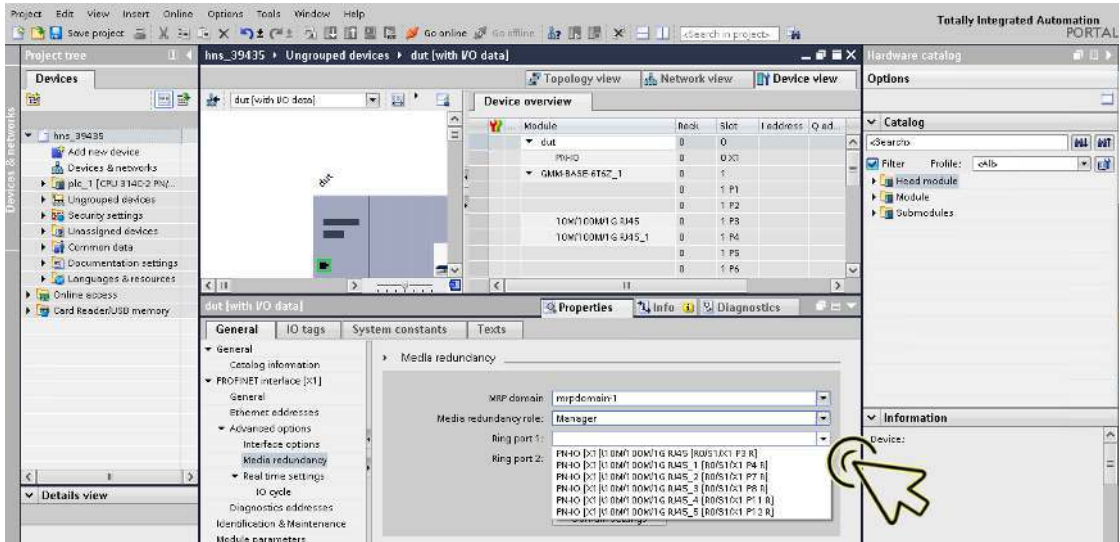

- From the *Ring port 2* drop-down list, select the desired item.

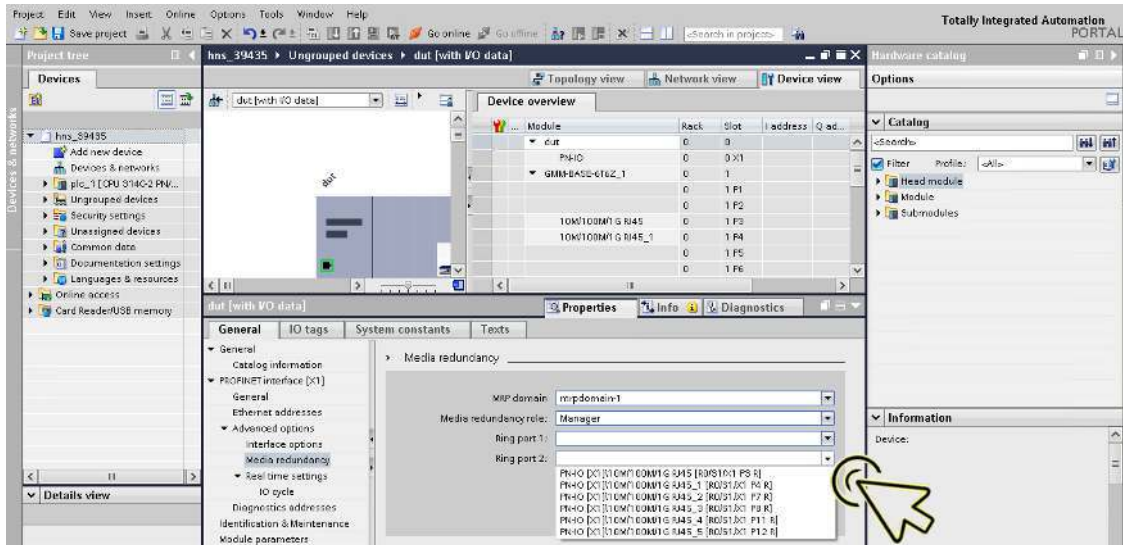

- Mark the *Diagnostics interrupts* checkbox to receive MRP ring Open/Close alarms.

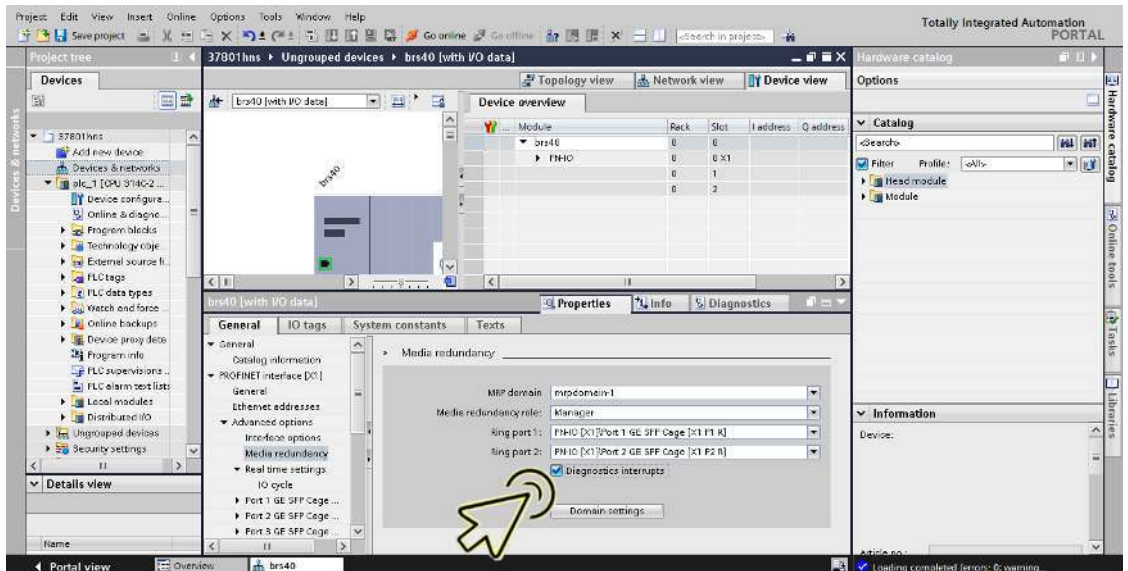

- Click the *Save project* button.

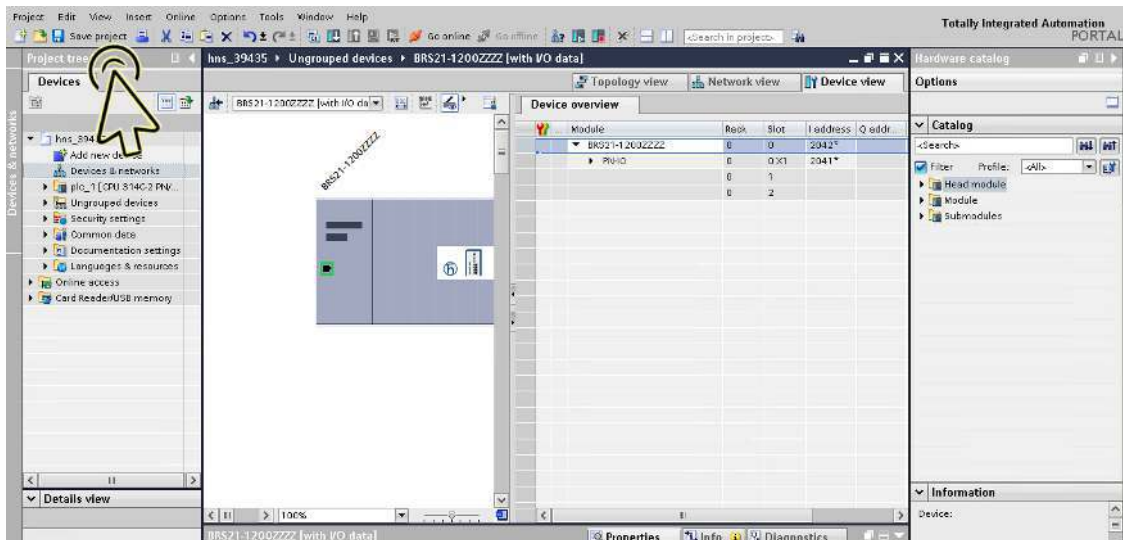

Note: When an Application Relation is already established, do not disable any of the MRP Ring ports using the I/O modules (PROFINET).

Adding modules for modular devices

Perform the following steps:

- Click the *Project view* icon.

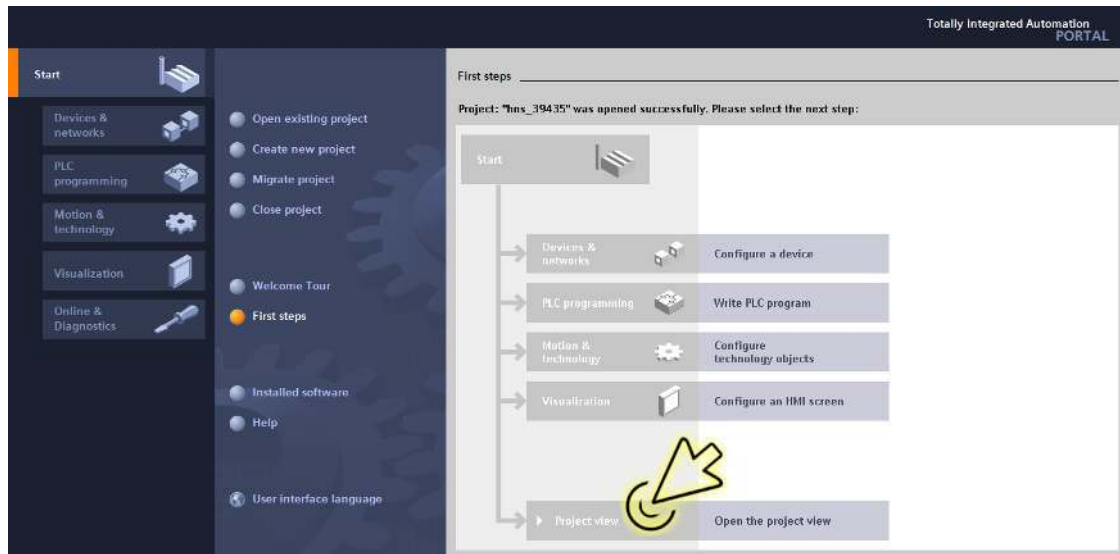

The dialog displays the *Project view* window.

- Click the *Overview* tab in the footer.

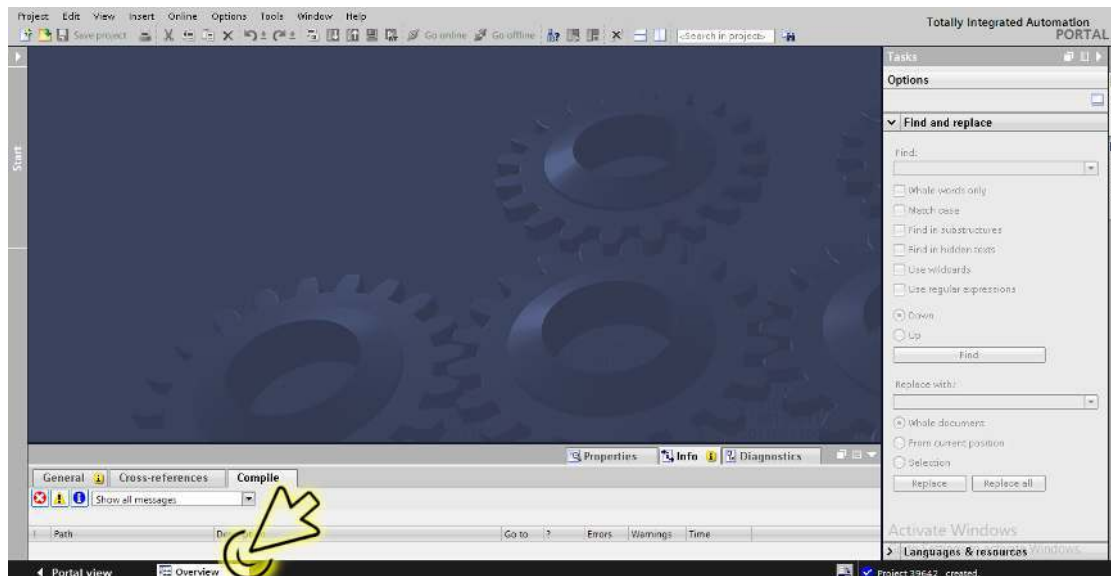

The dialog displays the *Overview* window.

- Double-click the *Devices & networks* icon.

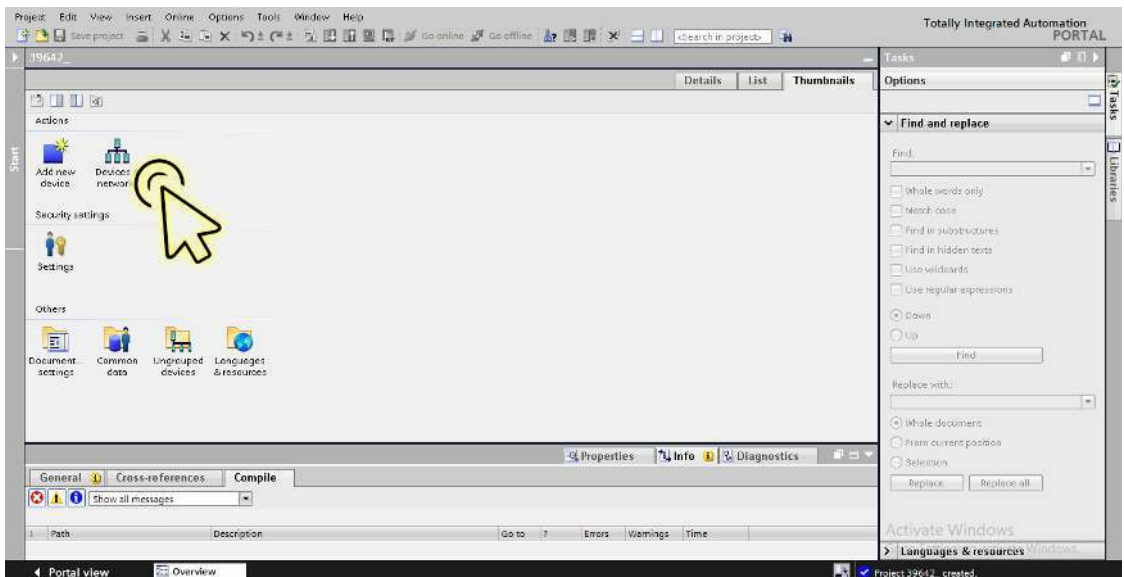

The dialog displays the *Devices & networks* window.

- Select the *Network view* tab.
- Click the icon of the device that is under test.

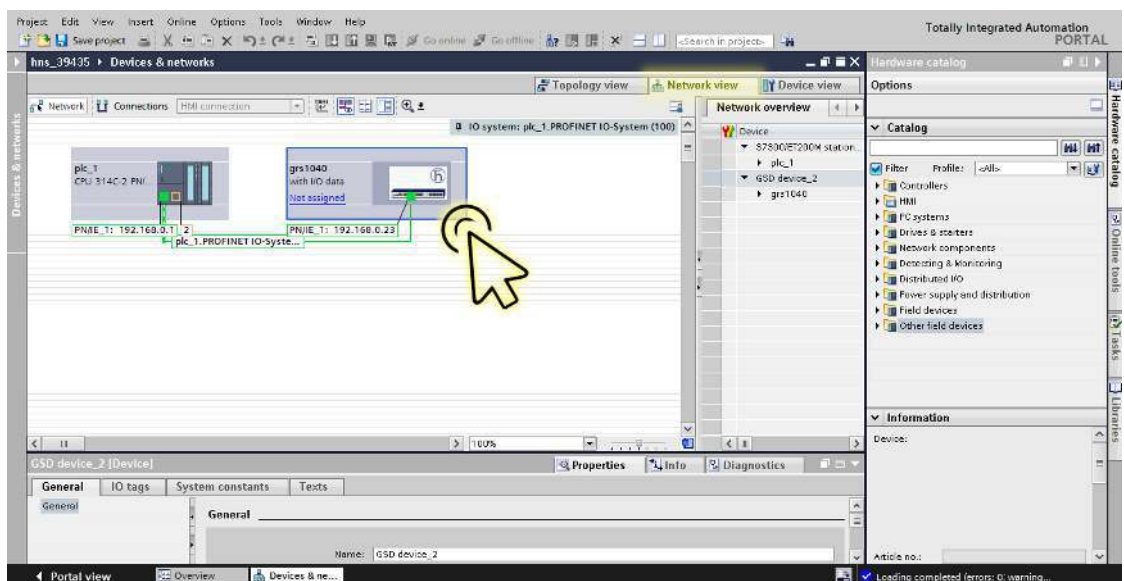

- Select the *Device view* tab to display the device details.

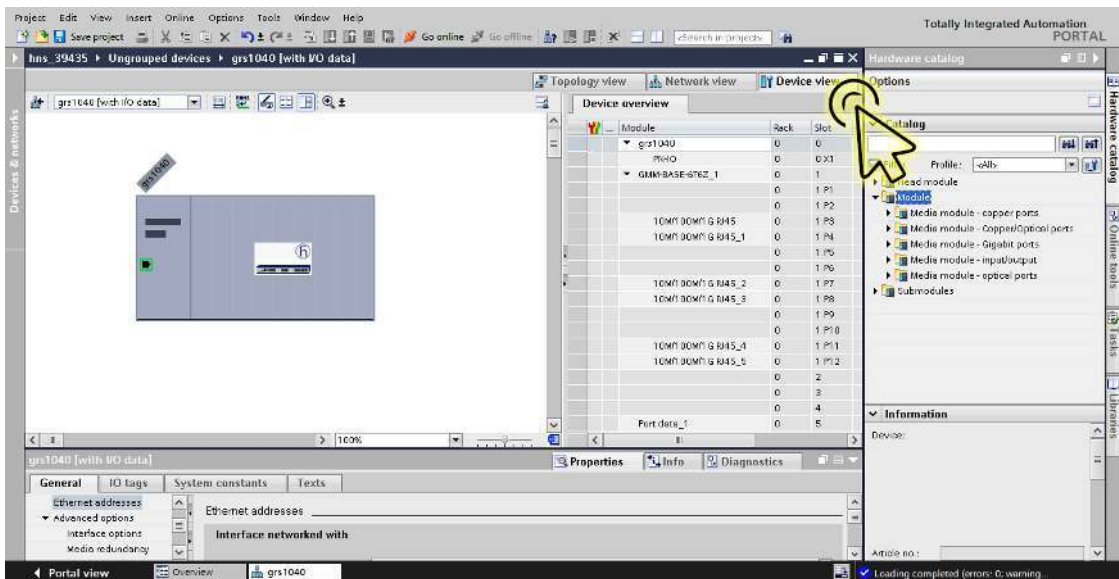

- Select the *Hardware catalog* tab in the right margin to display the *Catalog* pod.

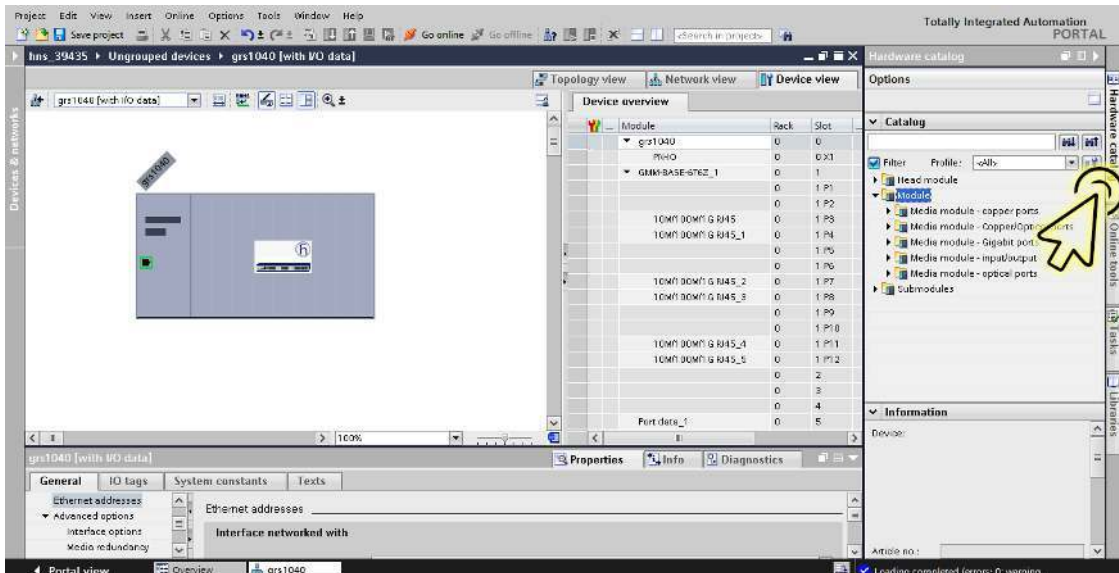

The tree view displays the available media modules.

- In the tree view, select the required module.

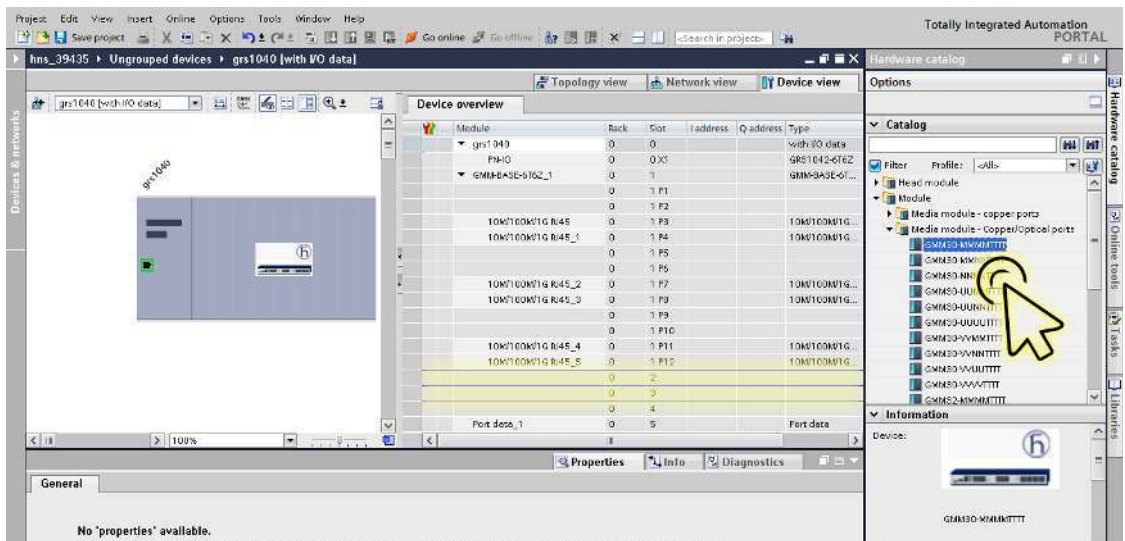

In the *Device view* tab, the slot which is physically connected to the device is highlighted.

- Drag the selected module, and drop it onto the highlighted slot in the *Device view* tab.

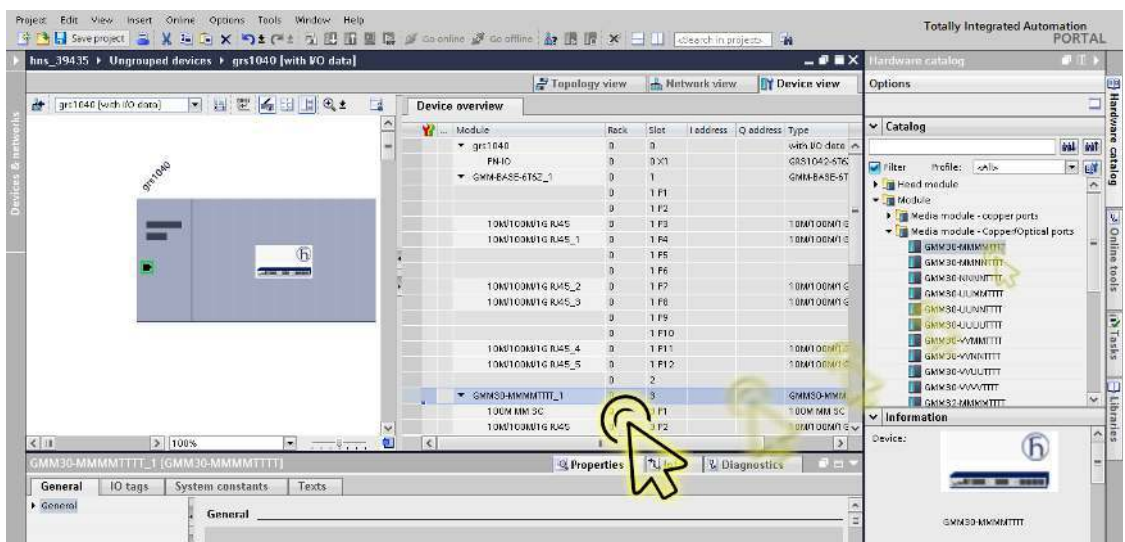

Note: The TIA Portal automatically adds the *fixed ports* when you add a module in the *Device view* tab. If the module has SFP slots, you need to set up the SFPs. See section “Adding an SFP transceiver as a submodule in non-modular devices” on page 330.

Adding digital I/O modules in non-modular devices

In non-modular devices, *device data* modules and *port data* modules are available that transfer the I/O data packets in the *PROFINET* network. For inserting a *device data* module or *port data* module, perform the following steps:

- Click the *Project view* icon.

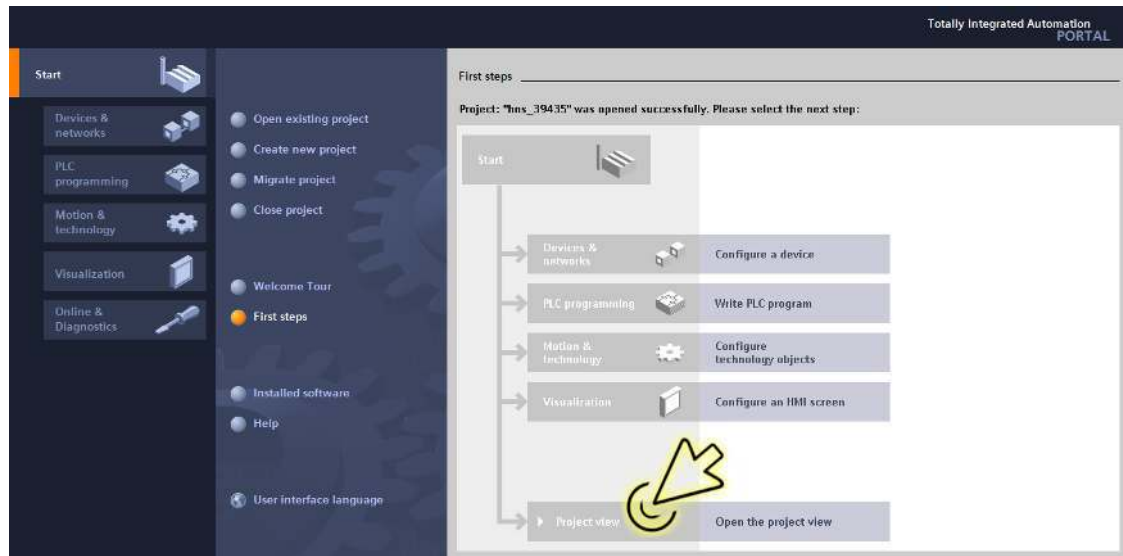

The dialog displays the *Project view* window.

- Click the *Overview* tab in the footer.

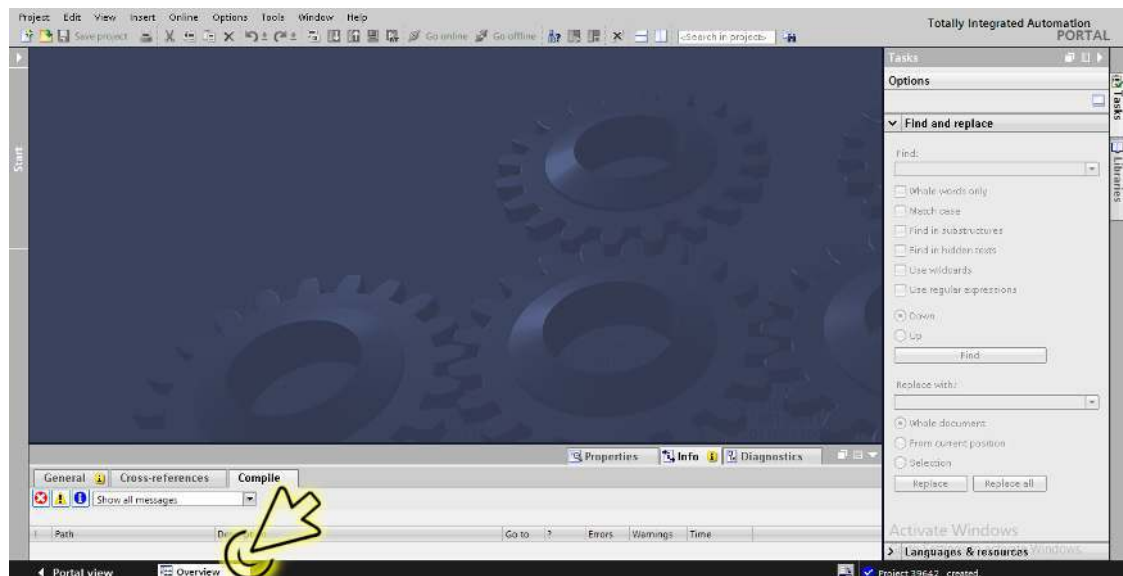

The dialog displays the *Overview* window.

- Double-click the *Devices & networks* icon.

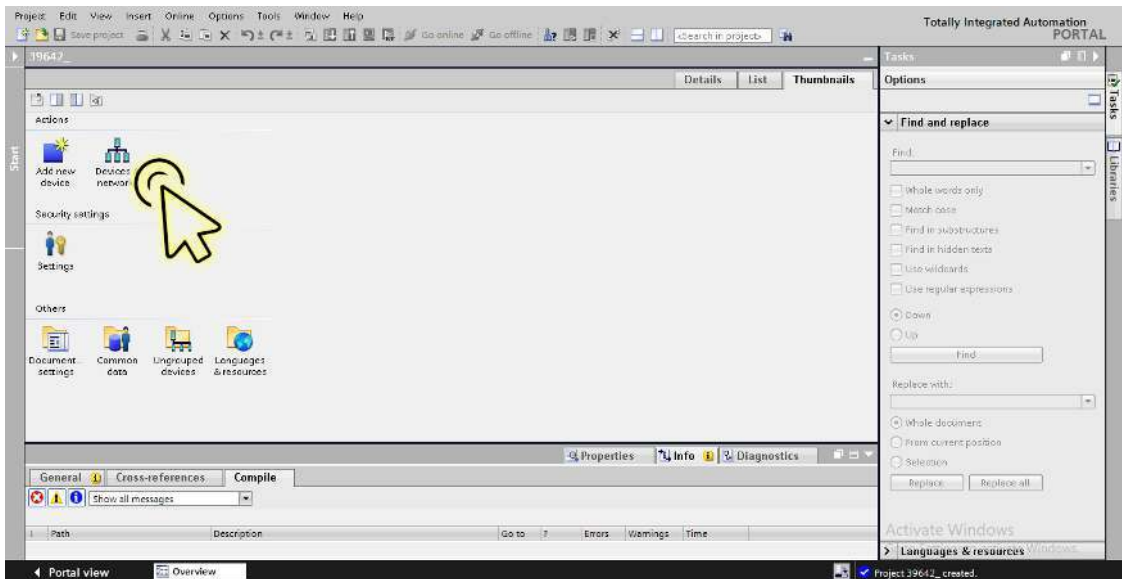

The dialog displays the *Devices & networks* window.

- In the *Network view* tab, click the icon of the device.

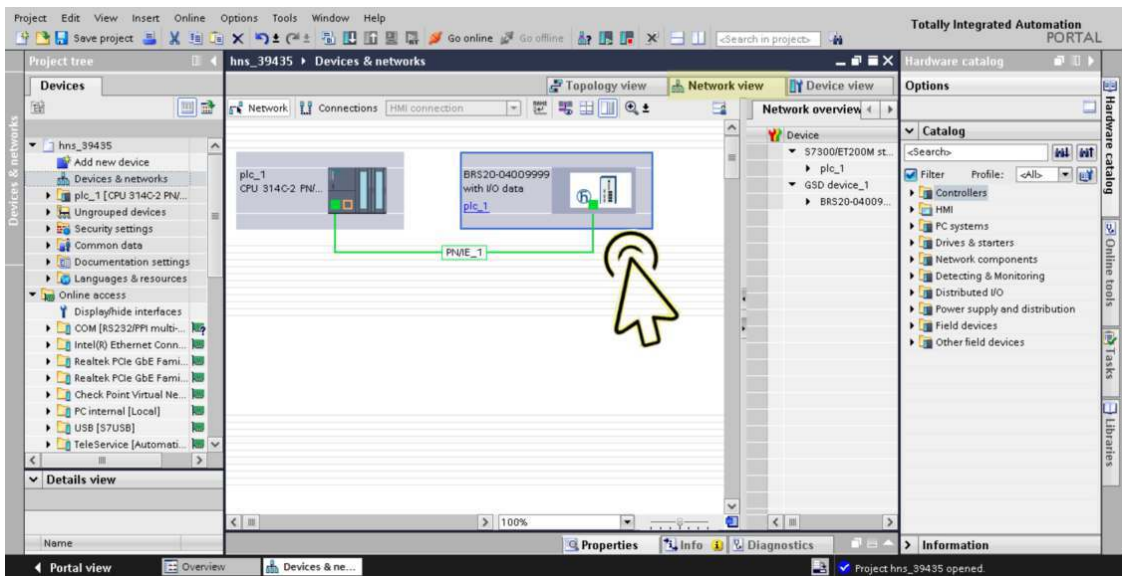

- Select the *Device view* tab to display the device details.

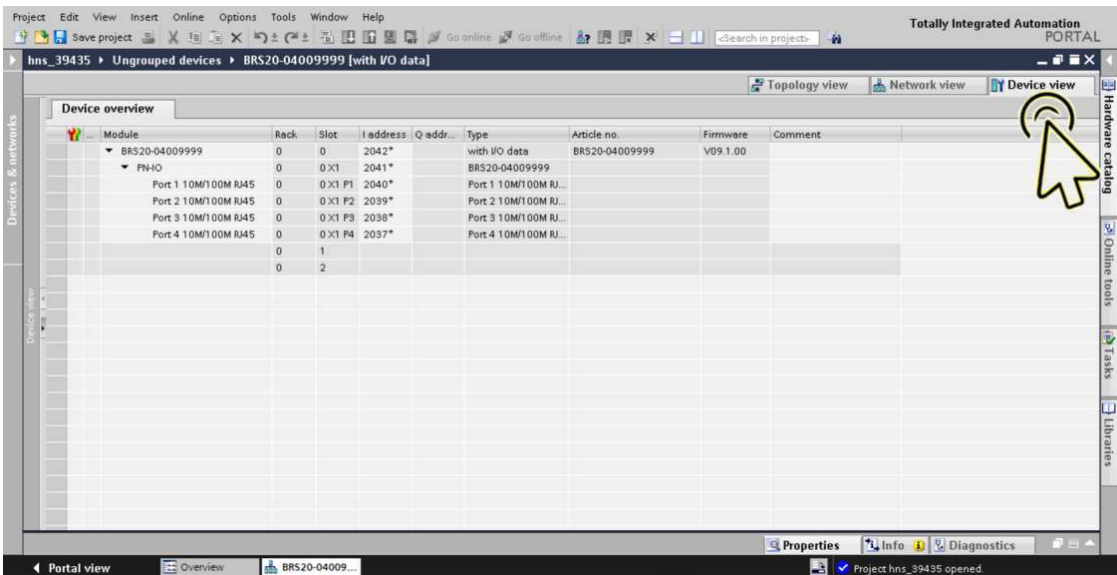

- Select the *Hardware catalog* tab in the right margin to display the available media modules.

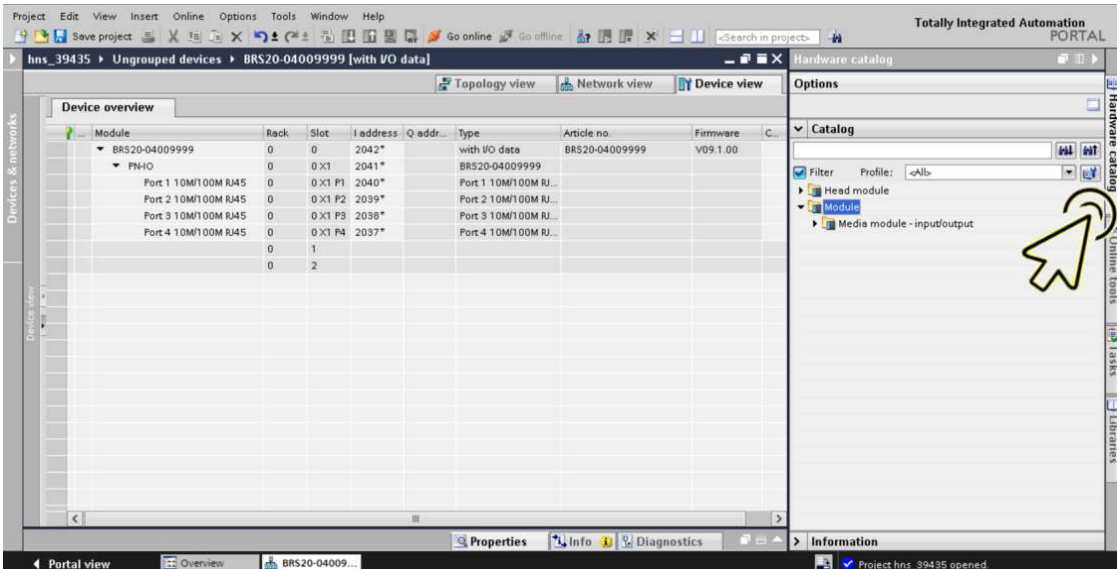

- Select the required *Device data* module or *Port data* module.

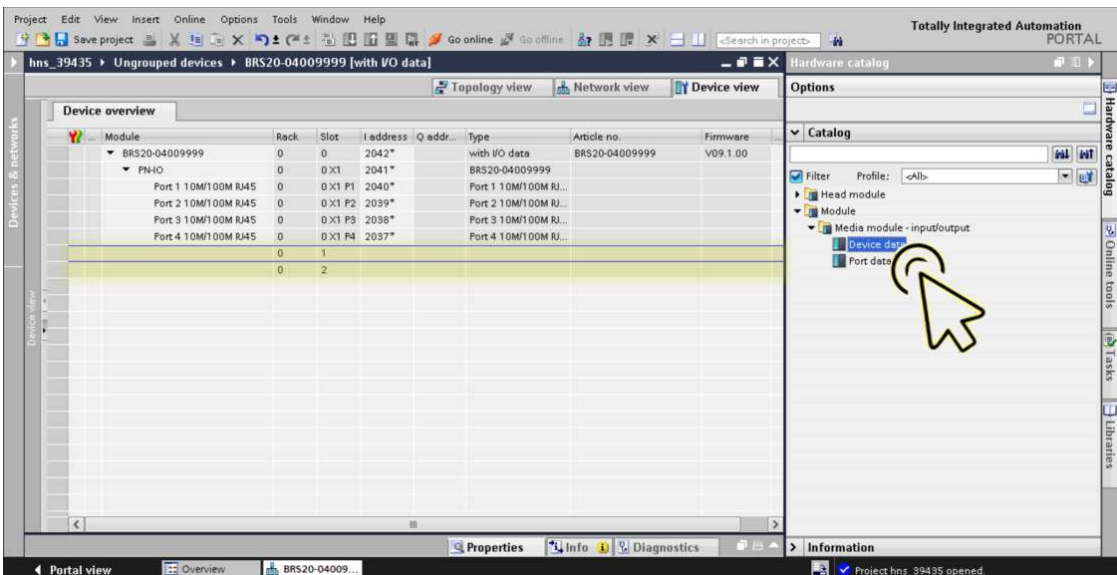

In the *Device view* tab, the slot which is logically connected to the device is highlighted.

- Drag the selected module, and drop it onto the highlighted slot in the *Device view* tab.

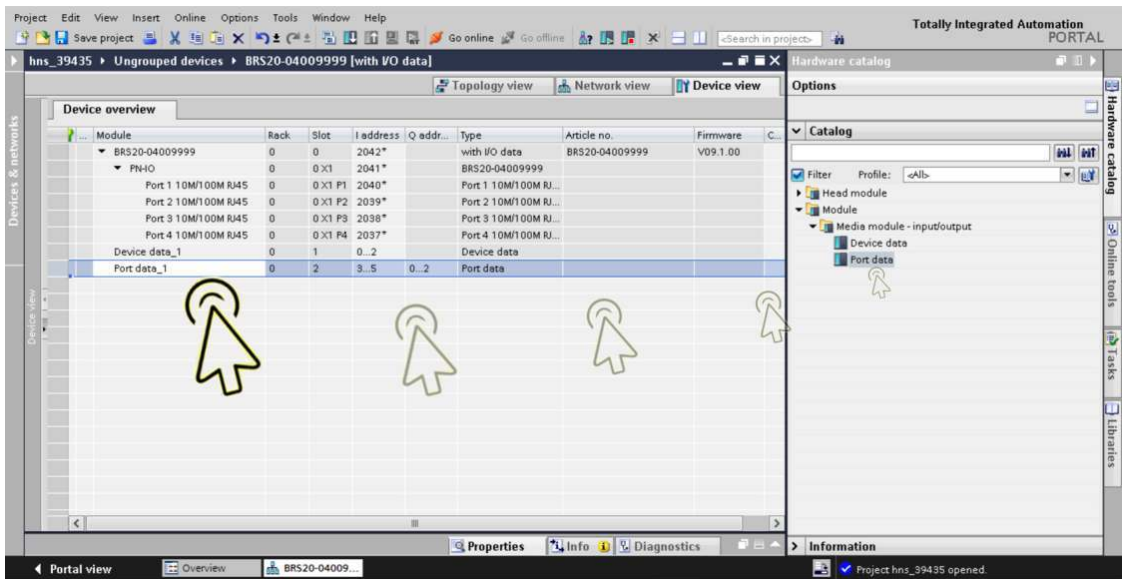

- Click the *Save project* icon.

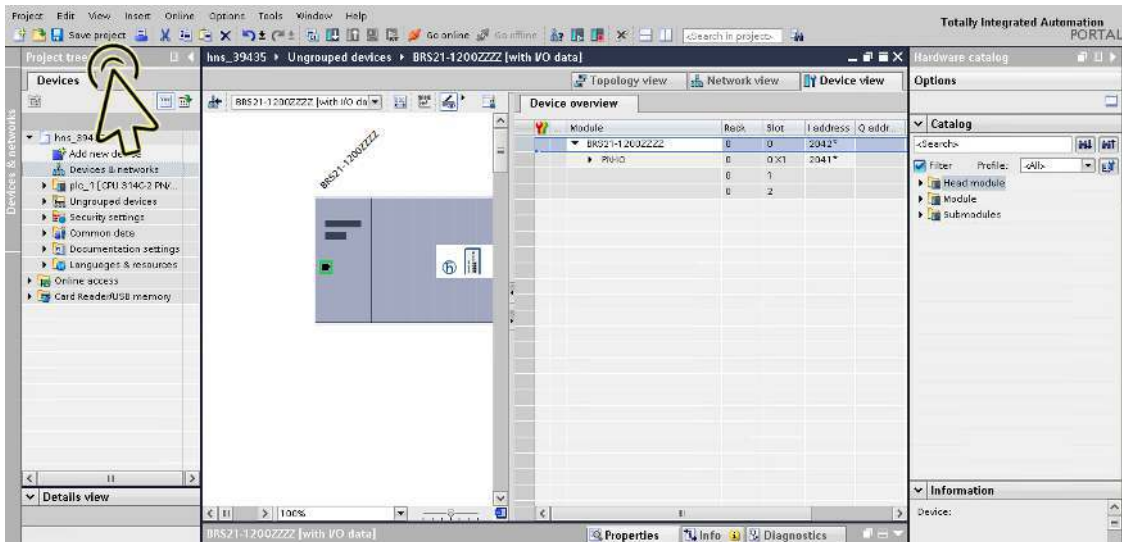

Adding digital I/O modules in modular devices

In modular devices, *device data* modules and *port data* modules are available that transfer the I/O data packets in the *PROFINET* network. For inserting a *device data* module or *port data* module, perform the following steps:

- Click the *Project view* icon.

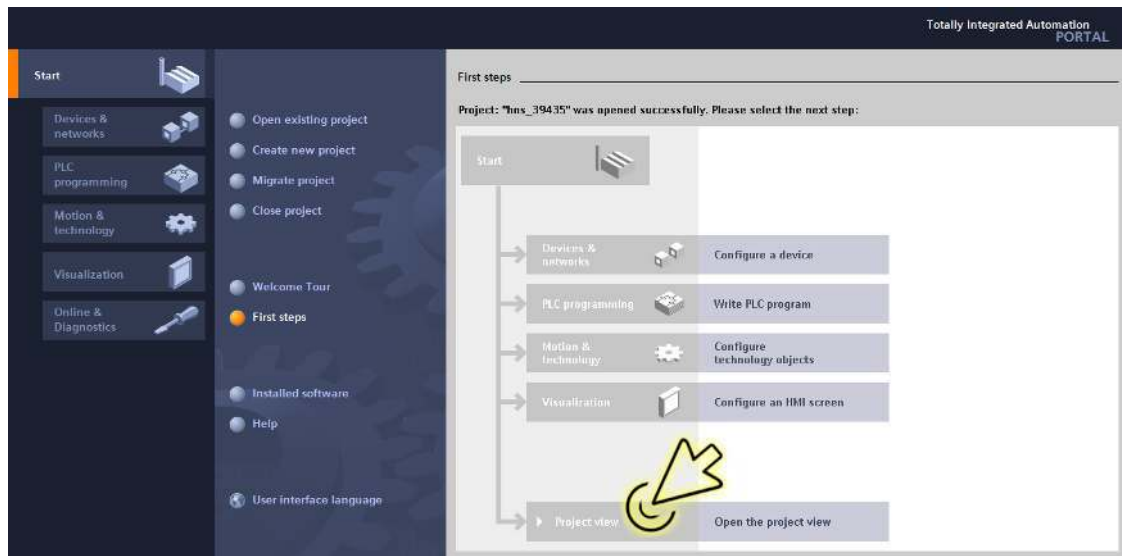

The dialog displays the *Project view* window.

- Click the *Overview* tab in the footer.

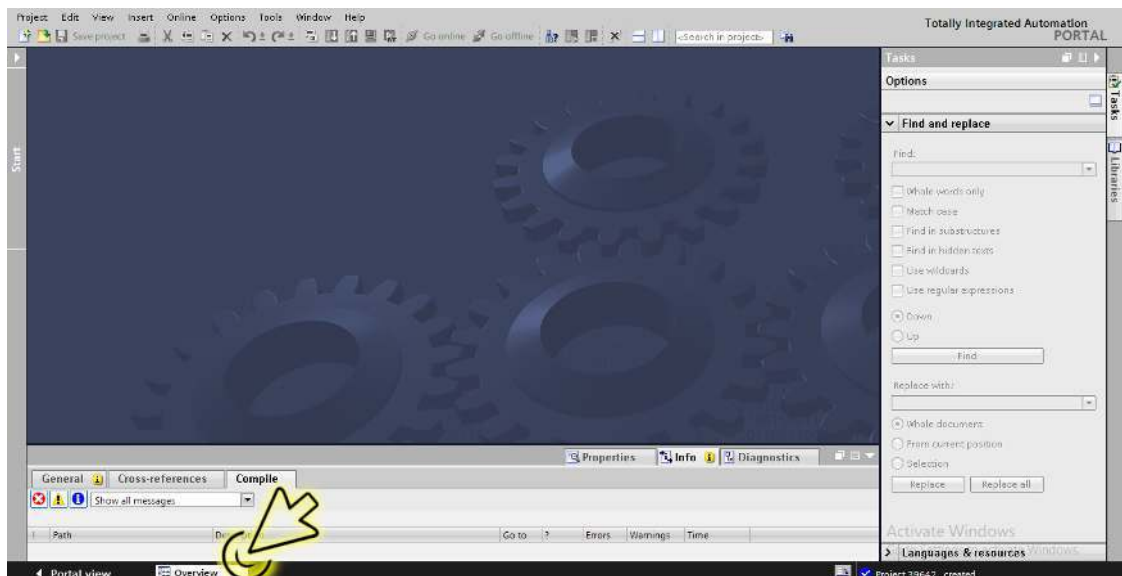

The dialog displays the *Overview* window.

- Double-click the *Devices & networks* icon.

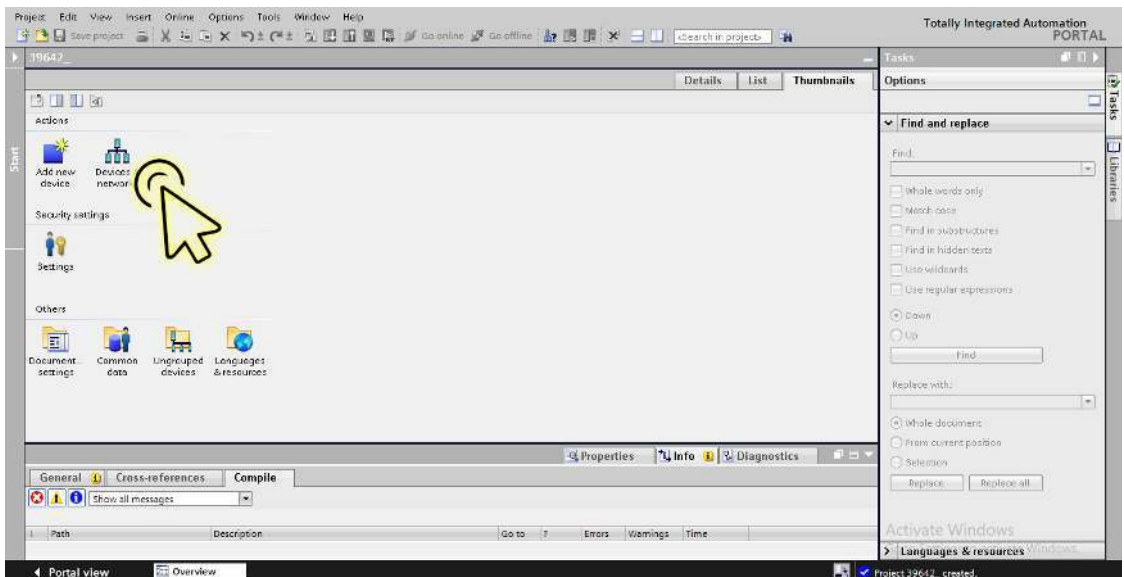

The dialog displays the *Devices & networks* window.

- Select the *Device view* tab to display the device details.

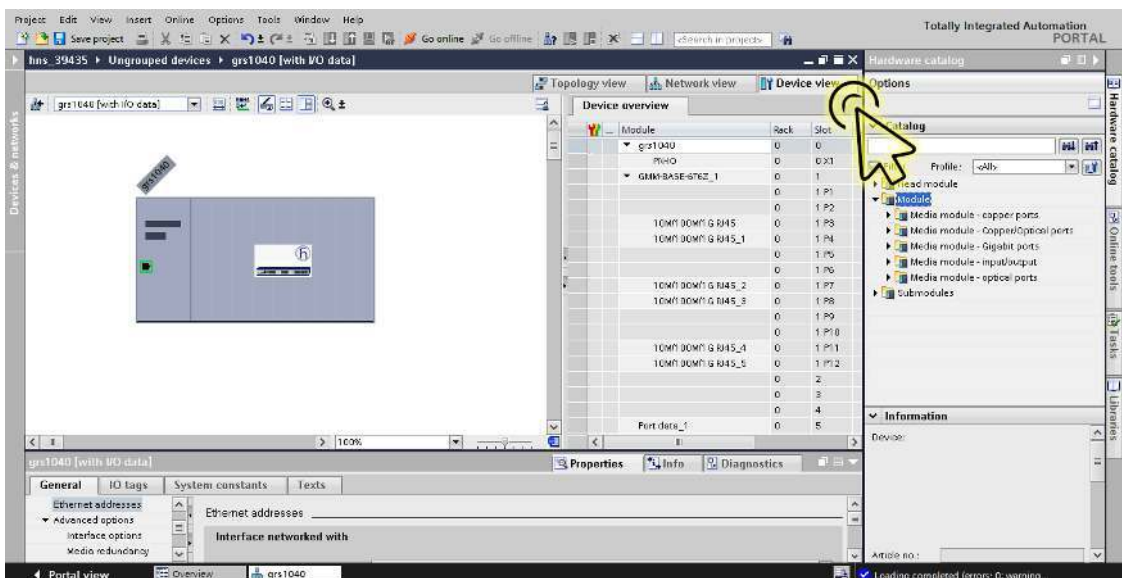

- Select the *Hardware catalog* tab in the right margin to display the *Catalog* pod.

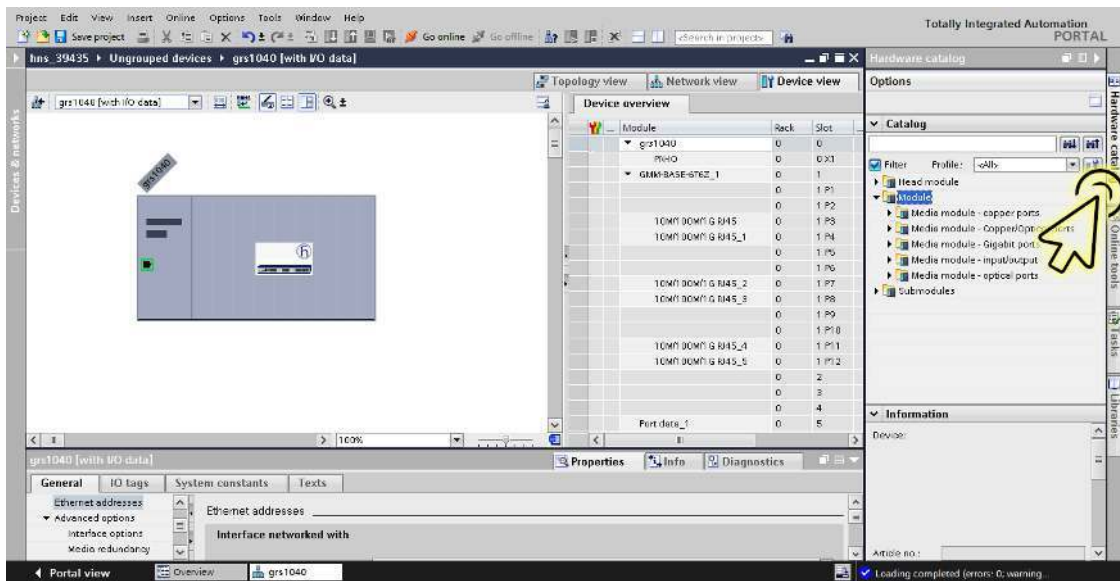

The tree view displays the available media modules.

- In the tree view, *Media module - input/output* branch, select the required *device data* module or *port data* module.

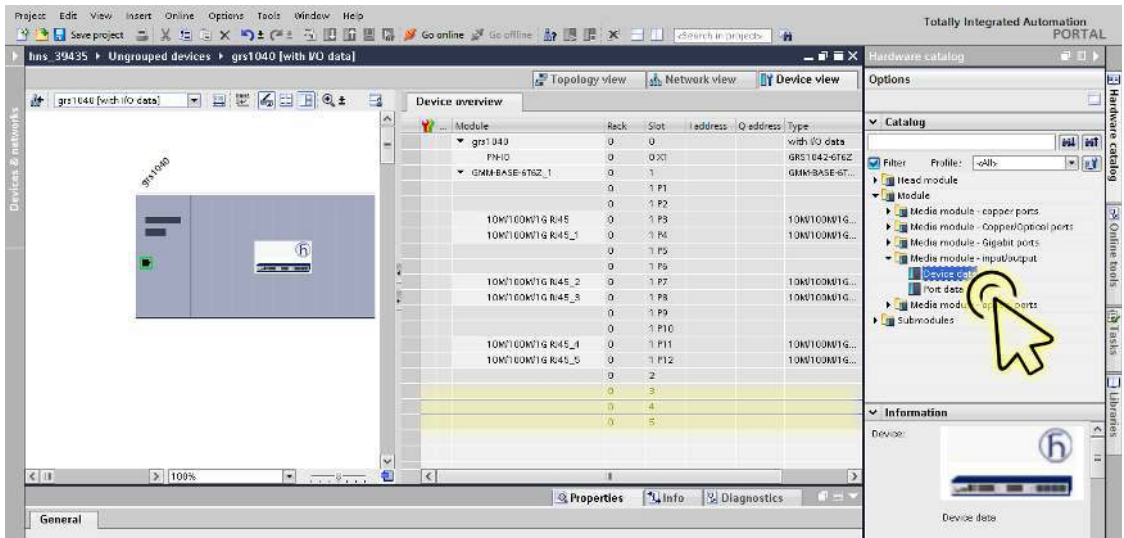

In the *Device view* tab, the slot which is logically connected to the device is highlighted.

- Drag the selected module, and drop it onto the highlighted slot in the *Device view* tab.

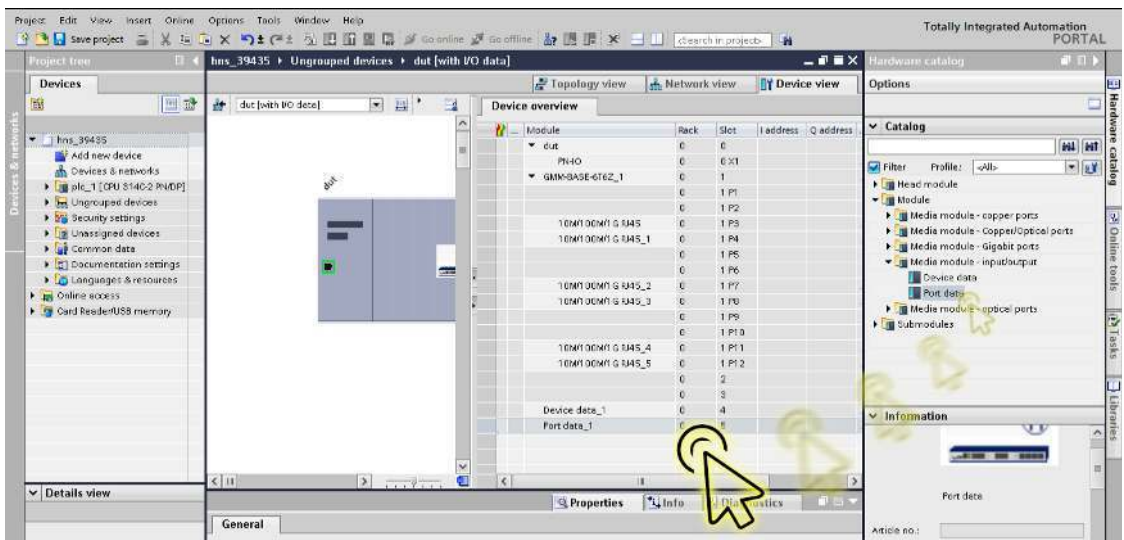

Adding an SFP transceiver as a submodule in non-modular devices

In the TIA Portal, you can set up SFP (Small Form-factor Pluggable) transceivers as submodules in the free SFP slots of the device representation. To set up an SFP submodule, perform the following steps:

- Click the *Project view* icon.

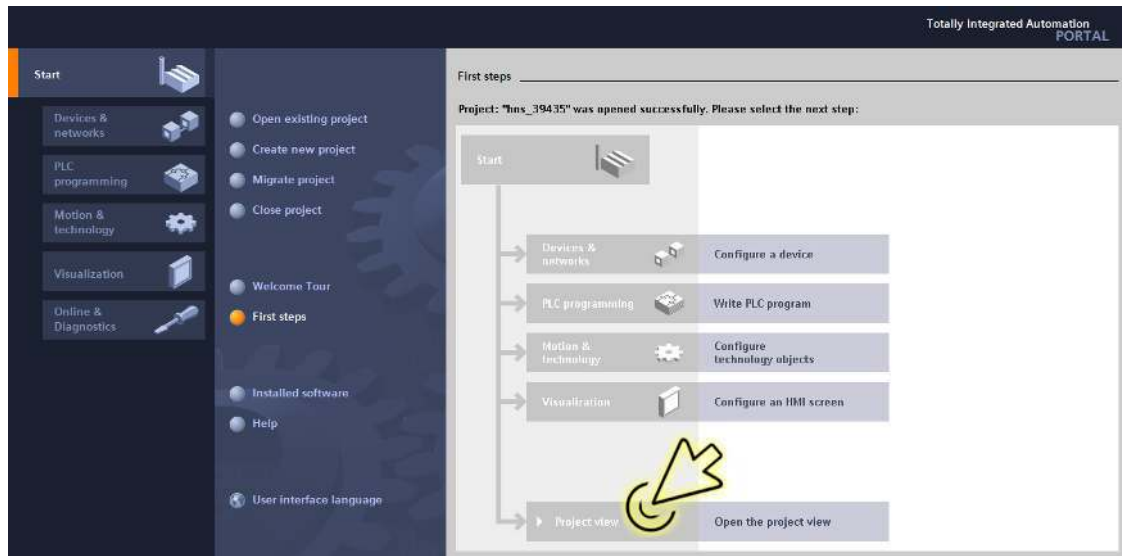

The dialog displays the *Project view* window.

- Click the *Overview* tab in the footer.

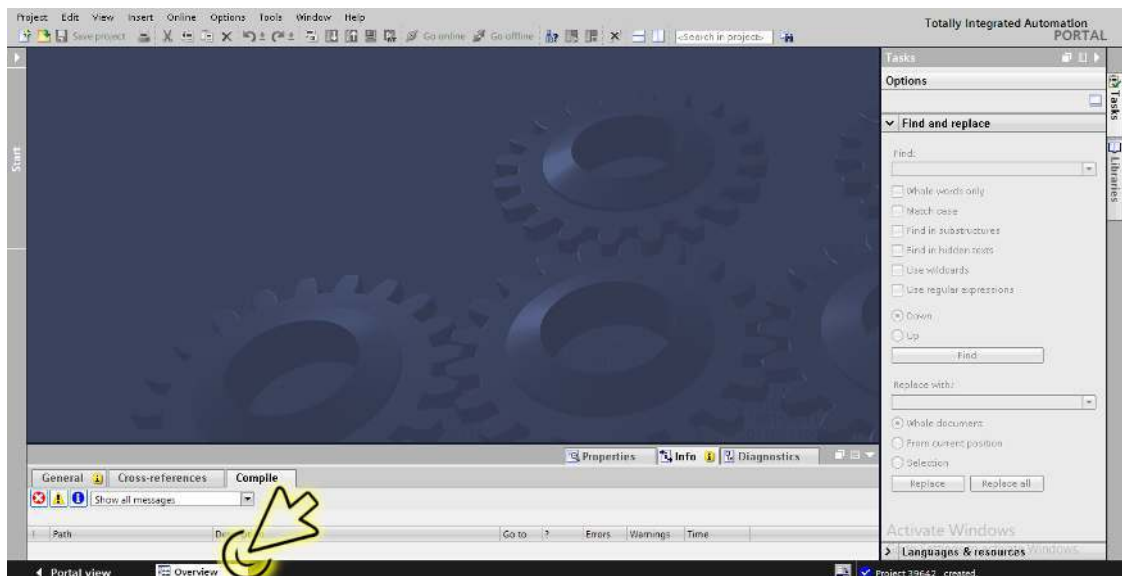

The dialog displays the *Overview* window.

- Double-click the *Devices & networks* icon.

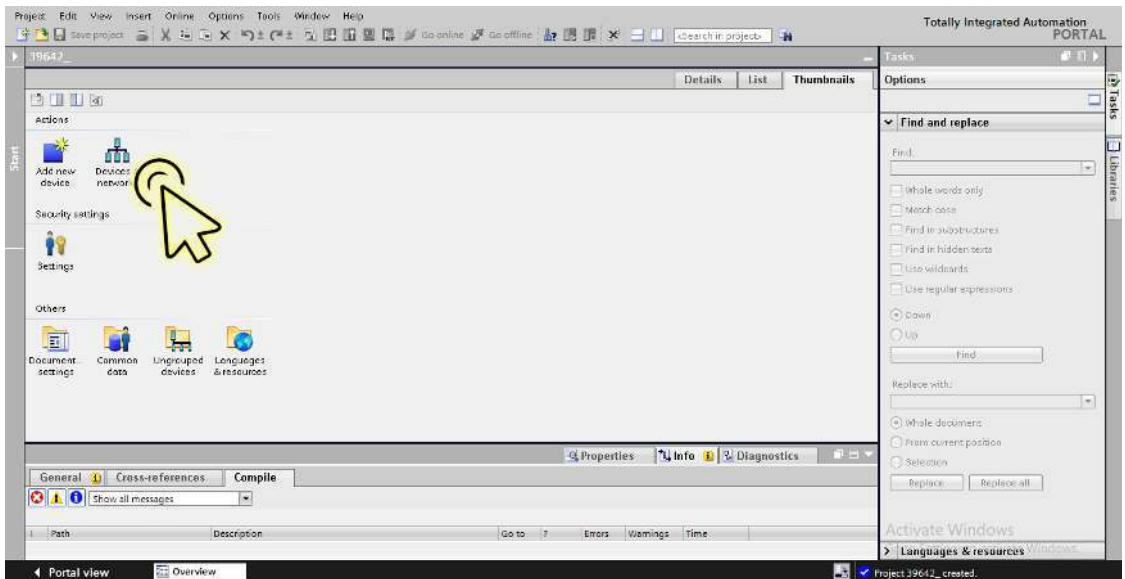

The dialog displays the *Devices & networks* window.

- In the *Network view* tab, click the icon of the device.

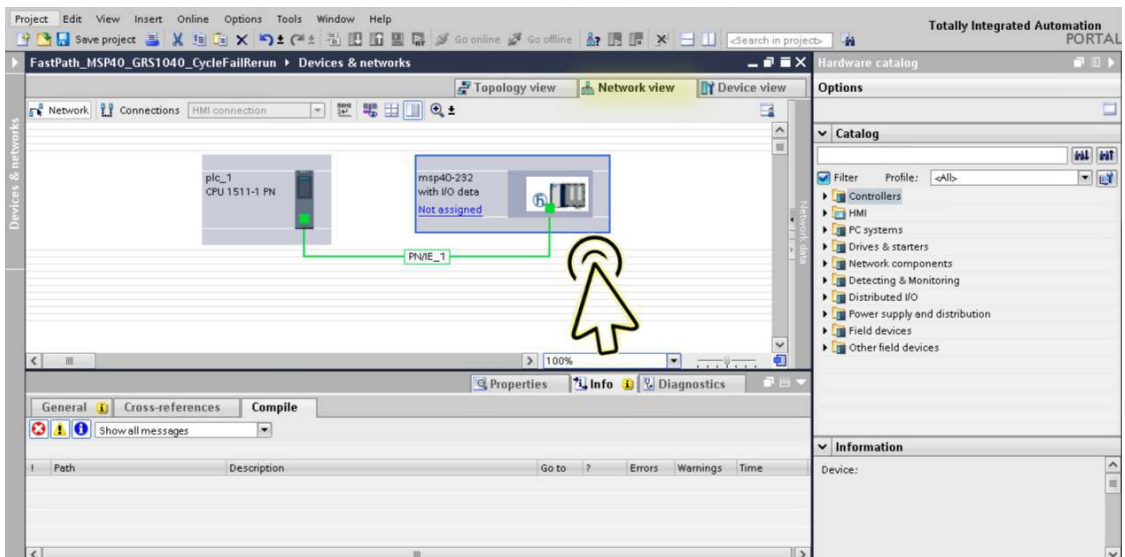

- Select the *Device view* tab to display the device details.

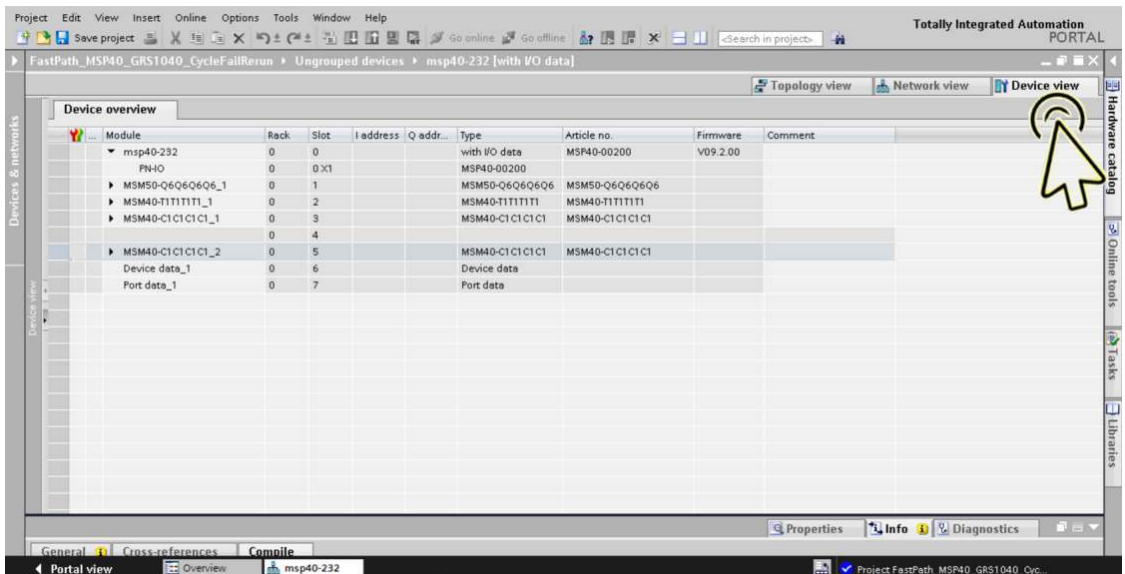

- Select the *Hardware catalog* tab in the right margin to display the available SFP submodules.

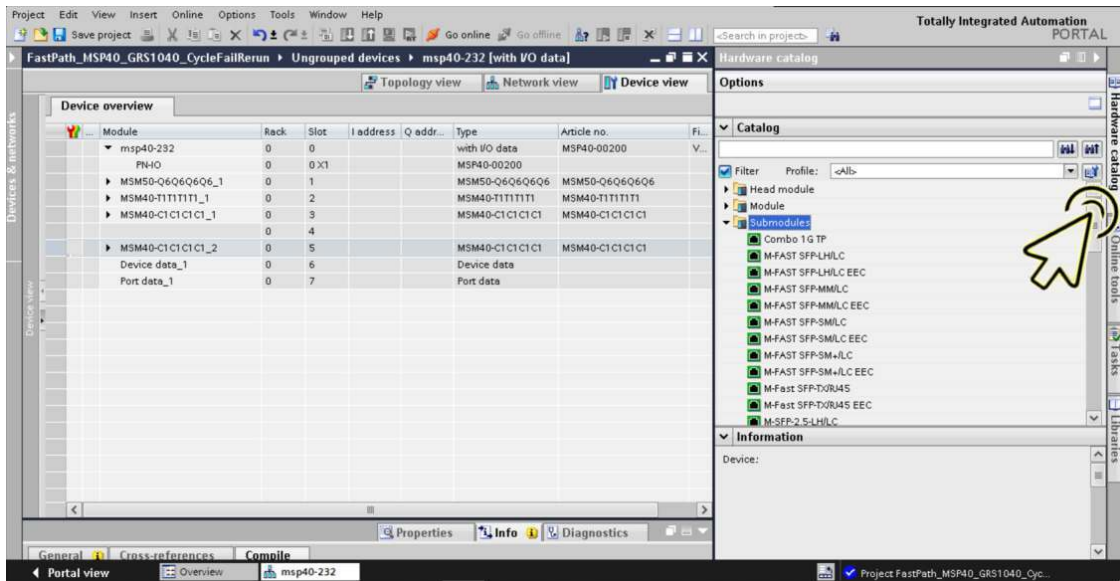

- Select the required SFP submodule.

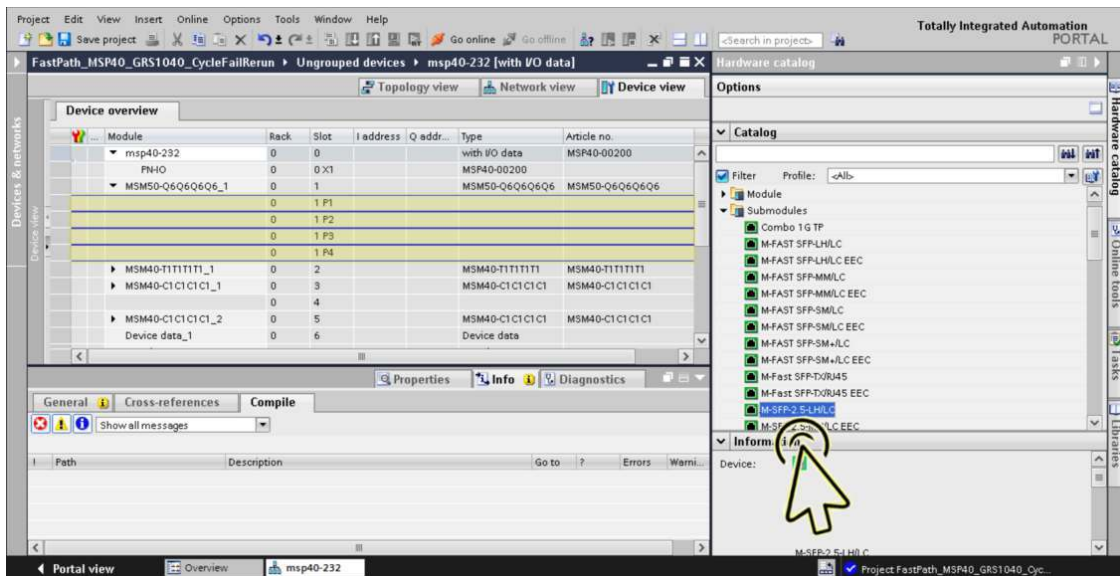

In the *Device view* tab, the slot which is logically connected to the device is highlighted.

- Drag the selected SFP submodule, and drop it onto the highlighted slot in the *Device view* tab.

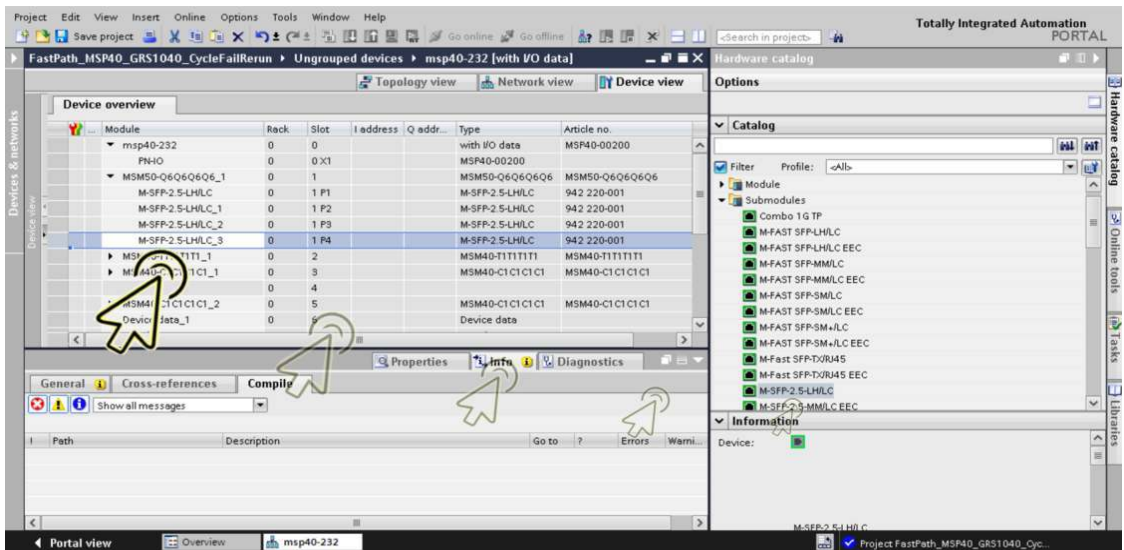

- Click the *Save project* icon.

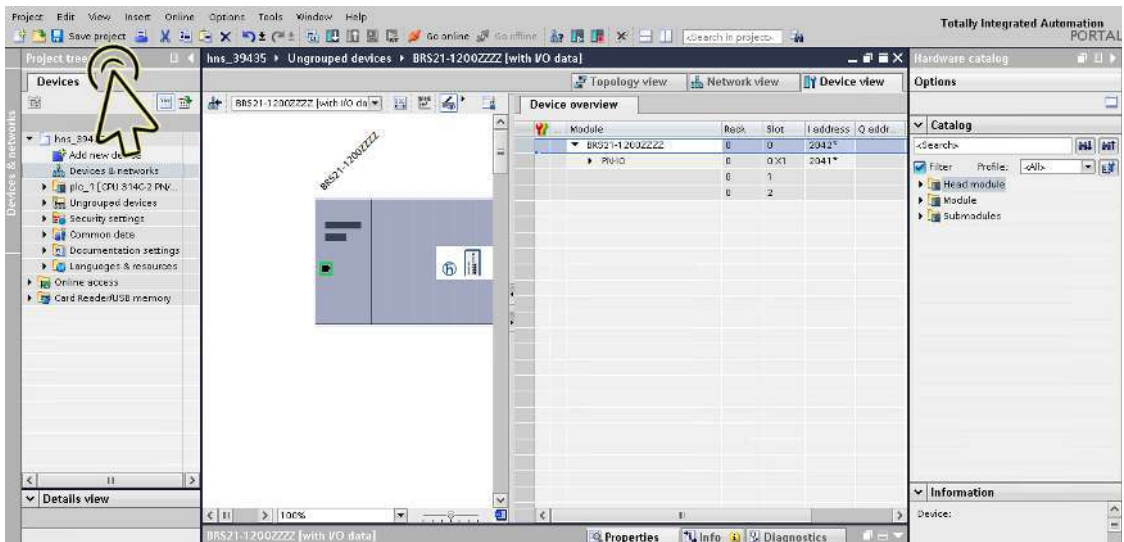

Note: Verify that the SFP submodule you added in the TIA Portal and the physically connected SFP submodule are of the same type. Otherwise, the Application Relation may not be set up correctly.

Configuring the port properties

In a modular device with n I/O modules, the I/O modules are represented by the slots 1 through n . The ports of a particular I/O module are represented by subslots in the respective slot. The *device data* module is represented by the next to last slot ($n+1$) and the *port data* module is represented by the last slot ($n+2$).

A non-modular device with n ports only has the slot 0. The ports are represented as subslots 1 through n in slot 0. The *device data* module is represented by the next to last subslot ($n+1$) and the *port data* module is represented by the last subslot ($n+2$).

Set up the port link monitoring alarm. To do this, perform the following steps:

- Click the *Project view* icon.

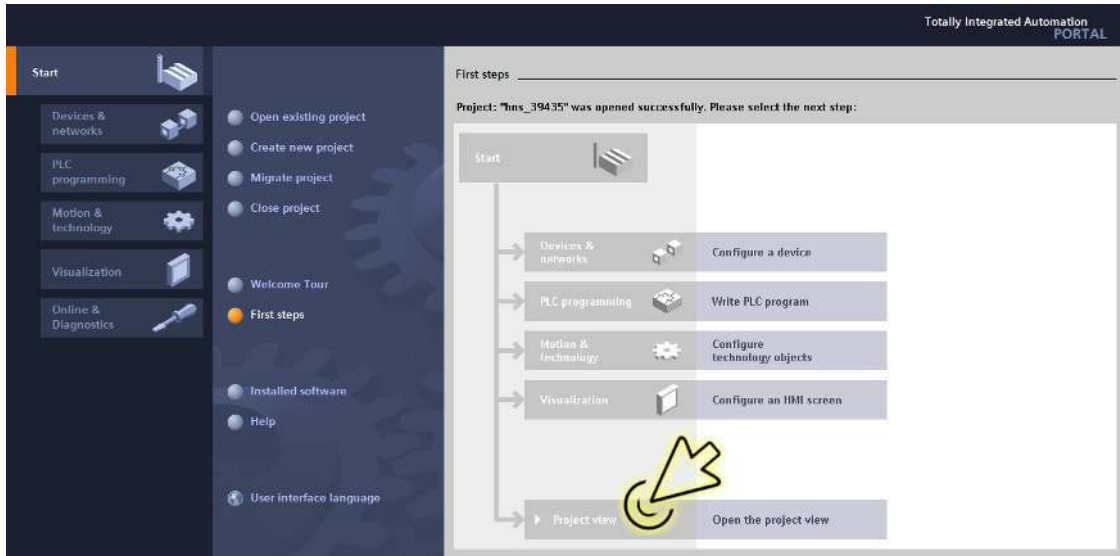

The dialog displays the *Project view* window.

- Click the *Overview* tab in the footer.

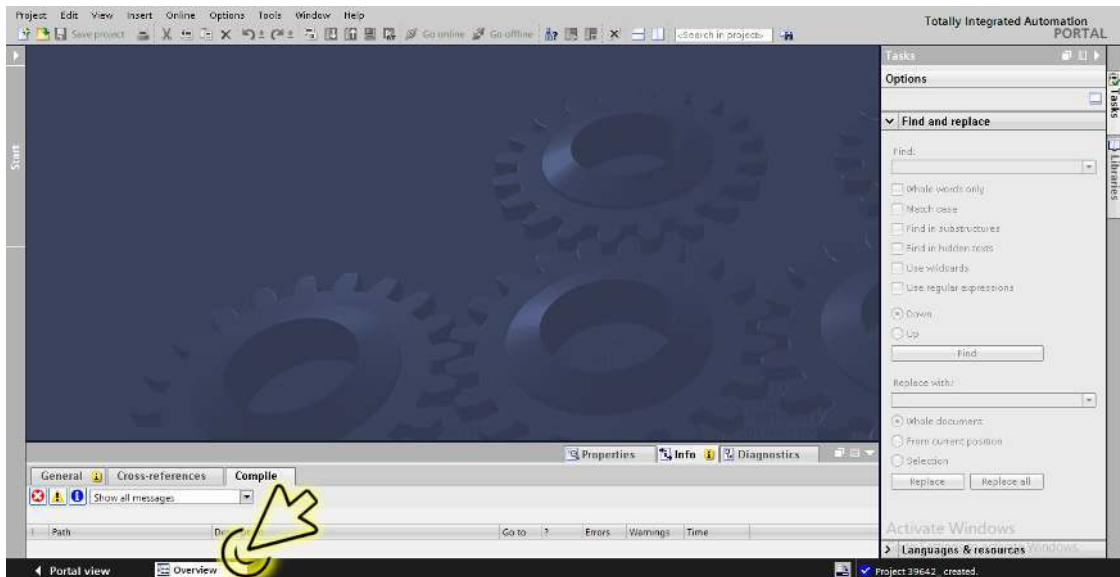

The dialog displays the *Overview* window.

- Double-click the *Devices & networks* icon.

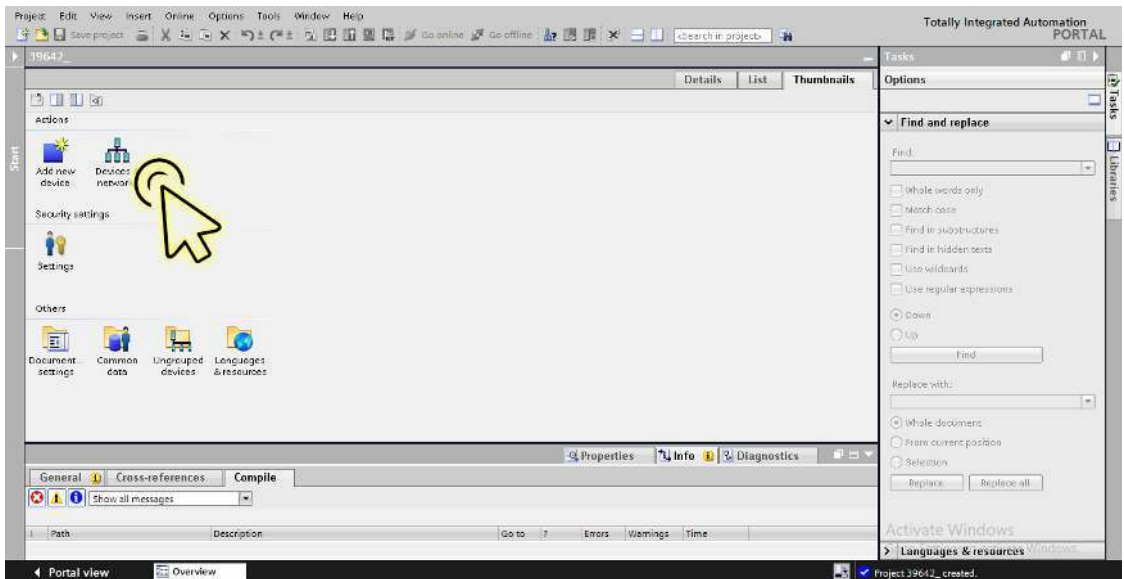

The dialog displays the *Devices & networks* window.

- In the *Network view* tab, click the icon of the device.

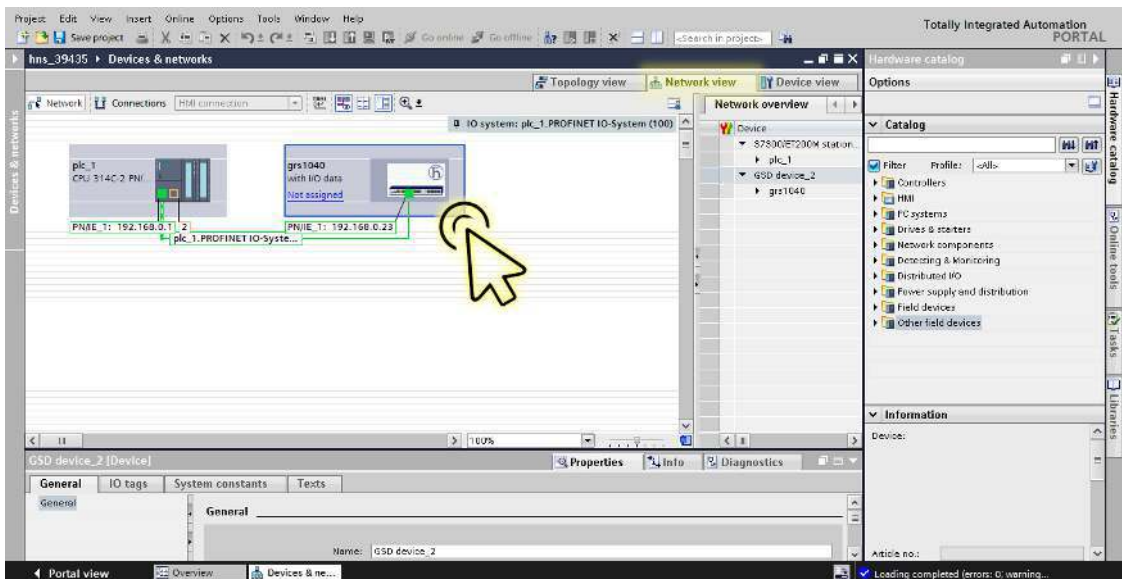

- Select the *Device view* tab to display the device details.

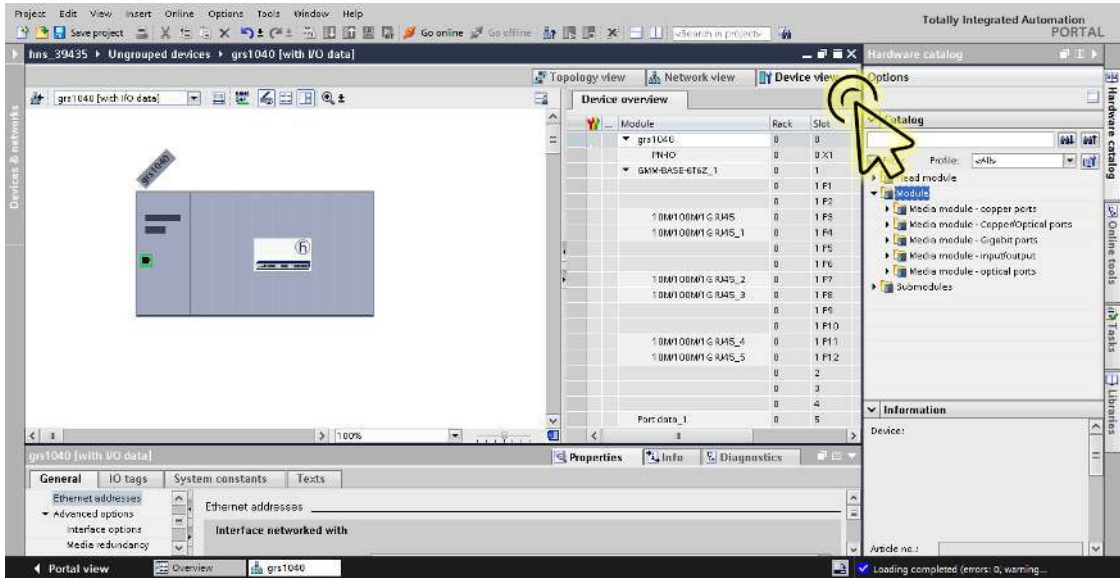

- Select the *Properties* tab. The *Properties* tab contains additional tabs.

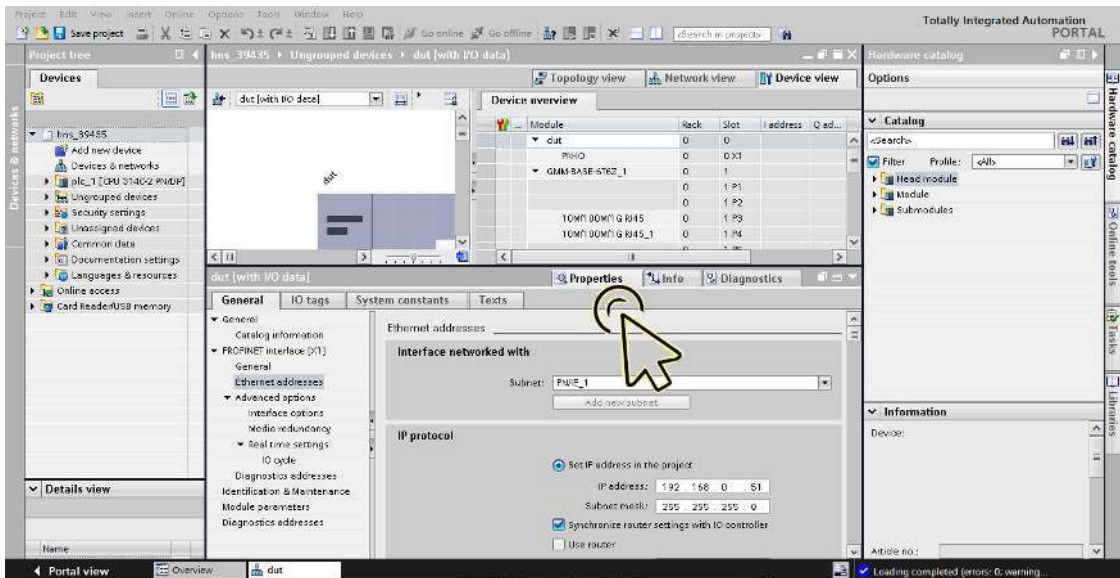

- In the *General* tab, navigate to the *PROFINET interface [X1] > Advanced options* item, then click the required port.

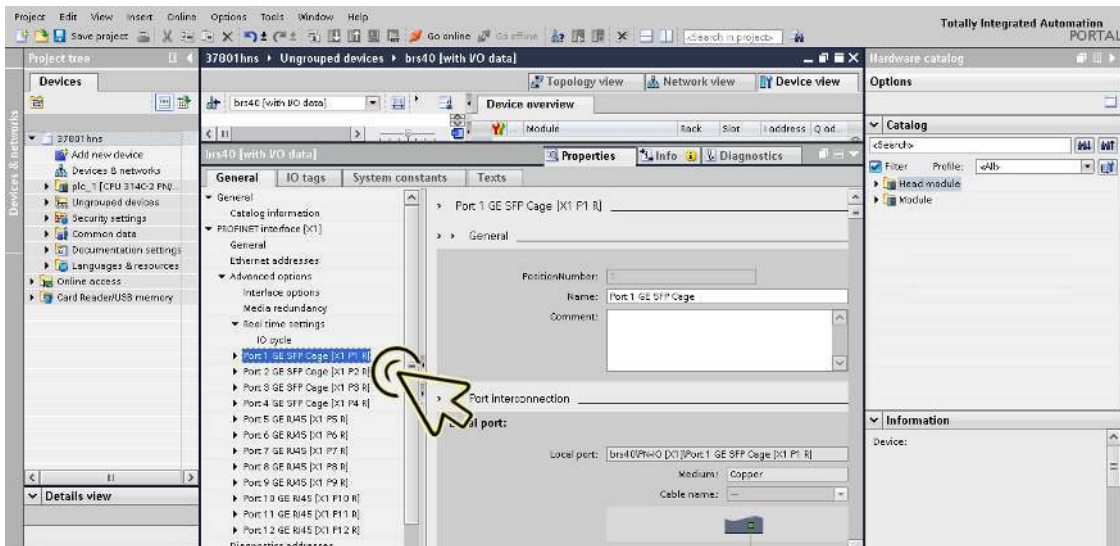

- In the *Port options* section, *Connection* frame, mark the *Monitor* checkbox.

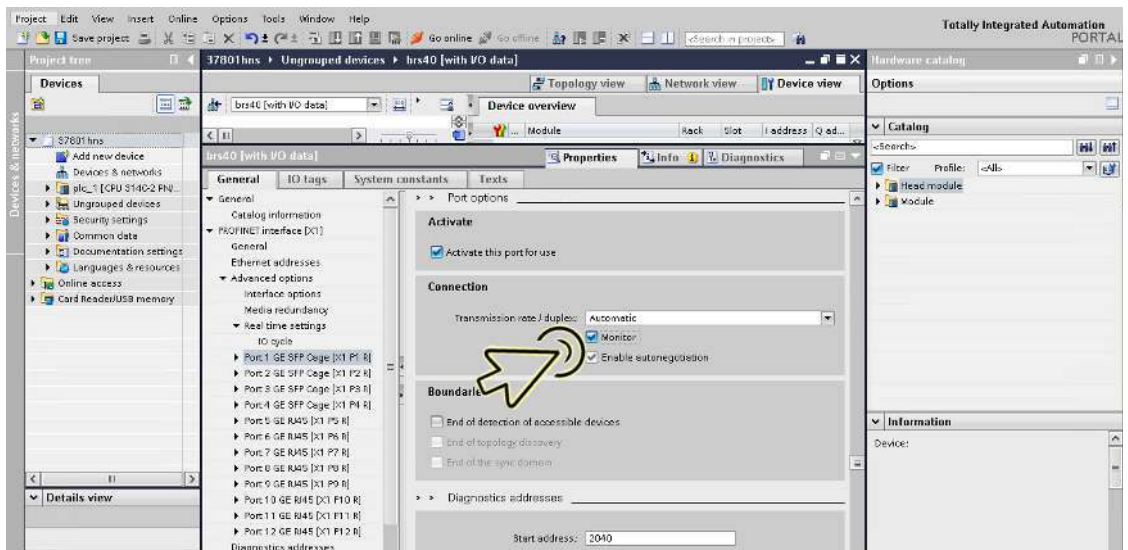

- Click the *Save project* button.

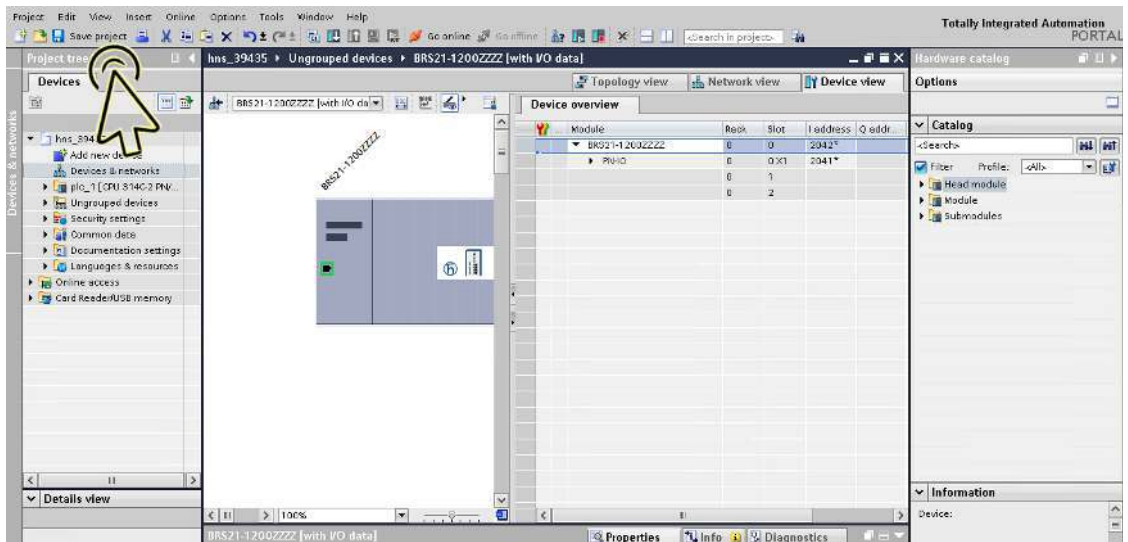

Note: To test the port link monitor device function, you can temporarily unplug the data cable from the respective port.

Configuring the connection options

Perform the following steps:

- Click the *Project view* icon.

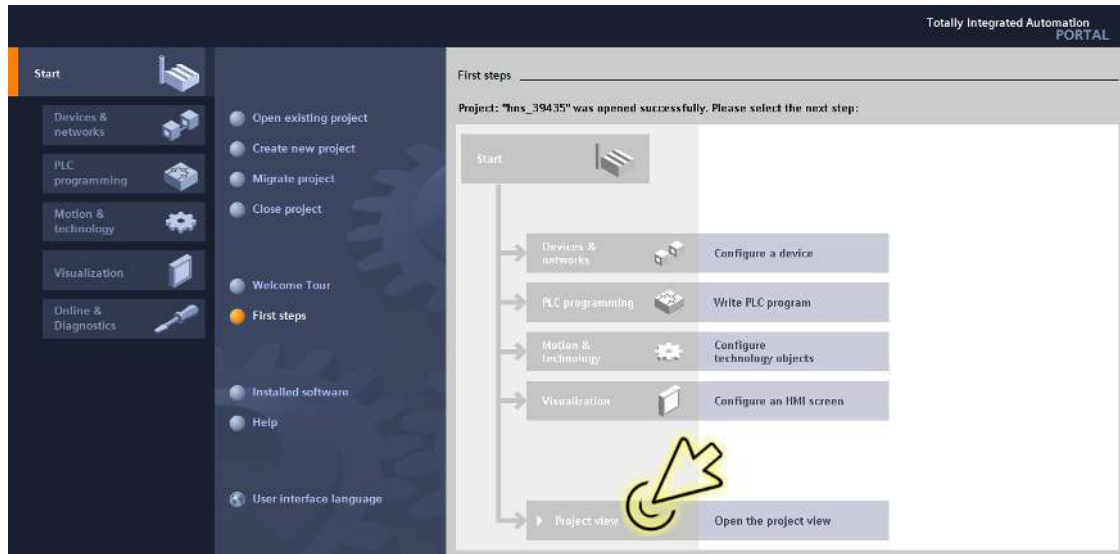

The dialog displays the *Project view* window.

- Click the *Overview* tab in the footer.

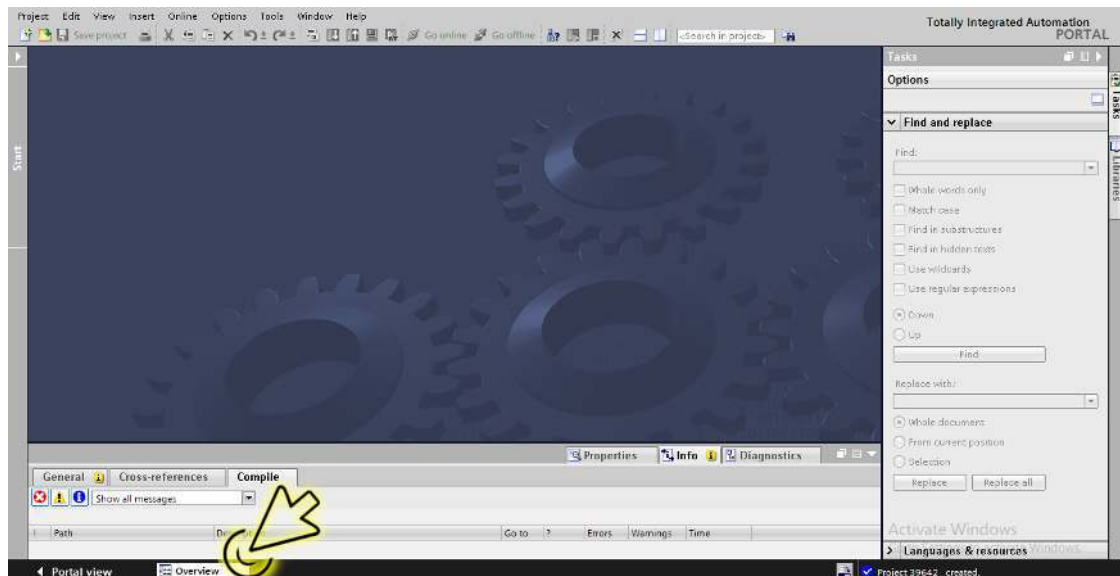

The dialog displays the *Overview* window.

- Double-click the *Devices & networks* icon.

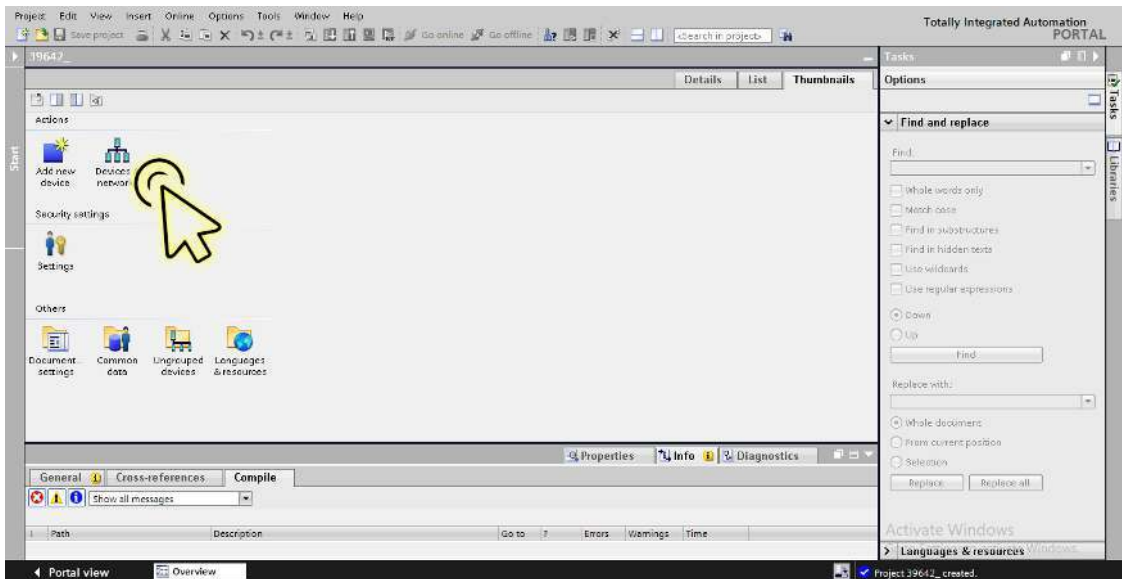

The dialog displays the *Devices & networks* window.

- In the *Network view* tab, click the icon of the device.

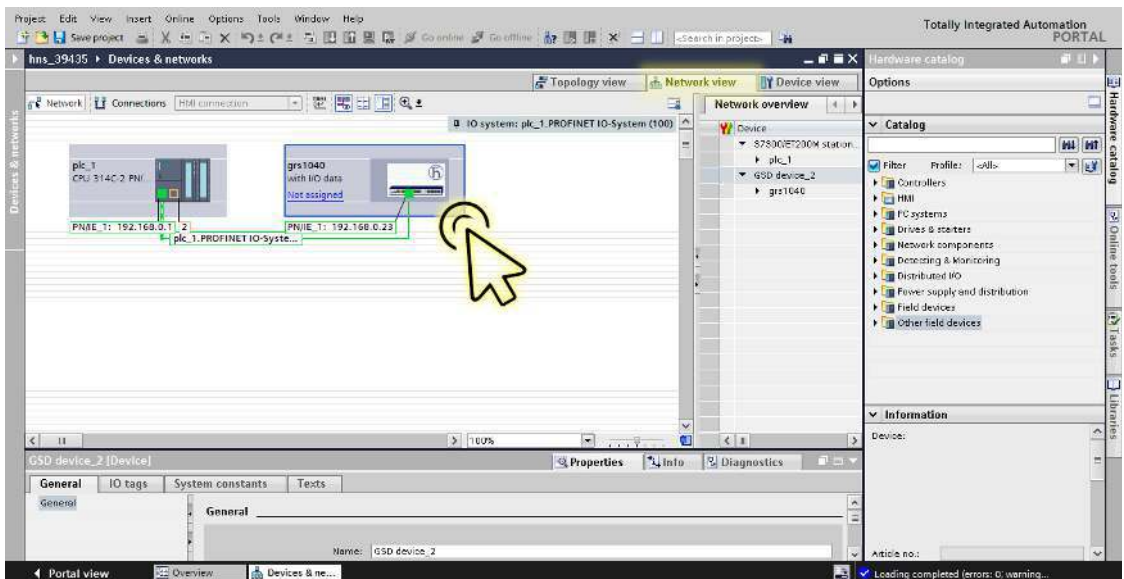

- Select the *Device view* tab to display the device details.

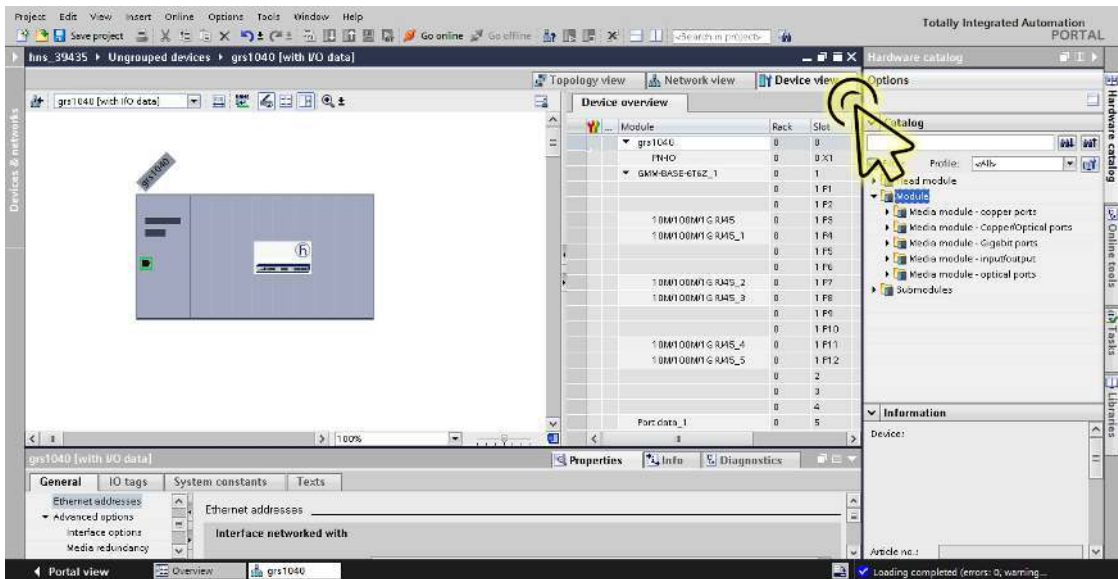

- Select the *Properties* tab.
The *Properties* tab contains additional tabs.

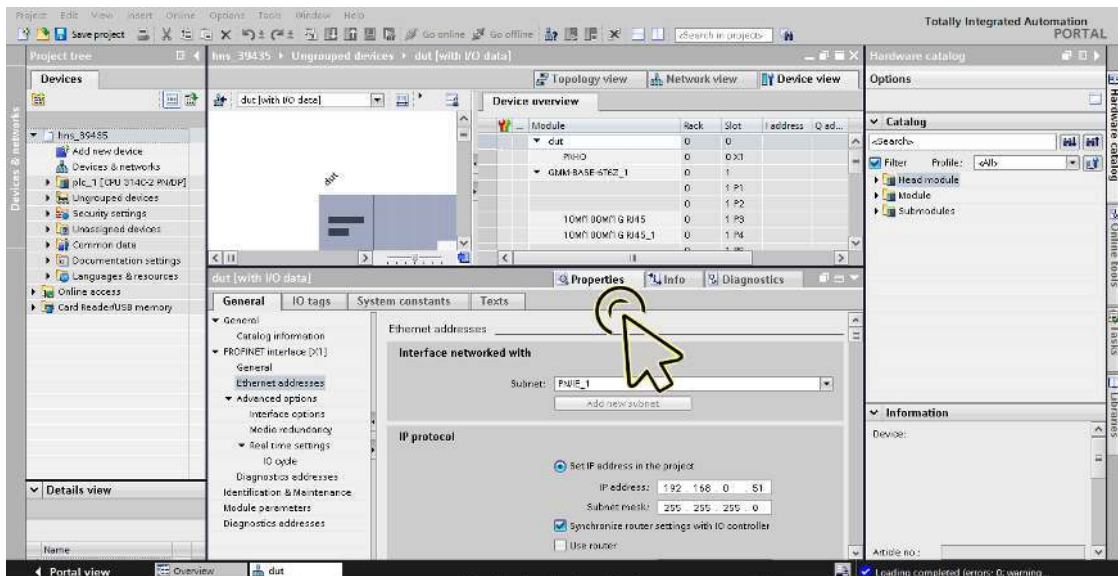

- In the *General* tab, navigate to the *PROFINET interface [X1] > Advanced options* item, then click the required port.

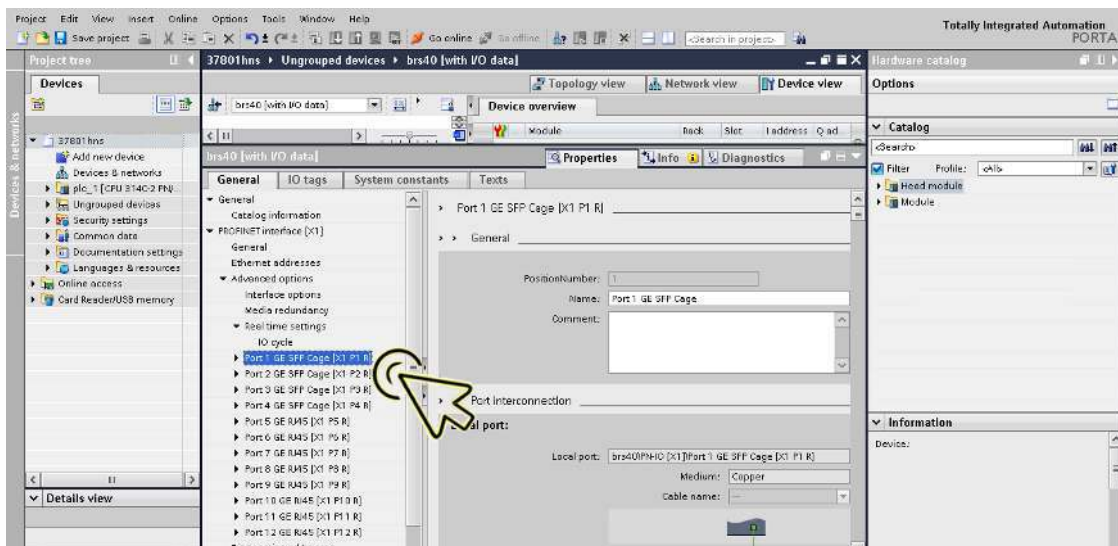

- In the *Port options* section, *Connection* frame, select the desired item from the *Transmission rate/duplex* drop-down list other than the *Automatic* item.

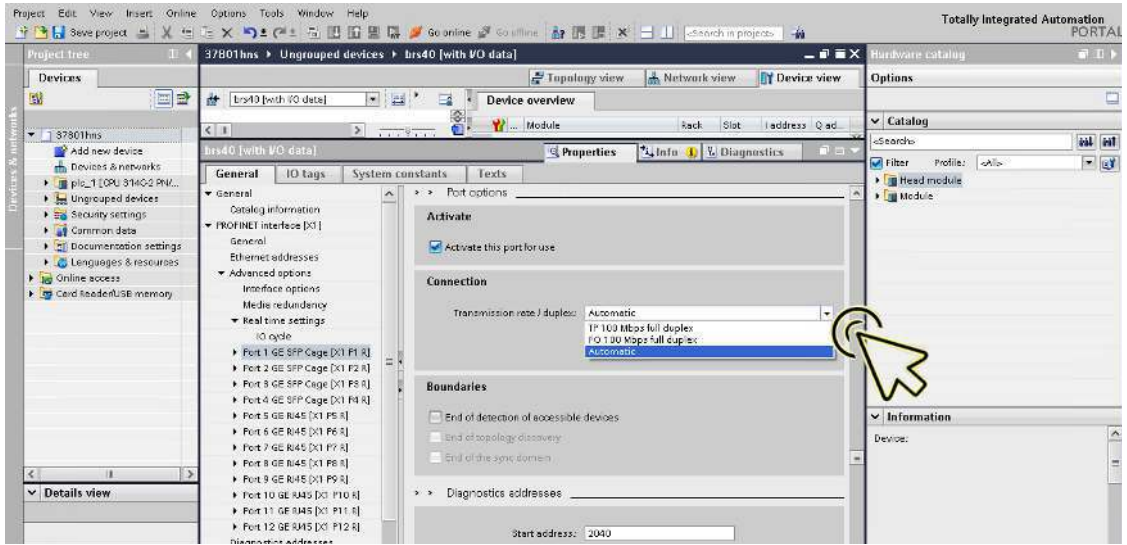

The device automatically marks the *Monitor* and *Enable autonegotiation* checkboxes.

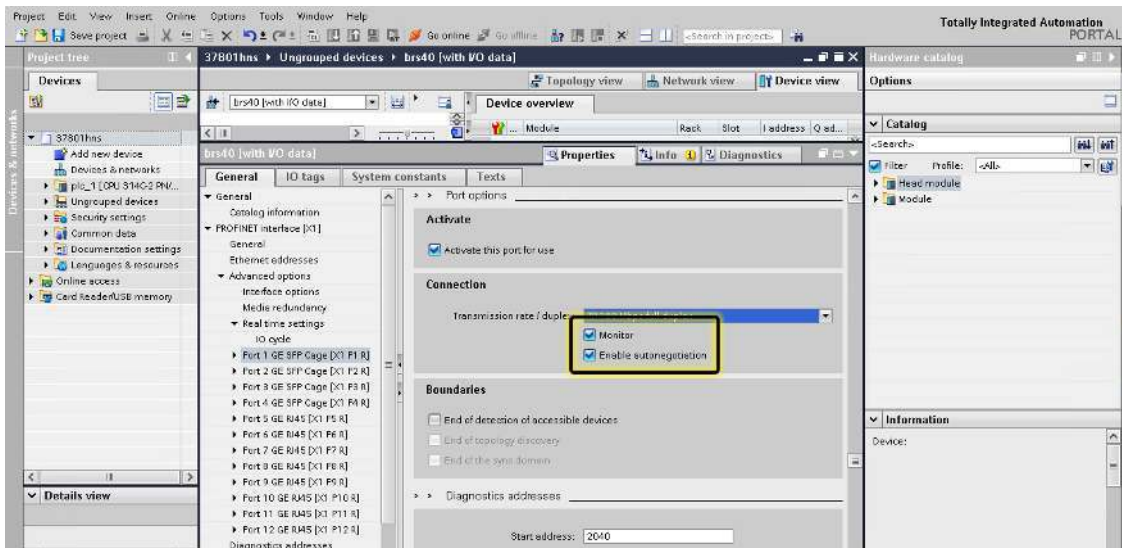

- Unmark the *Monitor* and *Enable autonegotiation* checkboxes.

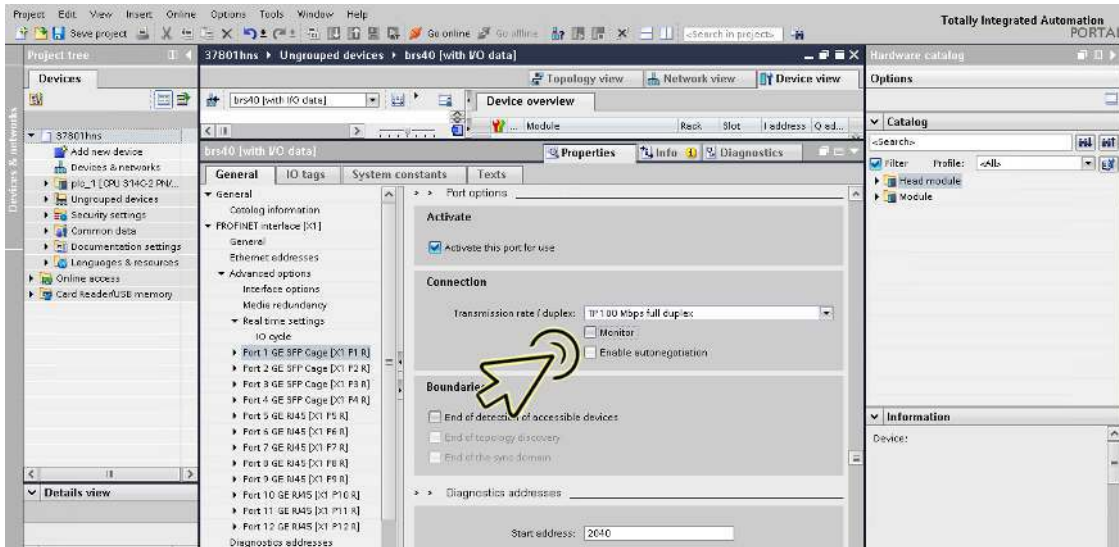

- Click the *Save project* button.

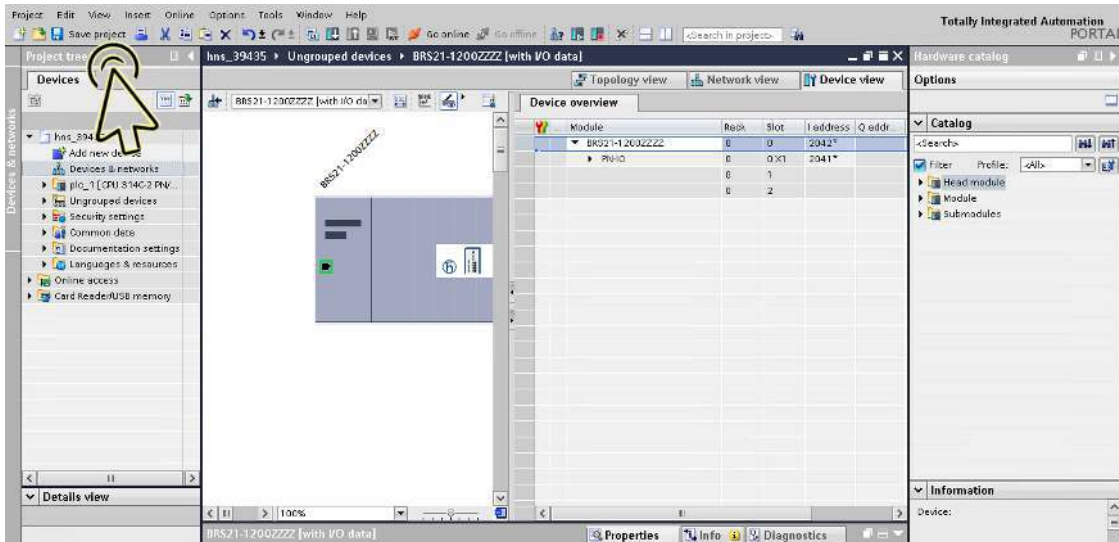

If you change the port setting to a value other than *Automatic settings*, then the device disables the port for a short time. If you have positioned the port on the path between the I/O controller and the I/O device, then this interruption can possibly lead to a failure in establishing the Application Relation. Make the following provisions before changing the port setting:

Note: Before disabling RSTP on certain ports, make sure that this will not result in loops.

Deactivate RSTP on the device ports between the I/O controller and the I/O device.

- Open the *Switching > L2-Redundancy > Spanning Tree > Port* dialog, *CIST* tab.
- Unmark the *STP active* checkbox for the relevant ports.
- Apply the settings temporarily. To do this, click the ✓ button.

Set up the topology monitoring alarm. To do this, perform the following steps:

- Click the *Project view* icon.



The dialog displays the *Project view* window.

- Click the *Overview* tab in the footer.

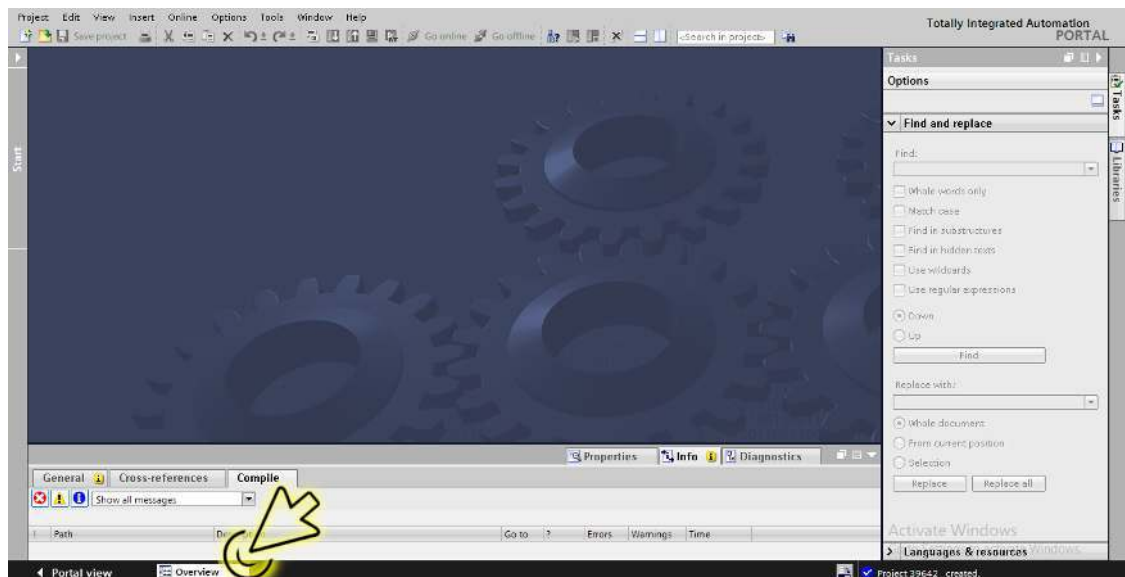

The dialog displays the *Overview* window.

- Double-click the *Devices & networks* icon.

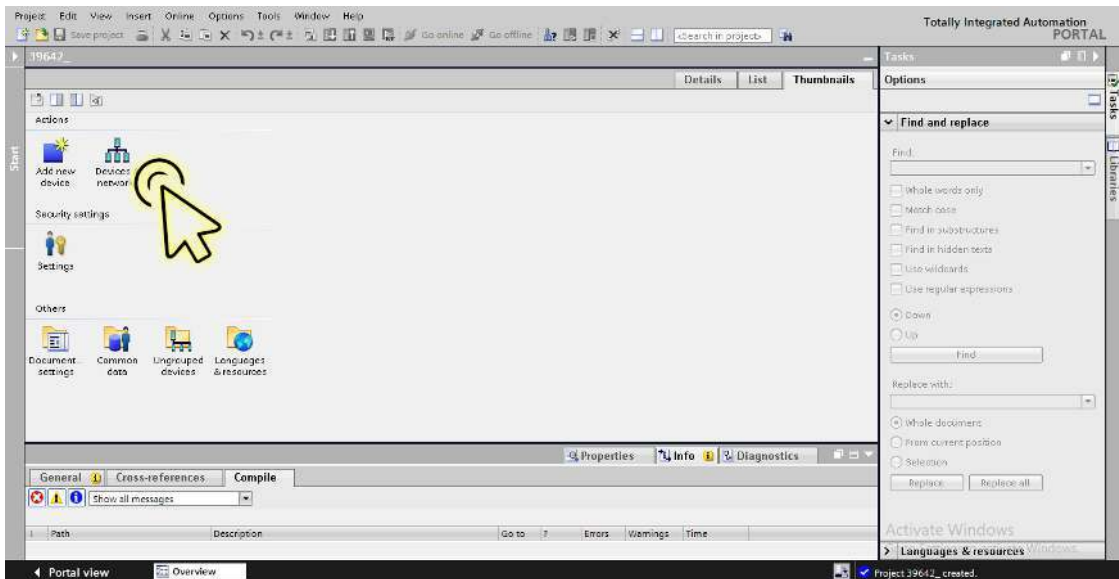

The dialog displays the *Devices & networks* window.

- In the *Network view* tab, click the icon of the device.

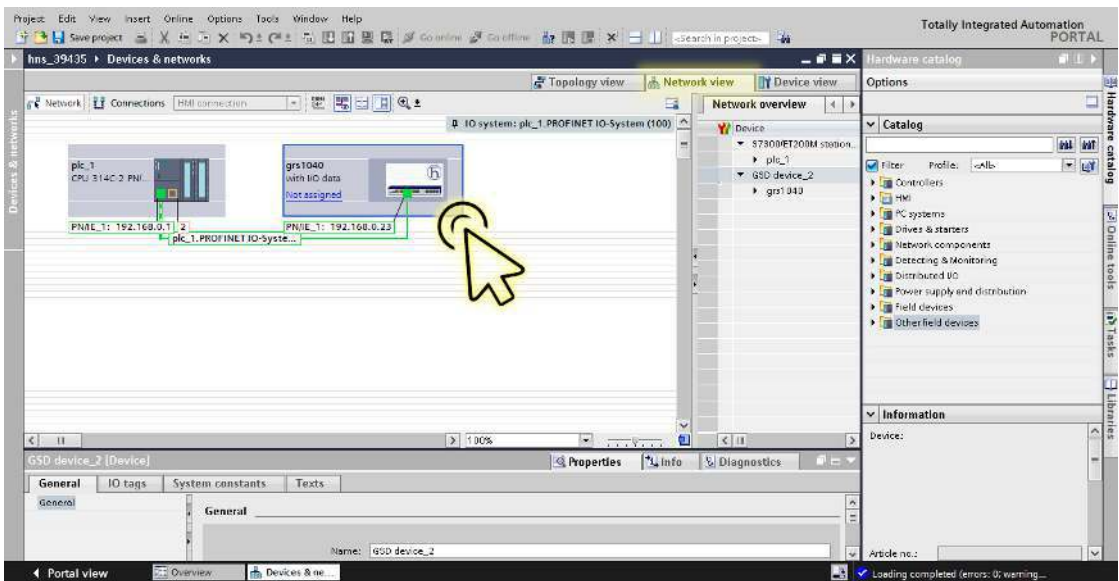

- Select the *Device view* tab to display the device details.

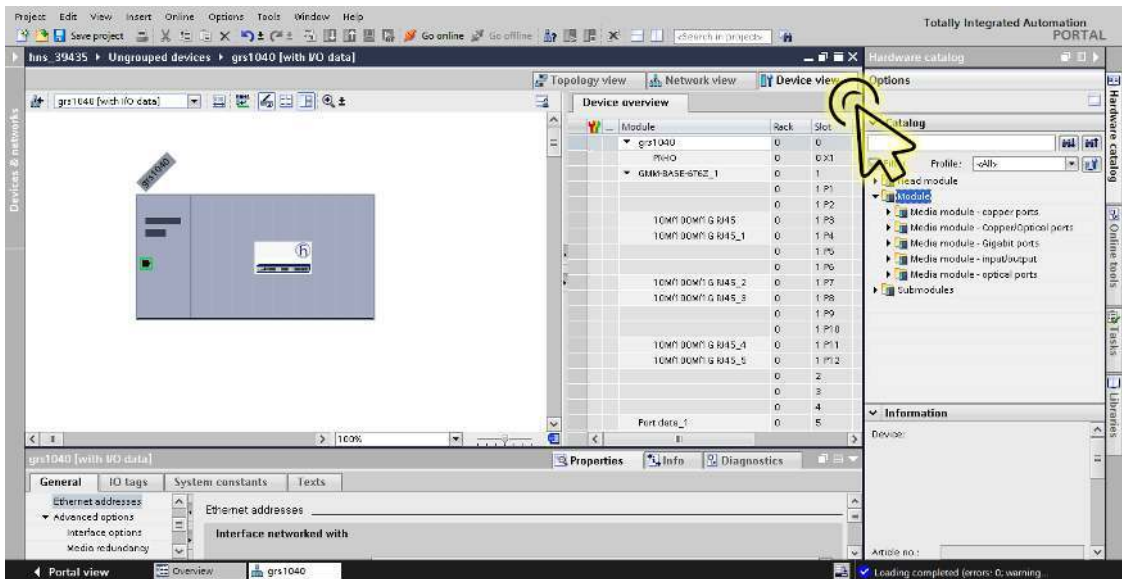

- Select the *Properties* tab. The *Properties* tab contains additional tabs.

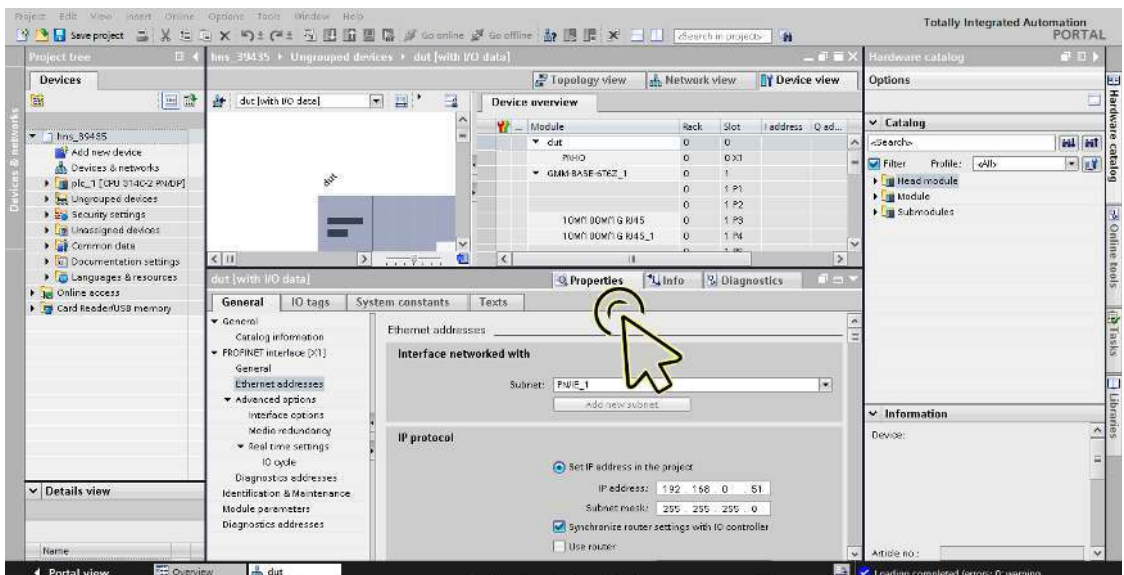

- In the *General* tab, navigate to the *PROFINET interface [X1] > Advanced options* item, then click the required port.

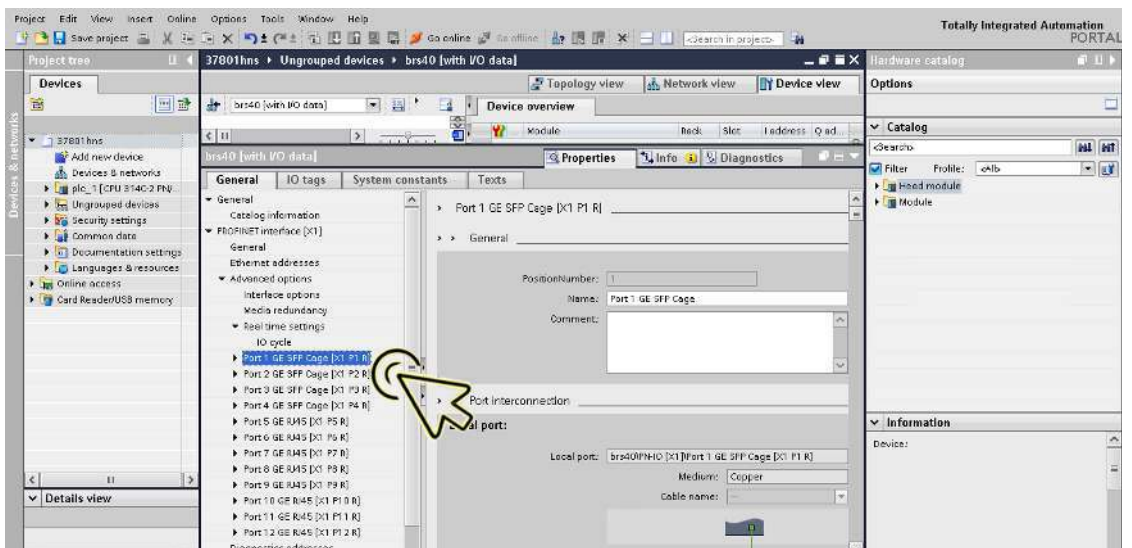

- In the *Port interconnection* section, *Partner port* frame, *Partner port* field, browse and select the port of the partner device with which the device is connected.

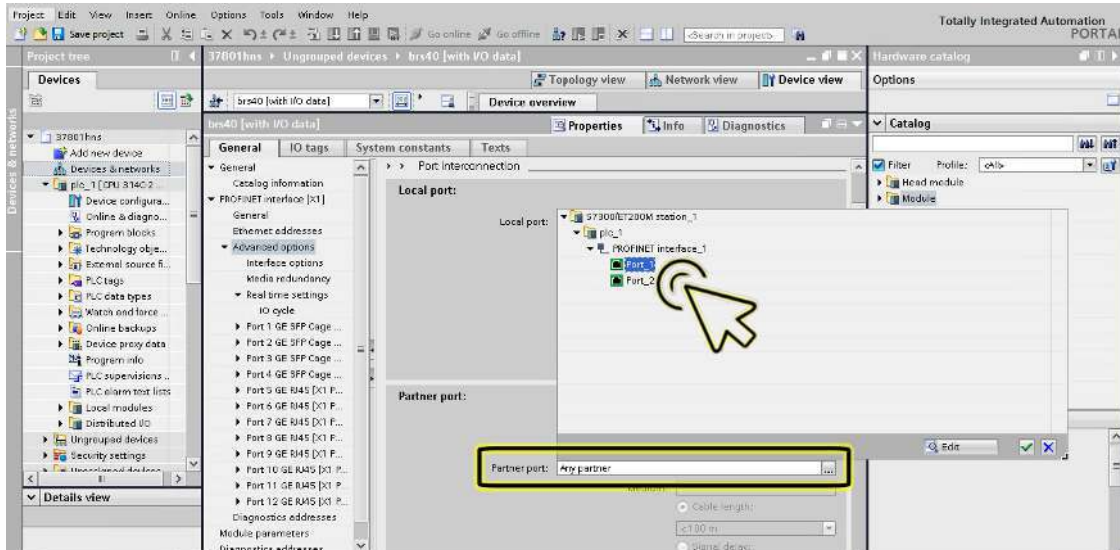

- To apply the changes, click the ✓ button.

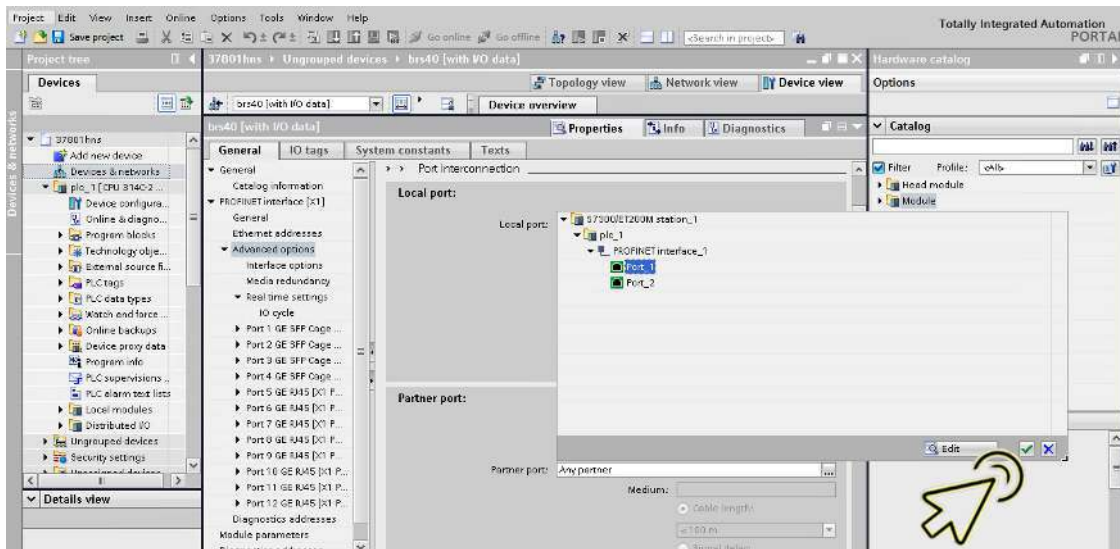

- Click the *Save project* button.

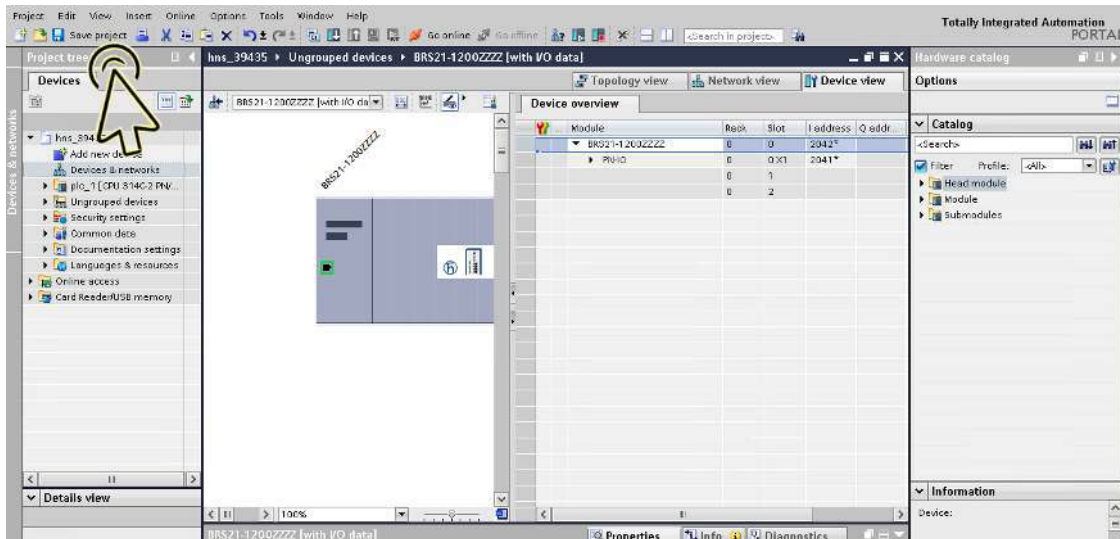

Note: *PROFINET* monitors the topology configuration. If you connect the port of the Hirschmann device to a different port of the partner device, then the Hirschmann device generates an alarm with the error message *Wrong partner port*.

The alarm ceases when you reconnect the port of the Hirschmann device to the set-up port of the partner device.

Swapping devices

Hirschmann devices support the device swapping function with an engineering station.

When identical devices are swapped, the engineering station assigns the parameters of the original device to the new device.

The device swapping function with the TIA Portal has the following prerequisites:

- ▶ S7 1511 with software release from v2.6, currently available for CPU 1511 or higher
- ▶ Hirschmann device software release from 08.8.00
- ▶ The neighboring devices support *LLDP*.
- ▶ The topology is set up and loaded onto the TIA Portal.

Prerequisites for the replacement device:

- ▶ The replacement device is exactly of the same type as the original device.
- ▶ The replacement device is connected to the exact same place in the network (same ports and neighboring devices).
- ▶ The replacement device has a *PROFINET* default configuration:
 - System name = "" (empty string)
 - IP address = 0.0.0.0
Netmask = 0.0.0.0
Gateway address = 0.0.0.0
 - or
 - *DHCP* is activated
 - *PROFINET* is activated

When these conditions are met, the engineering station automatically assigns the parameters of the original device (device name, IP parameters, and configuration data) to the replacement device.

Perform the following steps:

- Make a note of the port assignments on the original device. Remove the original device from the system.
The PLC now detects an error.
- Insert the replacement device in the same position in the network. When you reconnect the ports, verify that the port assignments are the same as for the original device.
The PLC finds the replacement device and sets it up the same way as the original device.
The PLC then detects proper operation.
- When necessary, reset the PLC to *Run*.

Topology discovery

After you initialize the Topology discovery, the engineering station looks for connected devices.

Configuring the topology

The TIA Portal gives you the option to set up the topology and monitor it accordingly. The TIA Portal displays the connection parameters (quality and settings) in a colored graphic.

Communication diagnosis

The TIA Portal monitors the communication quality and outputs messages relating to detected communication problems.

15.3.5 PROFINET parameters

Alarms

The device supports alarms on the device and port levels.

Table 63: Alarms supported

Alarms on device level	Change in device status
	Failure of redundant power supply
	Failure/removal of ACA
	Removal of modules
Alarms on port level	Change in link status

Record parameters

The device provides records for:

- ▶ Device parameters
- ▶ Device status
- ▶ Port status/parameters

Table 64: Device parameters

Byte	Content	Access	Value	Meaning
0	Send alarm if status changes	rw	0	Do not send an alarm
			1	Send an alarm if the status of device changes.
1	Power Alarm	rw	0	Do not send an alarm
			1	When a power supply fails, send an alarm.
2	ACA Alarm	rw	0	Do not send an alarm
			1	When the ACA is removed, send an alarm.
3	Module Alarm	rw	0	Do not send an alarm
			1	When the module connections are changed, send an alarm.

Table 65: Device status

Byte	Content	Access	Value	Meaning
0	Device status	ro	0	Unavailable
			1	OK
			2	Error
1	Power supply unit 1	ro	0	Unavailable
			1	OK
			2	Error
2	Power supply unit 2	ro	0	OK
			1	Unavailable
			2	Error
3	Power supply unit 3	ro	0	Unavailable
			1	OK
			2	Error
4	Power supply unit 4	ro	0	Unavailable
			1	OK
			2	Error
5	Power supply unit 5	ro	0	Unavailable
			1	OK
			2	Error
6	Power supply unit 6	ro	0	Unavailable
			1	OK
			2	Error
7	Power supply unit 7	ro	0	Unavailable
			1	OK
			2	Error
8	Power supply unit 8	ro	0	Unavailable
			1	OK
			2	Error
9	Signal contact 1	ro	0	Unavailable
			1	Closed
			2	Open
10	Signal contact 2	ro	0	Unavailable
			1	Closed
			2	Open
11	Temperature	ro	0	Unavailable
			1	OK
			2	Threshold value for temperature exceeded or not reached
12	Fan	ro	0	Unavailable
			1	OK
			2	Fan failure

Table 65: Device status

Byte	Content	Access	Value	Meaning
13	Module removal	ro	0	Unavailable
			1	OK
			2	A module has been removed.
14	ACA removed	ro	0	Unavailable
			1	OK
			2	The ACA has been removed.
15	Not used		0	
			1	
			2	
16	Not used		0	
			1	
			2	
17	Connection	ro	0	Unavailable
			1	OK
			2	Connection failure

Table 66: Port status/parameters

Byte	Content	Access	Value	Meaning
0	Report port error	rw	0	Do not send an alarm
			1	When one of the port alarm reasons represented by bytes 4 .. 10 occurs, send an alarm.
1	Report connection error	rw	0	Do not send an alarm
			1	Send alarm if the connection has failed.
2	Transmission rate too high	rw	0	Do not send an alarm
			1	When the threshold values for the transmission rate are exceeded, send an alarm.
3	Port on	rw	0	Unavailable
			1	Port enabled
			2	Port disabled
4	Link status	ro	0	Unavailable
			1	Connection exists
			2	Connection interrupted
5	Bit rate	ro	0	Unavailable
			1	Unknown
			2	10 Mbit/s
			3	100 Mbit/s
			4	1 Gbit/s
			5	10 Gbit/s

Table 66: Port status/parameters

Byte	Content	Access	Value	Meaning
6	Duplex	ro	0	Unavailable
			1	Half-duplex
			2	Full-duplex
7	Auto-negotiation	ro	0	Unavailable
			1	Disabled
			2	Enabled

I/O Data

You find the bit assignment for the I/O data in the following table.

Table 67: Device I/O data

Direction	Byte	Bit	Meaning
	Bit values:	0	OK or unavailable
		1	Reason for report exists
Input	0	General	
		0	Device status
		1	Signal contact 1
		2	Signal contact 2
		3	Temperature
		4	Fan
		5	Module removal
		6	ACA removed
Input	1	Power supply status	
		0	Power supply unit 1
		1	Power supply unit 2
		2	Power supply unit 3
		3	Power supply unit 4
		4	Power supply unit 5
		5	Power supply unit 6
		6	Power supply unit 7
		7	Power supply unit 8

Table 67: Device I/O data

Direction	Byte	Bit	Meaning
Input	2		Supply voltage status
		0	Not used
		1	Not used
		2	Connection error
		3	Not used
		4	Not used
		5	Not used
		6	Not used
7	Not used		
Output			Not defined

Table 68: Port I/O data (Input)

Direction	Byte	Bit	Meaning
	Bit values:	0	No connection
		1	Active connection
Input	0		Connection status for ports 1 to 8
		0	Port 1
		1	Port 2
		2	Port 3
		3	Port 4
		4	Port 5
		5	Port 6
		6	Port 7
7	Port 8		
Input	1		Connection status for ports 9 to 16
		0	Port 9
		1	Port 10
		2	Port 11
		3	Port 12
		4	Port 13
		5	Port 14
		6	Port 15
7	Port 16		
Input	n		Connection for port $(n \times 8) + 1$ to port $(n \times 8) + 8$
		0	Port $(n \times 8) + 1$
		1	Port $(n \times 8) + 2$
		2	Port $(n \times 8) + 3$
		3	Port $(n \times 8) + 4$
		4	Port $(n \times 8) + 5$
		5	Port $(n \times 8) + 6$
		6	Port $(n \times 8) + 7$
7	Port $(n \times 8) + 8$		

Table 69: Port I/O data (Output)

Direction	Byte	Bit	Meaning
	Bit values:	0	Port activated
		1	Port not activated
Output	0		Status "Port activated" for ports 1 to 8
		0	Port 1 activated
		1	Port 2 activated
		2	Port 3 activated
		3	Port 4 activated
		4	Port 5 activated
		5	Port 6 activated
		6	Port 7 activated
		7	Port 8 activated
Output	1		Status "Port activated" for ports 9 to 16
		0	Port 9 activated
		1	Port 10 activated
		2	Port 11 activated
		3	Port 12 activated
		4	Port 13 activated
		5	Port 14 activated
		6	Port 15 activated
		7	Port 16 activated
Output	n		Status "Port activated" for port $(n \times 8) + 1$ to port $(n \times 8) + 8$
		0	Port $(n \times 8) + 1$ activated
		1	Port $(n \times 8) + 2$ activated
		2	Port $(n \times 8) + 3$ activated
		3	Port $(n \times 8) + 4$ activated
		4	Port $(n \times 8) + 5$ activated
		5	Port $(n \times 8) + 6$ activated
		6	Port $(n \times 8) + 7$ activated
		7	Port $(n \times 8) + 8$ activated

A Setting up the configuration environment

A.1 Setting up a DHCP/BOOTP server

The following example describes the configuration of a DHCP server using the haneWIN DHCP Server software. This shareware software is a product of IT-Consulting Dr. Herbert Hanewinkel. You can download the software from www.hanewin.net. You can test the software for 30 calendar days from the date of the first installation, and then decide if you want to purchase a license.

Perform the following steps:

- Install the DHCP server on your PC.
To carry out the installation, follow the installation assistant.
- Start the *haneWIN DHCP Server* program.

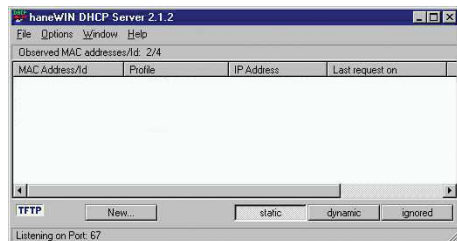

Figure 57: Start window of the *haneWIN DHCP Server* program

Note: When Windows is activated, the installation procedure includes a service that is automatically started in the basic configuration. This service is also active although the program itself has not been started. When started, the service responds to DHCP queries.

- In the menu bar, click the items *Options > Preferences* to open the program settings window.
- Select the *DHCP* tab.
- Specify the settings displayed in the figure.

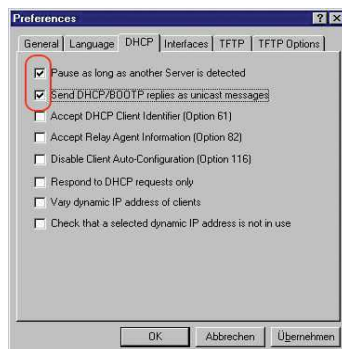

Figure 58: DHCP setting

- Click the *OK* button.
- To enter the configuration profiles, click in the menu bar the items *Options > Configuration Profiles*.

- Specify the name for the new configuration profile.

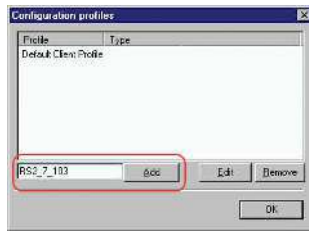

Figure 59: Adding configuration profiles

- Click the **Add** button.
- Specify the netmask.

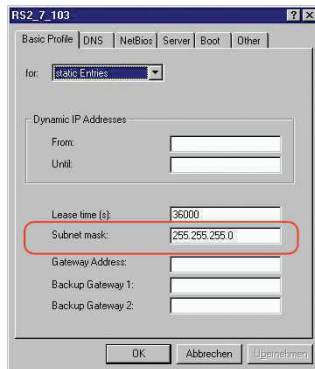

Figure 60: Netmask in the configuration profile

- Click the **Apply** button.
- Select the **Boot** tab.
- Enter the IP address of your tftp server.
- Enter the path and the file name for the configuration file.

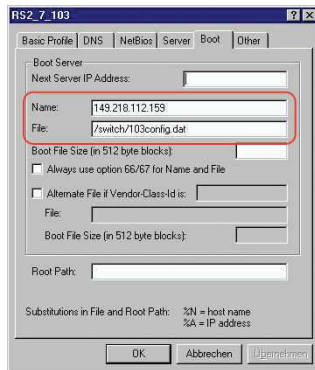

Figure 61: Configuration file on the tftp server

- Click the **Apply** button and then the **OK** button.
- Add a profile for each device type.
 When devices of the same type have different configurations, you add a profile for each configuration.

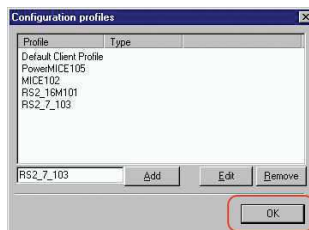

Figure 62: Managing configuration profiles

- To complete the addition of the configuration profiles, click the **OK** button.

- To enter the static addresses, in the main window, click the *Static* button.

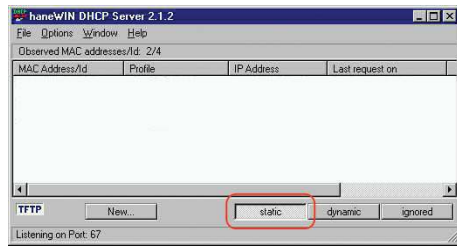

Figure 63:Static address input

- Click the *Add* button.

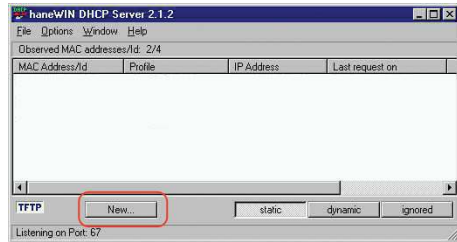

Figure 64:Adding static addresses

- Enter the MAC address of the device.
- Enter the IP address of the device.

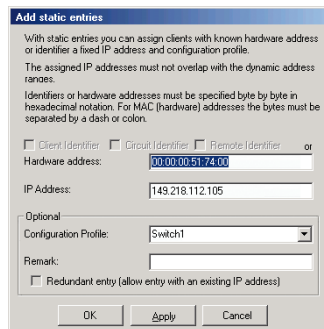

Figure 65:Entries for static addresses

- Select the configuration profile of the device.
- Click the *Apply* button and then the *OK* button.
- Add an entry for each device that will get its parameters from the DHCP server.

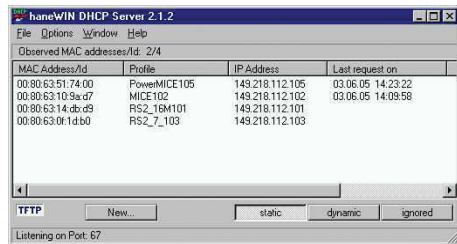

Figure 66:DHCP server with entries

A.2 Setting up a DHCP server with Option 82

The following example describes the configuration of a DHCP server using the haneWIN DHCP Server software. This shareware software is a product of IT-Consulting Dr. Herbert Hanewinkel. You can download the software from www.hanewin.net. You can test the software for 30 calendar days from the date of the first installation, and then decide if you want to purchase a license.

Perform the following steps:

- Install the DHCP server on your PC.
To carry out the installation, follow the installation assistant.
- Start the *haneWIN DHCP Server* program.

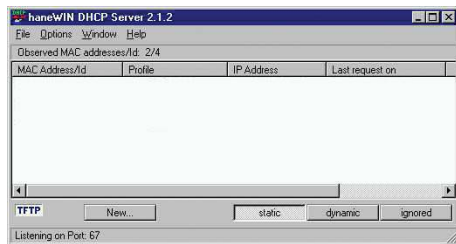

Figure 67: Start window of the *haneWIN DHCP Server* program

Note: When Windows is activated, the installation procedure includes a service that is automatically started in the basic configuration. This service is also active although the program itself has not been started. When started, the service responds to DHCP queries.

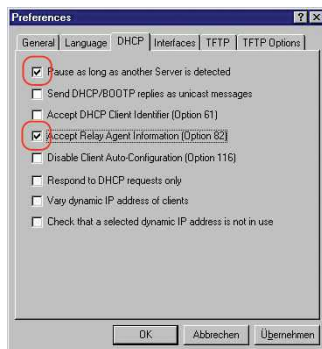

Figure 68: DHCP setting

- To enter the static addresses, click the *Add* button.

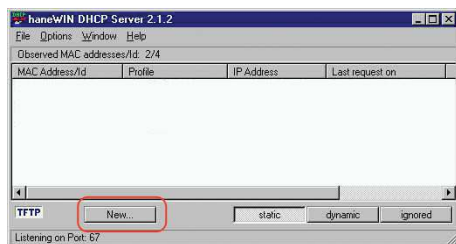

Figure 69: Adding static addresses

- Mark the *Circuit Identifier* checkbox.
- Mark the *Remote Identifier* checkbox.

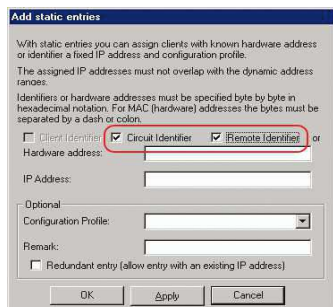

Figure 70: Default setting for the fixed address assignment

- In the *Hardware address* field, specify the value *Circuit Identifier* and the value *Remote Identifier* for the switch and port.

The DHCP server assigns the IP address specified in the *IP address* field to the device that you connect to the port specified in the *Hardware address* field.

The hardware address is in the following form:

`ciclhvvvvvssmmpprir1xxxxxxxxxxx`

- ▶ `ci`
Sub-identifier for the type of the Circuit ID
- ▶ `cl`
Length of the Circuit ID.
- ▶ `hh`
Hirschmann identifier:
`01` when a Hirschmann device is connected to the port, otherwise `00`.
- ▶ `vvvv`
VLAN ID of the DHCP request.
Default setting: `0001` = VLAN 1
- ▶ `ss`
Socket of device at which the module with that port is located to which the device is connected. Specify the value `00`.
- ▶ `mm`
Module with the port to which the device is connected.
- ▶ `pp`
Port to which the device is connected.
- ▶ `ri`
Sub-identifier for the type of the Remote ID
- ▶ `r1`
Length of the Remote ID.
- ▶ `xxxxxxxxxxx`
Remote ID of the device (for example MAC address) to which a device is connected.



Figure 71: Specifying the addresses

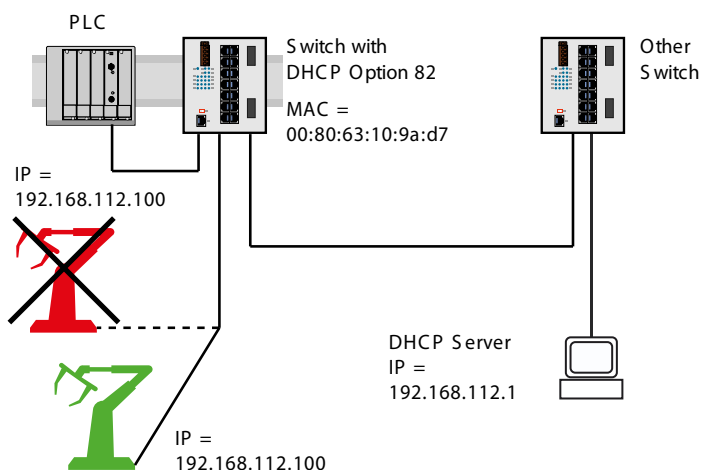

Figure 72: Application example of using Option 82

A.3 Preparing access using SSH



You can connect to the device using SSH. To do this, perform the following steps:

- ▶ Generate a key in the device.
- or
- ▶ Transfer your own key onto the device.
- ▶ Prepare access to the device in the SSH client program.

Note: In the default setting, the key is already existing and access using SSH is enabled.

A.3.1 Generating a key in the device

The device lets you generate the key directly in the device. To do this, perform the following steps:

- Open the *Device Security > Management Access > Server* dialog, *SSH* tab.
- To disable the SSH server, select the *Off* radio button in the *Operation* frame.
- Apply the settings temporarily. To do this, click the  button.
- To generate a RSA key, in the *Signature* frame, click the *Create* button.
- To enable the SSH server, select the *On* radio button in the *Operation* frame.
- Apply the settings temporarily. To do this, click the  button.

enable

To change to the Privileged EXEC mode.

configure

To change to the Configuration mode.

ssh key rsa generate



To generate a new RSA key.

A.3.2 Transferring your own key onto the device

OpenSSH gives experienced network administrators the option of generating their own key. To generate the key, enter the following commands on your PC:

```
ssh-keygen -q -t rsa -f rsa.key -C '' -N ''
rsaparam -out rsaparam.pem 2048
```

The device lets you transfer your own SSH key onto the device. To do this, perform the following steps:

- Open the *Device Security > Management Access > Server* dialog, *SSH* tab.
- To disable the SSH server, select the *Off* radio button in the *Operation* frame.
- Apply the settings temporarily. To do this, click the  button.
- When the file is located on your PC or on a network drive, drag and drop it onto the  area. As an alternative, click in the area to select the file.

- To transfer the file to the device, click the *Start* button.
- To enable the SSH server, select the *On* radio button in the *Operation* frame.
- Apply the settings temporarily. To do this, click the button.

Perform the following steps:

- Copy the self-generated key from your PC to the external memory.
- Copy the key from the external memory into the device.

enable

```
copy sshkey envm <file name>
```

To change to the Privileged EXEC mode.

To transfer your own key onto the device from the external memory.

A.3.3 Preparing the SSH client program

The *PuTTY* program lets you access the device using SSH. You can download the software from www.chiark.greenend.org.uk/~sgtatham/putty/.

Perform the following steps:

- Start the program by double-clicking on it.

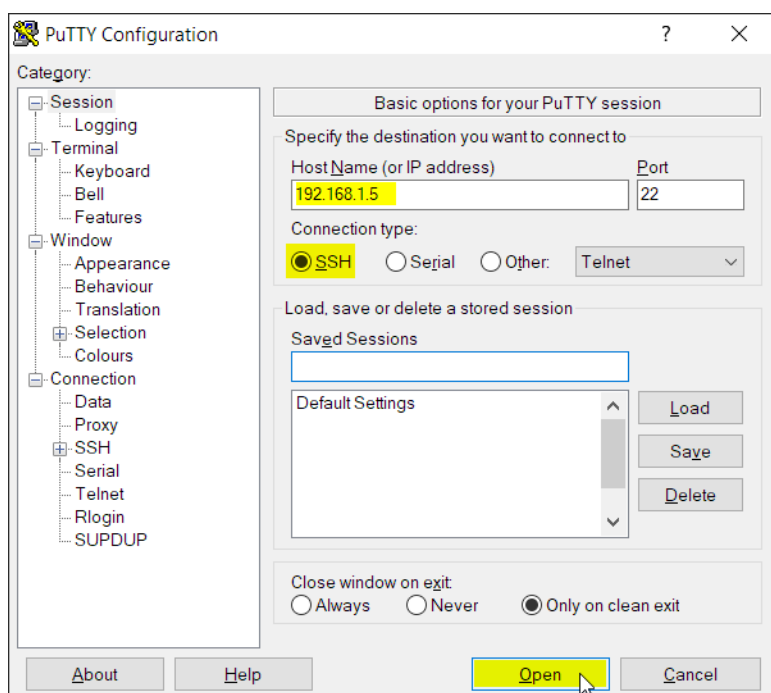

Figure 73: PuTTY input screen

- In the *Host Name (or IP address)* field you enter the IP address of your device. The IP address (a.b.c.d) consists of 4 decimal numbers with values from 0 to 255. The 4 decimal numbers are separated by points.
- To select the connection type, select the *SSH* radio button in the *Connection type* option list.
- Click the *Open* button to set up the data connection to your device.

Before the connection is established, the *PuTTY* program displays a security alarm message and lets you check the key fingerprint.

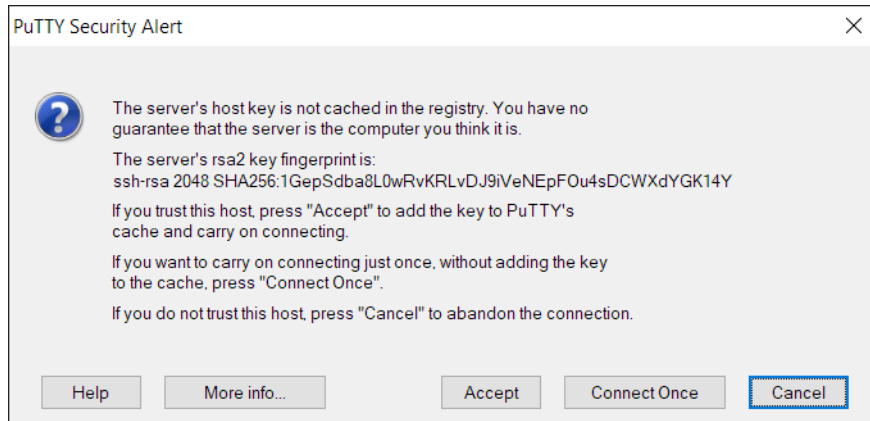

Figure 74: Security alert prompt for the fingerprint

Before the connection is established, the *PuTTY* program displays a security alarm message and lets you check the key fingerprint.

- Check the fingerprint of the key to help ensure that you have actually connected to the desired device.
- When the fingerprint matches your key, click the *Yes* button.

For experienced network administrators, another way of accessing your device through an SSH is by using the OpenSSH Suite. To set up the data connection, enter the following command:

```
ssh admin@10.0.112.53
```

admin is the user name.

10.0.112.53 is the IP address of your device.

A.4 HTTPS certificate

Your web browser establishes the connection to the device using the Hypertext Transfer Protocol Secure (HTTPS). The prerequisite is that you enable the *HTTPS server* function in the *Device Security > Management Access > Server* dialog, *HTTPS* tab.

Note: Third-party software applications such as web browsers validate digital certificates based on criteria such as their expiration date and current cryptographic parameter recommendations. Outdated digital certificates may cause issues due to invalid or outdated information. Example: A digital certificate has expired or the cryptographic recommendations have changed. To solve validation conflicts with third-party software applications, transfer your own up-to-date digital certificate onto the device or regenerate a self-signed digital certificate with the latest device software.

A.4.1 HTTPS certificate management



To establish a secure connection, a digital certificate in X.509 format is required. In the default setting, the device uses a self-signed digital certificate.

You can regenerate the self-signed digital certificate. To do this, perform the following steps:

- Open the *Device Security > Management Access > Server* dialog, *HTTPS* tab.
- To generate a self-signed digital certificate, in the *Certificate* frame, click the *Create* button.
- Apply the settings temporarily. To do this, click the  button.
- For the changes to take effect after transferring a digital certificate onto the device, disable and re-enable the HTTPS server. Restart the HTTPS server using the Command Line Interface.

enable	To change to the Privileged EXEC mode.
configure	To change to the Configuration mode.
https certificate generate	To generate a digital certificate for the HTTPS server.
no https server	To disable the <i>HTTPS</i> function.
https server	To enable the <i>HTTPS</i> function.

- The device also lets you transfer an externally generated digital certificate onto the device:

- Open the *Device Security > Management Access > Server* dialog, *HTTPS* tab.
- When the file is located on your PC or on a network drive, drag and drop it onto the  area. As an alternative, click in the area to select the file.
- To transfer the file to the device, click the *Start* button.
- Apply the settings temporarily. To do this, click the  button.

enable	To change to the Privileged EXEC mode.
copy httpscert envm <file name>	To transfer the digital certificate for the HTTPS server from the external memory onto the device.
configure	To change to the Configuration mode.
no https server	To disable the <i>HTTPS</i> function.
https server	To enable the <i>HTTPS</i> function.

Note: To activate the digital certificate after the device generated or you transferred it, reboot the device or restart the HTTPS server. Restart the HTTPS server using the Command Line Interface.

A.4.2 Access through HTTPS

The default setting for HTTPS data connection is TCP port 443. If you change the number of the HTTPS port, then reboot the device or the HTTPS server. Thus the change becomes effective. To do this, perform the following steps:

- Open the *Device Security > Management Access > Server* dialog, *HTTPS* tab.
- To enable the function, select the *On* radio button in the *Operation* frame.
- To access the device by HTTPS, enter HTTPS instead of HTTP in your web browser, followed by the IP address of the device.

enable	To change to the Privileged EXEC mode.
configure	To change to the Configuration mode.
https port 443	To specify the number of the TCP port on which the web server receives HTTPS requests from clients.
https server	To enable the <i>HTTPS</i> function.
show https	To display the status of the <i>HTTPS</i> server and the port number.

When you make changes to the HTTPS port number, disable the HTTPS server and enable it again to make the changes effective.

The device uses Hypertext Transfer Protocol Secure (HTTPS) and establishes a new data connection. When you log out at the end of the session, the device terminates the data connection.

B Appendix

B.1 Literature references

A small selection of books on network topics, ordered by publication date (newest first):

- ▶ *TSN – Time-Sensitive Networking* (in German)
Wolfgang Schulte
VDE Verlag, 2020
ISBN 978-3-8007-5078-8
- ▶ *Time-Sensitive Networking For Dummies, Belden/Hirschmann Special Edition* (in English)
Oliver Kleineberg, Axel Schneider
Wiley, 2018
ISBN 978-1-119-52791-6 (Print), ISBN 978-1-119-52799-2 (eBook)
- ▶ *IPv6: Grundlagen - Funktionalität - Integration* (in German)
Silvia Hagen
Sunny Connection, 3rd edition, 2016
ISBN 978-3-9522942-3-9 (Print), ISBN 978-3-9522942-8-4 (eBook)
- ▶ *IPv6 Essentials* (in English)
Silvia Hagen
O'Reilly, 3rd edition, 2014
ISBN 978-1-449-31921-2 (Print)
- ▶ *TCP/IP Illustrated, Volume 1: The Protocols (2nd Edition)* (in English)
W. R. Stevens, Kevin R. Fall
Addison Wesley, 2011
ISBN 978-0-321-33631-6
- ▶ *Measurement, Control and Communication Using IEEE 1588* (in English)
John C. Eidson
Springer, 2006
ISBN 978-1-84628-250-8 (Print), ISBN 978-1-84628-251-5 (eBook)
- ▶ *TCP/IP: Der Klassiker. Protokollanalyse. Aufgaben und Lösungen* (in German)
W. R. Stevens
Hüthig-Verlag, 2008
ISBN 978-3-7785-4036-7
- ▶ *Optische Übertragungstechnik in der Praxis* (in German)
Christoph Wrobel
Hüthig-Verlag, 3rd edition, 2004
ISBN 978-3-8266-5040-6

B.2 Maintenance

Hirschmann is continually working on improving and developing their software. Check regularly if there is an updated version of the device software that provides you with additional benefits. You find information and software downloads on the Hirschmann product pages on the Internet at www.hirschmann.com.

B.3 Management Information Base (MIB)

The Management Information Base (MIB) is designed in the form of an abstract tree structure.

The branching points are the object classes. The "leaves" of the MIB are called generic object classes.

When this is required for unique identification, the generic object classes are instantiated, that means the abstract structure is mapped onto reality, by specifying the port or the source address.

Values (integers, time ticks, counters or octet strings) are assigned to these instances; these values can be read and, in some cases, modified. The object description or object ID (OID) identifies the object class. The subidentifier (SID) is used to instantiate them.

Example:

The generic object class `hm2PSState` (OID = `1.3.6.1.4.1.248.11.11.1.1.1.2`) is the description of the abstract information `power supply status`. However, it is not possible to read any value from this, as the system does not know which power supply is meant.

Specifying the subidentifier `2` maps this abstract information onto reality (instantiates it), thus identifying it as the operating status of power supply `2`. A value is assigned to this instance and can be read. The instance `get 1.3.6.1.4.1.248.11.11.1.1.1.2.1` returns the response `1`, which means that the power supply is ready for operation.

Definition of the syntax terms used:	
Integer	An integer in the range $-2^{31}..2^{31}-1$
IP address	<code>xxx.xxx.xxx.xxx</code> (xxx = integer in the range <code>0..255</code>)
MAC address	12-digit hexadecimal number in accordance with ISO/IEC 8802-3
Object Identifier	<code>x.x.x.x...</code> (for example <code>1.3.6.1.1.4.1.248...</code>)
Octet String	ASCII character string
PSID	Power supply identifier (number of the power supply unit)
TimeTicks	Stopwatch, Elapsed time = numerical value / 100 (in seconds) numerical value = integer in the range $0..2^{32}-1$
Timeout	Time value in hundredths of a second time value = integer in the range $0..2^{32}-1$
Type field	4-digit hexadecimal number in accordance with ISO/IEC 8802-3
Counter	Integer ($0..2^{32}-1$), when certain events occur, the value increases by <code>1</code> .

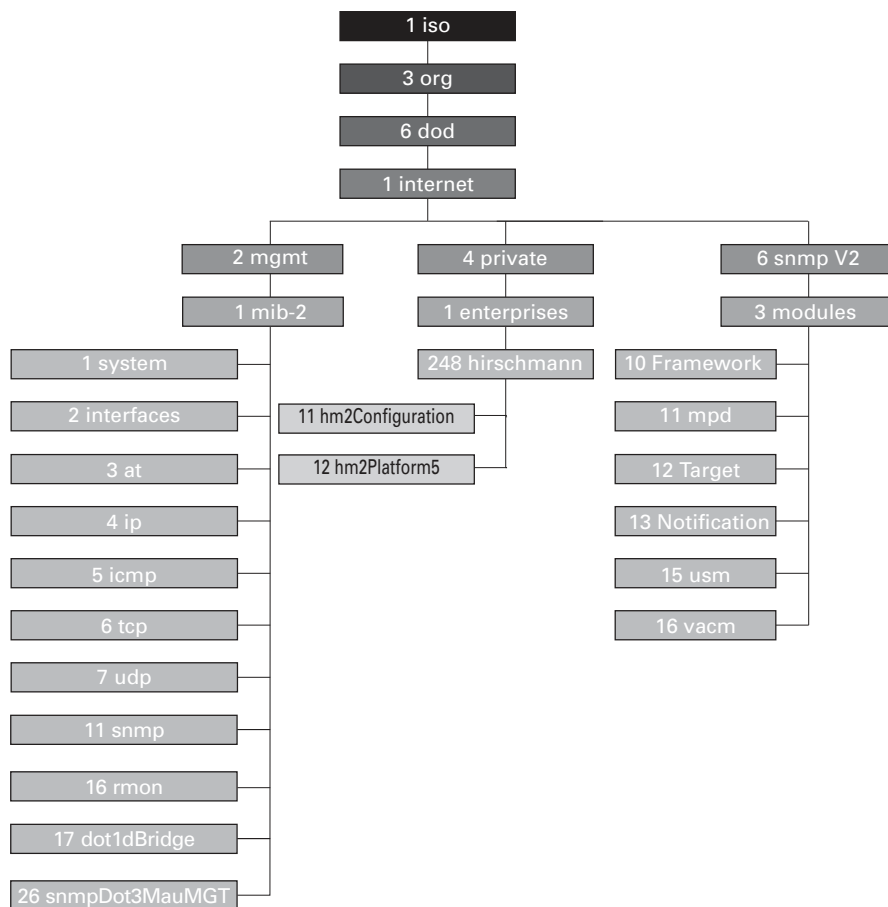

Figure 75: Tree structure of the Hirschmann MIB

When you have downloaded updated device software from the product pages on the Internet, the ZIP archive contains not only the device software but also the MIBs.

B.4 List of RFCs

RFC 768	UDP
RFC 783	TFTP
RFC 791	IP
RFC 792	ICMP
RFC 793	TCP
RFC 826	ARP
RFC 854	Telnet
RFC 855	Telnet Option
RFC 951	BOOTP
RFC 1112	IGMPv1
RFC 1157	SNMPv1
RFC 1155	SMIv1
RFC 1212	Concise MIB Definitions
RFC 1213	MIB2
RFC 1493	Dot1d
RFC 1542	BOOTP-Extensions
RFC 1643	Ethernet-like -MIB
RFC 1757	RMON
RFC 1867	Form-Based File Upload in HTML
RFC 1901	Community based SNMP v2
RFC 1905	Protocol Operations for SNMP v2
RFC 1906	Transport Mappings for SNMP v2
RFC 1945	HTTP/1.0
RFC 2068	HTTP/1.1 protocol as updated by draft-ietf-http-v11-spec-rev-03
RFC 2131	DHCP
RFC 2132	DHCP-Options
RFC 2233	The Interfaces Group MIB using SMI v2
RFC 2236	IGMPv2
RFC 2246	The TLS Protocol, Version 1.0
RFC 2346	AES Ciphersuites for Transport Layer Security
RFC 2365	Administratively Scoped IP Multicast
RFC 2578	SMIv2
RFC 2579	Textual Conventions for SMI v2
RFC 2580	Conformance statements for SMI v2
RFC 2613	SMON
RFC 2618	RADIUS Authentication Client MIB
RFC 2620	RADIUS Accounting MIB
RFC 2674	Dot1p/Q
RFC 2818	HTTP over TLS
RFC 2851	Internet Addresses MIB

RFC 2863	The Interfaces Group MIB
RFC 2865	RADIUS Client
RFC 2866	RADIUS Accounting
RFC 2868	RADIUS Attributes for Tunnel Protocol Support
RFC 2869	RADIUS Extensions
RFC 2869bis	RADIUS support for EAP
RFC 2933	IGMP MIB
RFC 3164	The BSD syslog protocol
RFC 3376	IGMPv3
RFC 3410	Introduction and Applicability Statements for Internet Standard Management Framework
RFC 3411	An Architecture for Describing Simple Network Management Protocol (SNMP) Management Frameworks
RFC 3412	Message Processing and Dispatching for the Simple Network Management Protocol (SNMP)
RFC 3413	Simple Network Management Protocol (SNMP) Applications
RFC 3414	User-based Security Model (USM) for version 3 of the Simple Network Management Protocol (SNMPv3)
RFC 3415	View-based Access Control Model (VACM) for the Simple Network Management Protocol (SNMP)
RFC 3418	Management Information Base (MIB) for the Simple Network Management Protocol (SNMP)
RFC 3580	802.1X RADIUS Usage Guidelines
RFC 3584	Coexistence between Version 1, Version 2, and Version 3 of the Internet-standard Network Management Framework
RFC 4022	Management Information Base for the Transmission Control Protocol (TCP)
RFC 4113	Management Information Base for the User Datagram Protocol (UDP)
RFC 4188	Definitions of Managed Objects for Bridges
RFC 4251	SSH protocol architecture
RFC 4291	IPv6 Addressing Architecture
RFC 4252	SSH authentication protocol
RFC 4253	SSH transport layer protocol
RFC 4254	SSH connection protocol
RFC 4293	Management Information Base for the Internet Protocol (IP)
RFC 4318	Definitions of Managed Objects for Bridges with Rapid Spanning Tree Protocol
RFC 4330	Simple Network Time Protocol (SNTP) Version 4 for IPv4, IPv6 and OSI
RFC 4363	Definitions of Managed Objects for Bridges with Traffic Classes, Multicast Filtering, and Virtual LAN Extensions
RFC 4541	Considerations for Internet Group Management Protocol (IGMP) and Multicast Listener Discovery (MLD) Snooping Switches
RFC 4836	Definitions of Managed Objects for IEEE 802.3 Medium Attachment Units (MAUs)
RFC 4861	Neighbor Discovery for IPv6
RFC 6221	Leightweight DHCPv6 Relay Agent
RFC 8200	IPv6 Specification
RFC 8415	DHCPv6

B.5 Underlying IEEE Standards

IEEE 802.1AB	Station and Media Access Control Connectivity Discovery
IEEE 802.1D	MAC Bridges (switching function)
IEEE 802.1Q	Virtual LANs (VLANs, MRP, Spanning Tree)
IEEE 802.1X	Port Authentication
IEEE 802.3	Ethernet
IEEE 802.3ac	VLAN Tagging
IEEE 802.3x	Flow Control
IEEE 802.3af	Power over Ethernet

B.6 Underlying IEC Norms

IEC 62439	High availability automation networks MRP – Media Redundancy Protocol based on a ring topology
-----------	---

B.7 Underlying ANSI Norms

ANSI/TIA-1057 Link Layer Discovery Protocol for Media Endpoint Devices, April 2006

B.8 Technical Data

15.3.6 Switching

Size of the MAC address table (forwarding database) (incl. static filters)	16384
Max. number of statically set-up MAC address filters	100
Max. number of MAC address filters learnable through IGMP Snooping	1024
Max. number of MAC address entries (MMRP)	64
Number of priority queues	8 Queues
Port priorities that can be set	0..7
MTU (Max. allowed length of packets a port can receive or transmit)	12288 Bytes

15.3.7 VLAN

VLAN ID range	1..4042
Number of VLANs	max. 512 simultaneously per device max. 512 simultaneously per port

15.3.8 Access Control Lists (ACL)

Max. number of ACLs	100
Max. number of rules per ACL	1023
Max. number of rules per port	1023
Number of total configurable rules	8184 (8 × 1023)
Max. number of VLAN assignments	24
Max. number of rules which log an event	128
Max. number of Ingress rules	1792

B.9 Copyright of integrated Software

The product contains, among other things, Open Source Software files developed by third parties and licensed under an Open Source Software license.

You can find the license terms in the Graphical User Interface in the [Help > Licenses](#) dialog.

B.10 Abbreviations used

ACA	Name of the external memory
ACL	Access Control List
BOOTP	Bootstrap Protocol
CLI	Command Line Interface
DHCP	Dynamic Host Configuration Protocol
DHCPv6	Dynamic Host Configuration Protocol for IPv6
DUID	DHCP Unique Identifier
EUI	Extended Unique Identifier
FDB	Forwarding Database
GUI	Graphical User Interface
HTTP	Hypertext Transfer Protocol
HTTPS	Hypertext Transfer Protocol Secure
ICMP	Internet Control Message Protocol
IEEE	Institute of Electrical and Electronics Engineers
IGMP	Internet Group Management Protocol
IP	Internet Protocol
IPv6	Internet Protocol version 6
LDRA	Lightweight DHCPv6 Relay Agent
LED	Light Emitting Diode
LLDP	Link Layer Discovery Protocol
MAC	Media Access Control
MIB	Management Information Base
MRP	Media Redundancy Protocol
NDP	Neighbor Discovery Protocol
NMS	Network Management System
PC	Personal Computer
PTP	Precision Time Protocol
QoS	Quality of Service
RFC	Request For Comment
RM	Redundancy Manager
RSTP	Rapid Spanning Tree Protocol
SCP	Secure Copy
SFP	Small Form-factor Pluggable
SFTP	SSH File Transfer Protocol
SNMP	Simple Network Management Protocol
SNTP	Simple Network Time Protocol
TCP	Transmission Control Protocol
TFTP	Trivial File Transfer Protocol
TP	Twisted-pair
UDP	User Datagram Protocol

URL	Uniform Resource Locator
UTC	Coordinated Universal Time
VLAN	Virtual Local Area Network

C Index

0-9	
802.1X	64
A	
Access roles	67
Access security	119
Advanced Information, MRP	192
Advanced mode	191, 193
Aging time	153
Alarm	221, 348
Alarm messages	219
Alarm setting	295
Alternate port	206, 212
APNIC	42
ARIN	42
ARP	44
Authentication list	64
Automatic configuration	120
B	
Backup port	207, 212
Bandwidth	170
Best Master Clock algorithm	89, 91
BOOTP	41
Boundary clock (PTP)	88
BPDU	201
BPDU guard	211, 212
Bridge Identifier	198
Bridge Protocol Data Unit	201
C	
CIDR	44
CIP	275
Classless inter domain routing	44
Closed circuit	230
Command Line Interface	18
Command tree	26
Common Industrial Protocol	275
Configuration file	58
Configuration modifications	219
Conformity class	293

D	
Data stream monitoring Port Mirroring	249
Data traffic	135
Delay (PTP)	89
Delay measurement (PTP)	89
Delay time (MRP)	191
Denial of Service	135
Designated bridge	206
Designated port	206, 211
Destination table	219
Device description language	293
Device replacement	15
Device status	222
DHCP	41
DHCP L2 Relay	258
DHCP server	80, 85, 255, 355, 358
DHCPv6	59
Diameter (Spanning Tree)	200
DiffServ	159
Disabled port	207
DoS	135
DSCP	159, 168
E	
Edge port	206, 211
EDS	275
Engineering Station	347
Engineering system	295
EtherNet/IP website	275
Event log	245
F	
FAQ	387
FDB (MAC address table)	149
First installation	41
Flow control	170
G	
Gateway	42, 51
Generic Ethernet Module	276
Generic object classes	369
Global Config mode	24
Grandmaster (PTP)	89, 91
GSD	293, 295, 299
GSD file	299
GSDML	293
H	
HaneWin	355, 358
Hardware reset	219
HiDiscovery	41
HiView	63
Host address	42

I	
IANA	42
IAS	64
Icon	295
IEEE MAC address	239
IEEE 802.1X	64
IGMP snooping	153, 275
Industrial HiVision	13
Instantiation	369
Integrated Authentication Server	64
IP address	42, 51, 58
IP header	159, 161
IPv6 address	46
IPv6 address types	47
ISO/OSI layer model	44
L	
LACNIC	42
Leave message	153
Link Aggregation	188
Link monitoring	222, 230
Login dialog	17
Loop guard	212, 214
M	
MAC address filter	149
MAC destination address	44
MAC address table (forwarding database)	149
MaxAge	201
Memory (RAM)	95
Message	219
Mode	120
MRP	188, 190, 191
MRP Advanced Information	192
MRP Packet Prioritization	193
MRP Packets	192
Multicast	153
N	
Netmask	42, 51
Network load	197, 198
Network management	58
Network structure	190
Non-volatile memory (NVM)	95
NVM (non-volatile memory)	95
O	
Object classes	369
Object description	369
Object ID	369
ODVA	275
ODVA website	275
OpenSSH-Suite	18
Operation monitoring	230
Option 82	358
Ordinary clock (PTP)	89

P	
Password	20, 22
Path costs	199, 202
PC Worx	295
Polling	219
Port Identifier	198
Port Mirroring	249
Port priority	167
Port roles (RSTP)	206
Port State	207
Prefix length	47
Priority	161
Priority queue	162
Priority tagged frames	161
Privileged Exec mode	23
PROFIBUS Organization	293
Protection functions (guards)	211
PTP	79
PTP domain	90
PuTTY	18
Q	
QoS	160
Query	153
R	
RADIUS	64
RAM (memory)	95
Rapid Spanning Tree	188, 206
Real time	159
Reconfiguration	198
Reconfiguration time (MRP)	191
Record	348
Redundancy	197
Reference time source	79, 85, 89, 91
Relay contact	230
Remote diagnostics	230
Report	242
Report message	153
Request Packet Interval	276
RFC	371
Ring	190
Ring Manager	190
RIPE NCC	42
RM (Ring Manager)	190
RMON probe	249
Root bridge	202
Root guard	211, 214
Root path	203, 204
Root path cost	198
Root port	206, 212
Router	42
Router Advertisement Daemon	56, 60
RPI	276
RST BPDU	206, 208
RSTP	209

S

Secure Shell (SSH)	18
Segmentation	219
Serial interface	21
Service	242
Service Shell	23
Service Shell deactivation	36
Setting the time	79
SFP module	238
Signal contact	230
SNMP	219
SNMP trap	219, 221
SNTP	79
Software version	109
SSH (Secure Shell)	18
Starting the graphical user interface	17
Store-and-forward	149
STP-BPDU	201
Strict Priority	162
Subidentifier	369
Subnet	51
Symbol	275, 299
System requirements (Graphical User Interface)	17
System time	79

T

Tab Completion	33
TCN guard	212, 214
TCP/IP	275, 293
Technical questions	387
Threshold value	295
TIA Portal	295
Topology Change flag	212
ToS	159, 161
Traffic class	162, 167
Traffic shaping	168
Training courses	387
Transmission reliability	219
Transparent clock (PTP)	88
Trap	219, 221
Trap destination table	219
Tree structure (Spanning Tree)	202, 205
Type of Service	161

U

UDP/IP	275, 293
User Exec mode	23
User name	19, 21
Utilization	197, 198

V

Video	162
VLAN	173
VLAN mode	23
VLAN priority	166
VLAN tag	161, 173
VoIP	162
VT100	21

W
Weighted Fair Queuing 162
Weighted Round Robin 162

D Technical support

Technical questions

For technical questions, please contact any Hirschmann dealer in your area or Hirschmann directly. You find the addresses of our partners on the Internet at www.belden.com.

For technical support, visit hirschmann-support.belden.com. This site also includes a free of charge knowledge base and a software download section.

Technical Documents

The current manuals and operating instructions for Hirschmann products are available at doc.hirschmann.com.

Customer Innovation Center

The Customer Innovation Center is ahead of its competitors on three counts with its complete range of innovative services:

- ▶ Consulting incorporates comprehensive technical advice, from system evaluation through network planning to project planning.
- ▶ Training offers you an introduction to the basics, product briefing and user training with certification. You find the training courses on technology and products currently available at www.belden.com/solutions/customer-innovation-center.
- ▶ Support ranges from the first installation through the standby service to maintenance concepts.

With the Customer Innovation Center, you decide against any compromise in any case. Our client-customized package leaves you free to choose the service components you want to use.

E Readers' Comments

What is your opinion of this manual? We are constantly striving to provide as comprehensive a description of our product as possible, as well as important information to assist you in the operation of this product. Your comments and suggestions help us to further improve the quality of our documentation.

Your assessment of this manual:

	Very Good	Good	Satisfactory	Mediocre	Poor
Precise description	<input type="radio"/>	<input type="radio"/>	<input type="radio"/>	<input type="radio"/>	<input type="radio"/>
Readability	<input type="radio"/>	<input type="radio"/>	<input type="radio"/>	<input type="radio"/>	<input type="radio"/>
Understandability	<input type="radio"/>	<input type="radio"/>	<input type="radio"/>	<input type="radio"/>	<input type="radio"/>
Examples	<input type="radio"/>	<input type="radio"/>	<input type="radio"/>	<input type="radio"/>	<input type="radio"/>
Structure	<input type="radio"/>	<input type="radio"/>	<input type="radio"/>	<input type="radio"/>	<input type="radio"/>
Comprehensive	<input type="radio"/>	<input type="radio"/>	<input type="radio"/>	<input type="radio"/>	<input type="radio"/>
Graphics	<input type="radio"/>	<input type="radio"/>	<input type="radio"/>	<input type="radio"/>	<input type="radio"/>
Drawings	<input type="radio"/>	<input type="radio"/>	<input type="radio"/>	<input type="radio"/>	<input type="radio"/>
Tables	<input type="radio"/>	<input type="radio"/>	<input type="radio"/>	<input type="radio"/>	<input type="radio"/>

Did you discover any errors in this manual?
If so, on what page?

Suggestions for improvement and additional information:

General comments:

Sender:

Company / Department:

Name / Telephone number:

Street:

Zip code / City:

E-mail:

Date / Signature:

Dear User,

Please fill out and return this page

- ▶ as a fax to the number +49 (0)7127/14-1600 or
- ▶ per mail to
Hirschmann Automation and Control GmbH
Department IRD-NT
Stuttgarter Str. 45-51
72654 Neckartenzlingen
Germany



HIRSCHMANN

A **BELDEN** BRAND