

# Manual

## LioN-P PROFINET IO-Link Master

**0980 ESL 308-121, 0980 ESL 398-121**  
**0980 ESL 309-121, 0980 ESL 399-121**  
**0980 ESL 309-121-EEC, 0980 ESL 399-121-EEC**  
**0980 ESL 109-121, 0980 ESL 199-121**  
**0980 ESL 109-332, 0980 ESL 199-332**  
**0980 ESL 109-122, 0980 ESL 199-122**  
**0980 ESL 109-331, 0980 ESL 199-331**

# Contents

<b>1 About this manual</b>	<b>7</b>
1.1 General information	7
1.2 Explanation of symbols	8
1.2.1 Use of danger information	8
1.2.2 Use of general information	8
1.3 Version information	9
<b>2 Safety instructions</b>	<b>10</b>
2.1 Intended use	10
2.2 Qualified personnel	11
<b>3 Designations and synonyms</b>	<b>12</b>
<b>4 System description</b>	<b>13</b>
4.1 PROFINET product features	13
4.2 IO port features	16
4.3 Integrated web server	17
4.4 Other features	19
4.5 Product overview	20
<b>5 Assembly and wiring</b>	<b>22</b>
5.1 General information	22
5.2 Outer dimensions	23
5.2.1 Module 0980 ESL 3x8-121 & ESL 3x9-121	23

5.2.2	Module 0980 ESL 1x9-121	24
5.2.3	Module 0980 ESL 1x9-332	25
5.2.4	Module 0980 ESL 1x9-122	26
5.2.5	Module 0980 ESL 1x9-331	27
5.3	Port assignments	28
5.3.1	PROFINET ports, M12 socket, 4-pin, D-coded	28
5.3.2	Power supply with M12 power L-coded	29
5.3.3	PROFINET and power supply with M12 Hybrid	30
5.3.4	IO ports as M8 or M12 sockets	31
5.3.4.1	IO-Link Type A	31
5.3.4.2	IO-Link Type B	32

## **6 Starting operation 34**

6.1	GSDML file	34
6.2	MAC addresses	34
6.3	State on delivery	35
6.4	Configuration of the LioN-P PROFINET IO modules in STEP 7	35
6.4.1	Assigning a unique device name	36
6.4.2	Assigning a device name to a LioN-P module	36
6.4.3	Configuring the IO-Link channels	37
6.4.3.1	Deleting the configuration of an IO-Link channel	38
6.4.3.2	Creating an IO-Link channel configuration	40
6.4.4	Parameterization of the IO-Link channels	42
6.4.4.1	IOL Parameter storage	42
6.4.4.2	IOL Device Validation	45
6.4.4.3	Fail Safe Configuration (for outputs only)	46
6.4.5	Parameterization of the status/control module	48
6.4.5.1	General Device Settings	48
6.4.5.2	General Diagnosis Settings	49
6.4.5.3	Fail Safe Value (DO-Mode)	50
6.4.6	Surveillance Timeout Configuration (LioN-P 60 devices)	51
6.4.7	Digital input logic	52
6.4.8	Digital-IO mode for Ch. B/Pin 2	53
6.4.8.1	Digital-IO mode for Ch. B/Pin 2 (LioN-P 30 devices)	53

6.4.8.2 Digital-IO mode for Ch. B/Pin 2 (LioN-P 60 devices)	53
6.5 IO-Link Device Parameterization	55
6.5.1 SIEMENS IO-Link library	55
6.6 SNMP	57
6.7 Media Redundancy Protocol (MRP)	58
6.8 Identification & maintenance functions (I&M)	61
6.8.1 Supported I&M features	62
6.8.1.1 Module-specific I&M features	62
6.8.1.2 IO-Link Master I&M functions	63
6.8.1.3 IO-Link Device I&M functions	65
6.8.2 Reading and writing I&M data	65
6.8.2.1 I&M Read Record	66
6.8.2.2 I&M Write Record	67
6.9 Fast Start-Up (FSU) / Prioritized Start-Up	69

## **7 Bit assignment** **70**

7.1 Process data Status and Control module, slot 1/sub-slot 1	70
7.1.1 Digital IO mapping mode 1 (default mapping)	70
7.1.1.1 Input data of the Status/Control modules	70
7.1.1.2 Output data of the Status/Control modules (except 0980 ESL 3x8-121)	72
7.1.1.3 Output data of the Status/Control modules for 0980 ESL 3x8-121	74
7.1.2 Digital IO mapping mode 2 (E2C compatibility)	75
7.1.2.1 Input data of the Status/Control modules	75
7.1.2.2 Output data of the Status/Control modules (except 0980 ESL 3x8-121)	77
7.1.2.3 Output data of the Status/Control modules for 0980 ESL 3x8-121	79
7.2 Process data IO-Link ports, slot 1/sub-slot 2 - sub-slot 9	80

## **8 Diagnostics processing** **81**

8.1 Error of the system/sensor power supply	81
---	----

8.2 Error of the auxiliary/actuator power supply	81
8.3 Overload/short-circuit of the IO port sensor supply outputs	82
8.4 Overload/short circuit of the digital 500 mA outputs	83
8.5 Overload/short circuit of the digital outputs	83
8.6 Overload/short circuit of the Type B port aux. power supply	85
8.6.1 For LioN-P 30 devices	85
8.6.2 For LioN-P 60 devices	85
8.7 IO-Link C/Q error	86
8.8 IO-Link Device Diagnostics	87

## **9 Port Configuration Tool** **89**

## **10 The integrated web server** **91**

10.1 The Status page	92
10.2 The Ports page	95
10.3 The System page	96
10.4 The User page	98

## **11 Technical data** **99**

11.1 General	99
11.2 PROFINET protocol	100
11.3 Power supply of the module electronics/sensors	101
11.4 Power supply of the type B ports (auxiliary supply)	102
11.5 IO-Link Master Ports (X1 - X8, Ch. A / C/Q / Pin 4)	102
11.5.1 Configured as a digital input	103
11.5.2 Configured as a digital output (except 0980 ESL 3x8-121)	103
11.5.3 Configured as an IO-Link port in COM mode	104
11.6 Digital inputs (X1 – X4, type A ports, Ch. B/Pin 2)	104
11.7 LioN-P 60: $U_{Aux}$ config. as a digital output (X5 - X8, type B ports, Ch. B/Pin 2)	106
11.8 LioN-P 30: $U_{Aux}$ (X5 - X8)	107

11.9 Differences between 0980 ESL 3x8-121 and 0980 ESL 3x9-121	108
11.10 LEDs	109

## **12 Accessories** **111**

# 1 About this manual

## 1.1 General information

Please read the assembly and operating instructions in this manual carefully before starting up the LioN-P modules with PROFINET IO interface. Keep the manual where it is accessible to all users.

The texts, figures, diagrams, and examples used in this manual are used exclusively to explain how to operate and apply the LioN-P modules with PROFINET IO interface.

Please contact us if you have any detailed questions on installing and starting up the devices.

Belden Deutschland GmbH  
– Lumberg Automation™ –  
Im Gewerbepark 2  
58579 Schalksmühle  
Germany  
[support-automation@belden.com](mailto:support-automation@belden.com)  
[www.lumberg-automation.com](http://www.lumberg-automation.com)

Belden Deutschland GmbH – Lumberg Automation™ – reserves the right to make technical changes or changes to this manual at any time without notice.

## 1.2 Explanation of symbols

### 1.2.1 Use of danger information

Danger information is denoted as follows:



**Danger:** Means that death, serious physical injury or substantial damage to property will occur if the required safety measures are not taken.



**Warning:** Means that death, serious physical injury or substantial damage to property can occur if the required safety measures are not taken.



**Caution:** Means that minor physical injury or damage to property can occur if the required safety measures are not taken.

### 1.2.2 Use of general information

General information is denoted as follows:



**Attention:** Contains important information on the product, on how to manage the product, or on the respective section of the documentation to which your special attention is being drawn.



## 1.3 Version information

Index	Created	Changed
Version number	Version 1.0	Version 1.1
Date	02-09-2016	06-14-2016
Name/department	MJ / 02RH-NT	GL / 02RH-NT

Index	Changed	Changed
Version number	Version 2.0	Version 2.1
Date	11-03-2016	06-10-2017
Name/department	MJ / 02RH-NT	AG / 02RH-NT

Index	Changed	Changed
Version number	Version 2.2	Version 2.3
Date	August 2019	November 2019
Name/department	JGA/R&D	JGA/R&D

*Table 1: Overview of manual revisions*

## 2 Safety instructions

### 2.1 Intended use

The devices described in this manual are decentralized input/output assemblies on a PROFINET IO network.

We adhere to all safety standards when developing, producing, testing, and documenting our products. When you adhere to the handling specifications and safety instructions described for the configuration, assembly, and correct operation, there should not normally be any risks for people or equipment.

The modules fulfill the requirements of the EMC guidelines (89/336/EEC, 93/68/EEC and 93/44/EEC) and the low voltage guideline (73/23/EEC).

The modules are designed to be used in the industrial sector. The industrial environment is distinguished by the fact that the consumer is not connected directly to the public low voltage network. Additional measures are required for use in residential areas or in business and commercial sectors.



**Attention:** This equipment may cause radio interference in residential areas. In this case the operator may be requested to carry out appropriate measures.

The proper and safe operation of this product depends on proper transportation, storage, assembly, and installation, and careful operation.

A completely assembled device housing is required for the proper operation of the modules. Only connect devices to the modules that fulfill the requirements of EN 61558-2-4 and EN 61558-2-6.

During the configuration, installation, start-up, maintenance, and testing of the devices, adhere to the safety and accident-prevention guidelines for the specific application.

Only install cables and accessories that fulfill the requirements and regulations for safety, electromagnetic compatibility, and, where applicable, telecommunication end devices, as well as the specification information.

Information on which cables and accessories are permitted for the installation can be obtained from Lumberg Automation™ or is contained in this manual.

## 2.2 Qualified personnel

The configuration, installation, start-up, maintenance, and testing of the devices may only be performed by a qualified electrician who is familiar with the safety standards of the automation technology.

The personnel requirements are based on the requirement profiles described by ZVEI, VDMA, or equivalent organizations.

Only electricians who are familiar with the content of this manual are authorized to install and maintain the devices described. These are persons who

- ▶ based on their technical training, knowledge, and experience, and their knowledge of the pertinent standards, can evaluate the work to be carried out and identify any potential risks or
- ▶ based on working for several years in a related sector, have the same level of knowledge as they would have from the relevant technical training.

Only Belden Deutschland GmbH – Lumberg Automation™ – is permitted to make changes to the hardware or software of the products that go beyond the scope of this manual.



**Warning:** Making unqualified changes to the hardware or software, or non-adherence to the warning information contained in this manual, can result in serious personal injury or damage to equipment.

## 3 Designations and synonyms

EEC	Extended Environmental Conditions
LioN-P 30	LioN-P devices with a width of 30mm
LioN-P 60	LioN-P devices with a width of 60mm
Type A	IO-Link port specification (Class A)
Type B	IO-Link port specification (Class B)
IO port	X1 - X8
IO port pin 4 (C/Q)	Channel A of X1 - X8
IO port pin 2	Channel B of X1 - X8
$U_{AUX}$	$U_{Auxiliary}$ <sup>1)</sup> .

- 1).  $U_{Auxiliary}$  is the auxiliary power supply to the IO-Link type B ports X5 - X8 or the actuator power supply to the digital 2.0 A outputs on ports X5 - X8 (LioN-P 60).

## 4 System description

LioN modules (Lumberg Automation™ Input/Output Network) function as the interface in an industrial fieldbus system: They enable a central controller on the management level to communicate with the decentralized sensors and actuators on the field level. The line or ring topologies that they can be used to create not only ensure reliable data communication but also significantly reduce the cables required and thus also the costs for installation and maintenance. They additionally enable easy, quick extension.

The modules of the LioN-P series have been substantially reduced in size compared with the well-known LioN-R family; the modules have a very rugged metal housing made of die-cast zinc. Housing variants with widths of 30 mm and 60 mm and different connector types are available. The completely cast device housing protects the module electronics from environmental effects and allows the device to be used in a wide temperature range. Despite the sturdy construction, the modules have compact dimensions and a low weight. They are especially suitable for use in machines and installations with a moderate IO concentration over separate assemblies.

### 4.1 PROFINET product features

#### Data connection

The connection options provided by the module series are the widely-used M12 connector with D coding and the M12 hybrid connector for the PROFINET IO network.

The connectors are also color-coded to prevent the ports from being mixed up.

#### Data transmission rates

Featuring a transmission rate of up to 100 MBit/s, the PROFINET modules can handle both fast transmission of IO data and transmission of larger volumes of data.

## **PROFINET IO Device RT**

The LioN-P IO-Link master modules support PROFINET IO Device RT (real-time). This allows the transmission of time sensitive process data between network components in real-time communication.

## **PROFINET specification V2.3, Conformance Class C (CC-C)**

The LioN-P IO-Link master modules comply with PROFINET specification V2.3 and meet the requirements of Conformance Class C (CC-C).

## **Integrated switch**

The integrated Ethernet switch has two PROFINET ports and thus supports the establishment of a line or ring topology for the PROFINET IO network.

## **Media Redundancy Protocol**

The additionally implemented Media Redundancy Protocol (MRP) enables the design of a highly available network infrastructure.

## **Fast Start-Up (FSU)**

Fast Start-Up is an accelerated start-up process that enables LioN-P/-R modules to start communicating on an PROFINET network after a very short time. This makes a faster tool change possible, for example. Thanks to the FSU feature, the modules are ready to operate in less than 1600 ms.

## **Shared Device**

With the shared device functionality, two controllers can access the same IO device via a PROFINET interface. This option is done by copying the configuration of the IO device into the first and second controller and assigning it to the second controller as shared device. (Refer to the PLC manual)

**DCP**

The master modules use the DCP protocol to automatically assign IP addresses.

**LLDP**

The LLDP protocol is used to detect devices in the vicinity (neighborhood detection).

**SNMP**

The SNMP protocol handles network component monitoring and communication between the master and device.

**Alarm and diagnostics messages**

The modules support extended PROFINET alarm and diagnostics messages.

**I&M functions**

Identification and maintenance data (I&M) means information stored on the module. The identification data consist of manufacturer details for the module and can only be read. The maintenance data consist of systemspecific details created during the course of configuration. The modules can be uniquely identified via the I&M data online.

The module-specific I&M functions I&M 0 - 4 for the network interface(Slot 0) and IO-Link master-specific I&M functions I&M 0 and I&M 99 (IO-Link master Directory) for the IO-Link ports (Slot 1) are supported.

**GSDML-based configuration and parameterization of the IO ports**

You have the option of configuring and parameterizing the IO ports on the master modules via GSDML.

## 4.2 IO port features

### The master modules support the IO-Link standard v1.1.

Parametrization of the IO-Link devices in PROFINET via Siemens IO\_LINK\_CALL function modules for Step7 and TIA Portal.

Parametrization of the IO-Link devices via TMG IO-Link Device Tool > V5. Usable as standalone PC-Application or callable via Siemens TIA Portal.

### 8 x IO-Link master ports

The modules have 4 type A ports with an additional hard-wired digital input on pin 2 of the IO port.

#### **Variants with a width of 30 mm:**

4 x type B ports with electrically isolated auxiliary power supply on pins 2 and 5 of the IO port with a total of 4A current.

#### **Variants with a width of 60 mm:**

4 x type B ports with electrically isolated auxiliary power supply for up to 2 A per port on pins 2 and 5 with a total of 8 A current.

The auxiliary power supply can optionally be configured as a digital output.



**Warning:** If modules with electric isolation and modules without electric isolation are used within the same system, the electric isolation of all connected modules is cancelled.

### IO-Link port connections

The IO-Link port connection option provided by the module series is the 5-pin M12 connector, or the 5-pin M8 connector.

### Parameter storage

The Parameter Storage function stores and monitors the parameters of the IO-Link device and IO-Link



master. The function thus gives you an easy option for replacing the IO-Link device or IO-Link master.

This is possible as of IO-Link specification V1.1 and only if the IO-Link device and the IO-Link master support the function.

### IO device parameterization

The IO-Link devices in PROFINET can be parameterized via the Siemens function module IO\_LINK\_CALL for **STEP 7** and the **TIA Portal**.

### LED

You can see the status of a port by the color of the matching LEDs and their flash pattern. For details on the meanings of the LED colors, please see section [LEDs](#) on page 109.

## 4.3 Integrated web server

### Network parameter display

The integrated web server provides the option of viewing network parameters such as the IP address, subnet mask and gateway.

### Displaying diagnostics

View diagnostics via the integrated web server.

### User management

Use the integrated web server for convenient management of all users.

### IO-Link device parameters

You can read the IO-Link device parameters via the integrated web server and write new parameters in single write mode (single write mode doesn't activate the automated parameter storage mechanism) to the modules.

### Force Mode

With the Force Mode output and input values can be set for implementation reasons.

## 4.4 Other features

### Interface protection

The modules have reverse polarity, short-circuit and overload protection for all interfaces.

### Failsafe

The modules support a failsafe function. This allows you to define the behavior of every single channel configured as an output in the case of an interruption or a loss of PROFINET communication.

### Color-coded connectors

Color-coded connectors help you avoid confusion in your cabling.

### IP protection classes 65/67/69k

The IP protection classes describe environmental influences that the modules can be exposed to without risk and without suffering damage, or causing a risk for the user.

Depending on the module, IP protection classes IP65, IP67 or IP69k are offered.

## 4.5 Product overview

The following IO-Link masters are available for the LioN-P system:

Article number	Product designation	Description	Power & Ethernet ports	IO ports	
934 878 005	0980 ESL 308-121	LioN-P M12-60, IO-Link Master SP - PROFINET	PWR - M12 L-coded,	8x M12 A-coded (Up to 4DO – 1.6 A)	
934 879 009	0980 ESL 398-121	LioN-P M12-60, IO-Link Master MP – PROFINET / EtherNet/IP	ETH – M12 D-coded		
934 878 004	0980 ESL 309-121	LioN-P M12-60, IO-Link Master SP - PROFINET	PWR - M12 L-coded,	8x M12 A-coded (Up to 8DO – 0.5A and up to 4DO – 2 A)	
934 878 050	0980 ESL 309-121-EEC				
934 879 004	0980 ESL 399-121	LioN-P M12-60, IO-Link Master MP – PROFINET / EtherNet/IP	ETH – M12 D-coded		
934 879 072	0980 ESL 399-121-EEC				
934 861 001	0980 ESL 109-121	LioN-P M12-30, IO-Link Master SP - PROFINET	PWR - M12 L-coded,		8x M12 A-coded
934 964 004	0980 ESL 199-121	LioN-P M12-30, IO-Link Master MP – PROFINET / EtherNet/IP	ETH – M12 D-coded		
934 840 001	0980 ESL 109-332	LioN-P M8-30, IO-Link Master SP - PROFINET	PWR - M12 Hybrid,	8x M8	
934 964 002	0980 ESL 199-332	LioN-P M8-30, IO-Link Master MP – PROFINET / EtherNet/IP	ETH – M12 Hybrid		

Article number	Product designation	Description	Power & Ethernet ports	IO ports
934 862 001	0980 ESL 109-331	LioN-P M12-30, IO-Link Master SP - PROFINET	PWR - M12 Hybrid,  ETH – M12 Hybrid	8x M12 A-coded
934 964 001	0980 ESL 199-331	LioN-P M12-30, IO-Link Master MP – PROFINET / EtherNet/IP		
934 857 001	0980 ESL 109-122	LioN-P M8-30, IO-Link Master SP - PROFINET	PWR - M12 L-coded,  ETH – M12 D-coded	8x M8
934 964 003	0980 ESL 199-122	LioN-P M8-30, IO-Link Master MP – PROFINET / EtherNet/IP		

*Table 2: Overview of module variants in the LioN-P series*

## 5 Assembly and wiring

### 5.1 General information

Mount the module on a flat surface using 2 screws (M4x 25/30). The torque required here is 1 Nm. Use washers for all fastening methods as per DIN 125.

**i** **Attention:** The modules have a ground connection with an M4 thread for the conduction of interference currents and the EMC immunity. This is labeled with the symbol for the ground and the designation "XE"

**i** **Attention:** Use a low-impedance connection to connect the module to the reference ground. When using a grounded mounting surface, you can make the connection directly via the fixing screws.

**i** **Attention:** If the mounting surface is ground-free, use a ground strap or a suitable PE line. Use an M4 screw to connect the ground strap or the PE line to the ground point and if possible put a washer and a toothed washer below the fixing screw.

## 5.2 Outer dimensions

### 5.2.1 Module 0980 ESL 3x8-121 & ESL 3x9-121

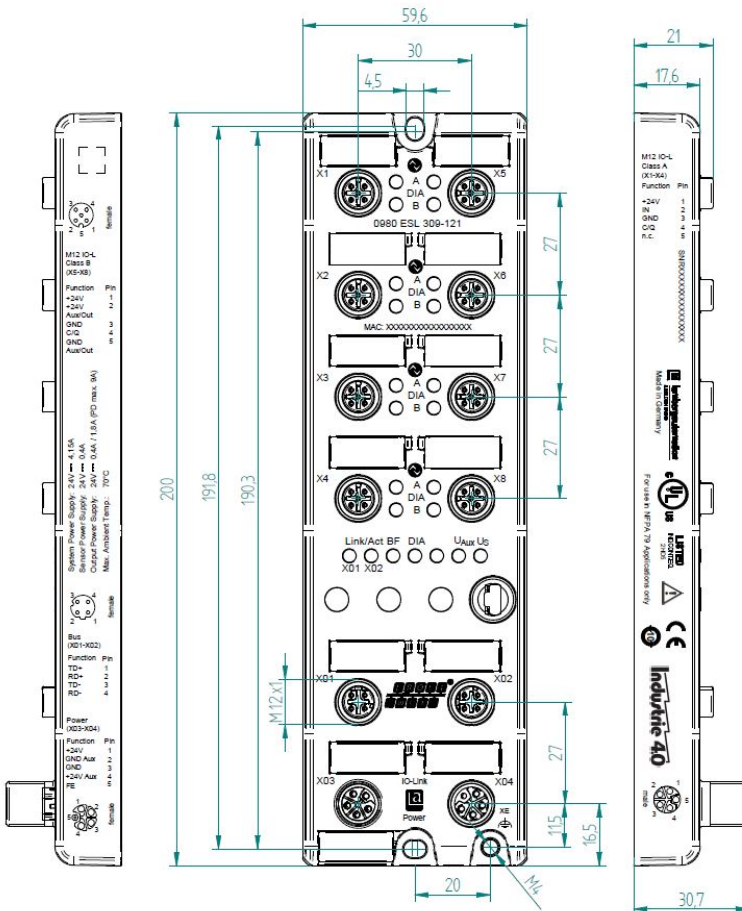

## 5.2.2 Module 0980 ESL 1x9-121

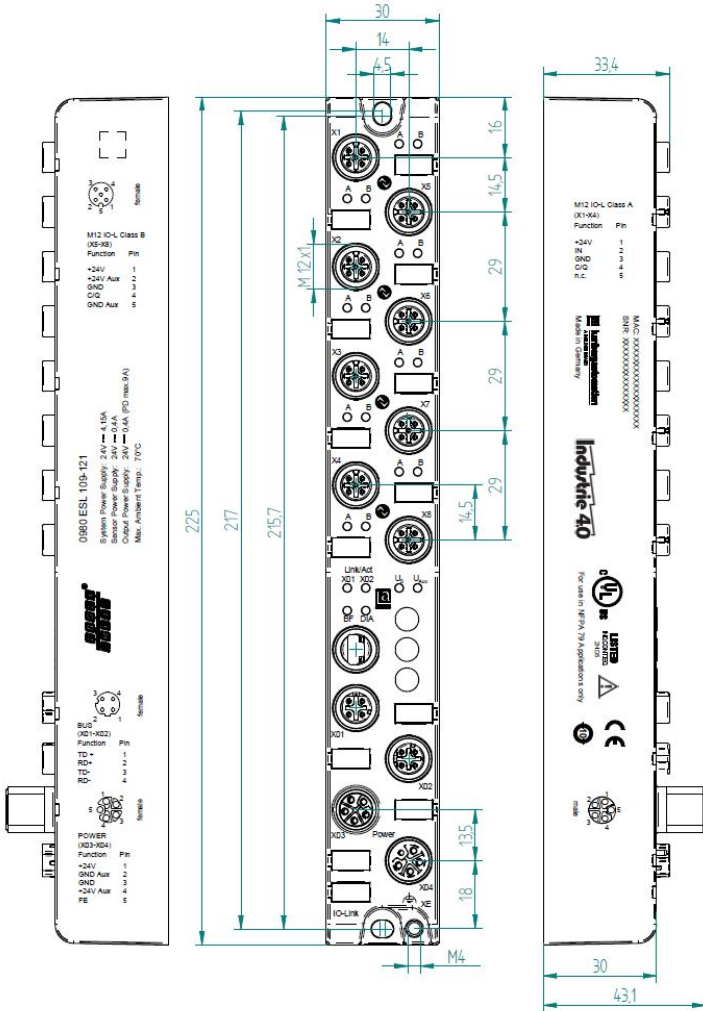



### 5.2.3 Module 0980 ESL 1x9-332

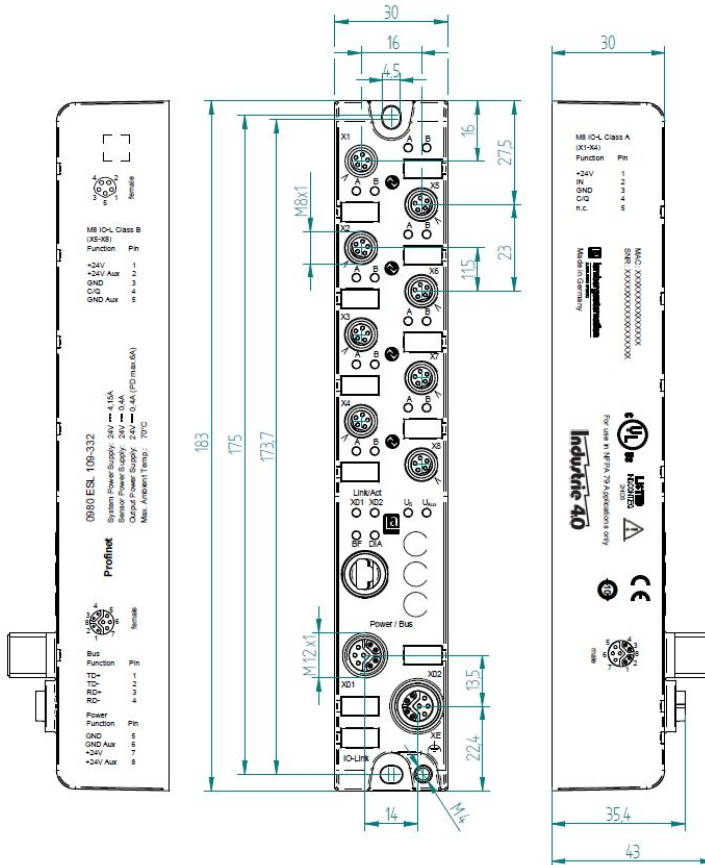



### 5.2.5 Module 0980 ESL 1x9-331

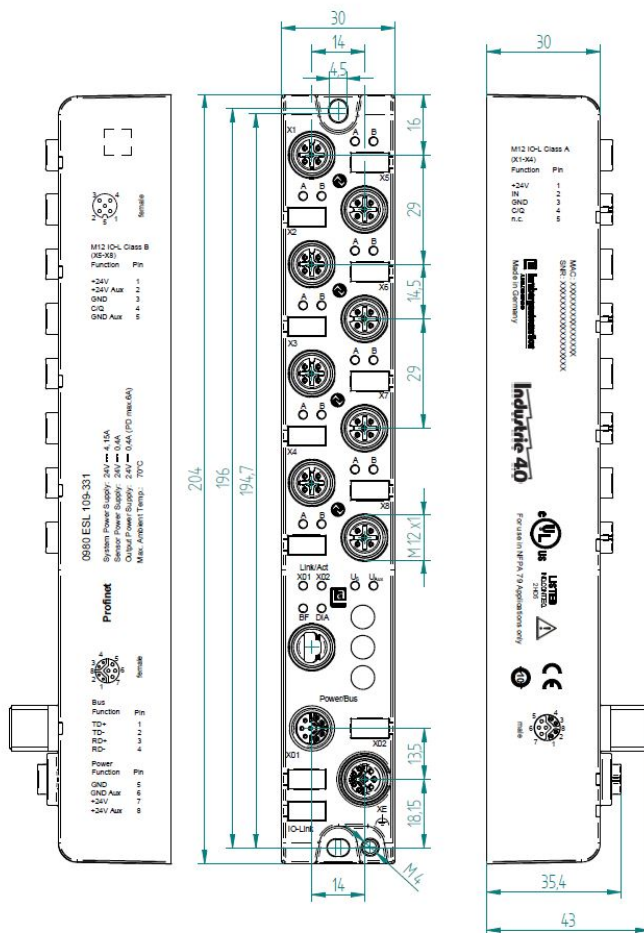



**Attention:** For U<sub>L</sub> application:

Be sure to use a UL-certified cable with a suitable evaluation to connect the devices (CYJV or PVVA). To program the control, please refer to the OEM information, and only use suitable accessories.

Only approved for interior use. Please note the maximum elevation of 2000 meters. Approved up to a maximum soiling level of 2.



**Warning:** Terminals, housings field-wired terminal boxes or components can exceed temperatures of 60° C.



**Warning:** For UL application (max. ambient Temperature +70° C):

Use temperature-resistant cables with the following properties:

For the modules 0980 ESL1x9-1xx heat-resistant up to at least 85° C.

For the modules 0980 ESL1x9-33x heat-resistant up to at least 104° C.

For the modules 0980 ESL3x9-xxx heat-resistant up to at least 96° C.

For the modules 0980 ESL3x8-xxx heat-resistant up to at least 101° C.

## 5.3 Port assignments

All the contact arrangements shown in this chapter show the frontal view of the connection area for the connectors.

### 5.3.1 PROFINET ports, M12 socket, 4-pin, D-coded

Color coding: green

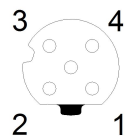

Figure 1: Schematic drawing, ports X01, X02

Port	Pin	Signal	Function
PROFINET Ports X01, X02	1	TD+	Transmit data plus
	2	RD+	Receive data plus
	3	TD-	Transmit data minus
	4	RD-	Receive data minus

Table 3: Assignment of ports X01, X02



**Caution: Risk of destruction!** Never connect the power supply to the data cables.

### 5.3.2 Power supply with M12 power L-coded

Color coding: gray

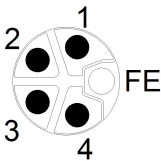

Figure 2: Schematic diagram of the M12 L-coding (connector)

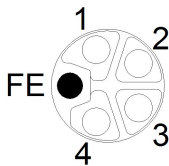

Figure 3: Schematic diagram of the M12 L-coding (socket)

Power supply	Pin	Signal	Function
	1	$U_S$ (+24 V)	Sensor/system power supply
	2	GND_ $U_{Aux}$	Ground/reference potential $U_{Aux}$
	3	GND_ $U_S$	Ground/reference potential $U_S$
	4	$U_{Aux}$ (+24 V)	Auxiliary supply (electrically isolated to $U_S$ )
	5	FE (PE)	Functional ground

Table 4: Power supply with M12-Power

**i** **Attention:** Only use power supply units for the system/sensor and actuator supply that correspond to PELV (Protective Extra Low Voltage) or SELV (Safety Extra Low Voltage). Power supplies according to EN 61558-2-6 (transformers) or EN 60950-1 (switching power supply units) fulfill these requirements.

### 5.3.3 PROFINET and power supply with M12 Hybrid

Color coding: gray

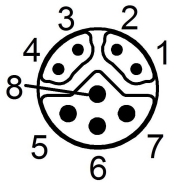

Figure 4: Schematic diagram of the M12 Hybrid (connector)

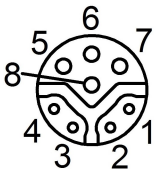

Figure 5: Schematic diagram of the M12 Hybrid (socket)

Ether + Power Supply	Pin	Signal	Function
PROFINET Ports X01, X02	1	TD+	Transmit data plus
	2	RD+	Receive data plus
	3	TD-	Transmit data minus
	4	RD-	Receive data minus
	5	GND_U <sub>S</sub>	Ground/reference potential GND_U <sub>S</sub>
	6	GND_U <sub>Aux</sub>	Ground/reference potential GND_U <sub>Aux</sub>
	7	U <sub>S</sub> (+24 V)	Sensor/system power supply
	8	U <sub>Aux</sub> (+24 V)	Auxiliary supply (electrically isolated)

Table 5: PROFINET and power supply with M12 Hybrid



**Attention:** Only use power supply units for the system/sensor and actuator supply that correspond to PELV (Protective Extra Low Voltage) or SELV (Safety Extra Low Voltage). Power supplies according to EN 61558-2-6 (transformers) or EN 60950-1 (switching power supply units) fulfill these requirements.

### 5.3.4 IO ports as M8 or M12 sockets

#### 5.3.4.1 IO-Link Type A

Color coding: black

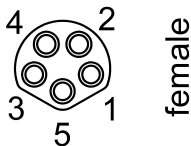

Figure 6: Schematic drawing IO port as M8 socket IO-Link Type A

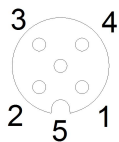

Figure 7: Schematic drawing IO port as M12 socket IO-Link Type A

IO-Link Type A	Pin	Signal	Function
	1	L+	IO-Link sensor power supply +24 V
	2	IN-x	Ch. B: Digital input (type 1)
	3	L-	IO-Link sensor supply GND_U <sub>S</sub>
	4	C/Q	Ch. A: IO-Link data communication
	5	NC	not connected

Table 6: IO ports as M8 or M12 socket IO-Link Type A

### 5.3.4.2 IO-Link Type B

Color coding: black

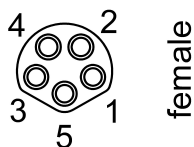

Figure 8: Schematic drawing IO port as M8 socket IO-Link Type B

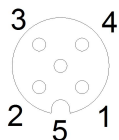

Figure 9: Schematic drawing IO port as M12 socket IO-Link Type B



IO-Link Type B	Pin	Signal	Function
	1	L+	IO-Link sensor power supply +24 V
	2	2L+ (U <sub>Aux</sub> )	Ch. B: Auxiliary power supply (electrically isolated with respect to the sensor/system power supply)
	3	L-	IO-Link sensor supply GND_U <sub>S</sub>
	4	C/Q	Ch. A: IO-Link data communication
	5	2M (GND_U <sub>Aux</sub> )	Ground/reference potential U <sub>Aux</sub>

Table 7: IO ports as M8 or M12 socket IO-Link Type B



**Warning:** IO Port – Sensor supply:

The sensor supply may only be carried out via the specified power connection (Power X03 --> US +24 V/GND\_U<sub>S</sub>) of the module. An external power supply over the IO port (Port X1-X8 --> Pin1/Pin3) is not permitted and can lead to a destruction of the module electronics!



**Warning:** IO Port connection (IO-Link - Class B):

The sensor supply (Port X5-X8 --> Pin1/Pin3) and the extended sensor supply (Port X5-X8 --> Pin2/Pin5) are galvanic isolated from each other. If the reference potentials (GND\_U<sub>S</sub> - Pin3) and (GND\_U<sub>Aux</sub> - Pin5) are connected, unacceptable compensation currents can flow. In this case the connection of a sensor at (Port X5-X8 --> Pin2) is not allowed!

The removal of the galvanic separation is not recommended.

## 6 Starting operation

### 6.1 GSDML file

A GSD file in XML format is required to configure the LioN-P modules. All module variants are grouped in a single GSDML file. This can be downloaded from our homepage

[www.beldensolutions.com/en/Service/download\\_center/index.phtml](http://www.beldensolutions.com/en/Service/download_center/index.phtml).

On request, the GSDML file is also sent by the support team.

The GSDML file and the associated bitmap files are grouped in the archive file named **GSDML-V2.3x-LumbergAutomation-LioN-P-yyyymmdd.xml**.

**yyyymmdd** stands for the date on which the file was issued.

Download this file and unpack it.

In **Step7** you create a new project and open the hardware manager "HWConfig". The GSD file is installed using the menu command **Options > Install station description files (GSDML) ...** and the subsequent dialog.

The LioN-P/-R IO modules with PROFINET interface are then available in the hardware catalog.

The GSDML file contains all PROFINET device variants for the LioN-P family of devices, including devices not described in this manual.

### 6.2 MAC addresses

Every module has three unique MAC address assigned by the manufacturer that cannot be changed by the user. The first assigned MAC address is printed of the module.

## 6.3 State on delivery

PROFINET parameters in state on delivery or after a factory reset:

PROFINET name:	Name not assigned
IP address:	0.0.0.0
Subnet mask:	0.0.0.0
Device designations:	0980 ESL 109-121 0980 ESL 109-122 0980 ESL 109-331 0980 ESL 109-332 0980 ESL 308-121 0980 ESL 309-121 0980 ESL 309-121-EEC 0980 ESL 199-121 0980 ESL 199-122 0980 ESL 199-331 0980 ESL 199-332 0980 ESL 398-121 0980 ESL 399-121 0980 ESL 399-121-EEC
Vendor ID:	0x016a
Device ID:	0x0305

## 6.4 Configuration of the LioN-P PROFINET IO modules in STEP 7

After installing the GSDML files for the LioN-P PROFINET modules, they are available in the hardware catalog on **PROFINET IO > Other field devices > IO > Lumberg LioN-P**.

First, configure the control system in the usual way. Assign an IP address and subnet mask for the PROFINET port of the control unit.

Then click on the article designations of the modules in the hardware catalog and move the desired module to the PROFINET line of the control unit.

### 6.4.1 Assigning a unique device name

PROFINET IO devices are addressed on PROFINET via a unique device name. This can be freely assigned by the user, but may only be used once on the network.

1. Select the module in **HW-Config** and open the menu **Edit > Object properties**. In the dialog box that opens, you can then change the device name.
2. Check whether the IP address displayed is correct, and the control unit and module are on the same Ethernet subsystem.
3. Confirm the entries by pressing "OK".

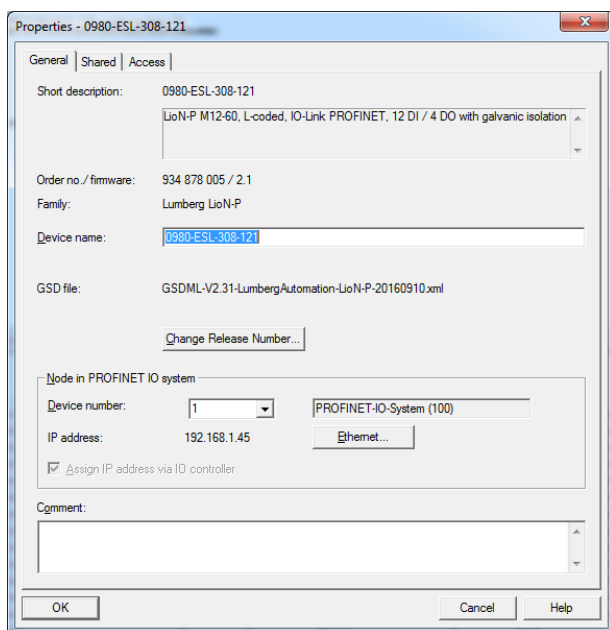

### 6.4.2 Assigning a device name to a LioN-P module

An online PROFINET connection between the programming device and the module is required to assign the device name to a module.

Select the LioN-P module and open the **Target device > Ethernet > assign name** dialog.

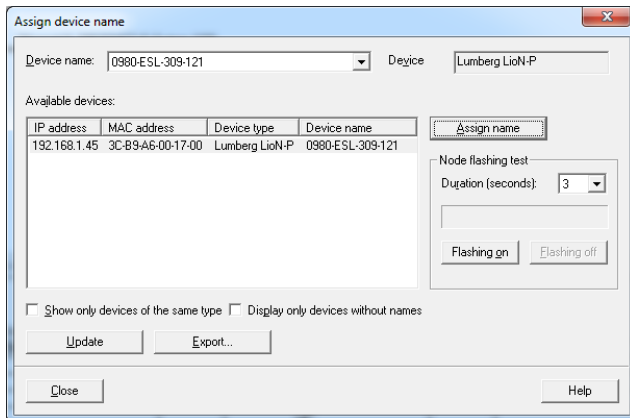

### 6.4.3 Configuring the IO-Link channels

A pre-configuration of the IO function is automatically used for slot 1 of the subrack. By default, all channels are pre-configured as digital inputs as per the IO-Link specification.

The configurations of the IO-Link channels (C/Q or Ch. A/Pin 4 of the IO-port) in the sub-slots 2 - 9 (port 1 of the device is equivalent to subslot 2, ..., port 8 of the device is equivalent to sub-slot 9) are flexibly definable.

The input and output addresses defined by the Hardware Manager can be changed.

The following illustration shows the device pre-configuration using the 0980 ESL 109-121 module as an example:

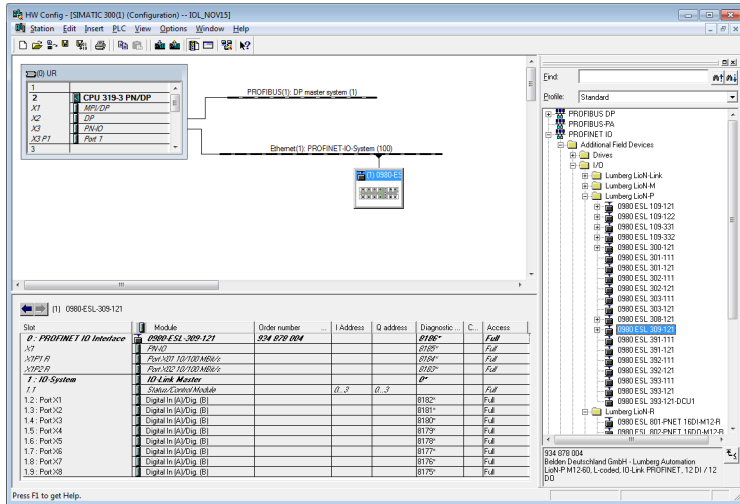

### 6.4.3.1 Deleting the configuration of an IO-Link channel

1. To delete an IO-Link channel, select the desired IO-Link channel in **HW Config**.
2. Right click and then select the **Clear** option in the menu that appears.
3. Select the channel you want to delete:

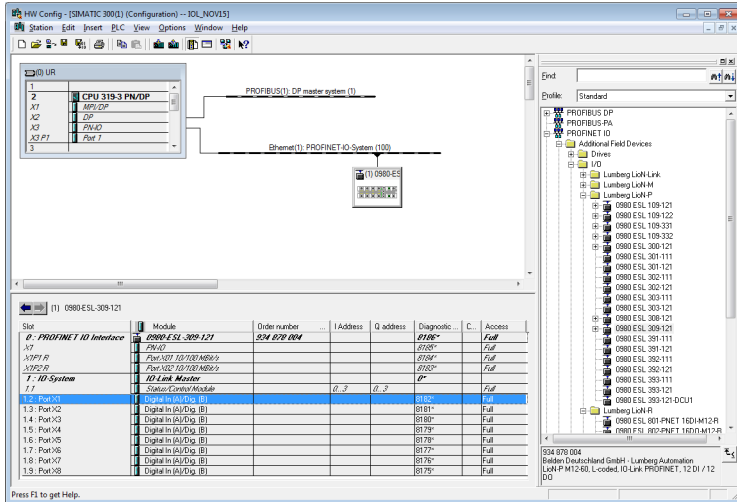

Figure 10: Free IO-Link channel

4. Right click this entry. The following menu appears:

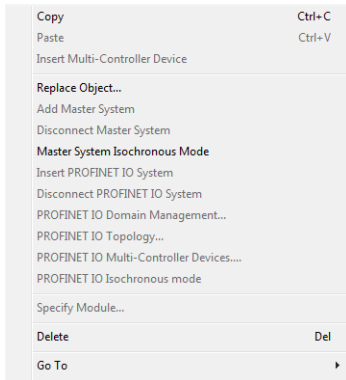

Figure 11: Menu dialog

5. Select the **Clear** option. Press **Yes** to confirm the dialog that follows.

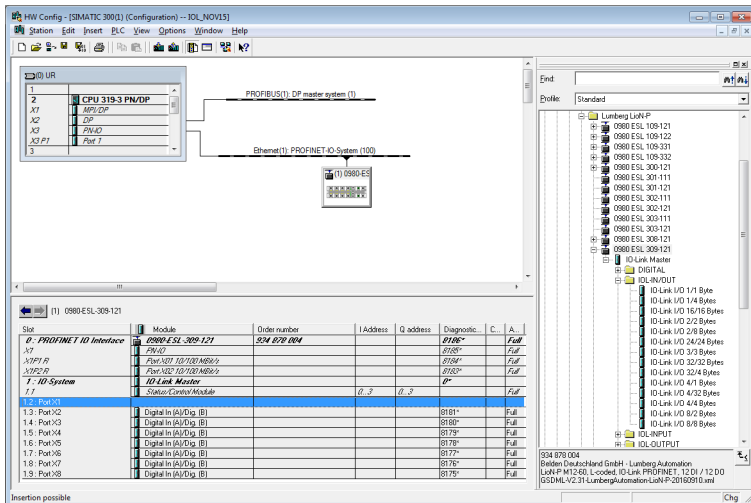

Figure 12: Free IO-Link channel

### 6.4.3.2 Configuring an IO-Link channel configuration

Click 3x on the + symbols in the hardware catalog of the device you want to configure to reveal a selection of options:

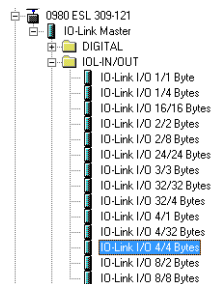

Figure 13: IO-Link channel configuration

Select the desired option, click and hold down the left mouse button to drag the configuration to a free IO-Link sub-slot.

The following options are available for the IO-Link C/Q channel (ch. A/pin 4):

#### Digital Input



In this mode the channel operates as a digital input. The IO-Link master does not try to establish communication to a connected IO-Link device.

### SIO mode (DI)

This mode is used to parameterize the IO-Link devices. It relies on the fallback mechanism from COM mode to SIO mode.

In this mode the IO-Link device can be parametrized during the module's startup time and changes to digital input mode via the fallback mechanism.

Additionally, the cyclical output bits in the COM control byte (chapter 8.5.5) of the IO-Link master can be used at any time to set the appropriate channels in COM mode and thus enable the IO-Link device for parametrization.



**Attention:** Please note that the status of the digital input signal is not updated during optional COM operations.

### Digital Output

In this mode, the channel operates as a digital output. It is impossible at any time to communicate with the connected device. The "Digital Output" option for IO-Link C/Q channel (ch. A/pin4) is not available for the 0980 ESL 3x8-121 device.

### Inactive

This mode should be selected if the channel is not used. The L+ power supply (pin 1) of the port is disabled in this case.

### IO-Link ...

In this mode (COM mode), the process data from or to the device are exchanged over a communication link. The IO-Link Master automatically starts communicating with the connected IO-link device, taking into account the baud rate. Additionally, this mode offers the option of parameterizing the IO-Link device. Configuration

modules with data lengths of 1-32 input and/or output bytes are available. If no suitable configuration module is available for the device, the next larger data length must be selected.

### 6.4.4 Parameterization of the IO-Link channels

Double-clicking on the corresponding IO-Link sub-slot in the hardware configuration and selecting the "Parameter" tab, lets you set the following parameters:

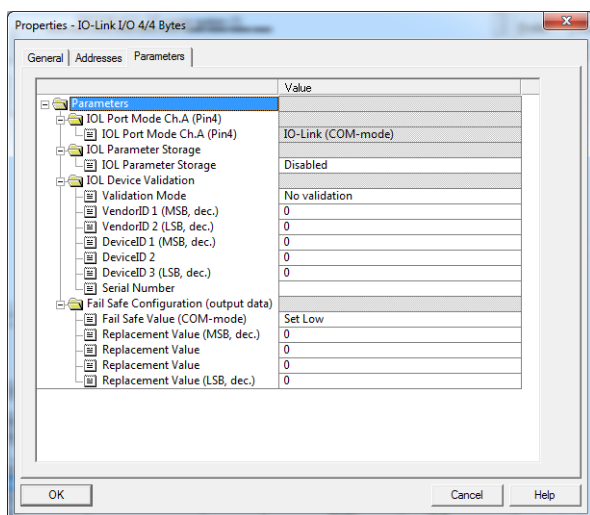

Figure 14: Parameter of the IO-Link channels

#### 6.4.4.1 IOL Parameter storage

The Parameter Server of the IO-Link Master can be parameterized in the **Parameter storage** tab. The **Parameter storage** function manages the IO-Link device parameters to enable a simple device or Master replacement.

The following options can be set:

#### Disabled

Disabled mode is the default setting in as-delivered condition. The data maintenance function is disabled.

If parameter data of a device were stored previously, these data remain stored without any changes.

### **Download only (master to device)**

Enables the parameter data download function to the IO-Link device on the master.

Parameter data can only be uploaded to an IO-Link device if they exist on the parameter server and are usable for the device. When an IO-Link device is connected, the master compares the stored parameter data with the device data. If the function is not locked on the device ("Parameter storage" locked), the master downloads the stored data to the device in case of differences.

IO-Link device data can be loaded using the "Upload only" mode. If the master does not have a device parameter set stored, the mode must be compared with "Disabled".

Replacement of the IO-Link device is possible in this mode.

### **Upload only (device to master)**

Enables the parameter data upload function to the IO-Link master from the device.

An upload is performed when an IO-Link device is connected and the master does not have any valid data. This is the case if "Disabled and Cleared" mode was configured previously and/or in case of "Disabled" in as-delivered condition.

If parameter data are changed on the device during runtime, the device data stored on the master can be overwritten using the ParamDownloadStore (Index 0x0002, Subindex 0x00, Value 0x05 command. This command sets the DS\_UPLOAD\_REQ flag on the device, and thus executes an upload.

The IO-Link master can be replaced in this mode.

### **Download and Upload**

Enables the IO-Link parameter data download and upload function.

An upload is performed when an IO-Link device is connected and the master does not have any valid data. This is the case if "Disabled and Cleared" mode was configured previously and/or in case of "Disabled" in as-delivered condition. The parameter data read are permanently stored on the master.

If parameter data are changed on the device during runtime, the device data stored on the master can be overwritten using the ParamDownloadStore (Index 0x0002, Subindex 0x00, Value 0x05) command. This command sets the DS\_UPLOAD\_REQ flag on the device, and thus executes an upload.

For each new connection to an IO-Link device, the master compares the stored parameter data with the device data. If the function is not locked on the device ("Parameter storage" locked), the master downloads the stored data to the device in case of differences.

The IO-Link device can be replaced in this mode.

Action	IO-Link Master State	IO-Link Device State
Upload	Invalid Data (Cleared before)	Upload Flag active (Valid Data)
Upload	Invalid Data (Cleared before)	Upload Flag not active & Valid Data
Upload	Valid Data	Upload Flag active & Valid Data
Download	Valid Data	Upload Flag not active (Data Equal)

### Disabled and Cleared

The data retention function is disabled; and stored data are deleted.



**Attention:** An IO-Link device sets the "Upload Flag" self-dependent, if parameter were written in block mode to the IO-Link device.

### 6.4.4.2 IOL Device Validation

The IOL Device Validation (IO-Link Device Identification) lets you check the connected devices for the values set in the control program in order to, e.g., identify correctly connected devices and not start operations with them.

#### Validation mode

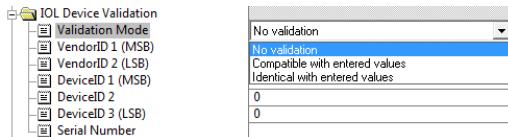

Figure 15: IO-Link Device Identification

#### No validation

This option is the default setting. In this case, neither the VendorID, DeviceID, nor the serial number are synchronized after powering on between the IO-Link device and the entered IO-Link Master data before communication starts.

#### Compatible with entered values

With this option, the VendorID and DeviceID are synchronized after powering on between the IO-Link device and the entered IO-Link Master data before communication starts. Process data communication is only established if the configured values match the values reported by the device.

Replacement of the an IO-Link device of the same type is thus possible without changes in the Engineering Tool.

#### Identical with entered values

In this case, the VendorID, DeviceID and serial number are synchronized after powering on between the IO-Link device and the entered IO-Link Master data before communication starts. Process data communication is only established if the configured values match the values reported by the device.

Replacement of the an IO-Link device of the same type is thus only possible if the serial number is changed in the Engineering Tool at the same time.

### VendorID

The VendorID of the IO-link device used can be entered as a decimal value in the **VendorID 1** (high-order byte) and **VendorID 2** (loworder byte) fields.

### DeviceID

The DeviceID of the IO-link device used can be entered as a decimal value in the **DeviceID 1** (high-order byte) and **DeviceID 3** (low-order byte) fields.

### Serial Number

The serial number of the IO-link device can be entered as a string in the **Serial Number** input field. The input is limited to 16 characters.

#### 6.4.4.3 Fail Safe Configuration (for outputs only)

This option is only applicable for IO-Link channels in COM mode where output data are used. In COM mode, the IO data are exchanged between the IO-Link master and IO-Link device via serial communication.

#### Fail Safe Value (COM-Mode)

The following values are selectable:

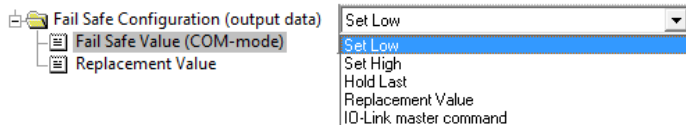

Figure 16: Fail Safe Configuration

#### Set Low

All bits of the output data with a value of **0** are transmitted to the IO-Link device. (Default setting)

#### Set High

All bits of the output data with a value of **1** are transmitted to the IO-Link device.

### Hold Last

The last valid output value received by the control unit is continuously and cyclically transmitted to the IO-Link device.

### Replacement Value

If this option is selected, the value entered in the **Replacement Value** input field described below is continuously and cyclically transmitted to the IO-Link device.

### IO-Link master command

The **IO-Link-Master-Command** option allows the use of IO-linkspecific mechanisms for valid/invalid output process data. Thus, the device itself determines the behavior.

### Replacement Value

Fail Safe Configuration (output data)	
Fail Safe Value (COM-mode)	Replacement Value
Replacement Value MSB	0
Replacement Value	0
Replacement Value	0
Replacement Value LSB	0

Figure 17: Replacement Value

If "Fail Safe Value" the option "Replacement Value" was set below the parameter option, then the substitute value entered in this input field/these input fields is used. The value must be entered as a decimal value. Depending on the configured data length, the values must be entered as bytes (0-255) or word decimal values (0-65535) in the order shown.

- ▶ MSB = high order byte
- ▶ LSB = low order byte
- ▶ MSW = high order word
- ▶ LSW = low order word

## 6.4.5 Parameterization of the status/control module

Slot	Module	Order number ...	I Address	Q address	Diagnostic ...	C...	Access
0 : PROFINET IO Interface	0980-ESL-309-121	934 878 004			8186*		Full
X1	PN-IO				8185*		Full
X1P1 R	Port-X01 IO/100 MBit/s				8184*		Full
X1P2 R	Port-X02 IO/100 MBit/s				8183*		Full
1 : IO-System	IO-Link Master				0*		
1.1	Status/Control Module		0...3	0...3			Full

Figure 18: Status/Control module

The status/control module in slot 1/sub-slot 1 is pre-configured for each LioNP IO-LinkMaster. It consists of 4 bytes of input and 4 bytes of output data for the digital IO/ data, and status and control bits of the IO-Link Master. The bit assignments are described in Section [Bit assignment](#) on page 70.

The Status/Control module can also be used to perform all parameterizations that do not affect ports in IO-Link COM mode.

The following parameterizations are possible after double clicking **Status/Control Module** in the **Parameter** tab:

### 6.4.5.1 General Device Settings

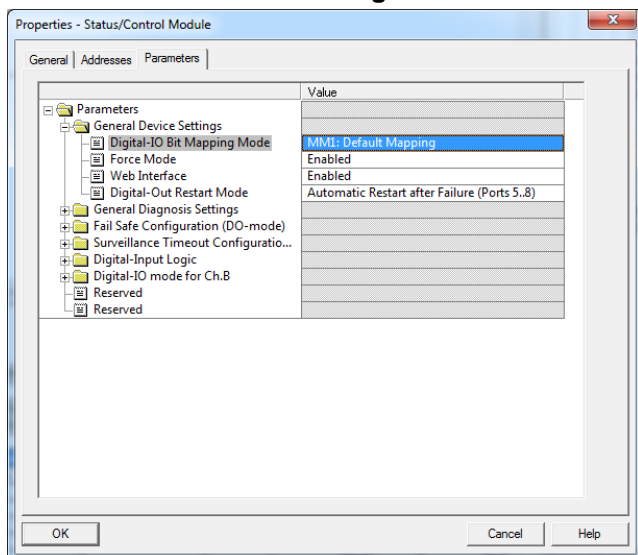

Figure 19: General device settings



The **Digital-IO Bit Mapping Mode** parameter can be used to define the mappings of the input/output bits that are transmitted in the cyclical data of the **Status/Control** Module from the control unit to the devices, or from the device to the control unit.

### MM1 (Default Mapping)

In Mapping Mode 1 (MM1), the first channel bit (C/Q, Ch. A / Pin 4) and the second channel bit (Ch. B / Pin2) are transmitted alternately in ascending order for all ports.

### MM2 (E2C Compatible Mapping)

In Mapping Mode 2 (MM2), the first channel bits (C/Q, Ch. A / Pin 4) and the second channel bits (Ch. B / Pin2) are transmitted consecutively in ascending order for all ports.

The different formats are also shown in Section [Bit assignment](#) on page 70.

#### 6.4.5.2 General Diagnosis Settings

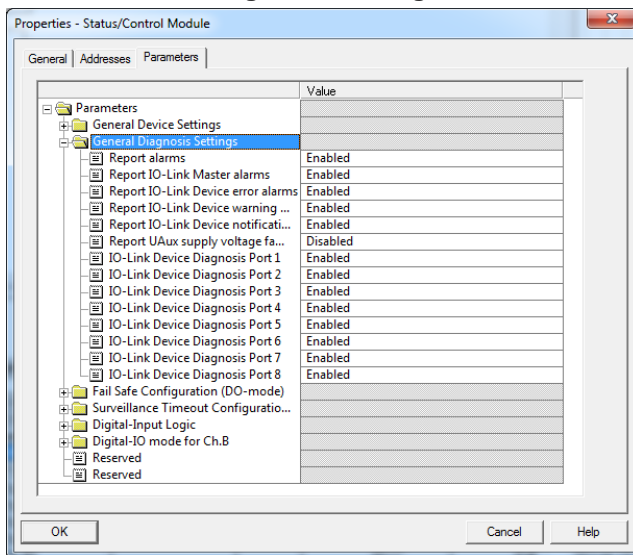

Figure 20: General diagnosis settings

Diagnostics or diagnostics levels can be enabled or disabled in the General Diagnosis Settings folder.

The figure shows the default setting.



**Attention:** "Report  $U_{AUX}$  supply voltage fault" is disabled in the default setting, to avoid diagnostic messages due to switching the supply voltage on or off later on.

### 6.4.5.3 Fail Safe Value (DO-Mode)

The device supports a failsafe function for the channels used as digital outputs. During configuration of the devices, the status of the outputs can be defined after an interruption, or loss of communication on the PROFINET IO network.

The following options can be selected:

- ▶ Set Low - the output channel is disabled and/or the output bit set to **0**.
- ▶ Set High - the output channel is enabled and/or the output bit set to **1**.
- ▶ Hold last – the last output state is kept.

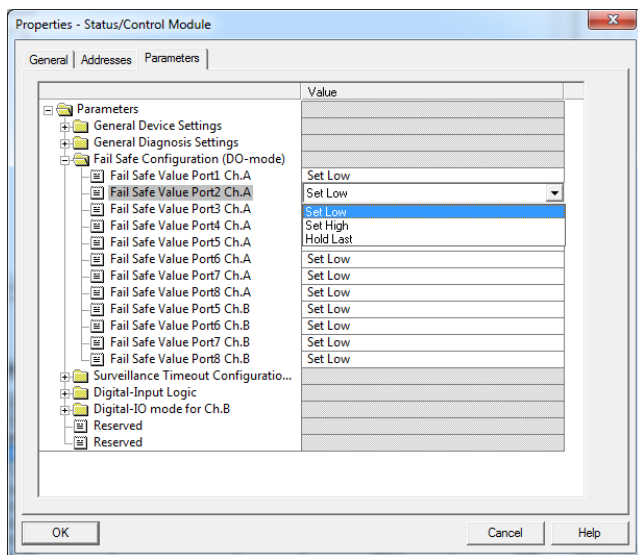

Figure 21: Fail safe value

### 6.4.6 Surveillance Timeout Configuration (LioN-P 60 devices)

For LioN-P 60 devices, the separate power supply 2L+ (UAux), which is available on type B IO-Link channels (Ch.B / Pin2), ports 5-8, can also be configured as an additional digital output (tab: "Digital-IO mode for Ch. B (Pin2)"). This gives you the option of switching the power supply like a digital output.

The firmware of the modules allows you to configure a delay time before output current monitoring is enabled for this special use case.

The delay time is referred to as the "Surveillance-Timeout" and can be configured for each output channel. The delay time begins after the state of the output channel changes, i.e., when it is activated (after a rising edge) or deactivated (after a falling edge). After this time has elapsed, the output is monitored, and error states are reported by diagnostics.

The "Surveillance-Timeout" parameter can be set from 0 to 255 ms. The default value for this parameter is 80 ms. When an output channel is in static state, i.e., when the channel is permanently switched on or off, the typical value is 5 ms.

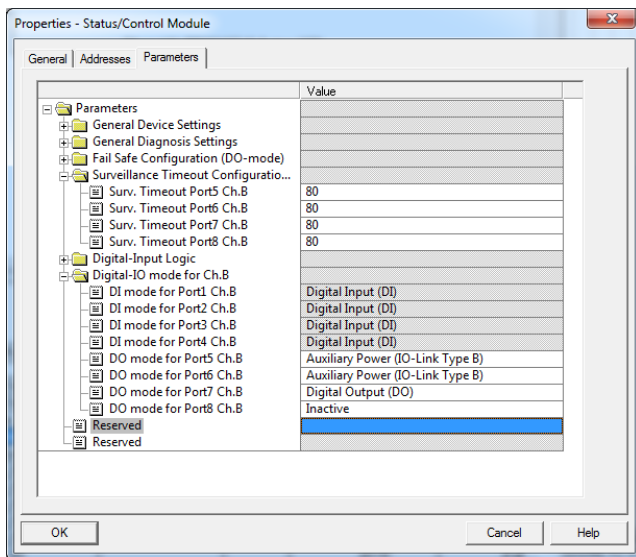

Figure 22: Surveillance Timeout Configuration

### 6.4.7 Digital input logic

This parameter can be used to configure the logic of channels used as digital inputs.

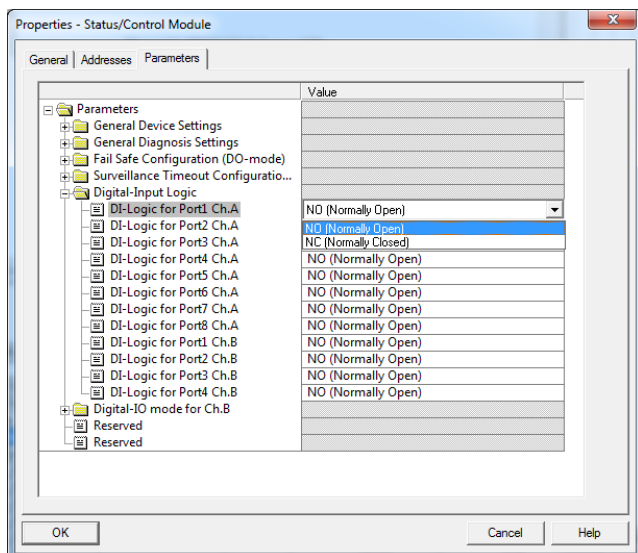

Figure 23: Digital input logic

#### Default setting

NO (Normally Open) for all channels

#### NO (Normally Open)

A non-damped sensor has an open switching output (low signal) in this case. The device input detects a low signal and returns a 0 to the control unit.

#### NC (Normally Closed)

A non-damped sensor has a closed switching output (high signal) in this case. The device input detects a high signal, inverts the signal, and returns a 0 to the control unit.

## 6.4.8 Digital-IO mode for Ch. B/Pin 2

### 6.4.8.1 Digital-IO mode for Ch. B/Pin 2 (LioN-P 30 devices)

The type B IO-Link ports of the LioN-P 30 devices have a fixed configuration. The functionality is shown in the following figure:

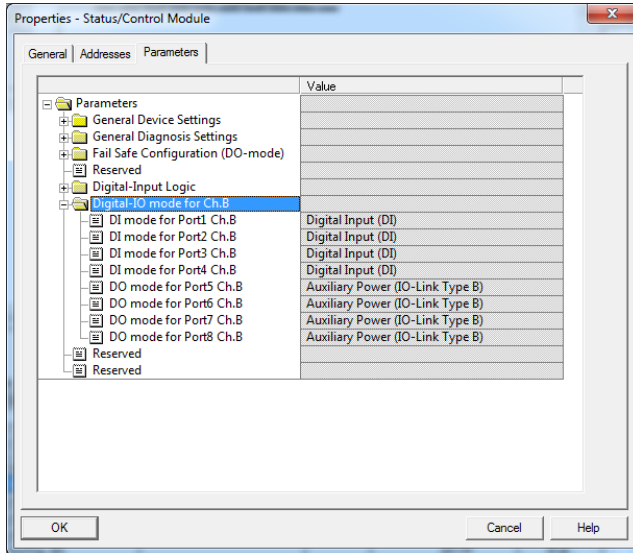

Figure 24: Digital IO mode (LioN-P 30 devices)

### 6.4.8.2 Digital-IO mode for Ch. B/Pin 2 (LioN-P 60 devices)

The type B IO-Link ports, ports 5- 8 on the LioN-P 60 devices, can be parameterized as follows:

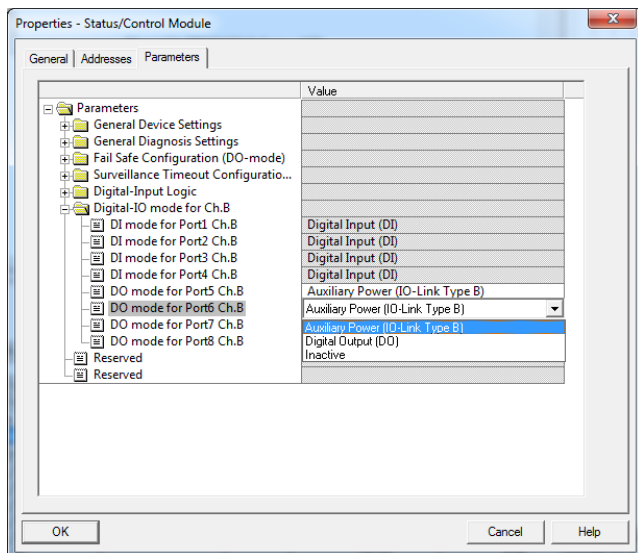

Figure 25: Digital IO mode (LioN-P 60 devices)

## Default setting

Auxiliary Power Supply (IO-Link Type B)

### Auxiliary Power (IO-Link Type B)

In this mode, Pin 2 and Pin 5 of the type B IO-Link ports, ports 5 - 8, act as an auxiliary voltage output. The auxiliary voltage is fed from the  $U_{Aux}$  supply input. The auxiliary voltage output cannot be controlled.

### Digital Output (DO)

In this mode, Ch. B/Pin 2 of the type B IO-Link ports, ports 5 - 8, can be used as a digital output. The control bits are transferred by the control unit to the device within the status/control module. A **Surveillance-Timeout** can be parameterized for the outputs (tab **Surveillance Timeout Configuration**).

## 6.5 IO-Link Device Parameterization

### 6.5.1 SIEMENS IO-Link library

The SIEMENS **STEP 7** "IO\_LINK\_CALL" function module can both acyclically write device parameters of an IO-link device and read parameters, measured values and diagnostic data. In a revised version of this library, "IO\_LINK\_CALL" has been replaced by the "IO\_LINK\_DEVICE" module for acyclic communication with IO-link devices.

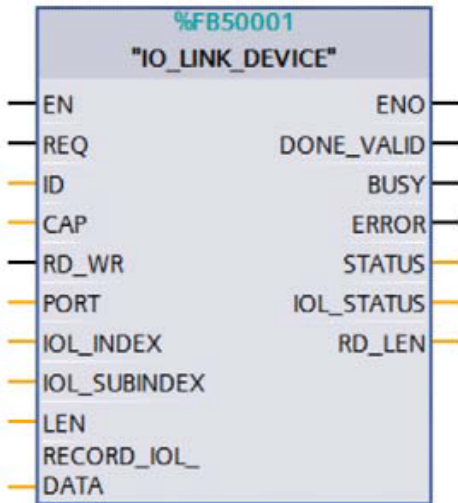

Figure 26: STEP 7 V13 SP1

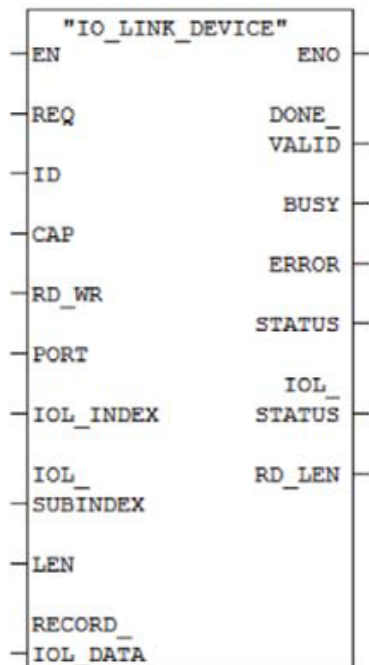

Figure 27: STEP 7 V5.5

Service data are uniquely addressed via the index and the sub-index and can be accessed or written via the logical start address of the status/control module (ID) inputs, the client access point (CAP = 255) and the corresponding IO-link port (PORT). 1 - 8 for IO-Link Ports).

**i Attention:** If the logical input address for the IO\_LINK\_CALL module is used, it may be necessary for the input address to be the lesser than or equal to the output address. It may be necessary to modify this value manually in the Engineering Tool.



Operand	Symbol	Anzeigeformat	Statuswert	Steuerwert	
1	#IO_LINK_CALL Input Parameters				
2	DB1 DBX 0.0	"IO_LINK_CALL_DATA" REQ	BOOL	false	true
3	DB1 DBD 2	"IO_LINK_CALL_DATA" ID	DEZ	L#0	L#0
4	DB1 DBW 6	"IO_LINK_CALL_DATA" CAP	DEZ	255	255
5	DB1 DBX 8.0	"IO_LINK_CALL_DATA" RD_WAR	BOOL	false	false
6	DB1 DBW 10	"IO_LINK_CALL_DATA" PORT	DEZ	4	4
7	DB1 DBW 12	"IO_LINK_CALL_DATA" IOL_INDEX	DEZ	24	24
8	DB1 DBW 14	"IO_LINK_CALL_DATA" IOL_SUBINDEX	DEZ	0	0
9	DB1 DBW 16	"IO_LINK_CALL_DATA" LEN	DEZ	0	0
10					
11	#IO_LINK_CALL Output Parameters				
12	DB1 DBX 28.0	"IO_LINK_CALL_DATA" DONE_VALID	BOOL	false	
13	DB1 DBX 28.1	"IO_LINK_CALL_DATA" BUSY	BOOL	false	
14	DB1 DBX 28.2	"IO_LINK_CALL_DATA" ERROR	BOOL	false	
15	DB1 DBD 30	"IO_LINK_CALL_DATA" STATUS	HEX	DW#16#00000000	
16	DB1 DBD 34	"IO_LINK_CALL_DATA" IOL_STATUS	HEX	DW#16#00010000	
17	DB1 DBW 38	"IO_LINK_CALL_DATA" RD_LEN	HEX	VW#16#0000	
18					
19	#IO_LINK_CALL Device Data				
20	MB 100		ZEICHEN	'B'	
21	MB 101		ZEICHEN	'E'	
22	MB 102		ZEICHEN	'L'	
23	MB 103		ZEICHEN	'D'	
24	MB 104		ZEICHEN	'E'	
25	MB 105		ZEICHEN	'F'	
26	MB 106		ZEICHEN	''	
27	MB 107		HEX	L#16#20	

## 6.6 SNMP

The PROFINET IO-Link master supports SNMP objects required by the PROFINET specification as per protocol standard SNMP v1. These include objects from RFC 1213 MIB-II (System Group and Interfaces Group) and the LLDP MIB.

Passwords:

- ▶ Read Community: public
- ▶ Write Community: private

## 6.7 Media Redundancy Protocol (MRP)

Redundant PROFINET communication can be implemented with the LioN-P modules via a ring topology without the use of additional switches. A MRP redundancy manager terminates the ring, detects individual failures, and transmits the data packets on the redundant path in case of error.

The following conditions must be met to use MRP:

- ▶ All devices must support MRP.
- ▶ MRP must be enabled on all devices.
- ▶ Connections to the devices are only possible via the ring ports. A mesh topology is not permissible.
- ▶ A max. of 50 devices are permissible in the ring.
- ▶ All devices share the same redundancy domain.
- ▶ One device must be configured as the redundancy manager.
- ▶ All other devices must be configured as redundancy clients.
- ▶ Prioritized boot (FSU) is permissible.
- ▶ The response monitoring time of all devices must be greater than the reconfiguration time (typically 200 ms, min. 90 ms for LioN-P modules).
- ▶ It is recommended to use automatic network settings on all devices.

The following figures show a possible MRP ring configuration. The PLC is used as the redundancy manager while all other devices are clients. To detect an individual failure, it is advisable to use the diagnostics alerts.

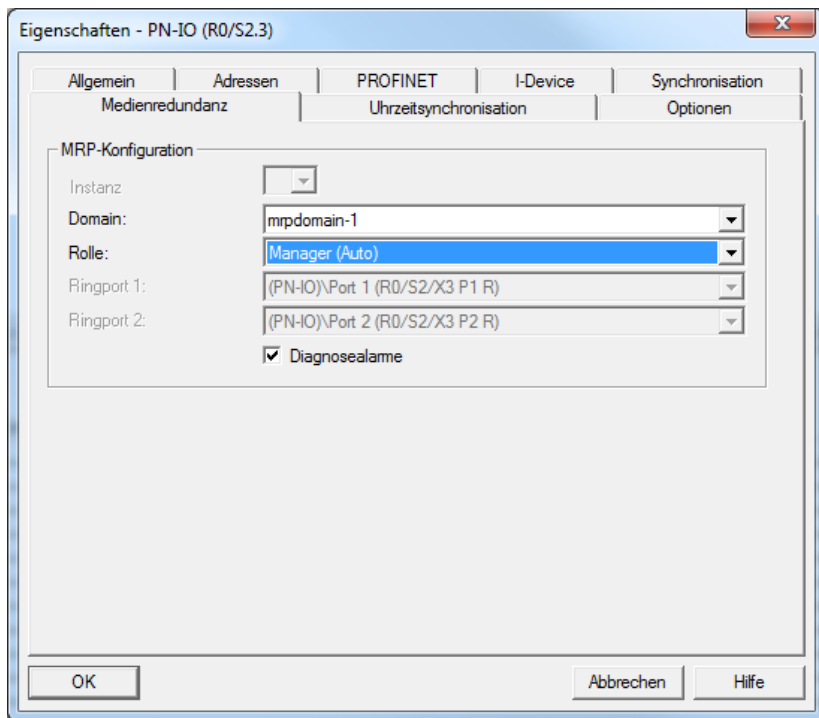

Figure 28: Example of setting up the MRP redundancy manager in STEP7

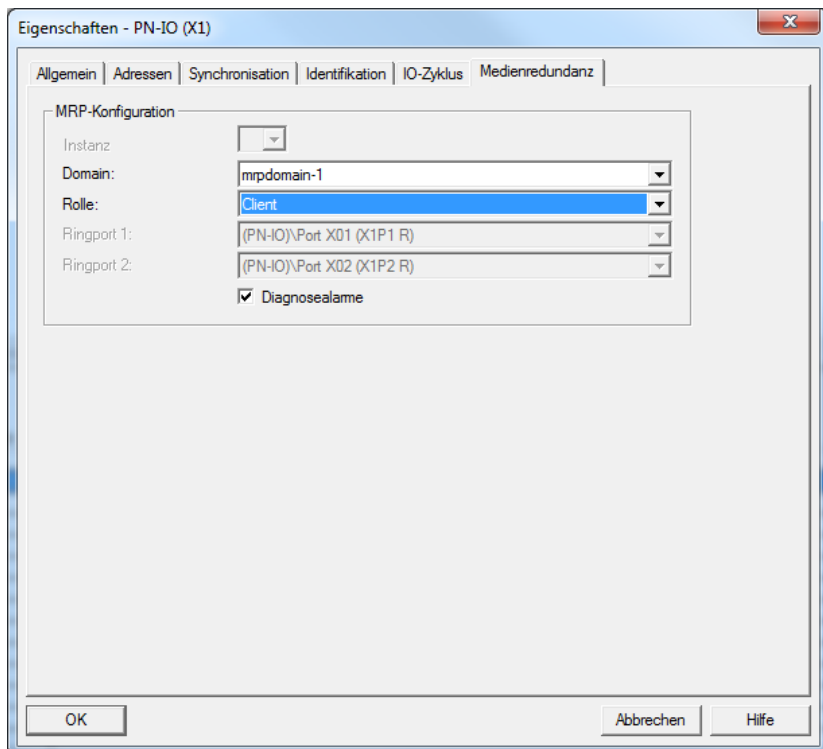

Figure 29: Example of setting up an MRP redundancy client in STEP7

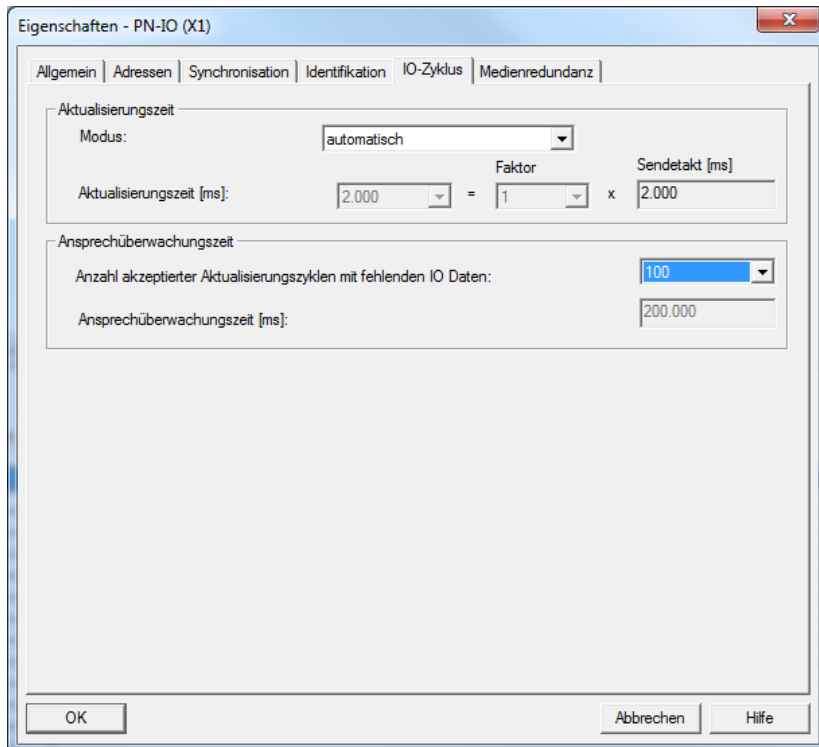

Figure 30: Example of setting up the response monitoring times in STEP7

## 6.8 Identification & maintenance functions (I&M)

The PROFINET module has the ability to uniquely identify the devices installed in the system via an electronic nameplate. This device-specific data can be read acyclically by the user at any time. Furthermore, the installation date, location code and further descriptions can be stored in the module when creating the system. The I&M functions provide this functionality.

## 6.8.1 Supported I&M features

### 6.8.1.1 Module-specific I&M features

The module-specific I&M features 0 through 4 can be read or written via slot 0. The specified index is used for mapping the data sets.

Data object	Length [byte]	Access	Default value / Description
MANUFACTURER_ID	2	Read	0x016A (Belden Deutschland GmbH)
ORDER_ID	20	Read	Order number of module in ASCII
SERIAL_NUMBER	16	Read	Defined in production process in ASCII
HARDWARE_REVISION	2	Read	Hardware revision of device
SOFTWARE_REVISION	4	Read	Software revision of device
REVISION_COUNTER	2	Read	Incremented for every statically stored parameter change on IO-Link master (e.g., device name or IP address)
PROFILE_ID	2	Read	0xF600 (Generic device)
PROFILE_SPECIFIC_TYPE	2	Read	0x0003 (IO modules)
IM_VERSION	2	Read	0x0101 (I&M Version 1.1)
IM_SUPPORTED	2	Read	0x001E (I&M 1 ... 4 is supported)

Table 8: I&M 0 (Slot 0, Index 0xAFF0)

Data object	Length [byte]	Access	Default value / Description
TAG_FUNCTION	32	Read/ Write	0x20 ff. (empty)
TAG_LOCATION	22	Read/ Write	0x20 ff. (empty)

Table 9: I&M 1 (Slot 0, Index 0xAFF1)

Data object	Length [byte]	Access	Default value / Description
INSTALLATION_DATE	16	Read/ Write	0x20 ff. (empty); Supported data format is a visible string with a fix length of 16 byte; "YYYY-MM-DD hh:mm" or "YYYY-MM-DD" filled with blank spaces

Table 10: I&M 2 (Slot 0, Index 0xAFF2)

Data object	Length [byte]	Access	Default value / Description
DESCRIPTOR	54	Read/ Write	0x20 ff. (empty)

Table 11: I&M 3 (Slot 0, Index 0xAFF3)

Data object	Length [byte]	Access	Default value / Description
SIGNATURE	54	Read/ Write	0x20 ff. (empty)

Table 12: I&M 4 (Slot 0, Index 0xAFF4)

### 6.8.1.2 IO-Link Master I&M functions

The IO-Link Master-specific I&M functions 0 and 99 can be read via slot 1. The specified index is used for mapping the data sets.

Data object	Length [byte]	Access	Default value / Description
MANUFACTURER_ID	2	Read	0x016A (Belden Deutschland GmbH)
ORDER_ID	20	Read	Order number of module in ASCII
SERIAL_NUMBER	16	Read	Defined in production process in ASCII
HARDWARE_REVISION	2	Read	Hardware revision of device
SOFTWARE_REVISION	4	Read	Software revision of device
REVISION_COUNTER	2	Read	Incremented for every statically stored parameter change on IOLink Master (e.g., device name or IP address)
PROFILE_ID	2	Read	0xF600 (Generic device)
PROFILE_SPECIFIC_TYPE	2	Read	0x0003 (IO modules)
IM_VERSION	2	Read	0x0101 (I&M Version 1.1)
IM_SUPPORTED	2	Read	0x001E (I&M 1 ... 4 is supported)

Table 13: I&amp;M 0 (Slot 1, Index 0xAFF0)

Data object	Length [byte]	Access	Default value / Description
IOL_VERSION	1	Read	0x11 (IO-Link Version 1.1)
IOL_PROFILE_VERSION	1	Read	0x10 (IO-Link Profile Version 1.0)
IOL_FEATURE_SUPPORT	4	Read	0x00000000
NUMBER_OF_PORTS	1	Read	0x08 (Number of supported IOLinkPorts)
REF_PORT_CONFIG	1	Read	0x00 (No port configuration data supported)
REF_IO_MAPPING	1	Read	0x00 (No IO mapping data supported)
REF_IPAR_DIRECTORY	1	Read	0x00 (No iPar directory supported)
REF_IOL_M	1	Read	0x00 (No IOL-M parameter supported)
NUMBER_OF_CAPS	1	Read	0x01 (Number of Client Access Points)



Data object	Length [byte]	Access	Default value / Description
NDEX_CAP1	1	Read	0xFF (Client Access Point for IOL_CALL)

Table 14: I&M 99 (Slot 1, Index 0xB063)

### 6.8.1.3 IO-Link Device I&M functions

The IO-Link device-specific I&M functions 16 and 23 can be read via slot 1, sub-slot 1. The specified index is used for mapping the data sets. Only data not equal to zero are received if a connection to an IO-Link device can be established.

Data object	Length [byte]	Access	Default value / Description
VENDOR_ID	2	Read	0x0000 (IO-Link Device Vendor ID)
DEVICE_ID	4	Read	0x00000000 (IO-Link Device ID)
FUNCTION_ID	2	Read	0x0000 (IO-Link Device Function ID)
RESERVED	10	Read	0x00 ff.

Table 15: I&M 16 ... 23 (Slot 1, Subslot 1, Index 0xB000...0xB007)

## 6.8.2 Reading and writing I&M data

In its standard library, SIEMENS offers **STEP 7** system function modules that allow I&M data to be read and written. A data set contains a 6-byte block header and the actual I&M record.

The data requested on reading, or the data to be written thus only start after the existing header. On writing, the header content must additionally be taken into account. Following table shows the structure of a data set.

Data object	Length [byte]	Data type	Coding	Description
BlockType	2	Word	I&M 0: 0x0020 I&M 1: 0x0021 I&M 2: 0x0022 I&M 3: 0x0023 I&M 4: 0x0024 I&M 16 ... 23: 0x0F00 I&M 99: 0x0F00	BlockHeader
BlockLength	2	Word	I&M 0: 0x0038 I&M 1: 0x0038 I&M 2: 0x0012 I&M 3: 0x0038 I&M 4: 0x0038 I&M 16 ... 23: 0x0014 I&M 99: 0x000F	
BlockVersionHigh	1	Byte	0x01	
BlockVersionLow	1	Byte	0x00	
I&M Data	I&M 0: 54 I&M 1: 54 I&M 2: 16 I&M 3: 54 I&M 4: 54 I&M 16 ... 23: 18 I&M 99: 13	Byte		I&M Record

Table 16: Data set with BlockHeader and I&M Record

### 6.8.2.1 I&M Read Record

I&M data can be read via the standard RDREC (SFB52) function block in **STEP 7**. The logical address of the slot/sub-slot (ID) and the I&M index (INDEX) must be used as handover parameters. The return parameters show the length of the I&M data received, and contain a status or error message.

Operand	Symbol	Anzeigeformat	Statuswert	Steuwert
<b>// FB inputs</b>				
DB152.DBX 0.0	"PNO_IM_RD_DB" REQ	BOOL	false	true
DB152.DBD 2	"PNO_IM_RD_DB" ID	DEZ	L#8185	L#8185
DB152.DBW 6	"PNO_IM_RD_DB" IM_INDEX	HEX	W#16#AFF0	W#16#AFF0
<b>// FB outputs</b>				
DB152.DBX 8.0	"PNO_IM_RD_DB" VALID	BOOL	true	
DB152.DBX 8.1	"PNO_IM_RD_DB" BUSY	BOOL	false	
DB152.DBX 8.2	"PNO_IM_RD_DB" ERROR	BOOL	false	
DB152.DBD 10	"PNO_IM_RD_DB" STATUS	HEX	DW#16#00000000	
DB152.DBW 14	"PNO_IM_RD_DB" LEN	DEZ	54	
<b>// Data header</b>				
DB52.DBB 0	"PNO_IM_RD_DATA" IM_DATA[1]	HEX	B#16#00	
DB52.DBB 1	"PNO_IM_RD_DATA" IM_DATA[2]	HEX	B#16#20	
DB52.DBB 2	"PNO_IM_RD_DATA" IM_DATA[3]	HEX	B#16#00	
DB52.DBB 3	"PNO_IM_RD_DATA" IM_DATA[4]	HEX	B#16#38	
DB52.DBB 4	"PNO_IM_RD_DATA" IM_DATA[5]	HEX	B#16#01	
DB52.DBB 5	"PNO_IM_RD_DATA" IM_DATA[6]	HEX	B#16#00	
<b>// Data record</b>				
DB52.DBB 8	"PNO_IM_RD_DATA" IM_DATA[7]	HEX	B#16#01	
DB52.DBB 7	"PNO_IM_RD_DATA" IM_DATA[8]	HEX	B#16#8A	
DB52.DBB 8	"PNO_IM_RD_DATA" IM_DATA[9]	HEX	B#16#39	
DB52.DBB 9	"PNO_IM_RD_DATA" IM_DATA[10]	HEX	D#10#33	
DB52.DBB 10	"PNO_IM_RD_DATA" IM_DATA[11]	HEX	D#10#34	
DB52.DBB 11	"PNO_IM_RD_DATA" IM_DATA[12]	HEX	D#10#20	
DB52.DBB 12	"PNO_IM_RD_DATA" IM_DATA[13]	HEX	D#10#38	
DB52.DBB 13	"PNO_IM_RD_DATA" IM_DATA[14]	HEX	D#10#37	
DB52.DBB 14	"PNO_IM_RD_DATA" IM_DATA[15]	HEX	D#10#38	
DB52.DBB 15	"PNO_IM_RD_DATA" IM_DATA[16]	HEX	D#10#20	

Figure 31: Example of a completed I&amp;M 0 read action

### 6.8.2.2 I&M Write Record

I&M data can be written via the standard WRREC (SFB53) function block in **STEP 7**. The logical address of the slot/sub-slot (ID), the I&M index (INDEX) and the data length (LEN) must be used as handover parameters. The return parameters contain a status or error message.

#	Operand	Symbol	Anzeigeformat	Statuswert	Steuwert
11	// FB inputs				
12	DB153.DBX 0.0	"PNIO_M_WR_DB".REQ	BOOL	false	true
13	DB153.DBD 2	"PNIO_M_WR_DB".ID	DEZ	L#0165	L#0165
14	DB153.DBV 6	"PNIO_M_WR_DB".M_INDEX	HEX	W#16#AFF1	W#16#AFF1
15	DB153.DBV 8	"PNIO_M_WR_DB".LEN	DEZ	60	54
16					
17	// FB outputs				
18	DB153.DBX 10.0	"PNIO_M_WR_DB".DONE	BOOL	true	
19	DB153.DBX 10.1	"PNIO_M_WR_DB".BUSY	BOOL	false	
20	DB153.DBX 10.2	"PNIO_M_WR_DB".ERROR	BOOL	false	
21	DB153.DBD 12	"PNIO_M_WR_DB".STATUS	HEX	DW#16#00000000	
22					
23	// Data header				
24	DB53.DBB 0	"PNIO_M_WR_DATA".M_DATA[1]	HEX	B#16#00	
25	DB53.DBB 1	"PNIO_M_WR_DATA".M_DATA[2]	HEX	B#16#21	
26	DB53.DBB 2	"PNIO_M_WR_DATA".M_DATA[3]	HEX	B#16#00	
27	DB53.DBB 3	"PNIO_M_WR_DATA".M_DATA[4]	HEX	B#16#38	
28	DB53.DBB 4	"PNIO_M_WR_DATA".M_DATA[5]	HEX	B#16#01	
29	DB53.DBB 5	"PNIO_M_WR_DATA".M_DATA[6]	HEX	B#16#00	
30					
31	// Data record				
32	DB53.DBB 6	"PNIO_M_WR_DATA".M_DATA[7]	ZEICHEN	'S'	'S'
33	DB53.DBB 7	"PNIO_M_WR_DATA".M_DATA[8]	ZEICHEN	'A'	'A'
34	DB53.DBB 8	"PNIO_M_WR_DATA".M_DATA[9]	ZEICHEN	'M'	'M'
35	DB53.DBB 9	"PNIO_M_WR_DATA".M_DATA[10]	ZEICHEN	'P'	'P'
36	DB53.DBB 10	"PNIO_M_WR_DATA".M_DATA[11]	ZEICHEN	'L'	'L'
37	DB53.DBB 11	"PNIO_M_WR_DATA".M_DATA[12]	ZEICHEN	'E'	'E'
38	DB53.DBD 12	"PNIO_M_WR_DATA".M_DATA[13]	HEX	D#16#20	
39	DB53.DBD 13	"PNIO_M_WR_DATA".M_DATA[14]	HEX	D#16#20	
40	DB53.DBD 14	"PNIO_M_WR_DATA".M_DATA[15]	HEX	D#16#20	
41	DB53.DBD 15	"PNIO_M_WR_DATA".M_DATA[16]	HEX	D#16#20	

Figure 32: Example of a completed I&amp;M 1 write action

## 6.9 Fast Start-Up (FSU) / Prioritized Start-Up

The LioN-P modules with Fast Start-Up (FSU) support an optimized system start-up. This guarantees a faster restart after the power supply is restored.

Fast Start-Up can be activated for the LioN-P modules with **PROFINET interface [X1] > Advanced options > Interface options** over **Prioritized start-up**.

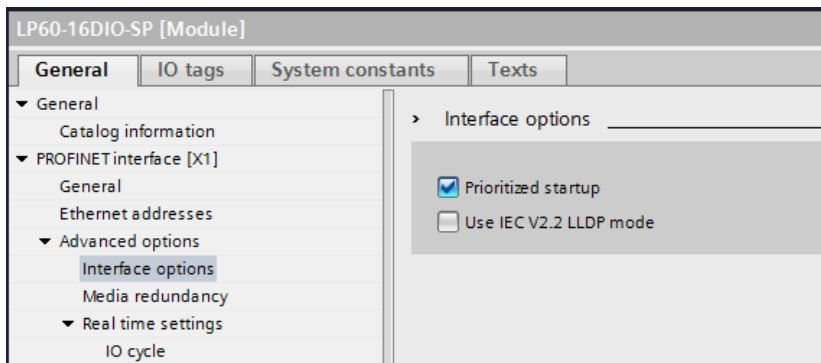

## 7 Bit assignment

The LioN-P IO-Link masters use a modular device model. Slot 1/sub-slot 1 contains the IO-Link master status and control module. This module always has 4 bytes of input data and 4 bytes of output data; it is always statically configured on selecting a LioN-P IO-Link Master from the GSD file.

The IO-Link ports use the following sub-slots 2 through 9 of slot 1; they can have a different operating mode and data length depending on the configuration.

### 7.1 Process data Status and Control module, slot 1/sub-slot 1

#### 7.1.1 Digital IO mapping mode 1 (default mapping)

If mapping mode 1 was selected in the device configuration, the data of the Status and Control module are transferred as follows.

The screenshot shows a configuration window titled 'Baugruppenparameter' with a sub-section 'General Device Settings'. It contains four dropdown menus:

- Digital I/O Bit Mapping Mode: MM1: Default Mapping (port-based: n.a., X1-B, r)
- Force Mode: Enabled
- Web Interface: Enabled
- Digital Output Restart Mode: Automatic Restart after Failure

##### 7.1.1.1 Input data of the Status/Control modules

Bit	7	6	5	4	3	2	1	0
Port	X4	X4	X3	X3	X2	X2	X1	X1
Pin	2	4	2	4	2	4	2	4
Channel	4	4	3	3	2	2	1	1

Table 17: Byte 0, Digital Input Status

Bit	7	6	5	4	3	2	1	0
Port	X8	X8	X7	X7	X6	X6	X5	X5
Pin	2	4	2	4	2	4	2	4
Channel	8	8	7	7	6	6	5	5

*Table 18: Byte 1, Digital Input Status*

Bit	7	6	5	4	3	2	1	0
Port	X8	X7	X6	X5	X4	X3	X2	X1
Pin	4	4	4	4	4	4	4	4
Channel	8	7	6	5	4	3	2	1

*Table 19: Byte 2, IOL-COM state*

Bit	7	6	5	4	3	2	1	0
Port	X8	X7	X6	X5	X4	X3	X2	X1
Pin	4	4	4	4	4	4	4	4
Channel	8	7	6	5	4	3	2	1

*Table 20: Byte 3, IOL PD valid*

Key:

- ▶ The digital input data return the status of the digital inputs.
- ▶ The data in the cells highlighted in blue are only available for LiON-P 60 devices are representing the output status.
- ▶ Channel: Channel number of the PROFINET device model used for diagnostic messages.
- ▶ IOL-COM state: The "IOL-COM state" indicates whether the port has established communication with the IO-Link device.
- ▶ IOL-PD valid: The "IOL-PD valid" valid information indicates whether the IO-Link process data of the corresponding port are valid.

**7.1.1.2 Output data of the Status/Control modules (except 0980 ESL 3x8-121)**

Bit	7	6	5	4	3	2	1	0
Port	X4	X4	X3	X3	X2	X2	X1	X1
Pin	-	4	-	4	-	4	-	4
Channel	-	4	-	3	-	2	-	1

Table 21: Byte 0, Digital Output State

Bit	7	6	5	4	3	2	1	0
Port	X8	X8	X7	X7	X6	X6	X5	X5
Pin	2	4	2	4	2	4	2	4
Channel	8	8	7	7	6	6	5	5

Table 22: Byte 1, Digital Output State

Bit	7	6	5	4	3	2	1	0
Port	X8	X7	X6	X5	X4	X3	X2	X1
Pin	4	4	4	4	4	4	4	4
Channel	8	7	6	5	4	3	2	1

Table 23: Byte 2, COM mode



Bit	7	6	5	4	3	2	1	0
Port	-	-	-	-	-	-	-	-
Pin	-	-	-	-	-	-	-	-
Channel	-	-	-	-	-	-	-	-

Table 24: Byte 3, reserved

#### Key:

- ▶ The data in the cells highlighted in blue are only available for LioN-P 60 devices.
- ▶ **Byte 0 (Pin 4, C/Q mode):** The digital output on the corresponding port can be controlled via the process data. The IO link port must be configured as a digital output in the Engineering Tool.
- ▶ **Byte 2 (COM mode)** can be used to temporarily (as long as the corresponding COM control bit is set) switch one or more IO-link ports previously in digital input (DI) operating mode to IO-Link operating mode. As a result, it is possible to establish communications with the connected IO-Link device for parameterization. No process data are exchanged during this time.

**7.1.1.3 Output data of the Status/Control modules for 0980 ESL  
3x8-121**

Bit	7	6	5	4	3	2	1	0
Port	X4	X4	X3	X3	X2	X2	X1	X1
Pin	-	-	-	-	-	-	-	-
Channel	-	-	-	-	-	-	-	-

*Table 25: Byte 0, Digital Output State*

Bit	7	6	5	4	3	2	1	0
Port	X8	X8	X7	X7	X6	X6	X5	X5
Pin	2	-	2	-	2	-	2	-
Channel	8	-	6	-	4	-	2	-

*Table 26: Byte 1, Digital Output State*

Bit	7	6	5	4	3	2	1	0
Port	X8	X7	X6	X5	X4	X3	X2	X1
Pin	4	4	4	4	4	4	4	4
Channel	8	7	6	5	4	3	2	1

*Table 27: Byte 2, COM mode*

Bit	7	6	5	4	3	2	1	0
Port	-	-	-	-	-	-	-	-
Pin	-	-	-	-	-	-	-	-
Channel	-	-	-	-	-	-	-	-

Table 28: Byte 3, reserved

Key:

- ▶ **Byte 0 (Pin 4, C/Q mode):** The digital output on the corresponding port can be controlled via the process data. The IO link port must be configured as a digital output in the Engineering Tool.
- ▶ **Byte 2 (COM mode)** can be used to temporarily (as long as the corresponding COM control bit is set) switch one or more IO-link ports previously in digital input (DI) operating mode to IO-Link operating mode. As a result, it is possible to establish communications with the connected IO-Link device for parameterization. No process data are exchanged during this time.

### 7.1.2 Digital IO mapping mode 2 (E2C compatibility)

If mapping mode 2 was selected in the device configuration, the data of the Status and Control module are transferred as follows.

#### 7.1.2.1 Input data of the Status/Control modules

Bit	7	6	5	4	3	2	1	0
Port	X8	X7	X6	X5	X4	X3	X2	X1
Pin	4	4	4	4	4	4	4	4
Channel	8	7	6	5	4	3	2	1

Table 29: Byte 0, Digital Input Status

Bit	7	6	5	4	3	2	1	0
Port	X8	X7	X6	X5	X4	X3	X2	X1
Pin	2	2	2	2	2	2	2	2
Channel	8	7	6	5	4	3	2	1

Table 30: Byte 1, Digital Input Status

Bit	7	6	5	4	3	2	1	0
Port	X8	X7	X6	X5	X4	X3	X2	X1
Pin	4	4	4	4	4	4	4	4
Channel	8	7	6	5	4	3	2	1

Table 31: Byte 2, IOL-COM state

Bit	7	6	5	4	3	2	1	0
Port	X8	X7	X6	X5	X4	X3	X2	X1
Pin	4	4	4	4	4	4	4	4
Channel	8	7	6	5	4	3	2	1

Table 32: Byte 3, IOL PD valid

**Key:**

- ▶ The digital input data return the status of the digital inputs.
- ▶ The data in the cells highlighted in blue are only available for LiON-P 60 devices and are representing the output status.
- ▶ Channel: Channel number of the PROFINET device model used for diagnostic messages.
- ▶ IOL-COM state: The "IOL-COM state" indicates whether the port has established communication with the IO-Link device.
- ▶ IOL-PD valid: The "IOL-PD valid" information indicates whether the IO-Link process data of the corresponding port are valid.

**7.1.2.2 Output data of the Status/Control modules (except 0980 ESL 3x8-121)**

Bit	7	6	5	4	3	2	1	0
Port	X8	X7	X6	X5	X4	X3	X2	X1
Pin	4	4	4	4	4	4	4	4
Channel	8	7	6	5	4	3	2	1

*Table 33: Byte 0, Digital Output State*

Bit	7	6	5	4	3	2	1	0
Port	X8	X7	X6	X5	X4	X3	X2	X1
Pin	2	2	2	2	-	-	-	-
Channel	8	7	6	5	-	-	-	-

*Table 34: Byte 1, Digital Output Status*

Bit	7	6	5	4	3	2	1	0
Port	X8	X7	X6	X5	X4	X3	X2	X1
Pin	4	4	4	4	4	4	4	4
Channel	8	7	6	5	4	3	2	1

*Table 35: Byte 2, COM mode*

Bit	7	6	5	4	3	2	1	0
Port	-	-	-	-	-	-	-	-
Pin	-	-	-	-	-	-	-	-
Channel	-	-	-	-	-	-	-	-

*Table 36: Byte 3, reserved***Key:**

- ▶ The data in the cells highlighted in blue are only available for LioN-P 60 devices.
- ▶ **Byte 0 (Pin 4, C/Q mode):** The digital output on the corresponding port can be controlled via the process data. The IO link port must be configured in digital output mode.
- ▶ **Byte 2 (COM mode)** can be used to temporarily (as long as the corresponding COM control bit is set) switch one or more IO-link ports previously in digital input (DI) operating mode to IO-Link operating mode. As a result, it is possible to establish communication with the connected IO-Link device for parameterization. No process data are exchanged during this time.

**7.1.2.3 Output data of the Status/Control modules for 0980 ESL  
3x8-121**

Bit	7	6	5	4	3	2	1	0
Port	X4	X4	X3	X3	X2	X2	X1	X1
Pin	-	-	-	-	-	-	-	-
Channel	-	-	-	-	-	-	-	-

*Table 37: Byte 0, Digital Output Status*

Bit	7	6	5	4	3	2	1	0
Port	X8	X7	X6	X5	X4	X3	X2	X1
Pin	2	2	2	2	-	-	-	-
Channel	8	7	6	5	-	-	-	-

*Table 38: Byte 1, Digital Output Status*

Bit	7	6	5	4	3	2	1	0
Port	X8	X7	X6	X5	X4	X3	X2	X1
Pin	4	4	4	4	4	4	4	4
Channel	8	7	6	5	4	3	2	1

*Table 39: Byte 2, COM mode*

Bit	7	6	5	4	3	2	1	0
Port	-	-	-	-	-	-	-	-
Pin	-	-	-	-	-	-	-	-
Channel	-	-	-	-	-	-	-	-

Table 40: Byte 3, reserved

Key:

- ▶ **Byte 0 (Pin 4, C/Q mode):** The digital output on the corresponding port can be controlled via the process data. The IO link port must be configured in digital output mode.
- ▶ **Byte 2 (COM mode)** can be used to temporarily (as long as the corresponding COM control bit is set) switch one or more IO-link ports previously in digital input (DI) operating mode to IO-Link operating mode. As a result, it is possible to establish communication with the connected IO-Link device for parameterization. No process data are exchanged during this time.

## 7.2 Process data IO-Link ports, slot 1/sub-slot 2 - sub-slot 9

The process data lengths of the IO-Link ports in COM mode depend on the IO-Link port configurations X 1 - X 8. Data lengths between 1 - 32 bytes of input data and/or 1 - 32 bytes of output data are configurable.

The data content can be taken from the descriptions of the IO-Link devices. If a precise data length is not available for the IO-Link device configuration, always select the next larger data length.

The mapping mode selected for the Status/Control modules has no influence on the process data of the IO-Link ports.



## 8 Diagnostics processing

### 8.1 Error of the system/sensor power supply

The voltage value for the incoming system/sensor power supply is also monitored globally. If the voltage drops below approx. 18 V, or exceeds approx. 30 V, an error message is generated.

The green  $U_S$  indicator is off.

The error message has no effect on the outputs.



**Caution:** It must definitely be ensured that the supply voltage, measured at the most remote participant is not below 18 V DC from the perspective of the system power supply.

The following group diagnostic message is generated:

Channel number of diagnosis	0x8000 (diagnosis not channel-specific)
Channel related diagnosis code	0x0002
Channel related diagnosis code message	Undervoltage
Extended description	Voltage fault of auxiliary power supply ( $U_{Aux}$ ), detected by IO-Link master.

### 8.2 Error of the auxiliary/actuator power supply

The voltage value for the incoming auxiliary/actuator power supply is also monitored globally. If  $U_{Aux}$  diagnostic messaging is enabled, an error message is generated if the voltage drops below approx. 18 V or exceeds approx. 30 V.

The  $U_{Aux}$  indicator shows red. If output channels are enabled, additional error messages caused by the voltage failure are generated on the IO ports.

$U_{Aux}$  diagnostic messaging is disabled by default and must be enabled via parameterization.

The following group diagnostic message is generated:

Channel number of diagnosis	0x8000 (diagnosis not channel-specific)
Channel related diagnosis code	0x0103
Channel related diagnosis code message	Undervoltage
Extended description	Voltage fault of auxiliary power supply ( $U_{Aux}$ ), detected by IO-Link master.

### 8.3 Overload/short-circuit of the IO port sensor supply outputs

In case of an overload or a short circuit between pin 1 and pin 3 on the ports (X1 - X8), the following channel-specific diagnostic messages are generated:

Channel number of diagnosis	0x01 - 0x08
Channel related diagnosis code	0x01
Channel related diagnosis code message	Short circuit
Extended description	Short circuit or overload of sensor power supply at Pin 1 of IO-Port detected by IO-Link master

Alternatively, the following error message is generated:

Channel number of diagnosis	0x01 - 0x08
Channel related diagnosis code	0x0113
Channel related diagnosis code message	High temperature limit of IO-Link port driver exceeded (short circuit or overload), detected by IO-Link master

## 8.4 Overload/short circuit of the digital 500 mA outputs

The digital outputs on the C/Q pin (except 0980 ESL 3x8-121) are short circuit and overload protected. In case of a fault, the output is automatically switched off and cyclically automatically switched back on.

The device sends the following PROFINET diagnostic message in case of a fault:

Channel number of diagnostics	0x01 - 0x08
Channel related diagnostic code	0x010A
Channel related diagnostic code message	Short circuit or overload of digital output at Pin 4 /Ch. A of IOL-Port in DIO mode, detected by IO-Link master

## 8.5 Overload/short circuit of the digital outputs

There are four 2 A outputs available for variants 0980 ESL 3x9-121 or 1.6 A outputs available for variants 0980 ESL 3x8-121 on the Class B ports of the LioN-P 60 devices.

A channel error is determined by comparing the target value set by a controller and the actual value of an output channel.

Target value	Actual value	Comment
Active	Active	OK, no diagnosis
Off	Off	OK, no diagnosis
Active	Off	Short-circuit Channel indicator is red. Channel error bit in the diagnosis is set. Channel is locked after the error is rectified.

*Table 41: Interpretation of channel errors*

When an output channel is activated (rising edge of the channel state) or deactivated (falling edge), the channel errors are filtered for the period that you set using the "Surveillance-Timeout" parameter during the configuration of the module. The value of this parameter can range from 0 to 255 ms; the factory setting is 80 ms.

The filter is used to avoid premature error messages when a capacitive load is activated or an inductive load is deactivated, and during other voltage peaks when a status changes.

In static state of the output channel, that is, while the channel is permanently switched on or off, the filter time between error detection and the diagnostic message is typically 5-10 ms.

The device sends the following PROFINET diagnostic message in this fault case:

Channel number of diagnosis	0x05 - 0x08
Channel related diagnosis code	0x0109
Channel related diagnosis code message	Short circuit or overload of digital output at Pin 2/Ch. B of Type B IO-Port, detected by IO-Link Master

## 8.6 Overload/short circuit of the Type B port aux. power supply

### 8.6.1 For LioN-P 30 devices

In case of an overload or a short circuit between pin 2 and pin 5 on these ports (X5 - X8), the following group diagnostic message (non channelspecific) is generated:

Channel number of diagnostics	0x8000 (diagnostics not channel-specific)
Channel related diagnostic code	0x0108
Channel related diagnostic code message	Short circuit or overload of auxiliary power supply at Pin 2 of type B IO-Ports, detected by IO-Link Master

### 8.6.2 For LioN-P 60 devices

In case of an overload or a short circuit between pin 2 and pin 5 on these ports (X5 - X8), the following channel-specific diagnostic message is generated:

Channel number of diagnostics	0x05 - 0x08
Channel related diagnostic code	0x0108
Channel related diagnostic code message	Short circuit or overload of auxiliary power supply at Pin 2 of type B IO-Ports, detected by IO-Link Master

## 8.7 IO-Link C/Q error

If an IO-Link device in COM mode is unplugged, an incorrect IO-Link device is plugged in, or an electrical fault occurs on the C/Q (Pin 4) line, for example, due to a short circuit, then following error message is generated:

Channel number of diagnostics	0x01 - 0x08
Channel related diagnostic code	0x0006
Channel related diagnostic code message	Line break
Extended description	Missing/wrong device, broken wire or short circuit/overload at Pin 4/ Ch. A of IOL-Port, detected by IO-Link Master.

## 8.8 IO-Link Device Diagnostics

Diagnostics of IO-Link devices that the device sends to the IO-Link Master are reported via a standard channel diagnostic and an extended channel diagnostic.

Standard channel diagnostic message:

Channel number of diagnostics	0x01 - 0x08
Channel related diagnostic code	Depends on IO-Link device diagnostics
Channel related diagnostic code message	Depends on IO-Link device diagnostics

Extended channel diagnostic message:

Channel number of diagnostics	0x01 - 0x08
Ext. channel related diagnostic code	0x9000
Ext. channel value	EventCode << 16   ChannelNumber << 8   EventQualifier

### Event Code

Diagnostic code reported by the IO-Link device. Use the IO-Link device documentation to interpret the error message.

### Channel Number

1-8 of the IO-Link Master port whose connected device is reporting an error.

Bit	Mode		Type		Res.		Instance	
	7	6	5	4	3	2	1	0

Table 42: Event Qualifier

Value	Definition
0	Unknown
1	Phy
2	DL
3	L
4	Application
5 ... 7	reserved

Table 43: Event Qualifier Instance

### Event Qualifier Res.

This bit is reserved and must be set to 0.

Value	Definition
0	Reserved
1	Information
2	Warning
3	Error

Table 44: Event Qualifier Type

Value	Definition
0	Reserved
1	Event single shot
2	Event disappears
3	Event appears

Table 45: Event Qualifier Mode



# 9 Port Configuration Tool

The TMG IO-Link Device Tool > V5 is a PC engineering software for configuring IO-Link devices via the Belden IO-Link Master. The engineering software communicates via UDP over the Ethernet interface of the IO-Link master. Therefore no additional hardware neither a running real time protocol is needed.

The tool can be used both as a standalone program or can be integrated via TCI (Tool Calling Interface) in PLC programming software such as STEP 7 or TIA Portal.

The key technological element for the operation of the connected devices is the mandatory IODD (IO Device Description) file.

The IODD is accepted worldwide. The Belden IO-Link Device Tool supports IO-Link V1.0 (IODDs V1.0.1) and IO-Link V1.1 (IODDs V1.1).

Main functions:

- ▶ IO-Link Device project management
- ▶ Port configuration of IO-Link masters (without connected real-time controller)
- ▶ Operation and configuration of IO-Link Devices via IODD

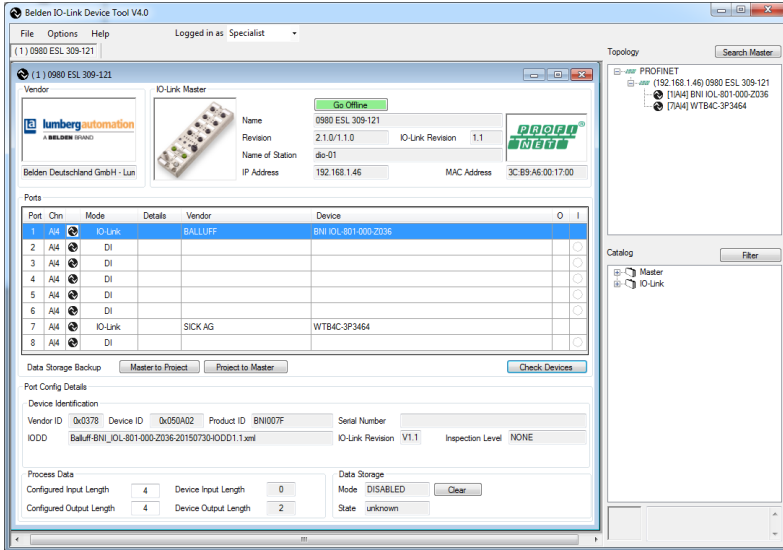
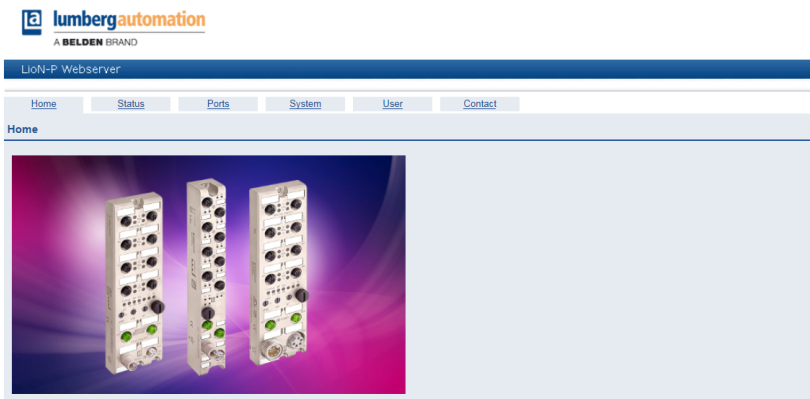

Figure 33: Port configuration tool - Main window

## 10 The integrated web server

The LioN-P modules are equipped with an integrated web server which makes functions available for the configuration of modules and display of status and diagnostic information.

Enter `http://` followed by the IP address, such as `http://192.168.1.5`, in your web browser's address bar. If the Home page of the module is not displayed, check your browser and firewall settings.



The web interface provides an overview of the configuration and status of the module. Also, certain settings can be made. It is also possible to use the web interface to trigger a reboot, reset to the factory defaults, or perform a firmware update.

## 10.1 The Status page

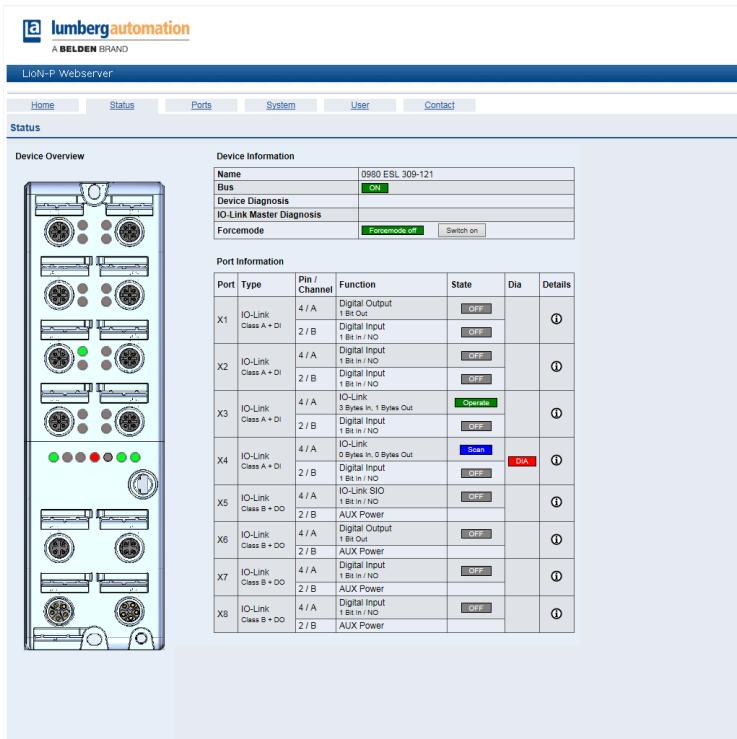

The screenshot shows the 'Status' page of the LiON-P Webserver. The page header includes the Lumberg Automation logo and navigation tabs for Home, Status, Ports, System, User, and Contact. The main content area is titled 'Device Information' and 'Port Information'.

**Device Information**

Name	D990 ESL_309-121
Bus	OK
Device Diagnosis	
IO-Link Master Diagnosis	
Forcemode	Forcemode off <input type="button" value="Switch on"/>

**Port Information**

Port	Type	Pin / Channel	Function	State	Diag	Details
X1	IO-Link Class A = CI	4 / A	Digital Output 1 Bit Out	<input type="button" value="OFF"/>		Ⓢ
		2 / B	Digital Input 1 Bit In / NG	<input type="button" value="OFF"/>		
X2	IO-Link Class A = CI	4 / A	Digital Input 1 Bit In / NG	<input type="button" value="OFF"/>		Ⓢ
		2 / B	Digital Input 1 Bit In / NG	<input type="button" value="OFF"/>		
X3	IO-Link Class A = DI	4 / A	IO-Link 2 Bytes In, 1 Bytes Out	<input type="button" value="Operate"/>		Ⓢ
		2 / B	Digital Input 1 Bit In / NG	<input type="button" value="OFF"/>		
X4	IO-Link Class B = DI	4 / A	IO-Link 0 Bytes In, 0 Bytes Out	<input type="button" value="Scan"/>	OK	Ⓢ
		2 / B	Digital Input 1 Bit In / NG	<input type="button" value="OFF"/>		
X5	IO-Link Class B = DO	4 / A	IO-Link SIO 1 Bit In / NG	<input type="button" value="OFF"/>		Ⓢ
X6	IO-Link Class B = DO	4 / A	Digital Output 1 Bit Out	<input type="button" value="OFF"/>		Ⓢ
		2 / B	AUX Power			
X7	IO-Link Class B = DO	4 / A	Digital Input 1 Bit In / NG	<input type="button" value="OFF"/>		Ⓢ
		2 / B	AUX Power			
X8	IO-Link Class B = DO	4 / A	Digital Input 1 Bit In / NG	<input type="button" value="OFF"/>		Ⓢ
		2 / B	AUX Power			

The status page provides a quick overview of the current state of the module.

The left side shows a graphical representation of the module with all its LEDs and the positions of the rotary encoding switches.

The right side shows the "Device Information" table with some basic data for the module; for example, the variant, the cyclic communication status and a diagnostic indicator. The indicator shows whether diagnostics for the module exist.

The "Port Information" table shows the configuration and state of all the module's IO ports.

## Forcemode

The Forcemode is a test option for the plant engineer, the input and output data can be set from this web page. The physical input data and the logical output data from the controller can be overruled in this mode. For safety reasons this mode can be disabled by parametrization.

Column	Information
Port	Name of port
Type	Type of port. This can be DIO, IOL A or IOL B depending on the variant. The +DO supplement indicates that an additional digital output is available here.
Pin	Corresponding pin on the M8/M12 slot
Function	Function configured via control
State	Current status. ON or OFF is displayed here for digital inputs or outputs. The COM status is displayed for IO-Link connections.
Dia	The diagnostics indicator shows whether diagnostics exist for this channel.
Details	This link can be used to jump directly to the corresponding detailed view for this port. More information is then available.



**Warning:** Using of the force mode can result in serious personal injury or damage to the equipment. Be careful when using the force mode.



LiOn-P Webserver

Home Status Ports System User Contact

Status

Device Overview

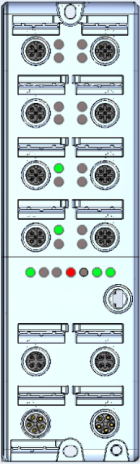

Device Information

Name	0980 ESL 309-121
Bus	IO-Link
Device Diagnosis	<ul style="list-style-type: none"> <li>Forcemode active</li> </ul>
IO-Link Master Diagnosis	
Forcemode	Forcemode on <input type="button" value="Switch off"/>

Port Information

Port	Type	Pin / Channel	Function	State	Dia	Details
X1	IO-Link Class A + Di	4 / A	Digital Output 1 Bit Out	OFF 0 1		ⓘ
		2 / B	Digital Input 1 Bit In / NO	OFF 0 1		
X2	IO-Link Class A + Di	4 / A	Digital Input 1 Bit In / NO	OFF 0 1		ⓘ
		2 / B	Digital Input 1 Bit In / NO	OFF 0 1		
X3	IO-Link Class A + Di	4 / A	IO-Link 0 Bytes In, 0 Bytes Out	Good	OK	ⓘ
		2 / B	Digital Input 1 Bit In / NO	OFF 0 1	OK	
X4	IO-Link Class A + Di	4 / A	IO-Link 0 Bytes In, 0 Bytes Out	Good	OK	ⓘ
		2 / B	Digital Input 1 Bit In / NO	OFF 0 1	OK	
X5	IO-Link Class B + DO	4 / A	IO-Link SIO 1 Bit In / NO	OFF 0 1		ⓘ
		2 / B	AUX Power			
X6	IO-Link Class B + DO	4 / A	Digital Output 1 Bit Out	OFF 0 1		ⓘ
		2 / B	AUX Power			
X7	IO-Link Class B + DO	4 / A	Digital Input 1 Bit In / NO	OFF 0 1		ⓘ
		2 / B	AUX Power			
X8	IO-Link Class B + DO	4 / A	Digital Input 1 Bit In / NO	OFF 0 1		ⓘ
		2 / B	AUX Power			

## 10.2 The Ports page

The screenshot shows the Lumberg Automation webserver interface. At the top, there is a navigation bar with tabs for Home, Status, Ports, System, User, and Contact. Below this, the 'IO-Link' section is active, displaying 'Show details for port' and a row of radio buttons for ports X1 through X8, with X3 selected. The main content area is divided into two columns of information:

Port Information		IO-Link	
Port	X3	Vendor ID	0x1 / (dec: 1)
Type	IO-Link	Device ID	0x110903
Class	Class A + DI	Vendor Name	Pepper+Fuchs
Diagnosis		Vendor Text	www.pepper-fuchs.com/io-link
Pin 4 / Channel A		Product Name	OMT100-R100-2EP-IO-0.3M-V1
Function	IO-Link	Product ID	267075-100080
State	3 Bytes In, 1 Bytes Out	Product Text	Distance sensor
Pin 2 / Channel B		Serial No	4000031420097
Function	Digital Input	HW Revision	FW01.00
State	1 Bit In / NO	FW Revision	FW01.00
	<input type="checkbox"/> 0 <input checked="" type="checkbox"/> 1	Application Name (Tag)	Your automation, our passion <input type="text"/> <input type="button" value="Set"/>
		Input Data	<input type="text" value="02 00 0b"/>
		Output Data	<input type="text" value="00"/>
		Index:	<input type="text" value=""/> Subindex: <input type="text" value="0"/>
		Parameter Read/Write	<input type="button" value="Read"/> <input type="button" value="Write"/>
			<input type="text"/>

Detailed port information is shown here.

**Port Diagnostics** show incoming and outgoing diagnostics in clear text. **Pin 2** and **Pin 4** contain information about the configuration and state of the port. For IO-Link ports, additional information relating to the connected sensor and the process data is displayed.

## 10.3 The System page

The screenshot shows the 'LioN-P Webservice' interface. At the top, there is a navigation bar with 'Home', 'Status', 'Ports', 'System', 'User', and 'Contact' tabs. The 'System' tab is selected. Below the navigation bar, the 'System' page is displayed. It is divided into several sections:

- General Information:** This section contains a table with the following data:
 

Firmware	
Name	LioN-P PROFINET IO-Link Master
Version	V.2.1.0.3 - 17.10.2016 / Web: 13
Device	
Name	0900 ESL 309-121
Ordering Number	534 878 004
Hardware	V.1.0
Serial Number	12345
Production Date	32 / 2015
Ethernet	
MAC Address	3C B9 A6 00 33 AE
Port 0	100M Full
Port 1	Link Down
Network	
IP-Address	192.168.1.5
Subnetmask	255.255.255.0
Gateway	0.0.0.0
Fieldbus	
Name of Station	
State	Not Connected
- Restart device:** A checkbox labeled 'Confirm to restart the device. All connections will be closed.' is present, followed by a 'Restart' button.
- Reset configuration to factory defaults:** A checkbox labeled 'Confirm to reset the device. All configuration data will be overwritten by default values!' is present, followed by a 'Factory Reset' button.
- Firmware update:** A 'FW-Update' button is present.

The System page shows basic information for the module. The current firmware, its version, and the firmware date can be viewed below **Firmware** as well as the version of the web interface.

All the information about the module itself is located below **Device**.

On this page you have the option to access the following values and parameters:

### Restart Device

The module initializes a software reset.

### Reset to Factory Settings

The module restores to the default factory settings.





**Attention:** During the factory reset process the BF/MS/RUN LED is cyclic triple flashing red. After completion the factory reset the BF/MS/RUN LED is cyclic triple flashing green. Afterwards perform a power cycle and wait 10 seconds.

## Firmware Update

The module initializes a Firmware update.

For a firmware update choose the \*.ZIP container available on our website or ask our support team. Afterwards follow the instructions shown on your screen.

Firmware Update

Choose file to load:

## 10.4 The User page

lumbergautomation  
A BELDEN BRAND

LioN-P Webservice

Home Status Ports System User Contact

Users

Users

Username	Permissions	Edit	Del
admin	Admin		
User1	Write permissions		
User2	Admin		

Create User

Login:  Permission: Write

The User page provides the user management of the web interface. New users with access rights **Admin** or **Write** can be added here. For security reasons please change the default admin password immediately after configuring the device.

# 11 Technical data

## 11.1 General

Protection class (This only applies if the connectors are screwed together or if protective caps are used.) <sup>1</sup>	For all Digital LioN-P modules:	IP65, IP67
	Only for modules with M12-L power connector (not for modules with 7/8" power connector):	IP69
Ambient temperature (Operation)	-4° F to +158° F (-20° C to +70° C)	
Ambient temperature - EEC variants (Operation)	-40° F to +158° F (-40° C to +70° C)	
Weight	LioN-P 30:	480g
	LioN-P 60:	500g
Ambient moisture	max. 98% RH (for U <sub>L</sub> certification: max. 80% RH)	
Housing material	Die-cast zinc	
Surface finish	Matt nickel	
Flammability class	UL 94 (IEC 61010)	
Vibration resistance (oscillation) DIN EN 60068-2-6 (2008-11)	15 g / 5-500 Hz	
Shock resistance DIN EN 60068-2-27 (2010-02)	50 g / 11 ms +/- X,Y,Z	
Torques	M4 fixing screws:	1 Nm
	M4 ground connection:	1 Nm
	M8 connector:	0.5 Nm
	M12 connector:	0.5 Nm

*Table 46: General information*

<sup>1</sup> Not under UL investigation.

## 11.2 PROFINET protocol

Protocol	PROFINET IO Device V2.3
Conformance Class	C (CC-C)
Netload Class	2
Update cycle	1 ms
GSDML file	GSDML-V2.3x-LumbergAutomation-LioN-Pyyyyymmdd.xml
Transmission rate	100 Mbit/s, full duplex
Transmission procedure Autonegotiation	100BASE-TX is supported
Vendor ID	16A <sub>H</sub>
Device ID	0305 <sub>H</sub> (same for all LioN-P modules)
Supported Ethernet protocols	<ul style="list-style-type: none"> <li>Ping</li> <li>ARP</li> <li>LLDP</li> <li>SNMPv1 (network diagnostics) <ul style="list-style-type: none"> <li>▶ Read Community: public</li> <li>▶ Write Community: private</li> </ul> </li> <li>DCP</li> <li>HTTP</li> <li>TCP/IP</li> <li>MRP Client</li> </ul>
PROFINET feature	<ul style="list-style-type: none"> <li>Fast Start-UP</li> <li>Shared Device</li> </ul>
Switch functionality	<ul style="list-style-type: none"> <li>Integrated</li> <li>IRT is supported</li> </ul>
PROFINET interface Connections Autocrossing	<ul style="list-style-type: none"> <li>2 M12 sockets, 4-pin, D-coded (see pin assignments)</li> <li>2 M12 Hybrid male/female, 8-pin</li> <li>is supported</li> </ul>
Electrically isolated Ethernet ports -> PE	2000 V DC

Table 47: PROFINET protocol

## 11.3 Power supply of the module electronics/sensors

Nominal voltage $U_S$	24 V DC (SELV/PELV)	
Voltage range	18-30 V DC	
Power consumption of module electronics	at 24 V DC:	typ. 95 mA
	at 30 V DC:	typ. 120 mA
Voltage level of the sensor power supply	Min. ( $U_S - 1.5$ V)	
Current consumption sensor system (L+ / Pin 1)	max. 500 mA per port (at ambient = 30° C) (for $U_L$ application 400 mA)	
Short circuit/overload protection of sensor ver.	Yes, per port	
Reverse polarity protection	Yes	
Operational indicator ( $U_S$ )	LED green:	$18\text{ V } (+/- 1\text{ V}) < U_S < 30\text{ V } (+/- 1\text{ V})$
	LED red:	$U_S < 18\text{ V } (+/- 1\text{ V})$ or $U_S > 30\text{ V } (+/- 1\text{ V})$
Port X03, X04 or Port X01, X02 (LioN-P 30 only)	M12 power, connector/socket, 5-pole  M12 hybrid, connector/socket, 8-pole	

*Table 48: Information on the power supply of the module electronics/sensors*

## 11.4 Power supply of the type B ports (auxiliary supply)

Nominal voltage $U_{Aux}$	24 V DC (SELV/PELV)
Voltage range	18-30 V DC
Reverse polarity protection	Yes
Operational indicator ( $U_{Aux}$ )	LED green: $18\text{ V (+/- 1 V)} < U_{Aux} < 30\text{ V (+/- 1 V)}$ LED red: $U_{Aux} < 18\text{ V (+/- 1 V)}$ or $U_{Aux} > 30\text{ V (+/- 1 V)}$ * if "Report $U_{Aux}$ supply voltage fault" is enabled.
Port X03, X04 or Port X01, X02 (LioN-P 30 only)	M12 power, connector/socket, 5-pole  M12 hybrid, connector/socket, 8-pole

*Table 49: Information on the power supply of the type B ports (auxiliary supply)*

## 11.5 IO-Link Master Ports (X1 - X8, Ch. A / C/Q / Pin 4)

Port X01 – X08 or Port X01, X08 (LioN-P 30 only)	M12 socket, 5-pin  M8 socket, 5-pin
--	---

*Table 50: IO-Link Master Ports (X1-X8, Ch. A / C/Q / Pin 4)*

### 11.5.1 Configured as a digital input

Input connection	Type 1 as per IEC 61131-2
Nominal input voltage	24 V DC
Input current	Typically 3 mA
Channel type	Normally open, p-switching
Number of digital inputs	8
Status indicator	Yellow LED
Diagnostic indicator	Red LED per channel

Table 51: IO-Link Master Ports configured as digital inputs

### 11.5.2 Configured as a digital output (except 0980 ESL 3x8-121)



**Attention:** Power is supplied to the 500 mA outputs via the  $U_S$  power supply.

Output type	Normally open, p-switching
Nominal output current per channel	
Signal status "1"	Min. ( $U_S - 1 V$ )
Signal status "0"	max. 2 V
Max. output current per device	16 A (M12 Power) (for $U_L$ application 9 A) 6 A (M12 Hybrid)
Short-circuit/overload protected	yes/yes
Behavior in case of short circuit or overload	Disconnection with automatic power on
Number of digital outputs	LioN-P 30: max. 8 (Pin 4) LioN-P 60: max. 8 (Pin 4) + 4 (Pin 2)
Status indicator	LED yellow per output
Diagnostic indicator	Red LED per channel

Table 52: IO-Link Master Ports configured as digital outputs

### 11.5.3 Configured as an IO-Link port in COM mode

IO-Link master specification	v1.1, IEC 61131-9
Communication rates	4.8 kbaud (COM 1), 38.4 kbaud (COM 2) and 230.4 kbaud (COM 3)
Line lengths in the IO-Link device	max. 20 m
Number of IO-Link ports (type A/type B)	8
Number of type A ports (X1, X2, X3, X4)	4
Number of type B ports (X5, X6, X7, X8)	4

Table 53: As an IO-link port in COM mode

## 11.6 Digital inputs (X1 – X4, type A ports, Ch. B/Pin 2)

Input connection	Type 1 as per IEC 61131-2
Nominal input voltage	24 V DC
Input current	Typically 3 mA
Channel type	Normally open, p-switching
Number of digital inputs	4
Status indicator	LED white
Diagnostic indicator	Red LED per channel
Port	M12 socket, 5-pin M8 socket, 5-pin

Table 54: Digital inputs (X1 – X4, type A ports, Ch. B/pin 2)



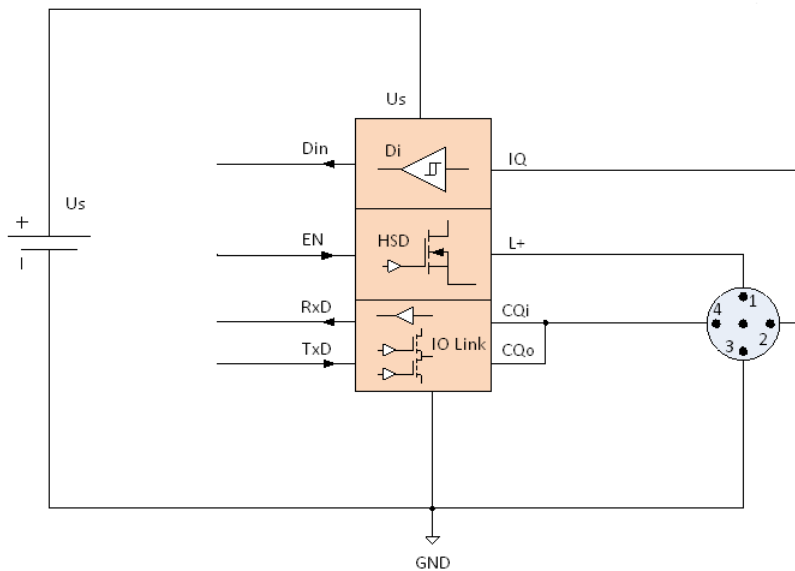

Figure 34: Block diagram Class-A Port

## 11.7 LioN-P 60: $U_{Aux}$ config. as a digital output (X5 - X8, type B ports, Ch. B/Pin 2)

Output type	Normally open, p-switching
Nominal output current per channel Signal status "1" Signal status "0" (0980 ESL 3x9-121)	2 A (for $U_L$ application 1.8 A) max. 2 A max. 1 mA
Nominal output current per channel Signal status "1" Signal status "0" (0980 ESL 3x8-121)	1.6 A max. 1.6 A max. 1 mA
Signal level of the outputs Signal status "1" Signal status "0"	min. ( $U_{Aux} - 1 V$ ) max. 2 V
Max. output current per device	16 A (M12 Power) (for $U_L$ application 9 A) 6 A (M12 Hybrid)
Short-circuit/overload protected	yes/yes
Filter time in case of signal change	0 - 255 ms, default setting 80 ms
Behavior in case of short circuit or overload	Disconnection without automatic power on
Number of digital outputs	4
Status indicator	LED white per output
Diagnostic indicator	Red LED per channel

Table 55: LioN-P 60 digital 2-A outputs (X5 - X8, type B ports, Ch. B/Pin 2)

**11.8 LioN-P 30:  $U_{Aux}$  (X5 - X8)**

Nominal output current per module	max. 4 A
Nominal output current per port	max. 4 A
Short-circuit/overload protected	yes/yes
Status indicator	LED white per output
Diagnostic indicator	Red LED per channel

*Table 56: LioN-P 30 extended sensor supply (X5 - X8) type B ports*

## 11.9 Differences between 0980 ESL 3x8-121 and 0980 ESL 3x9-121

Module type 0980 ESL 3x8-121 contains digital outputs electrically decoupled by series diodes in order to prevent unwanted reverse feeding of the sensor / actuator power supply caused by erroneous wiring.

The following block diagrams illustrate the different module types.

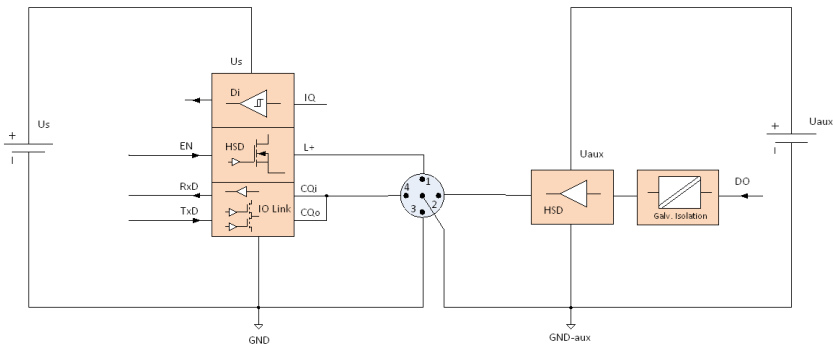

Figure 35: Block diagram Class-B Port, variant 0980 ESL xx9-xxx

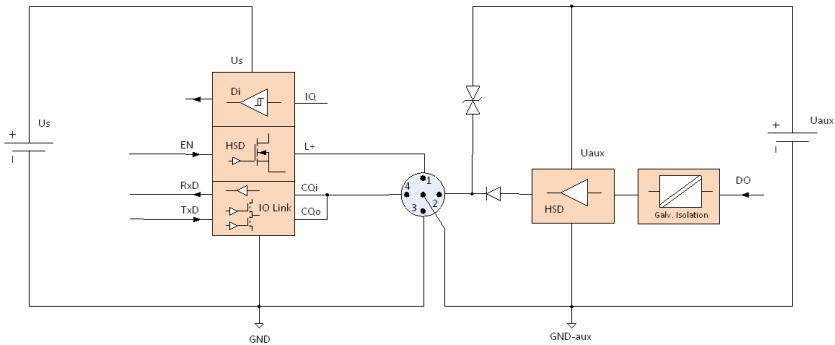

Figure 36: Block diagram Class-B Port, variant 0980 ESL xx8-xxx

## 11.10 LEDs

U <sub>Aux</sub>	Green	Auxiliary sensor/actuator voltage $18\text{ V (+/- 1 V)} < U_{\text{Aux}} < 30\text{ V (+/- 1 V)}$
	Red*	Auxiliary sensor/actuator voltage $U_{\text{Aux}} < 18\text{ V (+/- 1 V)}$ or $U_{\text{Aux}} > 30\text{ V (+/- 1 V)}$ * if "Report U <sub>Aux</sub> supply voltage fault" is enabled.
	off	None of the above conditions
U <sub>S</sub>	Green	System/sensor voltage $18\text{ V (+/- 1 V)} < U_{\text{S}} < 30\text{ V (+/- 1 V)}$
	Red	System/sensor voltage $U_{\text{S}} < 18\text{ V (+/- 1 V)}$ or $U_{\text{S}} > 30\text{ V (+/- 1 V)}$
	off	None of the above conditions
X1 ... X8 A	Green	IO-Link COM Mode: IO-Link communication exists
	Flashing green	IO-Link COM Mode: No IO-Link communication.
	Yellow	Standard-IO Mode: Status of digital input or output on C/Q (pin 4) line "on"
	off	None of the above conditions
X1 ... X8 B	White	Status of digital input on pin 2 line "on"
	Red	IO-Link COM Mode: IO-Link communication error or Overload or short circuit on C/Q (pin 4) line
	Red	All modes: Overload or short circuit on L+ (pin 1) line
	Red	SIO Mode: Overload or short circuit on C/Q (pin 4) line
	off	None of the above conditions
P1 Lnk/ Act P2 Lnk/ Act	Green	Ethernet connection to another subscriber exists. Link detected.
	Flashing yellow	Data exchange with another subscriber.
	off	No connection to another subscriber. No link, no data exchange.
BF	Red	Bus fault. No configuration, no or slow physical connection

	Red flashing at 2 Hz	Link exists but no communication link to the PROFINET controller
	off	PROFINET controller has established an active connection to the device
DIA	Red	PROFINET diagnostic alarm active
	Red flashing at 1 Hz	Watchdog time-out; fail safe mode is active
	Red flashing at 2 Hz, 3 sec	DCP signal service is initiated via the bus
	Red double flash	Firmware update
	off	None of the above conditions

*Table 57: Information on the LED colors*

## **12 Accessories**

In order to get access to various types of accessories, please visit our web page:

<http://www.beldensolutions.com>