



Power Connectors

Industrial Connectivity Solutions



HIRSCHMANN

A **BELDEN** BRAND



lumbergautomation

A **BELDEN** BRAND

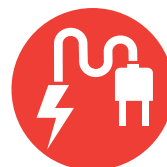

M12 Power Series

G/GO Series

CA Series

7/8" Series

ST Series

M23 Series

Mini Power Series



Be certain.
Belden.



Industrial Connectivity Solutions from Belden

Founded in 1902, Belden's long-term proven solutions are in reliable operation worldwide. Our two leading brands – Hirschmann and Lumberg Automation – combine proven experience with innovation. And a focus on customer needs has made us the global leader in high-quality, end-to-end signal transmissions.

Developed with ease of use in mind, our industrial connectivity solutions are especially designed to stand up to surroundings characterized by dust, water and heavy vibrations.

Whether you want to transfer power, data, signals or all combined in the form of an intelligent I/O system, our diversified product range offers you the right solution for every application.

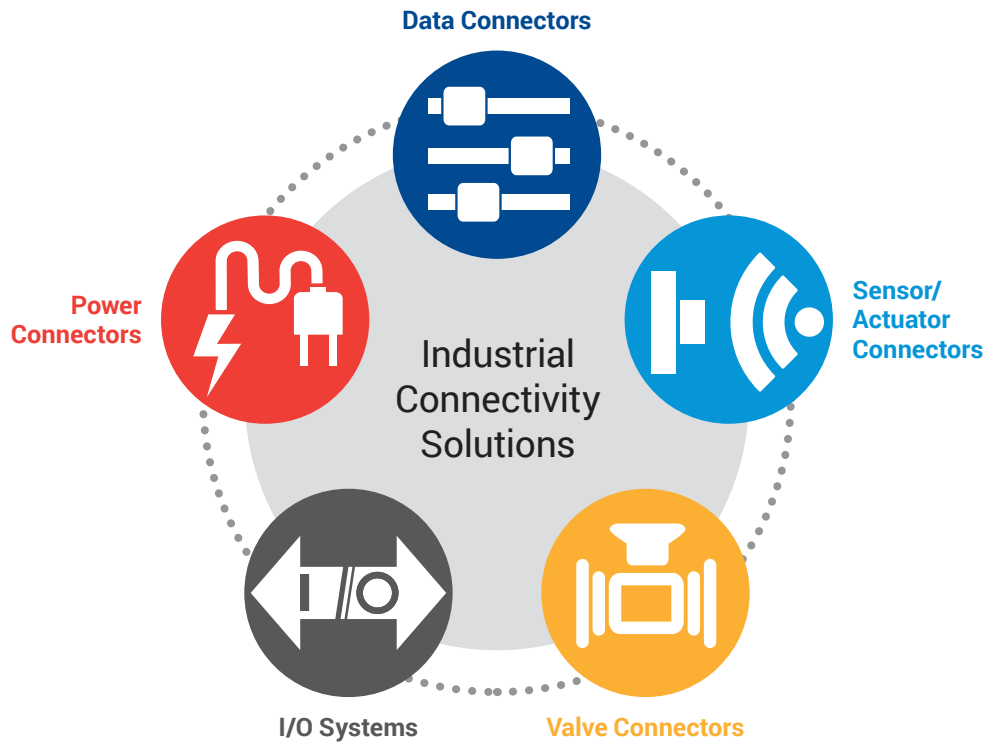



Power Connectors

When it comes to electrical machinery, a reliable and consistent power supply is indispensable. The choice of an appropriate power connector depends on the nature of the application as well as on your specific requirements. Ranging from design diversity to specific standards and high-voltage versions, the Belden Power portfolio offers a broad, practical selection to fulfill your individual application objectives.

Table of Contents

Industrial Connectivity Solutions from Belden	2
Power Connectors	3
Typical Applications.....	4–5
Product Overview	6–7
General Product Information	8–9
• M12 Power Series.....	10–13
• G/GO Series.....	14–17
• CA Series.....	18–21
• 7/8" Series	22–25
• ST Series.....	26–29
• M23 Series.....	30–33
• Mini Power Series.....	34–37
Connectivity Center	38–39

Two Strong Brands for Your Needs



Typical Applications

Miniaturized power connector for lighting applications like floodlights or hall lighting

M12 Power Series T-coding

Long-term proven and developed for Building Automatization such as sun blinds and roller shutters

ST Series

Well-equipped for the power supply in extraordinary harsh and dusty applications, such as industrial drilling machines

G/GO Series

The perfect choice to interconnect machines and controls like HMIs (Human Machine Interfaces)

M23 Series

Power distribution within shop floor surroundings such as control cabinets and machines

Mini Power Series

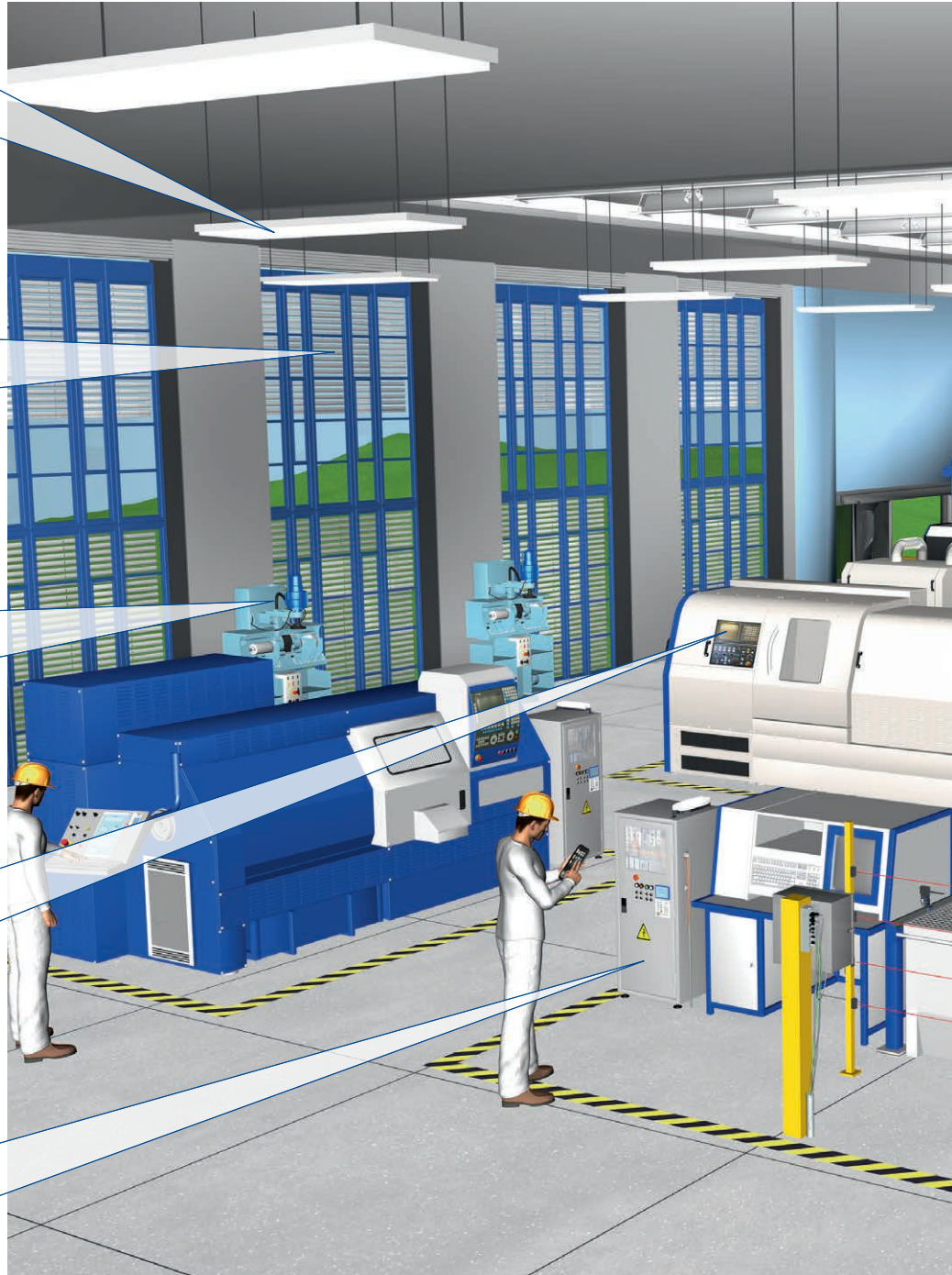



CA Series

Ideal field attachable connector as flexible solution for mobile machinery and conveyor belts

7/8" Series

Reliable power supply for critical applications in industrial environments such as light barrier

M12 Power Series K-coding

Maximum power for rotary current drives also in combination with robotic systems in automated production lines

M12 Power Series S-coding

Smaller connection for high power applications such as frequency converters

M12 Power Series L-coding

Designed and engineered to use in combination with Industrial Ethernet I/O modules

Product Overview

Products					
		M12 Power	G/GO	CA	7/8"
General Data	Pin Assignment	S = 3 + PE / T = 4 K = 4 + PE / L = 4 + FE	2 / 2 + PE / 3 + PE / 4 5 + PE / 6 / 6 + PE / 7	3 + PE / 6 + PE	2 / 2 + PE 4 / 4 + PE
	Max. Operating Voltage	600 V AC/DC	230 V AC/DC	400 V AC/230 V DC	230 V AC/DC 600 V AC/DC*
	Max. Current	16 A	10 A	16 A AC/10 A DC	12 A
	IP-Rating	IP65, IP67, IP69	IP65	IP65, IP67	IP67, IP68 (2h at 10 bar)
Approvals	VDE	●	●	●	
	UL	●		●	●*
	CSA			●	●*
Assembly Design	Molded	●	●		●
	Field Attachable	●	●	●	●
	Receptacle	●	●	●	●
Key Environments	Ruggedized	●	●	●	●
	Mobile Equipment	●	●	●	
	Outdoor		●	●	
	Extreme Climate	●			
	Underwater	●			●
	Household Appliance				
Key Markets	Automotive	●			●
	Machine Building	●	●	●	●
	Transportation	●		●	
	Automation	●	●	●	●
	Infrastructure	●		●	
	Building Automation				
	Material Handling	●	●	●	●

* US version only



Products		ST	M23	Mini Power
General Data	Pin Assignment	2 + PE / 3 + PE 4 + PE / 5 + PE	12 / 11 + PE 19 / 18 + PE	2 + PE / 3 + PE
	Max. Operating Voltage	400 V AC/230 V DC	120 V AC/DC	600 V AC/DC
	Max. Current	16 A AC/10 A DC	8 A	30 A
	IP-Rating	IP54	IP65, IP67	IP67, IP68
Approvals	VDE	●		
	UL	●		●
	CSA			●
Assembly Design	Molded	●	●	●
	Field Attachable	●	●	
	Receptacle	●	●	●
Key Environments	Ruggedized	●		●
	Mobile Equipment		●	
	Outdoor	●		
	Extreme Climate		●	
	Underwater			●
	Household Appliance	●		
Key Markets	Automotive		●	●
	Machine Building	●	●	●
	Transportation			●
	Automation	●	●	●
	Infrastructure		●	
	Building Automation	●		
	Material Handling			●

Cable Overview

Control Cable	Conductor Size	Cable Material	Jacket Color	Temperature Range Stationary	Cable Shielding	Cable Characteristics
001	3G0.75 mm ²	PVC	Orange	-40 °C to +90 °C	No	
002	4X0.5 mm ²	PVC	Orange	-40 °C to +90 °C	No	
003	2X0.75 mm ²	PVC	Orange	-40 °C to +90 °C	No	
004	5G0.5 mm ²	PVC	Orange	-40 °C to +90 °C	No	
242	16G0.5 mm ² /3X1.0 mm ²	PUR	Black	-50 °C to +80 °C	No	
256	8G0.5 mm ² /3X1.0 mm ²	PUR	Black	-50 °C to +80 °C	No	
637	4X18 AWG	TPE	Yellow	-40 °C to +90 °C	No	
678	16 AWG	PVC	Black, White	-40 °C to +105 °C	No	
700	4G1.5 mm ²	PUR	Black	-40 °C to +125 °C	Yes	
703	4G1.5 mm ²	PUR	Black	-40 °C to +125 °C	No	
722	4X1.5 mm ²	PUR	Black	-40 °C to +125 °C	Yes	
723	4X1.5 mm ²	PUR	Black	-40 °C to +125 °C	No	
731	3X18 AWG	TPE	Yellow	-40 °C to +90 °C	No	
733	4G1.5 mm ²	PVC	Black	-40 °C to +90 °C	No	
735	5G1.5 mm ²	PVC	Black	-40 °C to +90 °C	No	
736	5G0.75 mm ²	PVC	Black	-40 °C to +90 °C	No	
794	5X18 AWG	TPE	Yellow	-40 °C to +90 °C	No	
800	3G10 AWG	TPE	Black	-30 °C to +90 °C	No	
802	3G14 AWG	TPE	Black	-30 °C to +90 °C	No	
803	4G10 AWG	TPE	Black	-30 °C to +90 °C	No	
805	4G14 AWG	TPE	Black	-30 °C to +90 °C	No	
838	3X16 AWG	TPE	Yellow	-40 °C to +90 °C	No	
839	4X16 AWG	TPE	Yellow	-40 °C to +90 °C	No	
877	5X16 AWG	TPE	Yellow	-40 °C to +90 °C	No	
910	5G1.5 mm ²	PUR	Black	-40 °C to +125 °C	Yes	
911	5G1.5 mm ²	PUR	Black	-40 °C to +125 °C	No	
912	5G2.5 mm ²	PUR	Black	-40 °C to +125 °C	No	
915	4G1.5 mm ²	PVC	Black	-30 °C to +80 °C	Yes	
916	5G1.5 mm ²	PVC	Black	-30 °C to +80 °C	Yes	
921	5G2.5 mm ²	PUR	Black	-30 °C to +125 °C	Yes	
949	5G1.5 mm ²	PUR	Grey	-40 °C to +125 °C	No	
950	5G2.5 mm ²	PUR	Grey	-40 °C to +125 °C	No	
956	5G1.5 mm ²	PUR	Grey	-40 °C to +125 °C	Yes	
957	5G2.5 mm ²	PUR	Grey	-40 °C to +125 °C	Yes	
ST	3G0.75 mm ²	H05RR	Black	-30 °C to +60 °C	No	
ST	4G0.75 mm ²	H05RR	Black	-30 °C to +60 °C	No	
ST	5G0.75 mm ²	H05RR	Black	-30 °C to +60 °C	No	
G	2X0.75 mm ²	H05RN	Black	-25 °C to +70 °C	No	
G	3G1.0 mm ²	PVC	Grey	-25 °C to +70 °C	No	
G	4G0.75 mm ²	PVC	Grey	-25 °C to +70 °C	No	
G	4X1.0 mm ²	PVC	Grey	-25 °C to +70 °C	No	

Vibration and shock resistance
 UL-approved
 UV resistance
 Oil, coolants, lubricants and emulsion resistance
 Drag chain suitability
 Electromagnetic resistance



Cable Material Comparison

Material	High Temp	Low Temp	Flexibility	UV-Rays	Chemicals	Oil
PUR	●●●●	●●●○	●●●○	●●●○	●●●●	●●●○
PVC	●●○○	●●○○	●●○○	●●○○	●●●○	●●○○
TPE	●●●○	●●●●	●●●●	●●○○	●●○○	●●●○

●○○○ = Poor ●●○○ = Fair ●●●○ = Good ●●●● = Excellent

Please request datasheet for more detailed information

IP Code

Index		Degree of Protection
0		No protection against accidental contact, no protection against solid foreign bodies
1		Protection against contact with any large area by hand and against solid foreign bodies with $\varnothing > 50$ mm
2		Protection against contact with the fingers, protection against solid foreign bodies with $\varnothing > 12$ mm
3		Protection against tools, wires or similar objects with $\varnothing > 2.5$ mm, protection against solid foreign bodies with $\varnothing > 2.5$ mm
4		Just like 3 except for the size difference of $\varnothing > 1$ mm
5		Full protection against contact, protection against interior injurious dust deposits
6		Total protection against contact, protection against penetration of dust

Index		Degree of Protection
0		No protection against water
1		Protection against vertical water drops
2		Protection against water drops (up to a 15° angle)
3		Protection against diagonal water drops (up to a 60° angle)
4		Protection against splashed water from all directions
5		Protection against water (out of a nozzle) from all directions
6		Protection against water penetration during temporary flooding
7		Protection against temporary submersion in water
8		Protection against permanent submersion in water
9K		Protected against water from high-pressure/steam jet cleaners

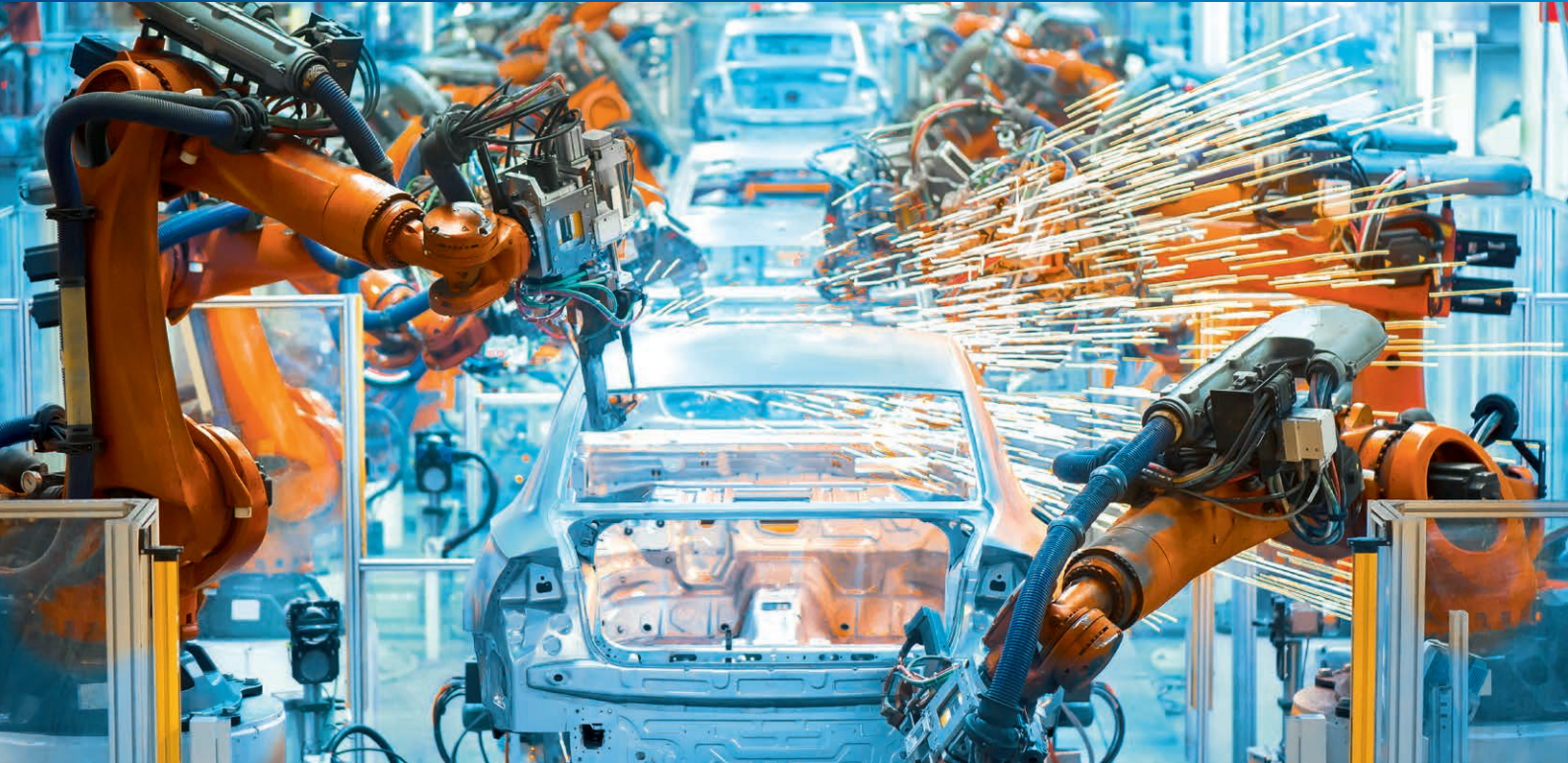

Circular Connectors M12 Power Series

When only the Best is Good Enough – World's Strongest M12 Connector

The M12 Power Series opens the world of conventional M12 technology to high-power transmission. Carrying 16 A at 630 V it is your answer to the increasing demand for powerful connectivity in the smallest possible housings.



The Benefits

Ready for any challenge – full power in hot, wet, particularly dusty or even moving applications





Performance you can rely on – thanks to high-class material and various international approvals

Comprehensive portfolio – four different codings to fulfill the need of almost every application

Markets

- Machine building
- Automation
- Automotive
- Material handling
- Infrastructure
- Transportation

Technical Information

M12 Power Series	4-pole S-coding	5-pole L-coding	5-pole K-coding	4-pole T-coding
				
General Data				
No. of Pins	4 (3 + PE)	5 (4 + FE)	5 (4 + PE)	4
Cable-Gland (field attachable)	PG 11	PG 11	PG 11	PG 11
Cable-Range (field attachable)	ø 3.0 mm to 11.0 mm	ø 3.0 mm to 11.0 mm	ø 3.0 mm to 11.0 mm	ø 3.0 mm to 11.0 mm
Terminal Type (field attachable)	Screw	Crimp	Crimp	Screw
Conductor Size (field attachable)	0.5 mm ² to 1.5 mm ²	0.75 mm ² , 1.5 mm ² , 2.5 mm ²	0.75 mm ² , 1.5 mm ² , 2.5 mm ²	0.5 mm ² to 1.5 mm ²
Cable Material (molded)	PUR, PVC	PUR	PUR, PVC	PUR
Conductor Size (molded)	1.5 mm ²	1.5 mm ² , 2.5 mm ²	0.75 mm ² , 1.5 mm ² , 2.5 mm ²	1.5 mm ²
Housing Color	Blue, Black	Blue, Black	Blue, Black	Blue, Black
Electrical Data				
Operating Voltage	600 V AC/DC	50 V AC/60 V DC	600 V AC/DC	50 V AC/60 V DC
Current	16 A AC/DC	16 A AC/DC	16 A AC/DC	16 A AC/DC
Environmental Data				
Ambient Temperature*	-40 °C to +125 °C	-40 °C to +125 °C	-40 °C to +125 °C	-40 °C to +125 °C
Protection Degree	IP65, IP67, IP69	IP65, IP67, IP69	IP65, IP67, IP69	IP65, IP67, IP69
Approvals	VDE, UL	VDE, UL	VDE, UL	VDE, UL

* Notice derating and cable temperature





Product Configurator

Cordsets

R S T S **5 K** - **7 3 5** / **5 M**

Gender & Design

- RST** = Male cordset, molded, straight
- RSWT** = Male cordset, molded, 90° angled
- RKT** = Female cordset, molded, straight
- RKWT** = Female cordset, molded, 90° angled

Shielding

- S** = 360° shielding = No shielding

Coding & Pin Assignment

- 5K** = K-coding, 5-pole (4+PE) **4S** = S-coding, 4-pole (3+PE)
- 5L** = L-coding, 5-pole (4+FE) **4T** = T-coding, 4-pole

Cable Style

S-coding

- 733** = 4G1.5 mm², PVC, Black
- 703** = 4G1.5 mm², PUR, Black
- 915** = 4G1.5 mm², shielded, PVC, Black
- 700** = 4G1.5 mm², shielded, PUR, Black

L-coding

- 949** = 5G1.5 mm², PUR, Grey
- 950** = 5G2.5 mm², PUR, Grey
- 956** = 5G1.5 mm², shielded, PUR, Grey
- 957** = 5G2.5 mm², shielded, PUR, Grey

K-coding

- 736** = 5G0.75 mm², PVC, Black
- 735** = 5G1.5 mm², PVC, Black
- 912** = 5G2.5 mm², PVC, Black
- 911** = 5G1.5 mm², PUR, Black
- 916** = 5G1.5 mm², shielded, PVC, Black
- 921** = 5G2.5 mm², shielded, PVC, Black
- 910** = 5G1.5 mm², shielded, PUR, Black

T-coding

- 722** = 4X1.5 mm², shielded, PUR, Black
- 723** = 4X1.5 mm², PUR, Black

- X: Without PE
- G: With PE

Other cable styles available upon request.
Please contact: icos-sales@belden.com

Cable Length

- 2M** = 2 meter
- 5M** = 5 meter
- 10M** = 10 meter

Other cable lengths available upon request.
Please contact: icos-sales@belden.com

Field Attachables

R K C C S **5 K** / **1 1** **1 , 5**

Gender & Design

L- & K-coding (crimp type)

- RSCC** = Male connector, field attachable, straight
- RKCC** = Female connector, field attachable, straight

S- & T-coding (screw type)

- RSC** = Male connector, field attachable, straight
- RKC** = Female connector, field attachable, straight

Shielding

- S** = 360° shielding (not optional)

Coding & Pin Assignment

- 5K** = K-coding, 5-pole (4 + PE) **4S** = S-coding, 4-pole (3 + PE)
- 5L** = L-coding, 5-pole (4 + FE) **4T** = T-coding, 4-pole

Cable Gland

- 11** = PG11

Cross-section

- 0,75** = 0.75 mm² crimp-contact (L- & K-coding)
- 1,5** = 1.5 mm² crimp-contact (L- & K-coding)
- = 0.5 to 1.5 mm² (S- & T-coding with screw terminal)



Order Overview

M12 Power Series	S-coded 4-pole (3 + PE)		L-coded 5-pole (4 + FE)	
	Male	Female	Male	Female
<p>1. Choose Coding →</p> <p>2. Choose Design ↓</p>				
Field Attachables				
Straight, screw type, shielded/unshielded	RSCS 4S/11	RKCS 4S/11	–	–
Straight, crimp type, shielded/unshielded	–	–	RSCCS 5L/11,1.5	RKCCS 5L/11,1.5
Receptacles				
Front mount	RSF6S 4S-033/0,2 M	RKF6S 4S-033/0,2 M	RSF6S 5L-033/0,2 M	RKF6S 5L-033/0,2 M
Front mount (positionable)	RSP6S 4S-033/0,2 M	RKP6S 4S-033/0,2 M	RSP6S 5L-033/0,2 M	RKP6S 5L-033/0,2 M
Rear mount	RSH6S 4S-033/0,2 M	RKH6S 4S-033/0,2 M	RSH6S 5L-033/0,2 M	RKH6S 5L-033/0,2 M
Flange (20x20)	RSA0S 4S-033/0,2 M	–	RSA0S 5L-033/0,2 M	–
Single-Ended Cordsets				
Straight, unshielded	RST 4S-703/*M	RKT 4S-703/*M	RST 5L-949/*M	RKT 5L-949/*M
Straight, shielded	RSTS 4S-700/*M	RKTS 4S-700/*M	RSTS 5L-956/*M	RKTS 5L-956/*M
Angled, unshielded	RSWT 4S-703/*M	RKWT 4S-703/*M	RSWT 5L-949/*M	RKWT 5L-949/*M
Double-Ended Cordsets				
Straight-to-straight, unshielded	RST 4S-RKT 4S-703/*M		RST 5L-RKT 5L-949/*M	
Straight-to-straight, shielded	RSTS 4S-RKTS 4S-700/*M		RSTS 5L-RKTS 5L-956/*M	
Straight-to-angled, unshielded	RST 4S-RKWT 4S-703/*M		RST 5L-RKWT 5L-949/*M	
Angled-to-angled, unshielded	RSWT 4S-RKWT 4S-703/*M		RSWT 5L-RKWT 5L-949/*M	
M12 Power Series	K-coded 5-pole (4 + PE)		T-coded 4-pole	
	Male	Female	Male	Female
<p>1. Choose Coding →</p> <p>2. Choose Design ↓</p>				
Field Attachables				
Straight, screw type, shielded/unshielded	–	–	RSCS 4T/11	RKCS 4T/11
Straight, crimp type, shielded/unshielded	RSCCS 5K/11,1.5	RKCCS 5K/11,1.5	–	–
Receptacles				
Front mount	RSF6S 5K-033/0,2 M	RKF6S 5K-033/0,2 M	RSF6U 4T-033/0,2 M	RKF6U 4T-033/0,2 M
Front mount (positionable)	RSP6S 5K-033/0,2 M	RKP6S 5K-033/0,2 M	RSP6U 4T-033/0,2 M	RKP6U 4T-033/0,2 M
Rear mount	RSH6S 5K-033/0,2 M	RKH6S 5K-033/0,2 M	RSH6U 4T-033/0,2 M	RKH6U 4T-033/0,2 M
Flange (20x20)	RSA0S 5K-033/0,2 M	–	RSA0U 4T-033/0,2 M	–
Single-Ended Cordsets				
Straight, unshielded	RST 5K-911/*M	RKT 5K-911/*M	RST 4T-723/*M	RKT 4T-723/*M
Straight, shielded	RSTS 5K-910/*M	RKTS 5K-910/*M	RSTS 4T-722/*M	RKTS 4T-722/*M
Angled, unshielded	RSWT 5K-911/*M	RKWT 5K-911/*M	RSWT 4T-723/*M	RKWT 4T-723/*M
Double-Ended Cordsets				
Straight-to-straight, unshielded	RST 5K-RKT 5K-911/*M		RST 4T-RKT 4T-723/*M	
Straight-to-straight, shielded	RSTS 5K-RKTS 5K-910/*M		RSTS 4T-RKTS 4T-722/*M	
Straight-to-angled, unshielded	RST 5K-RKWT 5K-911/*M		RST 4T-RKWT 4T-723/*M	
Angled-to-angled, unshielded	RSWT 5K-RKWT 5K-911/*M		RSWT 4T-RKWT 4T-723/*M	

Blue highlighted product features are available in different variants. Please see page 12 for more information.



Rectangular Connectors G/GO Series

The Space-Saver: Great in Performance – Small in Size

Where other connectors may find conditions too tight, the G/GO Series is right at home – and that’s why the rectangular connector with its compact dimensions plays a major role in the world of miniaturization.



The Benefits

Extremely tough – especially designed for applications with persistent mechanical stress, e.g. in underground mining surroundings

Flexible to use – viable for a wide range of industries due to various pin assignments









Flexible to fit – square (G) and rectangular designs (GO) to match your individual application

Markets

- Machine building
- Automation
- Material handling
- Underground mining



Technical Information

G/GO Series	G Series 2-pole	G Series 3-pole	G Series 4-pole	GO Series 6-pole	GO Series 7-pole
					
 General Data					
No. of Pins	2	2 + PE	Molded: 3 + PE, 4 Field attachable: 4 Receptacle: 4	5 + PE, 6	6 + PE, 7
Cable-Gland (field attachable)	–	PG 7	PG 7	PG 7	PG 11
Cable-Range (field attachable)	–	ø 4.5 mm to 7.5 mm	ø 4.5 mm to 6.0 mm	ø 4.0 mm to 7.5 mm	ø 4.0 mm to 10.0 mm
Terminal Type (field attachable)	–	Solder	Solder	Solder	Screw
Conductor Size (field attachable)	–	0.15 mm ² to 0.5 mm ²	0.15 mm ² to 0.5 mm ²	0.15 mm ² to 0.5 mm ²	0.25 mm ² to 1.0 mm ²
Cable Material (molded)	PVC	PVC	PVC	–	–
Conductor Size (molded)	0.75 mm ²	1.0 mm ²	0.75 mm ² , 1.0 mm ²	–	–
Housing Color	Black, Grey	Black, Grey	Black, Grey	Black	Black
 Electrical Data					
Operating Voltage	50 V AC/DC	230 V AC/DC	3 + PE: 230 V AC/DC 4: 50 V AC/DC	5 + PE: 230 V AC/DC 6: 50 V AC/DC	6 + PE: 230 V AC/DC 7: 50 V AC/DC
Current	10 A AC/DC	Molded: 10 A AC/DC Field attachable: 6 A AC/DC	Molded: 10 A AC/DC Field attachable: 6 A AC/DC Receptacle: 10 A AC/DC	6 A AC/DC	10 A AC 6 A DC
 Environmental Data					
Ambient Temperature*	-40 °C to +90 °C	-40 °C to +90 °C	-40 °C to +90 °C	-40 °C to +90 °C	-40 °C to +90 °C
Protection Degree	IP65	IP65	IP65	IP65	IP65
Approvals	VDE	VDE	VDE	VDE	VDE

* Notice derating and cable temperature





Product Configurator

G Series Cordsets und Field Attachables

G **3 0** **K W** **3** **F** **2 M** **GREY**

Series Indicator

G = G Series

Pin Assignment

- 2 = 2-pole (molded only)
- 20 = 3-pole (2 + PE)
- 30** = 4-pole (3 + PE)
- 4 = 4-pole

Geometry Design

- KW** = Molded, 90° angled
- W = Field attachable, 90° angled

Protective Earth

- 1 = Without earth conductor
- 3** = With earth conductor

Gender

- M = Male connector
- F** = Female connector

Cable Length

- = Cordless (field attachable)
 - 1,5M = 1.5 meter
 - 2M** = 2 meter
 - 3M = 3 meter
- Other cable lengths available upon request.
Please contact: icos-sales@belden.com

Housing Color

- GREY** = Grey housing
- BLACK = Black housing

GO Series Field Attachables and Receptacles

G O **0 7 0** **W F**

Series Indicator

GO = GO Series (long edition 5-, 6- and 7-pole)

Pin Assignment

- 51 = 6-pole (5 + PE/230 V)
- 6 = 6-pole (50 V)
- 60 = 6-pole (230 V)
- 610 = 7-pole (6 + PE/230 V)
- 070** = 7-pole (50 V)
- 700 = 7-pole (230 V)

Geometry Design

- WF** = 90° angled, female, (field attachable)
- UM = Male, PCB mount, (receptacle)
- FAV M = Male, octagonal flange, (receptacle)
- FA M = Male, rectangular flange, (receptacle)

Order Overview

G Series	2-pole		3-pole (2 + PE)	
	Male	Female	Male	Female
<p>1. Choose Coding →</p> <p>↓ 2. Choose Design</p>				
Field Attachables				
G Series, angled, solder type	-	-	-	G 20 W 3 F Grey
Receptacles				
G Series, solder type	-	-	-	-
Single-Ended Cordsets				
G Series, angled	-	G 2 KW 1 F *M Grey	G 20 KW 3 M *M Grey	G 20 KW 3 F *M Grey
G Series	4-pole (3 + PE)		4-pole	
	Male	Female	Male	Female
<p>1. Choose Coding →</p> <p>↓ 2. Choose Design</p>				
Field Attachables				
G Series, angled, solder type	-	G 30 W 3 F Grey	-	G 4 W 1 F Grey
Receptacles				
G Series, solder type	G 30 A 3 M Grey	G 30 E 3 F Grey	G 4 A 1 M Grey	-
Single-Ended Cordsets				
G Series, angled	G 30 KW 3 M *M Grey	G 30 KW 3 F *M Grey	-	G 4 KW 1 F *M Grey
GO Series	6-pole (5 + PE)		6-pole	
	Male	Female	Male	Female
<p>1. Choose Coding →</p> <p>↓ 2. Choose Design</p>				
Field Attachables				
GO Series, angled, solder type	-	GO 51 WF Black	-	GO 6 WF Black (50 V) GO 6 WF Black (230 V)
GO Series, angled, screw type	-	-	-	-
Receptacles				
GO Series, solder type	GO 51 UM	-	GO 6 UM (50 V) GO 60 UM (230 V)	-
GO Series, solder type with flange	GO 51 FAV M	-	GO 6 FAV M (50 V) GO 60 FAV M (230 V)	-
GO Series	7-pole (6 + PE)		7-pole	
	Male	Female	Male	Female
<p>1. Choose Coding →</p> <p>↓ 2. Choose Design</p>				
Field Attachables				
GO Series, angled, solder type	-	-	-	-
GO Series, angled, screw type	-	GO 610 WF Black	-	GO 070 WF Black (50 V) GO 700 WF Black (230 V)
Receptacles				
GO Series, solder type	-	-	-	-
GO Series, solder type with flange	GO 610 FA M	-	GO 070 FA M (50 V) GO 700 FA M (230V)	-

Blue highlighted product features are available in different variants. Please see page 16 for more information.



Circular Connectors CA Series

Reliable Power Transmission – where you need it,
when you need it

Combining the advantages of a lightweight plastic housing with the mechanical robustness of an industrial connector, the CA Series represents a reliable solution for the most demanding applications.



The Benefits

Ruggedized for performance – well-proven power supply for wet, dusty and harsh surroundings

Intuitive to handle – thanks to user-friendly termination and assembly in a jiffy

Versatile to use – technologically convincing connectivity solution for a wide range of applications

Markets

- Machine building
- Measurement and control
- Automation
- Logistics
- Infrastructure
- Material handling

Technical Information

CA Series	4-pole (3 + PE)	7-pole (6 + PE)
		
 General Data		
No. of Pins	3 + PE	6 + PE
Cable-Gland (field attachable)	TR 22	TR 22
Cable-Range (field attachable)	ø 6 mm to 12 mm	ø 6 mm to 12 mm
Terminal Type (field attachable)	Screw	Solder
Conductor Size (field attachable)	0.5 mm ² to 2.5 mm ²	max. 0.75 mm ²
Cable Material (molded)	-	-
Conductor Size (molded)	-	-
Housing/Contact Holder Color	Black, White, Red, Blue	Black, White, Red, Blue
 Electrical Data		
Operating Voltage	400 V AC/230 V DC	230 V AC/DC
Current	16 A AC/10 A DC	10 A AC/DC
 Environmental Data		
Ambient Temperature*	-40 °C to +90 °C	-40 °C to +90 °C
Protection Degree	IP65, IP67	IP65, IP67
Approvals	UL, VDE, CSA	UL, VDE, CSA

* Notice derating and cable temperature



Product Configurator

Field Attachables and Receptacles

Series Indicator

CA = CA Series

Pin Assignment

3 = 4-pole (3 + PE)

6 = 7-pole (6 + PE)

Geometry Design

□ = Straight

W = 90° angled

Gender & Design

LS = Male connector, field attachable

LD = Female connector, field attachable

GS = Male connector, receptacle with flange

GD = Female connector, receptacle with flange

Housing / Contact Holder Color

BLACK = Black housing

BLUE = Blue housing

RED = Red housing

WHITE = White housing

C A **3** **W** **L S** **B L U E**

CA Series – intuitive assembly in a jiffy

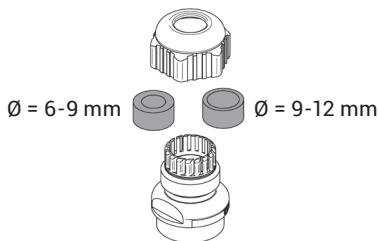

Pick the right sealing depending on your cable size.

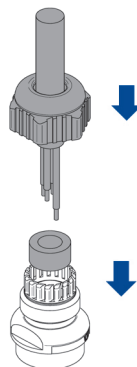

Insert the sealing into the body, then push the cable through.

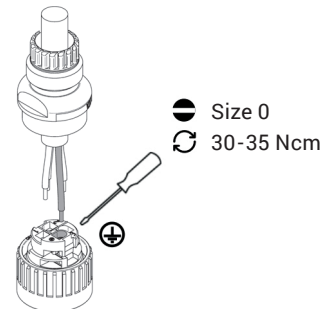

Unscrew the PE-contact, insert the PE-conductor and tighten again.

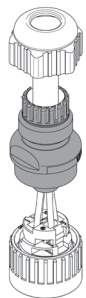

Repeat this procedure for the remaining contacts.

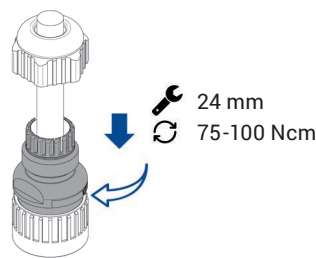



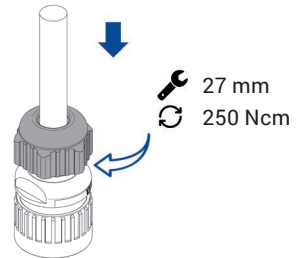

Screw the connector body to the contact holder.



Screw the cable gland to the connector body.

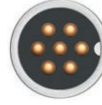

Order Overview

CA Series	4-pole (3 + PE)		7-pole (6 + PE)	
	Male	Female	Male	Female
1. Choose Coding →				
2. Choose Design ↓				
Field Attachables				
Straight, screw type	CA 3 LS	CA 3 LD	–	–
Straight, solder type	–	–	CA 6 LS	CA 6 LD
Angled, screw type	CA 3 W LS	CA 3 W LD	–	–
Angled, solder type	–	–	CA 6 W LS	CA 6 W LD
Receptacles				
Screw type	CA 3 GS	CA 3 GD	–	–
Solder type	–	–	CA 6 GS	CA 6 GD
Accessories				
Safety cap for field attachables, variable loop	CA 00 SD 1	CA 00 SD 3	CA 00 SD 1	CA 00 SD 3
Safety cap for receptacles, fixed loop	CA 00 SD 2	CA 00 SD 4	CA 00 SD 2	CA 00 SD 4

Please see page 20 for more information.





Circular Connectors 7/8" Series

Sealed like a submarine – completely watertight up to 100 meters

The circular connectors of the 7/8" Series feature very high mechanical and electrical durability. A special PUR-overmolding prevents dust and moisture from entering the connector and ensures impermeability up to 10 bar.



The Benefits

Feel the difference – high-quality material ensuring a long lifetime and exceptional operational reliability







Great variety – a wide range of versions offers flexible connection solutions

Worldwide valued – internationally standardized interface for global usage

Markets

- Machine building
- Automation
- Material handling
- Automotive

Technical Information

7/8" Series	2-pole	3-pole (2 + PE)	4-pole	5-pole (4 + PE)
				
 General Data				
No. of Pins	2	2 + PE	Molded: 4-pole Field attachable: 3 + PE Receptacle: 4-pole	4 + PE
Cable-Gland (field attachable)	–	PG 9, 11, 13.5, 16	PG 9, 11, 13.5, 16	PG 9, 11, 13.5, 16
Cable-Range (field attachable)	–	PG 9: ø 6.0 mm to 8.0 mm PG 11: ø 8.0 mm to 10.0 mm PG 13.5: ø 10.0 mm to 12.0 mm PG 16: ø 12.0 mm to 14.0 mm	PG 9: ø 6.0 mm to 8.0 mm PG 11: ø 8.0 mm to 10.0 mm PG 13.5: ø 10.0 mm to 12.0 mm PG 16: ø 12.0 mm to 14.0 mm	PG 9: ø 6.0 mm to 8.0 mm PG 11: ø 8.0 mm to 10.0 mm PG 13.5: ø 10.0 mm to 12.0 mm PG 16: ø 12.0 mm to 14.0 mm
Terminal Type (field attachable)	–	Screw	Screw	Screw
Conductor Size (field attachable)	–	max. 1.5 mm ²	max. 1.5 mm ²	max. 1.5 mm ²
Cable Material (molded)	PVC	PVC	PVC	PVC
Conductor Size (molded)	0.75 mm ²	0.75 mm ²	0.5 mm ²	0.5 mm ²
Housing Color	Orange, Yellow**	Molded: Orange, Yellow** Field attachable: Black	Molded: Orange, Yellow** Field attachable: Black	Molded: Orange, Yellow** Field attachable: Black
 Electrical Data				
Operating Voltage	230 V AC/DC 600 V AC/DC**	230 V AC/DC 600 V AC/DC**	230 V AC/DC 600 V AC/DC**	230 V AC/DC 600 V AC/DC**
Current	12 A AC/DC	12 A AC/DC	9 A AC/DC	9 A AC/DC
 Environmental Data				
Ambient Temperature*	-40 °C to +90 °C	-40 °C to +90 °C	-40 °C to +90 °C	-40 °C to +90 °C
Protection Degree	Molded: IP68 (2h, 10 bar) Field attachable: IP67 Receptacle: IP68 (1h, 10 bar)	Molded: IP68 (2h, 10 bar) Field attachable: IP67 Receptacle: IP68 (1h, 10 bar)	Molded: IP68 (2h, 10 bar) Field attachable: IP67 Receptacle: IP68 (1h, 10 bar)	Molded: IP68 (2h, 10 bar) Field attachable: IP67 Receptacle: IP68 (1h, 10 bar)
Approvals	–	–	–	–

* Notice derating and cable temperature

** US version only





Product Configurator

Cordsets

R K **2 0** - **0 3** / **2 M**

Gender & Design

- RS = Male cordset, molded, straight
- RSW = Male cordset, molded, 90° angled
- RK** = Female cordset, molded, straight
- RKW = Female cordset, molded, 90° angled

Pin Assignment

- 20** = 2-pole, male coupling nut with external threads
- 30** = 3-pole (2 + PE), male coupling nut with external threads
- 40** = 4-pole, male coupling nut with external threads
- 50** = 5-pole (4 + PE), male coupling nut with external threads

US Version

- 301 = 3-pole (2 + PE), male coupling nut with internal threads
- 401 = 4-pole, male coupling nut with internal threads
- 501 = 5-pole (4 + PE), male coupling nut with internal threads

Cable Style

- | | |
|---|--|
| 01 = 3G0.75 mm ² , PVC, Orange | 03 = 2X0.75 mm ² , PVC, orange |
| 02 = 4X0.5 mm ² , PVC, Orange | 04 = 5G0.5 mm ² , PVC, orange |

US Version

- | | |
|------------------------------------|------------------------------------|
| 2-pole | 3-pole |
| 678 = 2X16 AWG, PVC, Yellow, STOW | 731 = 3X18 AWG, TPE, Yellow, PLTC |
| | 838 = 3X16 AWG, TPE, Yellow, TC-ER |
| 4-pole | 5-pole |
| 637 = 4X18 AWG, TPE, Yellow, PLTC | 794 = 5X18 AWG, TPE, Yellow, PLTC |
| 839 = 4X16 AWG, TPE, Yellow, TC-ER | 877 = 5X16 AWG, TPE, Yellow, TC-ER |

X: Without PE Other cable styles available upon request.
G: With PE Please contact: icos-sales@belden.com

Cable Length

- 2M** = 2 meter
 - 5M = 5 meter
 - 10M = 10 meter
- Other cable lengths available upon request.
Please contact: icos-sales@belden.com

Field Attachables

R K C **3 0** / **9**

Gender & Design

- RSC = Male connector, field attachable, straight
- RKC** = Female connector, field attachable, straight

Pin Assignment

- 30** = 3-pole (2 + PE), male coupling nut with external threads
- 40** = 4-pole (3 + PE), male coupling nut with external threads
- 50** = 5-pole (4 + PE), male coupling nut with external threads

US Version

- 301 = 3-pole (2 + PE), male coupling nut with internal threads
- 401 = 4-pole, male coupling nut with internal threads
- 501 = 5-pole (4 + PE), male coupling nut with internal threads

Cable Gland

- 9** = PG 9
- 11 = PG 11
- 13,5 = PG 13.5
- 16 = PG 16



Order Overview

7/8" Series	2-pole		3-pole (2 + PE)	
	Male	Female	Male	Female
<p>1. Choose Coding →</p> <p>2. Choose Design ↓</p>				
Field Attachables				
Straight, screw type, PG 9, external threads	-	-	RSC 30/9	RKC 30/9
Straight, screw type, PG 11, external threads	-	-	RSC 30/11	RKC 30/11
Straight, screw type, PG 13.5, external threads	-	-	RSC 30/13,5	RKC 30/13,5
Straight, screw type, PG 16, external threads	-	-	RSC 30/16	RKC 30/16
Straight, screw type, PG 9, internal threads	-	-	RSC 301/9	-
Straight, screw type, PG 11, internal threads	-	-	RSC 301/11	-
Straight, screw type, PG 13.5, internal threads	-	-	RSC 301/13,5	-
Straight, screw type, PG 16, internal threads	-	-	RSC 301/16	-
Receptacles				
Front mount, with stranded wire, PG 11	RSF 20/11-03	RKF 20/11-03	RSF 30/11-01	RKF 30/11-01
Front mount, with stranded wire, PG 13.5	RSF 20/13,5-03	RKF 20/13,5-03	RSF 30/13,5-01	RKF 30/13,5-01
Single-Ended Cordsets				
Straight, external threads	RS 20-03/*M	RK 20-03/*M	RS 30-01/*M	RK 30-01/*M
Angled, external threads	RSW 20-03/*M	RKW 20-03/*M	RSW 30-01/*M	RKW 30-01/*M
Straight, internal threads	-	-	RS 301-01/*M	RK 301-01/*M
Angled, internal threads	-	-	RSW 301-01/*M	RKW 301-01/*M
Double-Ended Cordsets				
Straight-to-straight, external threads	RSRK 20-03/* M		RSRK 30-01/* M	
Straight-to-angled, external threads	RSRKW 20-03/* M		RSRKW 30-01/* M	
Angled-to-angled, external threads	RSWRKW 20-03/* M		RSWRKW 30-01/* M	
7/8" Series	4-pole (3 + PE)		5-pole (4 + PE)	
	Male	Female	Male	Female
<p>1. Choose Coding →</p> <p>2. Choose Design ↓</p>				
Field Attachables				
Straight, screw type, PG 9, external threads	RSC 40/9	RKC 40/9	RSC 50/9	RKC 50/9
Straight, screw type, PG 11, external threads	RSC 40/11	RKC 40/11	RSC 50/11	RKC 50/11
Straight, screw type, PG 13.5, external threads	RSC 40/13,5	RKC 40/13,5	RSC 50/13,5	RKC 50/13,5
Straight, screw type, PG 16, external threads	RSC 40/16	RKC 40/16	RSC 50/16	RKC 50/16
Straight, screw type, PG 9, internal threads	RSC 401/9	-	RSC 501/9	-
Straight, screw type, PG 11, internal threads	RSC 401/11	-	RSC 501/11	-
Straight, screw type, PG 13.5, internal threads	RSC 401/13,5	-	RSC 501/13,5	-
Straight, screw type, PG 16, internal threads	RSC 401/16	-	RSC 501/16	-
Receptacles				
Front mount, with stranded wire, PG 11	RSF 40/11-02	RKF 40/11-02	RSF 50/11-04	RKF 50/11-04
Front mount, with stranded wire, PG 13.5	RSF 40/13,5-02	RKF 40/13,5-02	RSF 50/13,5-04	RKF 50/13,5-04
Single-Ended Cordsets				
Straight, external threads	RS 40-02/*M	RK 40-02/*M	RS 50-04/*M	RK 50-04/*M
Angled, external threads	RSW 40-02/*M	RKW 40-02/*M	RSW 50-04/*M	RKW 50-04/*M
Straight, internal threads	RS 401-02/*M	RK 401-02/*M	RS 501-04/*M	RK 501-04/*M
Angled, internal threads	RSW 401-02/*M	RKW 401-02/*M	RSW 501-04/*M	RKW 501-04/*M
Double-Ended Cordsets				
Straight-to-straight, external threads	RSRK 40-02/* M		RSRK 50-04/* M	
Straight-to-angled, external threads	RSRKW 40-02/* M		RSRKW 50-04/* M	
Angled-to-angled, external threads	RSWRKW 40-02/* M		RSWRKW 50-04/* M	

Blue highlighted product features are available in different variants. Please see page 24 for more information.



Rectangular Connectors ST Series

Rely on the original – market leading for decades

Conforming to IEC 60335, the latest standards for household appliances, the ST Series sets the standard in building automation applications. This makes it an ideal first choice for sun shades and roller blind systems.

The Benefits

Prepared for any weather – especially designed to withstand the challenges of outdoor usages, e.g. rain, ozone and UV radiation

Easy to connect – low installation efforts lead to more ease of use and an efficient work flow

Easy to rely on – ideally suited for ruggedized, moving applications where vibrations and dust are commonplace





Markets

- Building automation
- Machine building
- Automation





Technical Information

ST Series	3-pole (2 + PE)	4-pole (3 + PE)	5-pole (4 + PE)	6-pole (5 + PE)
				
 General Data				
No. of Pins	2 + PE	3 + PE	4 + PE	5 + PE
Cable-Gland (field attachable)	PG 7	PG 11	Male: M16x1.5 Female: PG 11	PG 11
Cable-Range (field attachable)	ø 4.0 mm to 6.5 mm	ø 6.0 mm to 10.0 mm	ø 6.0 mm to 10.0 mm	ø 8.0 mm to 10.0 mm
Terminal Type (field attachable)	Screw	Screw	Screw	Crimp
Conductor Size (field attachable)	max. 1.5 mm ²	max. 1.5 mm ²	max. 1.5 mm ²	max. 1.0 mm ²
Cable Material (molded)	H05RR	H05RR	H05RR	–
Conductor Size (molded)	0.75 mm ²	0.75 mm ²	0.75 mm ²	–
Housing Color	Grey, Black	Grey, Black	Grey, Black	Grey, Black
 Electrical Data				
Operating Voltage	230 V AC/DC	400 V AC/230 V DC	400 V AC/230 V DC	400 V AC/230 V DC
Current	Molded: 10 A AC/DC Field attachable: 16 A AC/6 A DC Receptacle: 16 A AC/6 A DC	Molded: 10 A AC/DC Field attachable: 16 A AC/10 A DC Receptacle: 16 A AC/10 A DC	10 A AC/10 A DC	10 A DC/6 A AC
 Environmental Data				
Ambient Temperature*	-30 °C to +90 °C	-30 °C to +90 °C	-30 °C to +90 °C	-30 °C to +90 °C
Protection Degree	IP54	IP54	IP54	IP54
Approvals	Molded: VDE Field attachable: VDE, UL, SEV Receptacle: VDE, UL, SEV	Molded: VDE Field attachable: VDE, UL, SEV Receptacle: UL, VDE	Molded: VDE Field attachable: VDE, UL, SEV	VDE, SEV

* Notice derating and cable temperature





Product Configurator

Cordsets

S T A K **3** **K** **0 7 5** **S I** **V O** **2 M** **G R E Y**

Gender & Design

STAS = Male cordset, molded, straight
STAK = Female cordset, molded, straight

Pin Assignment

2 = 3-pole (2 + PE)
3 = 4-pole (3 + PE)
4 = 5-pole (4 + PE)

Assembly Design Indicator

K = Molded

Conductor Size

075 = 0.75 mm²

Safety Clamp (available for STAS)

= Without safety bracket
SI = With safety bracket

Flammability Class

= UL 94 HB
V0 = UL 94-V0

Cable Length

2M = 2 meter
5M = 5 meter
10M = 10 meter
Other cable lengths available upon request.
Please contact: icos-sales@belden.com

Housing Color

GREY = Grey housing
BLACK = Black housing

Field Attachables and Receptacles

S T A S **3 N** **V O** **G R E Y**

Gender & Design

STAS = Male connector, field attachable, straight
STASEI = Male connector, receptacle, front mount
STASAP = Male connector, receptacle, panel mount
STAK = Female connector, field attachable, straight
STAKEI = Female connector, receptacle, front mount
STAKAP = Female, receptacle, panel mount

Pin Assignment & Additional Features

2 = 3-pole (2 + PE)
20 = 3-pole (2 + PE), strain relief
200 = 3-pole (2 + PE), strain relief, coding slot
3 N = 4-pole (3 + PE)
4 N = 5-pole (4 + PE)
5 = 6-pole (5 + PE)

Flammability Class

V0 = UL 94-V0

Housing Color

GREY = Grey housing
BLACK = Black housing



Order Overview

ST Series	3-pole (2 + PE)		4-pole (3 + PE)	
	Male	Female	Male	Female
<p>1. Choose Coding →</p> <p>2. Choose Design ↓</p>				
Field Attachables				
Straight	STAS 2 V0 Grey	STAK 2 V0 Grey	–	–
Straight with strain relief	STAS 20 V0 Grey	STAK 20 V0 Grey	STAS 3 N V0 Grey	STAK 3 N V0 Grey
Straight with strain relief and coding slot	STAS 200 V0 Grey	STAK 200 V0 Grey	–	–
Receptacles				
Panel mount, screw type	STASAP 2 B V0 Grey	STAKAP 2 V0 Grey	STASAP 3 N V0 Grey	STAKAP 3 N V0 Grey
Panel mount, screw type with coding slot	STASAP 200 V0 Grey	STAKAP 200 V0 Grey	–	–
Panel mount, crimp type	–	–	–	–
Front mount with flange, screw type	STASEI 2 V0 Grey	STAKEI 2 V0 Grey	STASEI 3 N V0 Grey	STAKEI 3 N V0 Grey
Front mount with flange, screw type with coding slot	STASEI 200 V0 Grey	STAKEI 200 V0 Grey	–	–
Front mount with flange, crimp type	–	–	–	–
Single-Ended Cordsets				
Straight	–	–	–	STAK 3 K 075 V0 * M Grey
Straight with safety bracket	STAS 2 K 075 SI V0 * M Grey	–	STAS 3 K 075 SI V0 * M Grey	–
Accessories				
Safety bracket	STASI 2		STASI 3	
ST Series	5-pole (4 + PE)		6-pole (5 + PE)	
	Male	Female	Male	Female
<p>1. Choose Coding →</p> <p>2. Choose Design ↓</p>				
Field Attachables				
Straight	–	–	–	–
Straight with strain relief	STAS 4 N V0 Grey	STAK 4 N V0 Grey	STAS 5 V0 Grey	STAK 5 V0 Grey
Straight with strain relief and coding slot	–	–	–	–
Receptacles				
Panel mount, screw type	–	–	–	–
Panel mount, screw type with coding slot	–	–	–	–
Panel mount, crimp type	–	–	STASAP 5 V0 Grey	STAKAP 5 V0 Grey
Front mount with flange, screw type	–	–	–	–
Front mount with flange, screw type with coding slot	–	–	–	–
Front mount with flange, crimp type	–	–	STASEI 5 V0 Grey	STAKEI 5 V0 Grey
Single-Ended Cordsets				
Straight	–	STAK 4 K 075 V0 * M Grey	–	–
Straight with safety bracket	STAS 4 K 075 SI V0 * M Grey	–	–	–
Accessories				
Safety bracket	STASI 4		STASI 3	

Blue highlighted product features are available in different variants. Please see page 28 for more information.



Circular Connectors M23 Series

A perfect match – Power and Signal transmission in one interfaces

The powerful M23 Series makes it safe and easy to connect actuator/sensor and fieldbus modules. By virtue of their robust features, these connectors are ideal for applications in harsh industrial environments.



The Benefits

Braving any temperature – well-suited for climatic peaks from climate chambers to ovens

Efficient solution – due to fast, multi-pole connection interfaces; ideal for automation applications

Flexible solutions – including straight and angled molded as well as field attachable versions

Markets

- Machine building
- Automation
- Automotive
- Infrastructure

Technical Information

M23 Series	12-pole	19-pole
General Data		
No. of Pins	Molded: 11 + PE Field attachable: 12	Molded: 18 + PE Field attachable: 19
Cable-Gland (field attachable)	PG 13.5	PG 13.5
Cable-Range (field attachable)	ø 10.0 mm to 14.0 mm	ø 10.0 mm to 14.0 mm
Terminal Type (field attachable)	Solder	Solder
Conductor Size (field attachable)	max. 1 mm ²	max. 16X1 mm ² /3X1.5 mm ²
Cable Material (molded)	PUR	PUR
Conductor Size (molded)	8G0.5 mm ² /3X1 mm ²	16G0.5 mm ² /3X1.0 mm ²
Housing Color	Field attachable: Silver Molded: Black	Field attachable: Silver Molded: Black
Electrical Data		
Operating Voltage	120 V AC/DC	120 V AC/DC
Current	8 A AC/DC	Field attachable: 16 x 8 A/3 x 10 A AC/DC Molded: 16 x 8 A/3 x 10 A AC/DC
Environmental Data		
Ambient Temperature*	Field attachable: -40 °C to +125 °C Molded: -25 °C to +80 °C	Field attachable: -40 °C to +125 °C Molded: -25 °C to +80 °C
Protection Degree	Field attachable: IP65 Molded: IP67	Field attachable: IP65 Molded: IP67
Approvals	-	-

* Notice derating and cable temperature





Product Configurator

Cordsets

R K U **1 2** - **2 5 6** / **5 M**

Gender & Design

- RSU = Male cordset, molded, straight
- RSUF = Male cordset, molded, straight, external thread (fixed)
- RSWUF = Male cordset, molded, external thread, 90° angled, external thread (fixed)
- RKU** = Female cordset, molded, straight
- RKWU = Female cordset, molded, 90° angled
- RKUE = Female cordset, molded, straight, grounded screw (19-pole only)
- RKWUE = Female cordset, molded, 90° angled, grounded screw (19-pole only)

Pin Assignment

- 12** = 12-pole (11 + PE)
- 19** = 19-pole (18 + PE)

Cable Style

19-pole version

- 242** = 16G0.5 mm² + 3X1.0 mm², PUR, Black
- S4740** = 16G0.5 mm² + 3X1.0 mm², TPE, Yellow, PLTC

12-pole version

- 256** = 8G0.5 mm² + 3X1.0 mm², PUR, Black
- S4741** = 8G0.5 mm² + 3X1.0 mm², TPE, Yellow, PLTC

- X: Without PE Other cable styles available upon request.
- G: With PE Please contact: icos-sales@belden.com

Cable Length

- 5M** = 5 meter
 - 10M** = 10 meter
 - 15M** = 15 meter
 - 20M** = 20 meter
- Other cable lengths available upon request.
Please contact: icos-sales@belden.com

Field Attachables

R K C **1 2 0** / **1 3 , 5**

Gender & Design

- RSC = Male connector, field attachable, straight
- RSCW = Male connector, field attachable, 90° angled
- RSC-F = Male connector, field attachable, straight, external thread (fixed)
- RKC** = Female connector, field attachable, straight
- RKCW = Female connector, field attachable, 90° angled

Pin Assignment

- 120** = 12-pole
- 190** = 19-pole

Cable Gland

- 13,5** = PG 13.5



Order Overview

M23 Series	12-pole (11 + PE)		19-pole (18 + PE)	
	Male	Female	Male	Female
<p>1. Choose Coding →</p> <p>2. Choose Design ↓</p>				
Field Attachables				
Straight PG 13.5	RSC 120/13,5	RKC 120/13,5	RSC 190/13,5	RKC 190/13,5
Straight, external thread (fixed) PG 13.5	RSC-F-120/13,5	–	RSC-F-190/13,5	–
Angled PG 13.5	–	RKCW 120/13,5	RSCW 190/13,5	RKCW 190/13,5
Single-Ended Cordsets				
Straight	RSU 12-256/* M	RKU 12-256/* M	RSU 19-242/* M	RKU 19-242/* M
Straight, external thread (fixed)	RSUF 12-256/* M	–	RSUF 19-242/* M	–
Straight, grounded screw connection	–	–	–	RKUE 19-242/* M
Angled	RSWU 12-256/* M	RKWU 12-256/* M	RSWU 19-242/* M	RKWU 19-242/* M
Angled, external thread (fixed)	RSWUF 12-256/* M	–	RSWUF 19-242/* M	–
Angled, grounded screw connection	–	–	–	RKWUE 19-242/* M
Double-Ended Cordsets				
Straight-to-straight	RSU 12-RKU 12-256/* M		RSU 19-RKU 19-242/* M	
Straight-to-straight (Male with fixed external thread)	RSUF 12-RKU 12-256/* M		RSUF 19-RKU 19-242/* M	
Straight-to-angled	RSU 12-RKWU 12-256/* M		RSU 19-RKWU 19-242/* M	
Straight-to-angled (Male with fixed external thread)	RSUF 12-RKWU 12-256/* M		RSUF 19-RKWU 19-242/* M	
Angled-to-angled	RSWU 12-RKWU 12-256/* M		RSWU 19-RKWU 19-242/* M	
Accessories				
Spanner (for field attachable version)			ZMS 19	
Safety cab (for external thread version)			ZVK 2	

Blue highlighted product features are available in different variants. Please see page 32 for more information.





Circular Connectors Mini Power Series*

Full power ahead – for your industrial automation processes

With the Mini Power connectivity and power solution, you can easily set up, maintain or expand your system, while maximizing uptime in harsh conditions.



The Benefits

Maximum output – enabling the transmission of up to 30 A per contact

Long-distance power – works in environments with wet or dry areas or extreme temperatures

Time-saving – ready-to-install already terminated cordsets and connectors

Markets

- Machine building
- Automation
- Transportation
- Automotive

*only available in the US

Technical Information

Mini Power Series	A-Size 3-pole	A-Size 4-pole	D-Size 3-pole	D-Size 4-pole
				
 General Data				
No. of Pins	3 (2 + PE)	4 (3 + PE)	3 (2 + PE)	4 (3 + PE)
Cable-Gland (field attachable)	-	-	-	-
Cable-Range (field attachable)	-	-	-	-
Terminal Type (field attachable)	-	-	-	-
Conductor Size (field attachable)	-	-	-	-
Cable Material (molded)	TPE	TPE	TPE	TPE
Conductor Size (molded)	14 AWG	14 AWG	10 AWG	10 AWG
Housing Color	Black, Red	Black	Black, Red	Black
 Electrical Data				
Operating Voltage	600 V AC/DC	600 V AC/DC	600 V AC/DC	600 V AC/DC
Current	18 A AC/DC	15 A AC/DC	30 A AC/DC	25 A AC/DC
 Environmental Data				
Ambient Temperature*	-30 °C to +90 °C	-30 °C to +90 °C	-30 °C to +90 °C	-30 °C to +90 °C
Protection Degree	IP67, IP68	IP67, IP68	IP67, IP68	IP67, IP68
Approvals	UL	UL	UL	UL

* Notice derating and cable temperature





Product Configurator

Cordsets

R S P A | **3** - **8 0 2** / **5 M** -

Gender & Design

- RSP = Male cordset, 1 3/8", molded, straight
- RSPA** = Male cordset, 7/8", molded, straight
- RSWP = Male cordset, 1 3/8", molded, 90° angled
- RSWPA = Male cordset, 7/8", molded, 90° angled
- RKP = Female cordset, 1 3/8", molded, straight
- RKPA = Female cordset, 7/8", molded, straight
- RKWP = Female cordset, 1 3/8", molded, 90° angled
- RKWPA = Female cordset, 7/8", molded, 90° angled

Pin Assignment

- 3** = 3-pole (2 + PE)
- 4** = 4-pole (3 + PE)

Cable Style

D-Size = 1 3/8"

- 800** = 3G10 AWG, TPE, Black
- 803** = 4G10 AWG, TPE, Black

A-Size = 7/8"

- 802** = 3G14 AWG, TPE, Black
- 805** = 4G14 AWG, TPE, Black

Other cable styles available upon request.
Please contact: icos-sales@belden.com

Cable Length

- 0.5M** = 0.5 meter
- 5M** = 5 meter
- 10M** = 10 meter
- 20M** = 20 meter
- 30M** = 30 meter
- 50M** = 50 meter

Other cable lengths available upon request.
Please contact: icos-sales@belden.com

Housing Color

- = Black housing
- R** = Red housing

Receptacles

R S F P | **3** - **1 / 2 N P T** - **8 0 0** / **0 . 5 M**

Gender & Design

- RSFP** = Male cordset, 1 3/8", molded, straight
- RSFPA = Male cordset, 7/8", molded, straight
- RKFP = Female cordset, 1 3/8", molded, straight
- RKPFA = Female cordset, 7/8", molded, straight

Pin Assignment

- 3** = 3-pole (2 + PE)
- 4** = 4-pole (3 + PE)

Thread Size

- 1/2 NPT** = 1/2 NPT thread
- 3/4 NPT** = 3/4 NPT thread (1 3/8" only)

Cable Style

D-Size = 1 3/8"

- 800** = 3G10 AWG, TPE, Black
- 803** = 4G10 AWG, TPE, Black

A-Size = 7/8"

- 802** = 3G14 AWG, TPE, Black
- 805** = 4G14 AWG, TPE, Black

Other cable styles available upon request.
Please contact: icos-sales@belden.com

Cable Length

- 0.5M** = 0.5 meter
- 1M** = 1 meter
- 3M** = 3 meter

Other cable lengths available upon request.
Please contact: icos-sales@belden.com



Order Overview

Mini Power Series	D-Size 3-pole (2 + PE)		D-Size 4-pole (3 + PE)	
	Male	Female	Male	Female
<p>1. Choose Coding →</p> <p>2. Choose Design ↓</p>				
Receptacles				
Front mount 1/2 NPTF	RSFP 3-1/2NPT-800/*M	RKFP 3-1/2NPT-800/*M	RSFP 4-1/2NPT-803/*M	RKFP 4-1/2NPT-803/*M
Front mount 3/4 NPTF	RSFP 3-3/4NPT-800/*M	RKFP 3-3/4NPT-800/*M	RSFP 4-3/4NPT-803/*M	RKFP 4-3/4NPT-803/*M
Single-Ended Cordsets				
Straight	RSP 3-800/*M	RKP 3-800/*M	RSP 4-803/*M	RKP 4-803/*M
Angled	RSWP 3-800/*M	RKWP 3-800/*M	RSWP 4-803/*M	RKWP 4-803/*M
Double-Ended Cordsets				
Straight-to-straight	RSP 3-RKP 3-800/*M		RSP 4-RKP 4-803/*M	
Straight-to-angled	RSP 3-RKWP 3-800/*M		RSP 4-RKWP 4-803/*M	
Angled-to-straight	RSWP 3-RKP 3-800/*M		RSWP 4-RKP 4-803/*M	
Angled-to-angled	RSWP 3-RKWP 3-800/*M		RSWP 4-RKWP 4-803/*M	
Straight-to-Straight D-to-A-Size	RSP 3-RKPA 3-802/*M		RSP 4-RRKPA 4-805/*M	
Accessories				
Drop Tee Male-Female-Female	TAP-P 3 (-R)		TAP-P 4	
D-to-A-Size Reducer	RSP 3-RKPA 3 (-R)		RSP 4-RKPA 4	
Reducing Drop Tee Male-Female-Female	TAP-PA 3 (-R)		TAP-PA 4	
Reducing Cable Drop Tee Male-Female-Female	TAP-PA 3-802/*M (-R)		TAP-PA 4-804/*M	
Mini Power Series	A-Size 3-pole (2 + PE)		A-Size 4-pole (3 + PE)	
	Male	Female	Male	Female
<p>1. Choose Coding →</p> <p>2. Choose Design ↓</p>				
Receptacles				
Front mount 1/2 NPTF	RSFPA 3-1/2NPT-802/*M	RKFPA 3-1/2NPT-802/*M	RSFPA 4-1/2NPT-805/*M	RKFPA 4-1/2NPT-805/*M
Front mount 3/4 NPTF	-	-	-	-
Single-Ended Cordsets				
Straight	RSPA 3-802/*M	RKPA 3-802/*M	RSPA 4-805/*M	RKPA 4-805/*M
Angled	RSWPA 3-802/*M	RKWPA 3-802/*M	RSWPA 4-805/*M	RKWPA 4-805/*M
Double-Ended Cordsets				
Straight-to-straight	RSPA 3-RKPA 3-802/*M		RSPA 4-RKPA 4-805/*M	
Straight-to-angled	RSPA 3-RKWPA 3-802/*M		RSPA 4-RKWPA 4-805/*M	
Angled-to-straight	RSWPA 3-RKPA 3-802/*M		RSWPA 4-RKPA 4-805/*M	
Angled-to-angled	RSWPA 3-RKWPA 3-802/*M		RSWPA 4-RKWPA 4-805/*M	
Straight-to-Straight D-to-A-Size	RSP 3-RKPA 3-802/*M		RSP 4-RKPA 4-805/*M	
Accessories				
Drop Tee Male-Female-Female	TAP-A 3 (-R)		TAP-A 4	
D-to-A-Size Reducer	RSP 3-RKPA 3 (-R)		RSP 4-RKPA 4	
Reducing Drop Tee Male-Female-Female	TAP-PA 3 (-R)		TAP-PA 4	
Reducing Cable Drop Tee Male-Female-Female	TAP-PA 3-802/*M (-R)		TAP-PA 4-804/*M	

Blue highlighted product features are available in different variants. Please see page 36 for more information.



Economical connectivity solutions off the shelf and custom-made

The Connectivity Center

When it comes to automation technologies, we are the experts for quality connectors and wiring components. With an extensive Hirschmann Industrial Connector and Lumberg Automation Connectivity product portfolio, we can offer you a wide range of standard solutions.

Require a specialized solution that does not yet exist or have a problem with your current solution?

Then you simply get in touch with our Connectivity Center: the platform for custom-made solutions developed specifically for your needs. By combining all of our knowledge and internal resources, we will deliver the exact solution you need to smooth out your production process, warrant continuity and reduce Total Cost of Ownership.

The Best Solutions ... Fast!

With a dedicated team of experts, we can meet even the most demanding deadlines and technical challenges. Every month, the Connectivity Center delivers approximately 100 customized solutions for customers worldwide. Some within just two weeks, hardly ever longer than three months. All solutions are guaranteed to have outstanding compact design, chemical resistance as well as high mechanical and electrical loading capacity.





Combined Strength of Three Belden Brands

Belden is a leader in the design, manufacture, and marketing of signal transmission products for data networking and a wide range of industrial connectivity products. Whenever necessary we combine the strength of all three powerful Belden brands: Belden, Hirschmann and Lumberg Automation.



Pushing Technology, Meeting Standards

insights trends developments

As a globally active technology leader we can translate the latest trends, insights and developments into custom-fit solutions that give you the competitive advantage you are looking for. Thanks to extensive prototyping and intensive testing in our own facilities, you can be sure national and international standards are met. You can put our solutions straight to work.

Add Value to Your Business

You can be certain we provide signal transmission solutions that make your company operate faster, better, longer, safer and more economically. It's our ambition to deliver all these benefits to you from a single source, building a lasting relationship that adds value to your business.

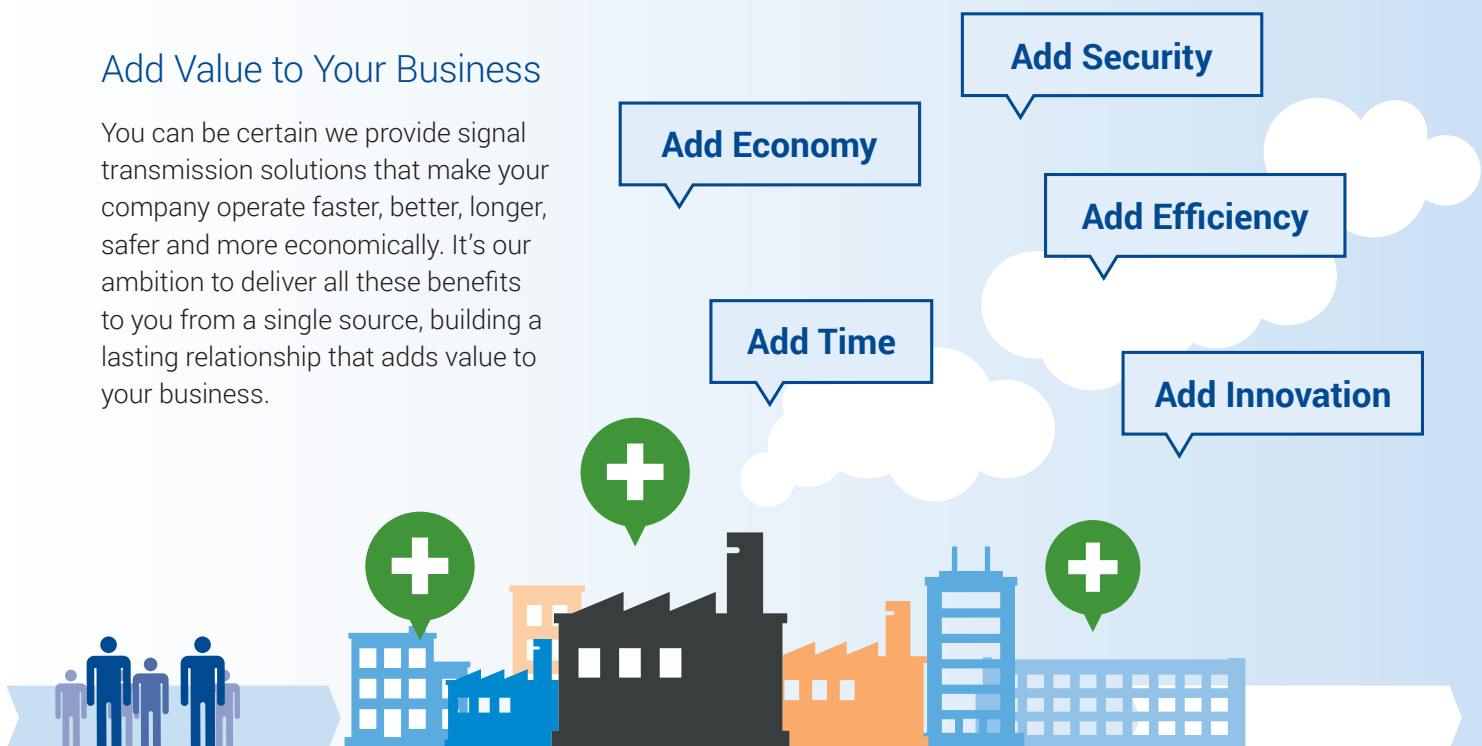



About Belden

Belden Inc., a global leader in high quality, end-to-end signal transmission solutions, delivers a comprehensive product portfolio designed to meet the mission-critical network infrastructure needs of industrial, enterprise and broadcast markets. With innovative solutions targeted at reliable and secure transmission of rapidly growing amounts of data, audio and video needed for today's applications, Belden is at the center of the global transformation to a connected world. Founded in 1902, the company is headquartered in St. Louis, USA, and has manufacturing capabilities in North and South America, Europe and Asia.

For more information, visit us at:

www.belden.com

www.beldensolutions.com

follow us on Twitter @BeldenIND