

Manual

LioN-P PROFINET IO-Link Master S2

(with PROFINET System Redundancy S2)

...

0980 ESL 399-121-S2

Contents

1 About this manual	7
1.1 General information	7
1.2 Explanation of symbols	8
1.2.1 Use of danger information	8
1.2.2 Use of general information	8
1.3 Version information	8
2 Safety instructions	9
2.1 Intended use	9
2.2 Qualified personnel	10
3 Designations and synonyms	11
4 System description	12
4.1 PROFINET product features	12
4.2 IO port features	15
4.3 PROFINET System Redundancy S2	17
4.4 Integrated web server	19
4.5 Other features	20
5 Assembly and wiring	21
5.1 General information	21
5.2 Outer dimensions	22
5.2.1 Module 0980 ESL 3x8-121 & ESL 3x9-121	22

5.2.2 Module 0980 ESL 1x9-121	23
5.2.3 Module 0980 ESL 1x9-332	24
5.2.4 Module 0980 ESL 1x9-122	25
5.2.5 Module 0980 ESL 1x9-331	26
5.3 Port assignments	27
5.3.1 PROFINET ports, M12 socket, 4-pin, D-coded	27
5.3.2 Power supply with M12 power L-coded	28
5.3.3 PROFINET and power supply with M12 Hybrid	29
5.3.4 IO ports as M8 or M12 sockets	30
5.3.4.1 IO-Link Type A	30
5.3.4.2 IO-Link Type B	31

6 Starting operation 33

6.1 GSDML file	33
6.2 MAC addresses	33
6.3 State on delivery	34
6.4 Module configuration in the SIEMENS TIA Portal®	35
6.4.1 Assigning a device name and IP address	37
6.4.2 Configuring the IO-Link channels	39
6.4.2.1 Deleting the configuration of a specified IO-Link channel	39
6.4.2.2 Creating an IO-Link channel configuration	41
6.4.3 Parameterization of the IO-Link channels	44
6.4.3.1 Failsafe Configuration	45
6.4.3.2 IO-Link Port Parameters	47
6.4.4 Parameterization of the Status/Control Module	53
6.4.4.1 General Device Settings	54
6.4.4.2 General Diagnostic Settings	57
6.4.4.3 Failsafe Configuration (DO-Mode)	58
6.4.5 Surveillance Timeout Configuration (LioN-P 60 devices)	59
6.4.6 Digital Input Logic	60
6.4.7 Digital-IO mode for Ch. B/Pin 2	61
6.4.7.1 Digital-IO mode for Ch. B/Pin 2 (LioN-P 30 devices)	61
6.4.7.2 Digital-IO mode for Ch. B/Pin 2 (LioN-P 60 devices)	61
6.5 IO-Link Device Parameterization	63

6.5.1 SIEMENS IO-Link library	63
6.5.1.1 SIEMENS function block FB50001 – read example	64
6.5.1.2 SIEMENS function block FB50001 – write example	65
6.5.2 SIEMENS WRREC and RDREC	66
6.5.2.1 Write sequence	66
6.5.2.2 Read sequence	73
6.5.2.3 Error PDU for the Read/Write sequence	80
6.6 SNMP	82
6.7 Media Redundancy Protocol (MRP)	83
6.8 Identification & maintenance functions (I&M)	85
6.8.1 Supported I&M features	85
6.8.1.1 I&M data of the PN-IO Device	85
6.8.1.2 I&M data of the IOL-Master proxy (Status/Control Module)	88
6.8.1.3 I&M data of the IOL-Device proxy	90
6.8.2 Reading and writing I&M data	93
6.8.2.1 I&M Read Record	94
6.8.2.2 I&M Write Record	95
6.9 Fast Start-Up (FSU) / Prioritized Start-Up	96

7 Bit assignment 97

7.1 Process data Status/Control Module, slot 1.1/IO System 1	97
7.1.1 Status/Control data with Bit Mapping Mode 1 (default mapping)	99
7.1.1.1 Digital Input Status with BMM1 & Byte Order Mode 1	99
7.1.1.2 Digital Input Status with BMM1 & Byte Order Mode 2	99
7.1.1.3 Digital Output Control with BMM1 & Byte Order Mode 1	100
7.1.1.4 Digital Output Control with BMM1 & Byte Order Mode 2	101
7.1.2 Status/Control data with Bit Mapping Mode 2 (Retrofit)	102
7.1.2.1 Digital Input Status with BMM2 & Byte Order Mode 1	102
7.1.2.2 Digital Input Status with BMM2 & Byte Order Mode 2	102
7.1.2.3 Digital Output Control for BMM2 & Byte Order Mode 1	103
7.1.2.4 Digital Output Control for BMM2 & Byte Order Mode 2	104
7.2 Process data IO-Link ports, Slot 1.2 – 1.9	105

8	Diagnostics processing	108
8.1	Error of the system/sensor power supply	108
8.2	Error of the auxiliary/actuator power supply	108
8.3	Overload/short-circuit of the IO port sensor supply outputs	109
8.4	Overload/short circuit of the digital 500 mA outputs	109
8.5	Overload/short circuit of the digital outputs	110
8.6	Overload/short circuit of the Type B port aux. power supply	111
8.6.1	For LioN-P 30 devices	111
8.6.2	For LioN-P 60 devices	112
8.7	IO-Link C/Q error	112
8.8	IO-Link Device Diagnostics	113
9	IO-Link Device Configuration Tool	114
10	The integrated web server	116
10.1	The Status page	117
10.2	The Ports page	118
10.3	The System page	119
10.4	The User page	121
11	Technical data	122
11.1	General	122
11.2	PROFINET protocol	123
11.3	Power supply of the module electronics/sensors	124
11.4	Power supply of the type B ports (auxiliary supply)	125
11.5	IO-Link Master Ports (X1 - X8, Ch. A / C/Q / Pin 4)	125
11.5.1	Configured as a digital input	126
11.5.2	Configured as a digital output (except 0980 ESL 3x8-121)	126
11.5.3	Configured as an IO-Link port in COM mode	127

11.6 Digital inputs (X1 – X4, type A ports, Ch. B/Pin 2)	127
11.7 LioN-P 60: U _{Aux} config. as a digital output (X5 - X8, type B ports, Ch. B/Pin 2)	129
11.8 LioN-P 30: U _{Aux} (X5 - X8)	130
11.9 Differences between 0980 ESL 3x8-121 and 0980 ESL 3x9-121	131
11.10 LEDs	132

12 Accessories

134

1 About this manual

1.1 General information

Please read the assembly and operating instructions in this manual carefully before starting up the LioN-P modules with PROFINET IO interface. Keep the manual where it is accessible to all users.

The texts, figures, diagrams, and examples used in this manual are used exclusively to explain how to operate and apply the LioN-P modules with PROFINET IO interface.

Please contact us if you have any detailed questions on installing and starting up the devices.

Belden Deutschland GmbH
– Lumberg Automation™ –
Im Gewerbepark 2
D-58579 Schalksmühle
Germany
<https://lumberg-automation-support.belden.com>
www.lumberg-automation.com

Belden Deutschland GmbH – Lumberg Automation™ – reserves the right to make technical changes or changes to this manual at any time without notice.

1.2 Explanation of symbols

1.2.1 Use of danger information

Danger information is denoted as follows:



Danger: Means that death, serious physical injury or substantial damage to property will occur if the required safety measures are not taken.



Warning: Means that death, serious physical injury or substantial damage to property can occur if the required safety measures are not taken.



Caution: Means that minor physical injury or damage to property can occur if the required safety measures are not taken.

1.2.2 Use of general information

General information is denoted as follows:



Attention: Contains important information on the product, on how to manage the product, or on the respective section of the documentation to which your special attention is being drawn.

1.3 Version information

Index	Created	Changed
Version number	Version 1.0	
Date	2020-04-23	
Name/department	JGA / R&D	

Table 1: Overview of manual revisions

2 Safety instructions

2.1 Intended use

The devices described in this manual are decentralized input/output assemblies on a PROFINET IO network.

We adhere to all safety standards when developing, producing, testing, and documenting our products. When you adhere to the handling specifications and safety instructions described for the configuration, assembly, and correct operation, there should not normally be any risks for people or equipment.

The modules fulfill the requirements of the EMC guidelines (89/336/EEC, 93/68/EEC and 93/44/EEC) and the low voltage guideline (73/23/EEC).

The modules are designed to be used in the industrial sector. The industrial environment is distinguished by the fact that the consumer is not connected directly to the public low voltage network. Additional measures are required for use in residential areas or in business and commercial sectors.



Attention: This equipment may cause radio interference in residential areas. In this case the operator may be requested to carry out appropriate measures.

The proper and safe operation of this product depends on proper transportation, storage, assembly, and installation, and careful operation.

A completely assembled device housing is required for the proper operation of the modules. Only connect devices to the modules that fulfill the requirements of EN 61558-2-4 and EN 61558-2-6.

During the configuration, installation, start-up, maintenance, and testing of the devices, adhere to the safety and accident-prevention guidelines for the specific application.

Only install cables and accessories that fulfill the requirements and regulations for safety, electromagnetic compatibility, and, where applicable, telecommunication end devices, as well as the specification information.

Information on which cables and accessories are permitted for the installation can be obtained from Lumberg Automation™ or is contained in this manual.

2.2 Qualified personnel

The configuration, installation, start-up, maintenance, and testing of the devices may only be performed by a qualified electrician who is familiar with the safety standards of the automation technology.

The personnel requirements are based on the requirement profiles described by ZVEI, VDMA, or equivalent organizations.

Only electricians who are familiar with the content of this manual are authorized to install and maintain the devices described. These are persons who

- ▶ based on their technical training, knowledge, and experience, and their knowledge of the pertinent standards, can evaluate the work to be carried out and identify any potential risks or
- ▶ based on working for several years in a related sector, have the same level of knowledge as they would have from the relevant technical training.

Only Belden Deutschland GmbH – Lumberg Automation™ – is permitted to make changes to the hardware or software of the products that go beyond the scope of this manual.



Warning: Making unqualified changes to the hardware or software, or non-adherence to the warning information contained in this manual, can result in serious personal injury or damage to equipment.

3 Designations and synonyms

C/Q	IO port pin 4 mode, IO-Link communication/switching signal
DI	Digital Input
DO	Digital Output
ETH	ETHERNET
I/Q	IO port pin 4 mode, Digital Input/switching signal
IO	Input / Output
IO port	X1 - X8
IO port pin 2	Channel B of X1 - X8
IO port pin 4 (C/Q)	Channel A of X1 - X8
L+	IO port pin 2, sensor power supply
LioN-P 30	LioN-P devices with a width of 30mm
LioN-P 60	LioN-P devices with a width of 60mm
MP	Multi Protocol (PROFINET and EtherNet/IP and EtherCAT®)
PN	PROFINET
PWR	Power
SP	Single Protocol (PROFINET or EtherNet/IP)
Type A	IO-Link port specification (Class A)
Type B	IO-Link port specification (Class B)
U _{Aux}	U _{Auxiliary} ¹⁾ .
UINT16	Word in PLC (IW, QQ)
UINT8	Byte in PLC (IB, QB)
High-B	High-Byte
Low-B	Low-Byte

1). U_{Auxiliary} is the auxiliary power supply to the IO-Link type B ports X5 - X8 or the actuator power supply to the digital A outputs on ports X5 - X8 (LioN-P 60).

4 System description

LioN modules (Lumberg Automation™ Input/Output Network) function as the interface in an industrial fieldbus system: They enable a central controller on the management level to communicate with the decentralized sensors and actuators on the field level. The line or ring topologies for which they can be used ensure not only reliable data communication but also significantly reduce the number of cables required and thus also the costs for and maintenance. They additionally enable easy and quick extension.

The modules of the LioN-P series have been substantially reduced in size compared with the well-known LioN-R family; the modules have a very rugged metal housing made of die-cast zinc. Housing variants with widths of 30 mm and 60 mm and different connector types are available. The completely cast device housing protects the module electronics from environmental effects and allows the device to be used in a wide temperature range. Despite the sturdy construction, the modules have compact dimensions and a low weight. They are especially suitable for use in machines and installations with a moderate IO concentration over separate assemblies.

4.1 PROFINET product features

Data connection

The connection options provided by the module series are the widely-used M12 connector with D coding and the M12 hybrid connector for the PROFINET IO network.

The connectors are also color-coded to prevent the ports from being mixed up.

Data transmission rates

Featuring a transmission rate of up to 100 MBit/s, the PROFINET modules can handle both fast transmission of IO data and transmission of larger volumes of data.

PROFINET IO Device RT

The LioN-P IO-Link Master modules support PROFINET IO Device RT (real-time). This allows the transmission of time sensitive process data between network components in real-time communication.

PROFINET specification V2.35, Conformance Class C (CC-C)

The LioN-P IO-Link Master modules comply with PROFINET specification V2.35 and meet the requirements of Conformance Class C (CC-C) for the integrated switch.

Integrated switch

The integrated Ethernet switch with Conformance Class C (CC-C) has two PROFINET ports and thus supports the establishment of a line or ring topology for the PROFINET IO network.

PROFINET System Redundancy S2

The PROFINET System Redundancy S2 (S = Single network access point, 2 = can switch between two application relations) uses a system of one single PROFINET device connected with two redundant PROFINET controllers. In this way, in the event of a failure of the connection to the primary controller, the additional backup controller can take over the IO data exchange connection.

Media Redundancy Protocol

The additionally implemented Media Redundancy Protocol (MRP) enables the design of a highly available network infrastructure.

Fast Start-Up (FSU)

Fast Start-Up is an accelerated start-up process that enables LioN-P modules to start communicating on an PROFINET network after a very short time. This makes a faster tool change possible, for example. Thanks to

the FSU feature, the modules are ready to operate in less than 3000 ms.

Shared Device

This function is only applicable for systems without using S2 System Redundancy.

With the shared device functionality, two controllers can access the same IO device via a PROFINET interface. This option is done by copying the configuration of the IO device into the first and second controller and assigning it to the second controller as shared device. Only the input data of the PROFINET IO device can be shared between different controllers. (Refer to the PLC manual)

DCP

The master modules use the DCP protocol to automatically assign IP addresses.

LLDP

The LLDP protocol is used to detect devices in the vicinity (neighborhood detection).

SNMP

The SNMP protocol (according PROFINET standard V2.35) handles network component monitoring and communication between the master and device.

Alarm and diagnostic messages

The modules support extended PROFINET alarm and diagnostic messages.

I&M functions

Identification and maintenance data (I&M) means information stored on the module. The identification data consist of manufacturer details for the module and can only be read. The maintenance data consist of system specific details created during the course of configuration. The modules can be uniquely identified online via the I&M data.

The device supports I&M data related to the PNO 2.832 standard (IO-Link Integration - Edition 2):

I&M0 ... I&M3 for the interface module (access slot, subslot 0x8000)

I&M0 for the IO-Link Master proxy

I&M0 and I&M5 for the IO-Link Device proxies

GSDML-based configuration and parameterization of the IO ports

The GSDML offers the option of configuring and parameterizing the IO ports on the master modules.

4.2 IO port features

IO-Link specification.

The IO-Link Master module supports the IO-Link standard v1.1.

8 x IO-Link Master ports

The module has 4 type A ports with an additional hard-wired digital input on pin 2 of the IO port.

Variants with a width of 30 mm:

4 x type B ports with electrically isolated auxiliary power supply on pins 2 and 5 of the IO port with a total of 4 A current.

Variants with a width of 60 mm:

4 x type B ports with electrically isolated auxiliary power supply for up to 2 A per port on pins 2 and 5 with a total of 8 A current.

The auxiliary power supply can optionally be configured as a digital output.



Warning: If modules with electric isolation and modules without electric isolation are used within the same system, the electric isolation of all connected modules is annulled.

IO-Link port connections

The IO-Link port connection option provided by the module series is the 5-pin M12 connector, or the 5-pin M8 connector.

Validation & Backup (former Backup & Restore)

The Validation & Backup function checks if the right device is connected and stores/monitors the parameters of the IO-Link Device and the IO-Link Master. The function thus gives you an easy option for replacing the IO-Link Device or IO-Link Master.

This is possible as of IO-Link specification V1.1 and only if the IO-Link Device **and** the IO-Link Master support the function.

IO device parameterization

IO-Link Device parametrization in PROFINET via the Siemens IO_LINK_DEVICE function block (FB50001) for Siemens TIA Portal®.

IO-Link Device parametrization via TMG TE GmbH IO-Link Device Tool (V5.x or higher). The tool is usable as standalone PC-Application or callable via Siemens TIA Portal®.

LED

You can see the status of a port by the color of the matching LEDs and their flash pattern. For details on the meanings of the LED colors, please see section [LEDs](#) on page 132.

4.3 PROFINET System Redundancy S2

System redundancy specifies the usage of PROFINET to build up a system with redundant PROFINET controllers and single or redundant PROFINET devices. In contrast to a 1-1 connection of one CPU and one device, the failure of a controller in this case does not necessarily lead to a total outage of the system functionality.

The PROFINET System Redundancy S2 uses a system of one single PROFINET IO device with a single network interface (NAP = Network Access Point) connected with two redundant PROFINET IO controllers. The NAP S2 configuration provides the possibility of an automatic switch-over from the primary controller to the additional backup controller if the connection to the primary controller fails. Both CPUs build an SR-AR connection to the IO device and are in continuous operation. If one of the redundant partners fails, the master role is transferred to maintain the function.

SR-AR

Each of the involved redundant controllers establishes a connection to the IO-Link Master, a so-called SR-AR (System Redundancy Application Relation). Typically, one SR-AR is the primary SR-AR, the other one serves as backup SR-AR.

Switch over

In the event of a failure of the connection to the primary controller, the backup controller takes over and becomes the primary controller. During switch-over, the PROFINET IO device holds its outputs, and the inputs are frozen.

Reasons for switch-over initiation

The switch over will be triggered by a fail of the primary SR-AR. Alternatively, the switch over can be forced by the host (via primary request by the other controller).

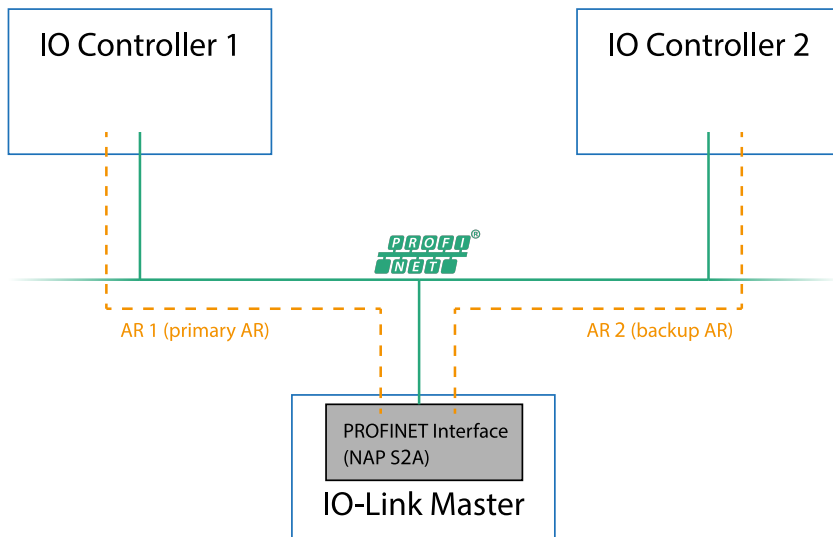

Figure 1: Schematic diagram of the *PROFINET System Redundancy S2*

4.4 Integrated web server

Network parameter display

The integrated web server provides the option of viewing network parameters such as the IP address, subnet mask and gateway.

Displaying diagnostics

View diagnostics via the integrated web server.

User management

Use the integrated web server for convenient management of all users.

IO-Link Device parameters

You can read the IO-Link Device parameters via the integrated web server and write new parameters in single write mode (single write mode doesn't activate the automated mechanism of the "Validation and Backup" function) to the IO-Link Device modules.

4.5 Other features

Interface protection

The modules have reverse polarity, short-circuit and overload protection for all interfaces.

For more details, see section [Port assignments](#) on page 27.

Failsafe

The modules support a failsafe function. This allows you to define the behavior of every single channel configured as an output in the case of a loss of the PROFINET communication.

Color-coded connectors

Color-coded connectors help you avoid confusion in your cabling.

IP protection classes 65/67/69k

The IP protection classes describe environmental influences that the modules can be exposed to without risk and without suffering damage, or causing a risk for the user.

Depending on the module, IP protection classes IP65, IP67 or IP69k are offered.

5 Assembly and wiring

5.1 General information

Mount the module on a flat surface using 2 screws (M4x 25/30). The torque required here is 1 Nm. Use washers for all fastening methods as per DIN 125.



Attention: The modules have a ground connection with an M4 thread for the conduction of interference currents and the EMC immunity. This is labeled with the symbol for the ground and the designation "XE"



Attention: Use a low-impedance connection to connect the module to the reference ground. When using a grounded mounting surface, you can make the connection directly via the fixing screws.



Attention: If the mounting surface is ground-free, use a ground strap or a suitable PE line. Use an M4 screw to connect the ground strap or the PE line to the ground point and if possible put a washer and a toothed washer below the fixing screw.

5.2 Outer dimensions

5.2.1 Module 0980 ESL 3x8-121 & ESL 3x9-121

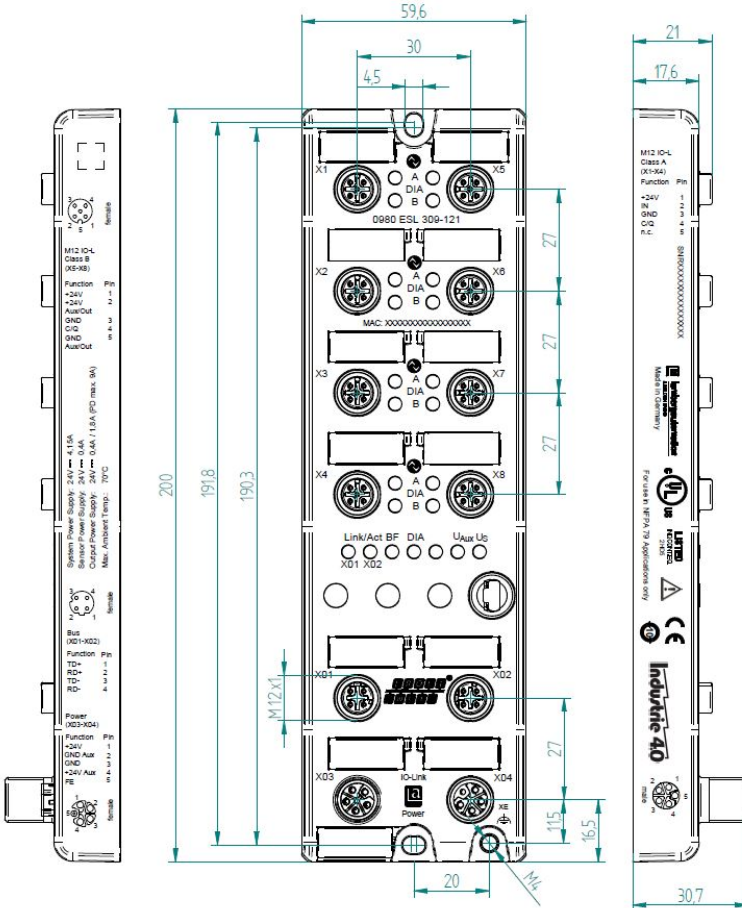

5.2.3 Module 0980 ESL 1x9-332

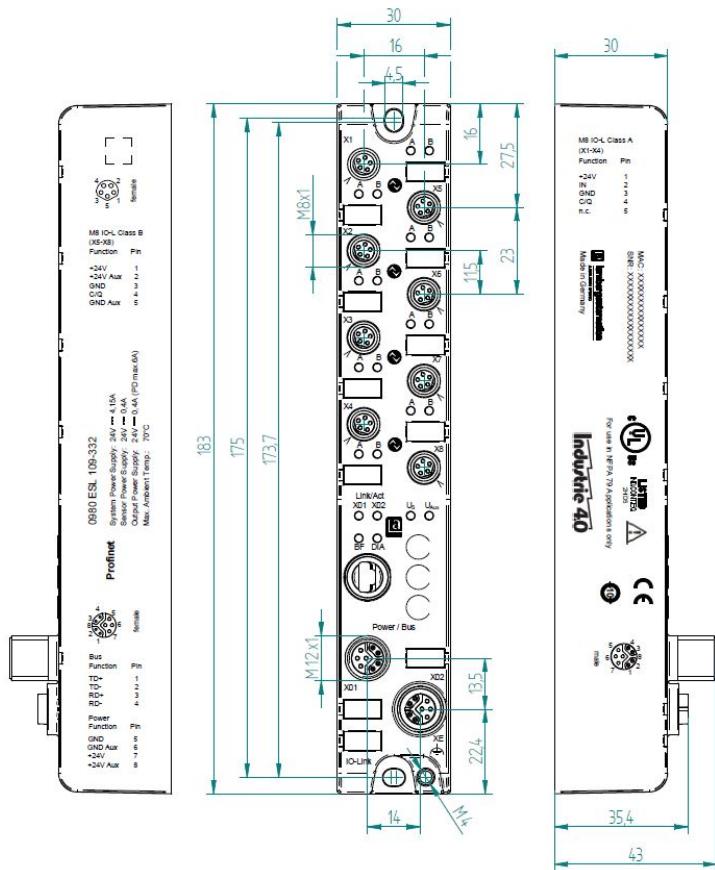



Attention: For U_L application:

Be sure to use a UL-certified cable with a suitable evaluation to connect the devices (CYJV or PVVA). To program the control, please refer to the OEM information, and only use suitable accessories.

Only approved for interior use. Please note the maximum elevation of 2000 meters. Approved up to a maximum soiling level of 2.



Warning: Terminals, housings field-wired terminal boxes or components can exceed temperatures of 60° C.



Warning: For UL application (max. ambient Temperature +70° C):

Use temperature-resistant cables with the following properties:

For the modules 0980 ESL1x9-1xx heat-resistant up to at least 85° C.

For the modules 0980 ESL1x9-33x heat-resistant up to at least 104° C.

For the modules 0980 ESL3x9-xxx heat-resistant up to at least 96° C.

For the modules 0980 ESL3x8-xxx heat-resistant up to at least 101° C.

5.3 Port assignments

All the contact arrangements shown in this chapter show the frontal view of the connection area for the connectors.

5.3.1 PROFINET ports, M12 socket, 4-pin, D-coded

Color coding: green

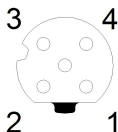

Figure 2: Schematic drawing, ports X01, X02

Port	Pin	Signal	Function
PROFINET Ports X01, X02	1	TD+	Transmit data plus
	2	RD+	Receive data plus
	3	TD-	Transmit data minus
	4	RD-	Receive data minus

Table 2: Assignment of ports X01, X02



Caution: Risk of destruction! Never connect the power supply to the data cables.

5.3.2 Power supply with M12 power L-coded

Color coding: gray

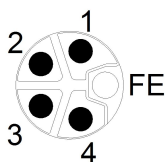

Figure 3: Schematic diagram of the M12 L-coding (connector)

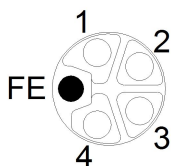

Figure 4: Schematic diagram of the M12 L-coding (socket)

Power supply	Pin	Signal	Function
	1	U_S (+24 V)	Sensor/system power supply
	2	GND_ U_{Aux}	Ground/reference potential U_{Aux}
	3	GND_ U_S	Ground/reference potential U_S
	4	U_{Aux} (+24 V)	Auxiliary supply (electrically isolated to U_S)
	5	FE (PE)	Functional ground

Table 3: Power supply with M12-Power



Attention: Only use power supply units for the system/sensor and actuator supply that correspond to PELV (Protective Extra Low Voltage) or SELV (Safety Extra Low Voltage). Power supplies according to EN 61558-2-6 (transformers) or EN 60950-1 (switching power supply units) fulfill these requirements.

5.3.3 PROFINET and power supply with M12 Hybrid

Color coding: gray

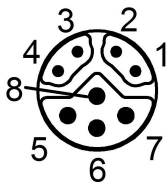

Figure 5: Schematic diagram of the M12 Hybrid (connector)

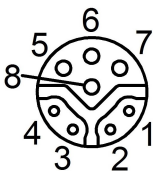

Figure 6: Schematic diagram of the M12 Hybrid (socket)

Ether + Power Supply	Pin	Signal	Function
PROFINET Ports X01, X02	1	TD+	Transmit data plus
	2	RD+	Receive data plus
	3	TD-	Transmit data minus
	4	RD-	Receive data minus
	5	GND_U _S	Ground/reference potential GND_U _S
	6	GND_U _{Aux}	Ground/reference potential GND_U _{Aux}
	7	U _S (+24 V)	Sensor/system power supply
	8	U _{Aux} (+24 V)	Auxiliary supply (electrically isolated)

Table 4: PROFINET and power supply with M12 Hybrid

i **Attention:** Only use power supply units for the system/sensor and actuator supply that correspond to PELV (Protective Extra Low Voltage) or SELV (Safety Extra Low Voltage). Power supplies according to EN 61558-2-6 (transformers) or EN 60950-1 (switching power supply units) fulfill these requirements.

5.3.4 IO ports as M8 or M12 sockets

5.3.4.1 IO-Link Type A

Color coding: black

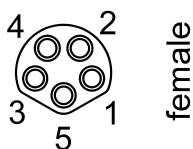

Figure 7: Schematic drawing IO port as M8 socket IO-Link Type A

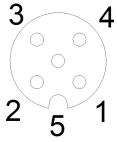

Figure 8: Schematic drawing IO port as M12 socket IO-Link Type A

IO-Link Type A	Pin	Signal	Function
	1	L+	IO-Link sensor power supply +24 V
	2	IN-x	Ch. B: Digital input (type 1)
	3	L-	IO-Link sensor supply GND _{Us}
	4	C/Q	Ch. A: IO-Link data communication
	5	NC	not connected

Table 5: IO ports as M8 or M12 socket IO-Link Type A

5.3.4.2 IO-Link Type B

Color coding: black

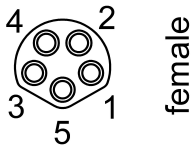

Figure 9: Schematic drawing IO port as M8 socket IO-Link Type B

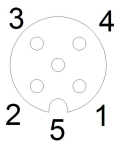

Figure 10: Schematic drawing IO port as M12 socket IO-Link Type B

IO-Link Type B	Pin	Signal	Function
	1	L+	IO-Link sensor power supply +24 V
	2	2L+ (U _{Aux})	Ch. B: Auxiliary power supply (electrically isolated with respect to the sensor/system power supply)
	3	L-	IO-Link sensor supply GND_U _S
	4	C/Q	Ch. A: IO-Link data communication
	5	2M (GND_U _{Aux})	Ground/reference potential U _{Aux}

Table 6: IO ports as M8 or M12 socket IO-Link Type B



Warning: IO Port – Sensor supply:

The sensor supply may only be carried out via the specified power connection (Power X03 --> US +24 V/GND_U_S) of the module. An external power supply over the IO port (Port X1-X8 --> Pin1/Pin3) is not permitted and can lead to a destruction of the module electronics!



Warning: IO Port connection (IO-Link - Class B):

The sensor supply (Port X5-X8 --> Pin1/Pin3) and the extended sensor supply (Port X5-X8 --> Pin2/Pin5) are galvanic isolated from each other. If the reference potentials (GND_US - Pin3) and (GND_UAux - Pin5) are connected, unacceptable compensation currents can flow. In this case the connection of a sensor at (Port X5-X8 --> Pin2) is not allowed!

The removal of the galvanic separation is not recommended.

6 Starting operation

6.1 GSDML file

A GSD file in XML format is required to configure the LioN-P-S2 modules. All module variants are grouped in a single GSDML file. This can be downloaded from our homepage:

https://catalog.belden.com/index.cfm?event=browse&c=Category_173379.

On request, the GSDML file is also sent by the support team.

The GSDML file and the associated bitmap files are grouped in the archive file named **GSDML-V2.35-BeldenDeutschland-LioN-P-S2-yyyymmdd.xml**.

yyyymmdd stands for the date on which the file was issued.

Download this file and unpack it.

In Siemens TIA Portal® you create a new project and open the hardware manager under **Configure a device**. Under the menu command **Options > Manage general station description files (GSD)** the GSD file is installed by defining the file path.

The LioN-P-S2 modules with PROFINET interface are then available in the hardware catalog.

6.2 MAC addresses

Every module has three unique MAC address assigned by the manufacturer that cannot be changed by the user. The first assigned MAC address is printed of the module.

6.3 State on delivery

PROFINET parameters in state on delivery or after a factory reset:

PROFINET name:	Name not assigned
IP address:	0.0.0.0
Subnet mask:	0.0.0.0
Device designations:	0980 ESL 109-121-S2 0980 ESL 109-122-S2 0980 ESL 109-331-S2 0980 ESL 109-332-S2 0980 ESL 308-121-S2 0980 ESL 309-121-S2 0980 ESL 199-121-S2 0980 ESL 199-122-S2 0980 ESL 199-331-S2 0980 ESL 199-332-S2 0980 ESL 398-121-S2 0980 ESL 399-121-S2
Vendor ID:	0x016a
Device ID:	0x0380

6.4 Module configuration in the SIEMENS TIA Portal®

After installing the GSDML files for the LiON-P-S2 PROFINET modules, they are available in the hardware catalog under **Other field devices > PROFINET IO > IO > Belden Deutschland GmbH - Lumberg Automation > Lumberg Automation LiON-P-S2**.

1. First, configure the TIA Portal® project and the control system in the usual way. Assign an IP address and subnet mask for the PROFINET port of the control unit.
2. Then choose the desired device from the Hardware catalog:

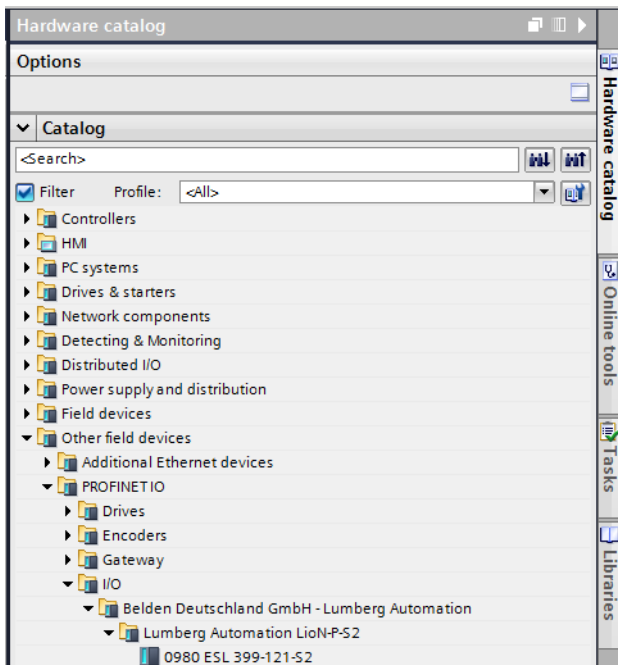

Figure 11: TIA Portal® Hardware catalog

- Click on the article designations of the modules in the hardware catalog and drag and drop the desired device into the network view:

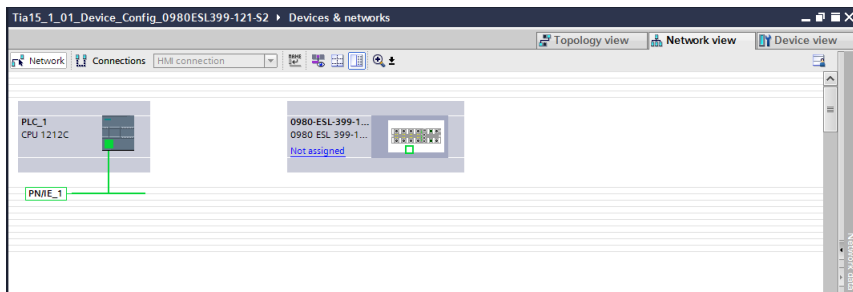

Figure 12: Network view

- Assign the device to the PROFINET network:

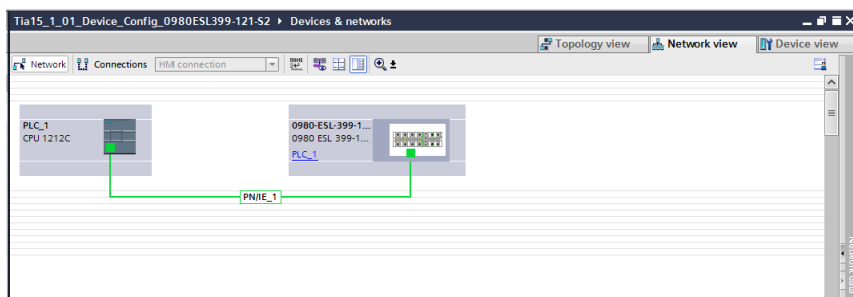

Figure 13: Assign device

- Switch to the device configuration view and select the device to display configuration options:

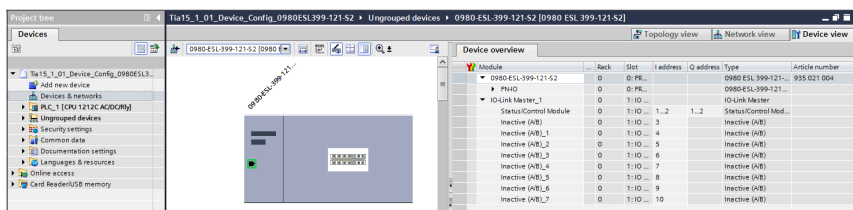

Figure 14: Device configuration

6.4.1 Assigning a device name and IP address

PROFINET IO devices are addressed on PROFINET via a unique device name. This can be freely assigned by the user, but may only be used once on the network.

1. A click on the device icon or on the first line of the **Device overview** opens the settings for **PROFINET interface > Ethernet addresses**:

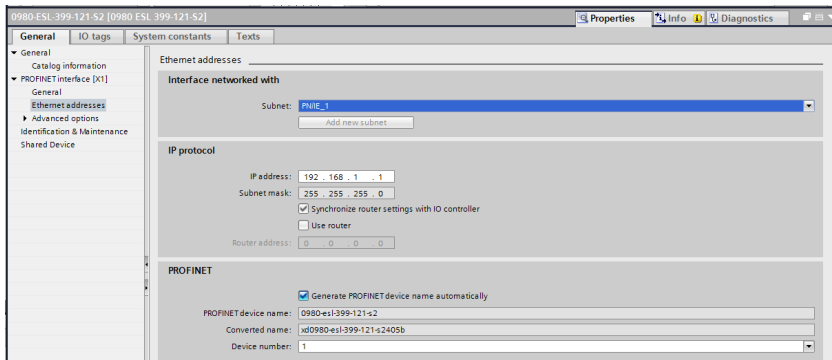

Figure 15: ETHERNET addresses

2. Check that the control unit and the IO device are on the same Ethernet Subnet.
3. Accept the default settings for IP address and device name or change them if desired.
4. For a correctly working setup, the chosen device name must be programmed online in the IO device. When the HW is already installed, you can easily change to online mode. The new IO device should already be accessible via PROFINET:

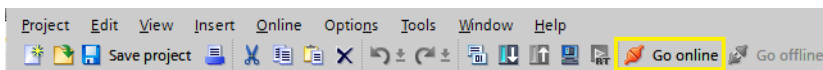

Figure 16: Go online

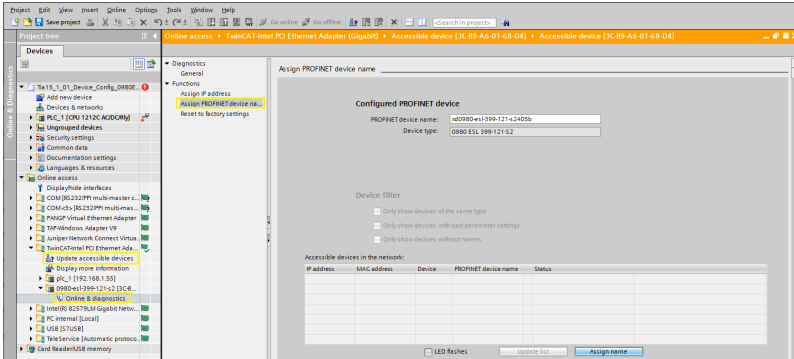

Figure 17: Online mode

5. Enter the same device name as configured in the offline project:

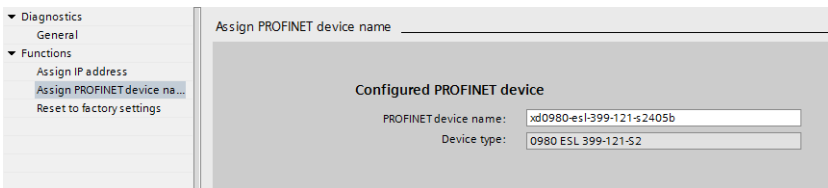

Figure 18: Assign device name

6.4.2 Configuring the IO-Link channels

By default, all channels are pre-configured as inactive according to the IO-Link specification.

Module	Rack	Slot	I address	Q address	Type	Article number
0980-ESL-399-121-S2	0	0: PR...			0980 ESL 399-121-...	935 021 004
PN-IO	0	0: PR...			0980-ESL-399-121-...	
IO-Link Master_1	0	1: IO ...			IO-Link Master	
Status/Control Module	0	1: IO ...	1...2	1...2	Status/Control Mod...	
Inactive (A/B)	0	1: IO ...	3		Inactive (A/B)	
Inactive (A/B)_1	0	1: IO ...	4		Inactive (A/B)	
Inactive (A/B)_2	0	1: IO ...	5		Inactive (A/B)	
Inactive (A/B)_3	0	1: IO ...	6		Inactive (A/B)	
Inactive (A/B)_4	0	1: IO ...	7		Inactive (A/B)	
Inactive (A/B)_5	0	1: IO ...	8		Inactive (A/B)	
Inactive (A/B)_6	0	1: IO ...	9		Inactive (A/B)	
Inactive (A/B)_7	0	1: IO ...	10		Inactive (A/B)	

Figure 19: Channels pre-configuration

The configurations of the IO-Link channels (C/Q or Ch. A/Pin 4 of the IO-port) in the sub-slots 2 - 9 (port X1 of the device is equivalent to sub-slot 2, ..., port X8 of the device is equivalent to sub-slot 9) are flexibly definable.

The input and output addresses defined in the device overview can be changed.

6.4.2.1 Deleting the configuration of a specified IO-Link channel

1. To delete an IO-Link channel, select the desired IO-Link channel(s) in **Device overview**:

Module	Rack	Slot	I address	Q address	Type	Article number
0980-ESL-399-121-S2	0	0: PR...			0980 ESL 399-121-...	935 021 004
PN-IO	0	0: PR...			0980-ESL-399-121-...	
IO-Link Master_1	0	1: IO ...			IO-Link Master	
Status/Control Module	0	1: IO ...	1...2	1...2	Status/Control Mod...	
Inactive (A/B)	0	1: IO ...	3		Inactive (A/B)	
Inactive (A/B)_1	0	1: IO ...	4		Inactive (A/B)	
Inactive (A/B)_2	0	1: IO ...	5		Inactive (A/B)	
Inactive (A/B)_3	0	1: IO ...	6		Inactive (A/B)	
Inactive (A/B)_4	0	1: IO ...	7		Inactive (A/B)	
Inactive (A/B)_5	0	1: IO ...	8		Inactive (A/B)	
Inactive (A/B)_6	0	1: IO ...	9		Inactive (A/B)	
Inactive (A/B)_7	0	1: IO ...	10		Inactive (A/B)	

Figure 20: Device overview

2. Right click and then select the **Delete** option in the menu that appears:

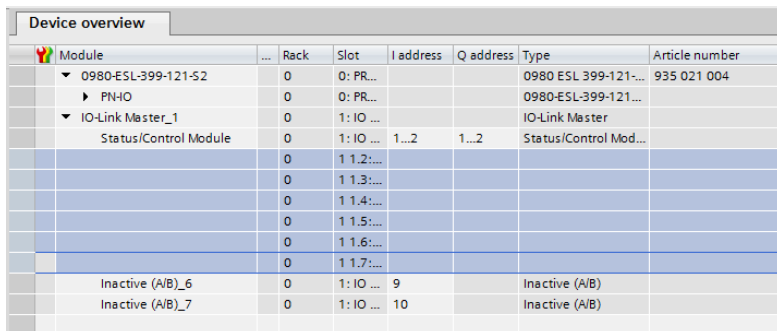

Device overview							
Module	Rack	Slot	I address	Q address	Type	Article number	
0980-ESL-399-121-S2	0	0: PR...			0980 ESL 399-121-...	935 021 004	
PN-IO	0	0: PR...			0980-ESL-399-121...		
IO-Link Master_1	0	1: IO ...			IO-Link Master		
Status/Control Module	0	1: IO ...	1...2	1...2	Status/Control Mod...		
	0	1 1.2:...					
	0	1 1.3:...					
	0	1 1.4:...					
	0	1 1.5:...					
	0	1 1.6:...					
	0	1 1.7:...					
	0	1: IO ...	9		Inactive (A/B)		
	0	1: IO ...	10		Inactive (A/B)		

Figure 21: Free IO-Link channel(s)

6.4.2.2 Creating an IO-Link channel configuration

The **Submodules** folder of the IO device inside the **Hardware catalog** shows all configurable options that can be selected:

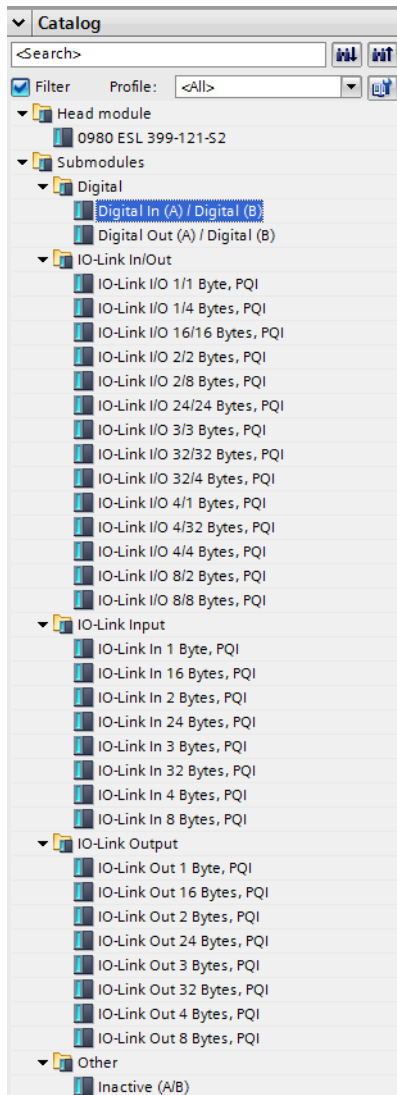

Figure 22: IO-Link channel configuration

Select the desired option, click and hold down the left mouse button to drag the configuration to a free IO-Link sub-slot:

Device overview								
Module	...	Rack	Slot	I address	Q address	Type	Article number	
▼ 0980-ESL-399-121-52		0	0: PR...			0980 ESL 399-121...	935 021 004	
▶ PN-IO		0	0: PR...			0980-ESL-399-121...		
▼ IO-Link Master_1		0	1: IO ...			IO-Link Master		
Status/Control Module		0	1: IO ...	1...2	1...2	Status/Control Mod...		
Digital In (A) / Digital (B)		0	1: IO ...	68		Digital In (A) / Digit...		
Digital Out (A) / Digital (B)		0	1: IO ...		64	Digital Out (A) / Dig...		
Digital In (A) / Digital (B)_1		0	1: IO ...	74		Digital In (A) / Digit...		
IO-Link I/O 4/4 Bytes, PQI		0	1: IO ...	69...73	65...68	IO-Link I/O 4/4 Byte...		
Digital In (A) / Digital (B)_2		0	1: IO ...	75		Digital In (A) / Digit...		
IO-Link I/O 4/4 Bytes, PQL...		0	1: IO ...	76...80	69...72	IO-Link I/O 4/4 Byte...		
Inactive (A/B)_6		0	1: IO ...	9		Inactive (A/B)		
Inactive (A/B)_7		0	1: IO ...	10		Inactive (A/B)		

The following options are available for the IO-Link C/Q channel (Ch. A/Pin 4):

Digital In (DI)

In this mode the channel operates as a digital input. The IO-Link Master does not try to establish communication to a connected (IO-Link) Device.

Digital Out (DO)

In this mode, the channel operates as a digital output. It is impossible at any time to communicate with the connected device. The “Digital Out” option for IO-Link C/Q channel (Ch. A/Pin 4) is not available for the 0980 ESL 3x8-121 device.

Inactive

This mode should be selected if the A-channel of Type A and Type B ports and the B-channel of Type A ports (port 1-4) are not used. The L+ power supply (pin 1) of the port is disabled in this case. For Type B ports (port 5-8) the function of the B-channel must be configured separately over the Status/Control Module (DO Mode for Ch. B, e.g. *Inactive*, *Digital Output* or *Auxiliary Power*).

IO-Link ...

In this mode (IO-Link communication mode), the process data from or to the device are exchanged over a communication link. Depending on the port configuration, the IO-Link Master automatically starts communicating with the connected IO-Link Device, taking into account the baud rate. Additionally, this mode offers the option of parameterizing the IO-Link Device. Configuration modules with data lengths of 1-33 bytes for inputs and 1-32 bytes for outputs are available. If no suitable configuration module is available for the device, the next larger data length must be selected. After the first configuration of the device, this port configuration will be stored non-volatile on the IO-Link Master. This means that with the next power-up the IO-Port will be pre-configured with these settings before the controller will send a new port configuration. The sensor supply (IO-Port Pin 1) and the auxiliary supply (IO-Port Pin 2) will be powered up directly depending on the last active configuration. A configuration telegram of the PN-Controller is not being required. The IO-data remain inactive until a new configuration is received after the power-up of the IO-Link Master.

6.4.3 Parameterization of the IO-Link channels

In the device configuration mode, click on the corresponding IO-Link sub-slot in the **Device overview** and select the **Module parameters** for setting the following parameters:

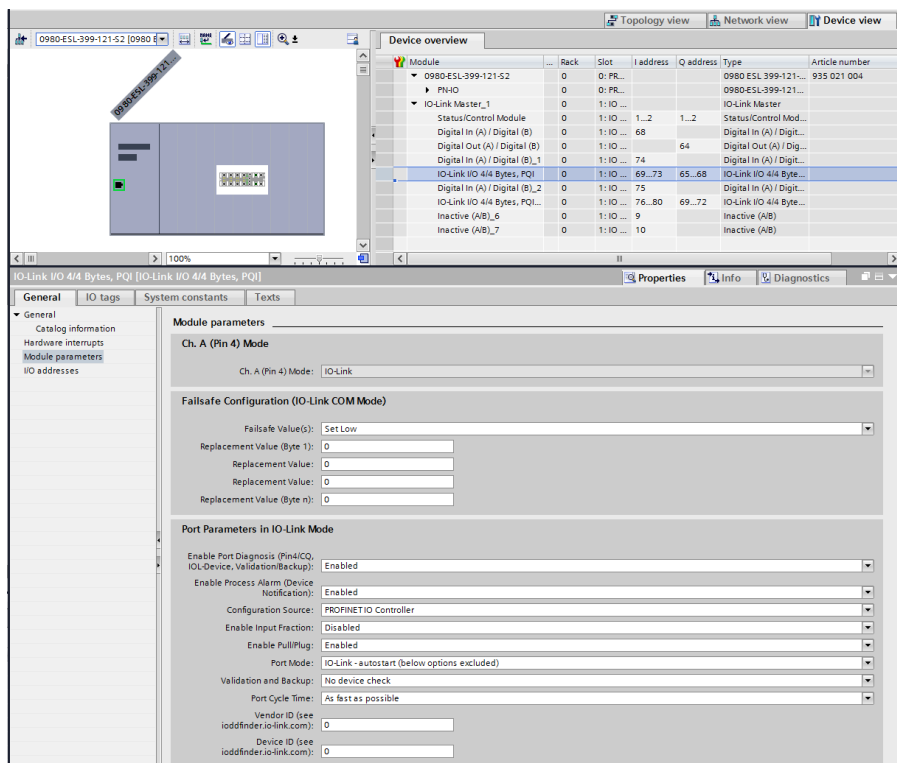

The screenshot shows the Siemens TIA Portal interface. The top window, titled 'Device overview', displays a table of modules and their parameters. The bottom window, titled 'Module parameters', shows the configuration options for the selected IO-Link module.

Module	Rack	Slot	I address	Q address	Type	Article number
0980-ESL-399-121-52	0	0: PR...			0980-ESL-399-121...	935 021 004
▶ PIN-IO	0	0: PR...			0980-ESL-399-121...	
▼ IO-Link Master_1	0	1: IO ...			IO-Link Master	
▶ Status/Control Module	0	1: IO ...	1...2	1...2	Status/Control Mod...	
Digital In (A) / Digital (B)	0	1: IO ...	68		Digital In (A) / Digit...	
Digital Out (A) / Digital (B)	0	1: IO ...		64	Digital Out (A) / Dig...	
Digital In (A) / Digital (B)_1	0	1: IO ...	74		Digital In (A) / Digit...	
IO-Link I/O 4/4 Bytes, PQI	0	1: IO ...	69...73	65...68	IO-Link I/O 4/4 Byte...	
Digital In (A) / Digital (B)_2	0	1: IO ...	75		Digital In (A) / Digit...	
IO-Link I/O 4/4 Bytes, PQI...	0	1: IO ...	76...80	69...72	IO-Link I/O 4/4 Byte...	
Inactive (AB)_6	0	1: IO ...	9		Inactive (AB)	
Inactive (AB)_7	0	1: IO ...	10		Inactive (AB)	

The bottom window, 'Module parameters', shows the following configuration options:

- General** (selected): Catalog information, Hardware interrupts, **Module parameters**, IO addresses.
- Module parameters**
 - Ch. A (Pin 4) Mode**: Ch. A (Pin 4) Mode: IO-Link
 - Failsafe Configuration (IO-Link COM Mode)**
 - Failsafe Value(s): Set Low
 - Replacement Value (Byte 1): 0
 - Replacement Value: 0
 - Replacement Value: 0
 - Replacement Value (Byte n): 0
 - Port Parameters in IO-Link Mode**
 - Enable Port Diagnosis (Pin4/CQ, IOL-Device, Validation/Backup): Enabled
 - Enable Process Alarm (Device Notification): Enabled
 - Configuration Source: PROFINET IO Controller
 - Enable Input Fraction: Disabled
 - Enable Pull/Plug: Enabled
 - Port Mode: IO-Link - autostart (below options excluded)
 - Validation and Backup: No device check
 - Port Cycle Time: As fast as possible
 - Vendor ID (see ioddfinder.io-link.com): 0
 - Device ID (see ioddfinder.io-link.com): 0

Figure 23: Parameter of the IO-Link channels

6.4.3.1 Failsafe Configuration

The following values are selectable (for output data only):

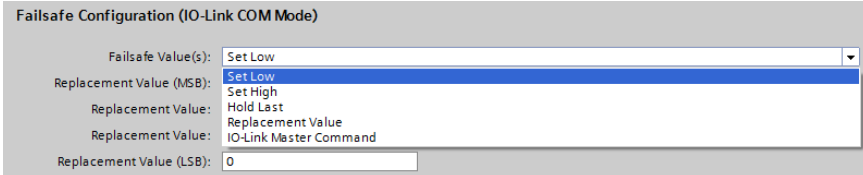

Failsafe Configuration (IO-Link COM Mode)

Failsafe Value(s): Set Low

Replacement Value (MSB): Set Low

Replacement Value: Set High

Replacement Value: Hold Last

Replacement Value: Replacement Value

Replacement Value: IO-Link Master Command

Replacement Value (LSB): 0

Figure 24: Failsafe Configuration

Set Low

All bits of the output data with a value of **0** are transmitted to the IO-Link Device. (Default setting)

Set High

All bits of the output data with a value of **1** are transmitted to the IO-Link Device.

Hold Last

The last valid output value received by the control unit is continuously and cyclically transmitted to the IO-Link Device.

For proper *Hold Last* behavior the appropriate IOL-Device parameters must also be set to *Hold Last*.

Replacement Value

If this option is selected, the value entered in the **Replacement Value** input field described below is continuously and cyclically transmitted to the IO-Link Device.

IO-Link Master Command

The **IO-Link Master Command** option allows the use of IO-Link-specific mechanisms for valid/invalid output process data. Thus, the device itself determines the behavior.

Replacement Value

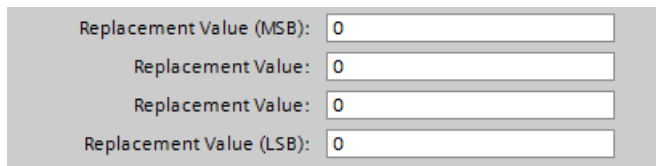

The image shows a configuration window with a grey background. It contains four rows, each with a label and a text input field. The labels are 'Replacement Value (MSB):', 'Replacement Value:', 'Replacement Value:', and 'Replacement Value (LSB):'. Each input field contains the number '0'.

Figure 25: Replacement Value

If the "Fail Safe Value(s)" option is set to "Replacement Value", the substitute value(s) entered in this/these input field(s) is/are used.

The value must be entered as a decimal value. Depending on the configured data length, the values must be entered as bytes (0-255) or word decimal values (0-65535) in the order shown.

- ▶ MSB = high order byte (UINT8)
- ▶ LSB = low order byte (UINT8)
- ▶ MSW = high order word (UINT16)
- ▶ LSW = low order word (UINT16)

6.4.3.2 IO-Link Port Parameters

Enable Port Diagnostics

The IO-Link Master port diagnostics and the IO-Link Device alarms can be enabled or disabled over this option.

This affects only the diagnostics related to the IO-Link channel (pin4) of the IO port.

Default: Enabled

Enable Process Alarm (Device Notifications)

The IO-Link Device alarm notifications can be enabled or disabled with this option. Disabled means, that all notification alarm types from every IO-Link Device will be suppressed by the IO-Link Master. They will be not forwarded by PROFINET alarms to the controller.

Default: Enabled

Configuration Source

PROFINET IO Controller:

The IO-Link Master port configuration will be assigned by the PROFINET IO Controller.

Port and Device Configuration Tool:

(Not supported yet)

The IO-Link Master port configuration will be assigned by an external IO-Link Port and Device Configuration Tool.

Default: PROFINET IO Controller

Enable Input Fraction

If the user configures a sub-slot module with less than the real input data of the device, the IO-Link Master sends as much as possible IO-Link Device input bytes to the PLC inclusive the PQI byte of the sub-slot module. As a consequence, only "0" up to (Device Input Length - 1) octets of the input data of the device can be mapped to the PROFINET process input data of the

IO-Link Master. If this option is disabled, a data length mismatch alarm is active in the case of a mismatching input data length. In case of an output data mismatch, a process data mismatch diagnosis will be generated independently of the selected "Enable Input Fraction" setting.

Default: Disabled

Enable Pull/Plug

Enables or Disables Pull/Plug alarms of an IOL-Device (Add/Remove Submodule). A failure or the return of an IO-Link Device can be mapped via PROFINET Plug or Pull alarms. This mapping is independent from any phase such as power-up or start-up.

Plug Alarms:

- “Ready to Operate” (IOL-Device is ready)
- “COM Fault” (incorrect device or other problems) – IOL-Device started but not ready due to fault.

Pull Alarms:

- “COM Fault” (No IOL-Device)

In the “Disabled” option, channel diagnostics will be generated in case of losing an IO-Link Device.

Default: Enabled

Port Mode – options

Deactivated:

With the "Deactivated" option, an IO-Link port can be configured for later use. No diagnostics are generated if the IO-Link Device is not connected.

IO-Link - Autostart:

With the “Plug&Play” option no explicit port configuration is needed. Basic assignments such as *Validation and Backup* (Inspection Level), *Port Cycle Time*, *Vendor ID* and *Device ID* are not required.

IO-Link - Manual:

Explicit port configuration possible for *Validation and Backup* (Inspection Level), *Port Cycle Time*, *Vendor ID* and *Device ID*. These Parameters are GSD based and can be set over PROFINET engineering system.

Default: IO-Link Autostart

Overview and dependencies of the *Port Mode* configuration type:

Feature	IO-Link - autostart	IO-Link - manual (GSD)
Access on Process Data (PD)	Yes	Yes
Diagnostics of port & device	Yes	Yes
I&M data (IM0) access	Yes	Yes
Device check (consolidated/real)	No	Yes
Backup & Restore	No	Yes
Device parameterization (PDCT)	No	No
TMG TE GmbH Device Tool V5	Yes	Yes
Commissioning (online)	No	No

Table 7: Overview, port mode config types

Validation and Backup (Port Mode "IO-Link - manual" required)

No IOL-Device check:

No check of connected *Vendor ID* or *Device ID* and no *Backup and Restore* support of the IOL-Master parameter server

Type compatible IOL-Device(V1.0):

Type compatible according IO-Link specification V1.0

Type compatible IOL-Device (V1.1):

Type compatible according IO-Link specification V1.1, check of *Vendor ID* and *Device ID* by IOL-Master

Type compatible IOL-Device (V1.1) with Backup & Restore:

Type compatible according IO-Link specification V1.1, check of *Vendor ID* and *Device ID* by IOL-Master with

Backup and Restore. For *Backup and Restore* function, the connected IOL-Device must be type compatible.

Backup (device to master):

A Backup (Upload / from IOL-Device to IOL-Master) is performed when an IO-Link Device is connected and the master does not have any valid data. The parameter data read are permanently stored on the master.

If parameter data are changed on the device during runtime, the device parameter stored on the master can be updated using the ParamDownloadStore (Index 0x0002, Subindex 0x00, Value 0x05) command. This command sets the DS_UPLOAD_REQ flag on the device, and thus IOL-Master executes an upload from IOL-Device.

For each new connection to an IO-Link Device, the master compares the stored parameter data with the device data. If the function is not locked on the device (*Parameter storage* locked), the master downloads the stored data to the device in case of detected differences.

With the *Backup* function, the IO-Link Master can be replaced.

Restore (master to device):

Parameter data can only be transferred to an IO-Link Device if they exist on the IOL-Master parameter server and are usable for the device. When an IOL-Device is connected, the master compares the stored parameter data with the IOL-Device data. If the function is not locked on the device (*Parameter storage* locked), the master downloads the stored data to the device in case of detected differences.

If the master does not have a device parameter set stored, nothing happens. With the *Restore* function, the IO-Link Device can be replaced.

Default: No IOL-Device check

Action	IO-Link Master State	IO-Link Device State
Backup	Invalid Data (Or Cleared)	Upload flag active (Valid Data)
Backup	Invalid Data (Or Cleared)	Upload flag not active & Valid Data
Backup	Valid Data	Upload flag active & Valid Data
Restore	Valid Data	Upload flag not active (Data Equal)



Attention: An IO-Link Device sets the “upload flag” self-dependent, if parameter were written in block mode to the IO-Link Device.

Port Cycle Time (Port Mode "IO-Link - manual" required)

As fast as possible:

The IO-Link Master uses the max. supported IOL-Device update cycle time limited by the max. supported IOL-Master cycle time for the cyclic IO data update between IOL-Master and IOL-Device.

1.6, 3.2, 4.8, 8, 20.8, 40, 80, 120 ms:

The cycle time can be set manually to the provided options. This option can be used e.g. for IOL-Device modules which are connected over inductive couplers. Inductive couplers are normally the bottleneck in the update cycle time between IOL-Master and IOL-Device. In this case, please refer to the data sheet of the inductive coupler.

Default: As fast as possible

Vendor ID (Port Mode "IO-Link - manual" required)

The Vendor ID of the connected IOL-Device used can be entered as a decimal value [0 ... 65535] and will be in used in dependency of the Validation and Backup settings for the validation of the type compatibility.

Default: 0

Device ID (Port Mode "IO-Link - manual" required)

The *Device ID* of the connected IOL-Device can be entered as a decimal value [0 ... 65535] and will be in used in dependency of the *Validation and Backup* settings for the validation of the type compatibility.

Default: 0

6.4.4 Parameterization of the Status/Control Module

Device overview							
Module	...	Rack	Slot	I address	Q address	Type	Article number
▼ 0980-ESL-399-121-52		0	0: PR...			0980 ESL 399-121-52	935 021 004
▶ PN-IO		0	0: PR...			0980-ESL-399-121-52	
▼ IO-Link Master_1		0	1: IO ...			IO-Link Master	
Status/Control Module		0	1: IO ...	1...2	1...2	Status/Control Module	
Digital In (A) / Digital (B)		0	1: IO ...	68		Digital In (A) / Digital (B)	
Digital Out (A) / Digital (B)		0	1: IO ...		64	Digital Out (A) / Digital (B)	
Digital In (A) / Digital (B)_1		0	1: IO ...	74		Digital In (A) / Digital (B)	
IO-Link I/O 4/4 Bytes, PQI		0	1: IO ...	69...73	65...68	IO-Link I/O 4/4 Bytes, PQI	
Digital In (A) / Digital (B)_2		0	1: IO ...	75		Digital In (A) / Digital (B)	
IO-Link I/O 4/4 Bytes, PQI...		0	1: IO ...	76...80	69...72	IO-Link I/O 4/4 Bytes, PQI	
Inactive (A/B)_6		0	1: IO ...	9		Inactive (A/B)	
Inactive (A/B)_7		0	1: IO ...	10		Inactive (A/B)	

Figure 26: Status/Control Module

Parameters within the Status/Control Module:

Module parameters
General Device Settings
General Diagnosis Settings
Failsafe Configuration (DO Mode)
Surveillance Timeout Configura...
Digital Input Logic
Digital I/O mode for Ch. B
Module failure

Figure 27: Parameters Status/Control Module

The Status/Control Module in slot 1/sub-slot 1 is pre-configured for each LioN-P IOL-Master. It consists of 2 bytes of input and 2 bytes of output data for the digital IO data. The bit assignments are described in Section [Bit assignment](#) on page 97.

The Status/Control Module can also be used to perform all parameterizations that do not affect ports in IO-Link mode.

The following parameterizations are possible after clicking on the subitems under the **Module parameters**:

6.4.4.1 General Device Settings

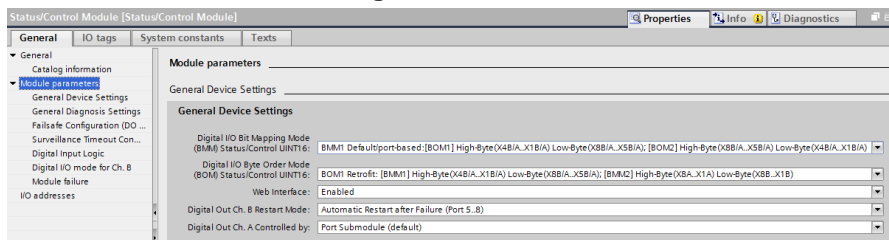

Figure 28: General Device Settings

Digital-IO Bit Mapping Mode (BMM)

With this parameter the bit mapping of the I/O bits can be selected.

BMM1 (Default Mapping):

In the “port-based” Bit Mapping Mode 1 (BMM1), the A-channel bits (C/Q, Ch.A(Pin 4) and B-Channel bit are transmitted alternately in ascending order for all ports.

Mapping for **BMM1 + BOM1** (for Byte Order Mapping 1, see next parameter):

Status/Control	Bit 7	Bit 6	Bit 5	Bit 4	Bit 3	Bit 2	Bit 1	Bit 0
UINT16 High-B	X4B	X4A	X3B	X3A	X2B	X2A	X1B	X1A
UINT16 Low-B	X8B	X8A	X7B	X7A	X6B	X6A	X5B	X5A

Mapping for **BMM1 + BOM2** (for Byte Order Mapping 2, see next parameter):

Status/Control	Bit 7	Bit 6	Bit 5	Bit 4	Bit 3	Bit 2	Bit 1	Bit 0
UINT16 High-B	X8B	X8A	X7B	X7A	X6B	X6A	X5B	X5A
UINT16 Low-B	X4B	X4A	X3B	X3A	X2B	X2A	X1B	X1A

BMM2 (Retrofit Mapping):

In the “pin-based” Bit Mapping Mode 2 (BMM2) all ascending A-channel bits (C/Q, Ch.A/Pin 4) and all ascending B-channel bits (Ch.B/Pin 2) are transmitted in consecutively.

Mapping for **BMM2 + BOM1** (for Byte Order Mapping 1, see next parameter):

Status/Control	Bit 7	Bit 6	Bit 5	Bit 4	Bit 3	Bit 2	Bit 1	Bit 0
UINT16 High-B	X8A	X7A	X6A	X5A	X4A	X3A	X2A	X1A
UINT16 Low-B	X8B	X7B	X6B	X5B	X4B	X3B	X2B	X1B

Mapping for **BMM2 + BOM2** (for Byte Order Mapping 2, see next parameter):

Status/Control	Bit 7	Bit 6	Bit 5	Bit 4	Bit 3	Bit 2	Bit 1	Bit 0
UINT16 High-B	X8B	X7B	X6B	X5B	X4B	X3B	X2B	X1B
UINT16 Low-B	X8A	X7A	X6A	X5A	X4A	X3A	X2A	X1A

Digital-IO Byte Order Mode (BOM)

With this parameter the byte order of the Status/Control bytes can be selected.

BOM1 (Retrofit, Default Mapping):

For BMM1 the ports X4-X1 bits are mapped to the Status/Control High Byte.

For BMM2 the A-channels bits of port X8-X1 bits are mapped to the Status/Control High Byte.

Mapping for **BOM1 + BMM1** (for Bit Mapping Mode 1, see previous parameter):

Status/Control	Bit 7	Bit 6	Bit 5	Bit 4	Bit 3	Bit 2	Bit 1	Bit 0
UINT16 High-B	X4B	X4A	X3B	X3A	X2B	X2A	X1B	X1A
UINT16 Low-B	X8B	X8A	X7B	X7A	X6B	X6A	X5B	X5A

Mapping for **BOM1 + BMM2** (for Bit Mapping Mode 2, see previous parameter):

Status/Control	Bit 7	Bit 6	Bit 5	Bit 4	Bit 3	Bit 2	Bit 1	Bit 0
UINT16 High-B	X8A	X7A	X6A	X5A	X4A	X3A	X2A	X1A
UINT16 Low-B	X8B	X7B	X6B	X5B	X4B	X3B	X2B	X1B

BOM2 (New Standard):

For BMM1 the ports X8-X5 bits are mapped to the Status/Control High Byte.

For BMM2 the B-channels bits of port X8-X1 bits are mapped to the Status/Control High Byte.

Mapping for **BOM2 + BMM1** (for Bit Mapping Mode 1, see previous parameter):

Status/Control	Bit 7	Bit 6	Bit 5	Bit 4	Bit 3	Bit 2	Bit 1	Bit 0
UINT16 High-B	X8B	X8A	X7B	X7A	X6B	X6A	X5B	X5A
UINT16 Low-B	X4B	X4A	X3B	X3A	X2B	X2A	X1B	X1A

Mapping for **BOM2 + BMM2** (for Bit Mapping Mode 2, see previous parameter):

Status/Control	Bit 7	Bit 6	Bit 5	Bit 4	Bit 3	Bit 2	Bit 1	Bit 0
UINT16 High-B	X8B	X7B	X6B	X5B	X4B	X3B	X2B	X1B
UINT16 Low-B	X8A	X7A	X6A	X5A	X4A	X3A	X2A	X1A

Web Interface

The Web interface access can be set to "Enabled" or "Disabled" with this parameter. In case of the "Disabled" setting, the Web pages are not reachable.

Default: Enabled

Digital Output Restart Mode

Automatic Restart after Failure:

With this parameter the digital output restart behavior for Ch. B outputs of Port 5 - 8 (60mm variants only) can be set.

In case of detecting an output short circuit or overload, the output will be switched off by the IO-Link Master. However, after a time delay, the output will automatically be turned on again for checking if the overload or short circuit condition is active.

Restart after Output Reset:

In case of detecting an output short circuit or overload, the output will be switched off by the IO-Link Master.

The output will not be set automatically. Before the output can be turned on again, it must be logically reset by the PLC.

Default: Automatic Restart after Failure

Digital Out Ch. A Controller

Port Submodule:

For controlling the digital A-channels, the output **Byte 1/ Bit 0** of the appropriate sub-slot module must be used.

Status/Control Module:

In this case, the digital A-channel outputs can be controlled by the Status/Control Module output bits. The digital output can be controlled only by one data source.

Default: Port Submodule

6.4.4.2 General Diagnostic Settings

General Diagnosis Settings	
Report UAux supply voltage fault alarms:	Disabled
Report Ch.B/Pin2 DO fault without UAux:	Enabled

Report UAux supply voltage fault alarms

The U_{Aux} supply voltage fault alarm can be enabled or disabled with this parameter.

Default: Disabled



Attention: "Report U_{Aux} supply voltage fault" is disabled in the default setting to avoid diagnostic messages due to switching the supply voltage on or off later on.

Report Ch.B/Pin2 DO fault without UAux

The diagnosis of the Ch. B/Pin 2 digital outputs can be configured in dependency of the U_{Aux} status.

Default: Enabled

6.4.4.3 Failsafe Configuration (DO-Mode)

The device supports a failsafe function for the channels used as digital outputs. During configuration of the devices, the status of the PROFINET IO device outputs can be defined after an interruption, or loss of communication on the PROFINET IO network.

The following options can be selected:

- ▶ Set Low - the output channel is disabled and/or the output bit set to **0**.
- ▶ Set High - the output channel is enabled and/or the output bit set to **1**.
- ▶ Hold last – the last output state is kept.

Default: Set Low

6.4.5 Surveillance Timeout Configuration (LioN-P 60 devices)

For LioN-P 60 devices, the separate power supply 2L+ (U_{Aux}), which is available on type B IO-Link channels (Ch. B/Pin 2), ports 5-8, can also be configured as an additional digital output (subitem: **Digital-IO mode for Ch. B/Pin 2**). This gives you the option of switching the power supply like a digital output.

The firmware of the modules allows you to configure a delay time before output status monitoring is enabled for this special use case.

The delay time is referred to as the "Surveillance-Timeout" and can be configured for each output channel. The delay time begins with a rising edge of the output control bit. After this time has elapsed, the output is monitored, and error states are reported by diagnostics.

The "Surveillance-Timeout" parameter can be set from 0 to 255 ms. The default value for this parameter is 80 ms. When an output channel is in static state, i.e., when the channel is permanently switched on or off, the typical value is 5 ms.

Default: 80 ms

6.4.6 Digital Input Logic

This parameter can be used to configure the logic of the channels used as digital inputs.

NO (Normally Open)

A non-damped sensor has an open switching output (low signal) in this case. The device input detects a low signal and returns a 0 to the control unit.

The LED of the channel shows the physical input state.

NC (Normally Closed)

A non-damped sensor has a closed switching output (high signal) in this case. The device input detects a high signal, inverts the signal, and returns a 0 to the control unit.

The channel LED displays, independent of the setting, the physical input state.

Default: NO (Normally Open) for all channels

6.4.7 Digital-IO mode for Ch. B/Pin 2

6.4.7.1 Digital-IO mode for Ch. B/Pin 2 (LioN-P 30 devices)

The Type B IO-Link ports of the LioN-P 30 devices have a fixed configuration:

Port 1 – 4: Digital Input (DI)

Port 5 – 8: Auxiliary Power (Type B IO-Link port)

6.4.7.2 Digital-IO mode for Ch. B/Pin 2 (LioN-P 60 devices)

The Type B IO-Link ports, ports 5 – 8 on the LioN-P 60 devices, can be parameterized as follows:

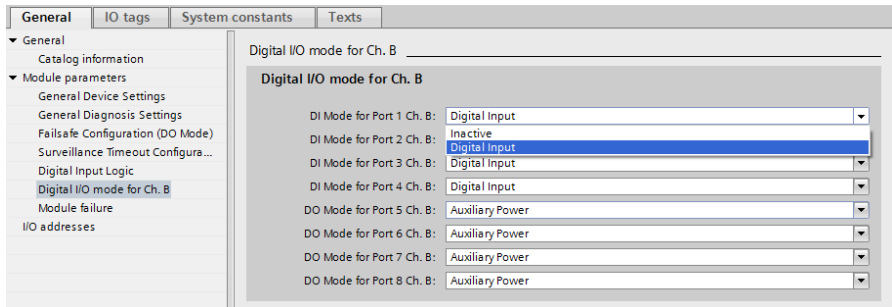

Figure 29: Port 1 – 4: “Inactive” or “Digital Input”

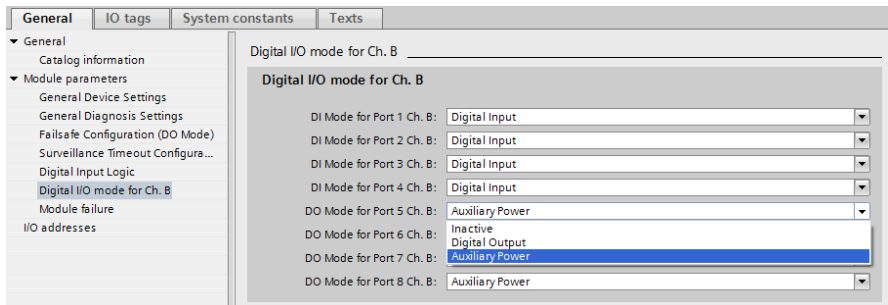

Figure 30: Port 5 – 8: “Inactive”, “Digital Input” or “Auxiliary Power”

Inactive

No function of Ch. B

Auxiliary Power (IO-Link Type B)

In this mode, Pin 2 and Pin 5 of the Type B IO-Link ports, ports 5 – 8, act as an auxiliary voltage output. The auxiliary voltage is fed from the module's U_{Aux} supply input. The auxiliary voltage output cannot be controlled. The Auxiliary Power will be signaled by the white port LED.

Digital Output (DO)

In this mode, Ch. B/Pin 2 of the Type B IO-Link ports, ports 5 – 8, can be used as a digital output. The control bits are transferred by the control unit to the device within the Status/Control Module. A **Surveillance-Timeout** can be parameterized for the outputs (tab **Surveillance Timeout Configuration**).

Default:

Port 1 – 4: Digital Input

Port 5 – 8: Auxiliary Power Supply (Type B IO-Link ports)

6.5 IO-Link Device Parameterization

6.5.1 SIEMENS IO-Link library

The SIEMENS "IO_LINK_DEVICE" function block (FB50001) can both acyclically read and write parameters of an IOL-Device and read parameters, IO data and diagnostic data.

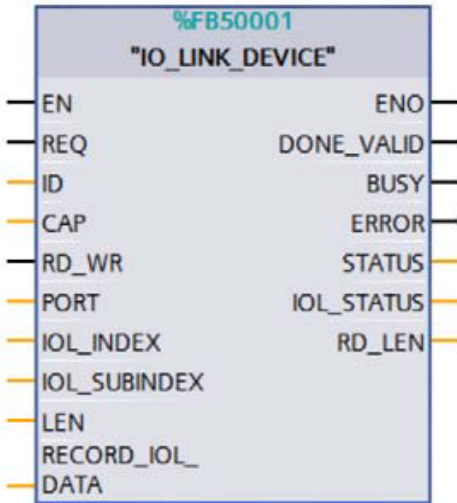

Figure 31: "IO_LINK_DEVICE" FB in STEP 7 V14 SP1

Service data are uniquely addressed via the index and the sub-index and can be accessed or written via the hardware identifier of the status/control module (ID) inputs, the client access point (CAP = 0xB400) and the corresponding IO-Link port (PORT: 1 - 8 for IO-Link ports).

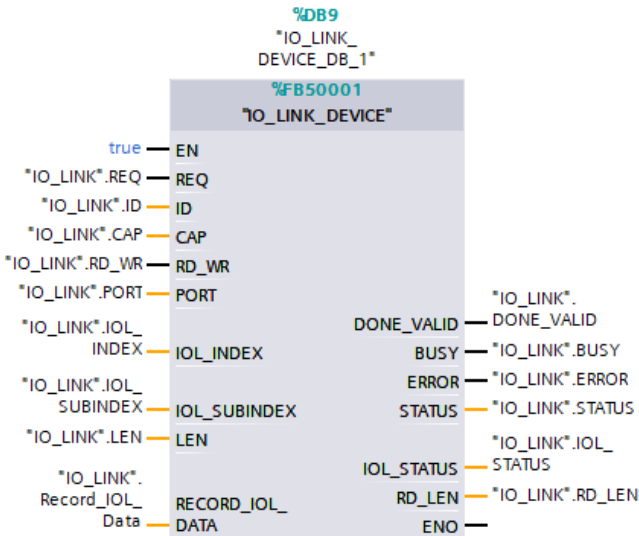

Figure 32: Service data (example)

6.5.1.1 SIEMENS function block FB50001 – read example

The following is a read example for an IOL-Device on port 4 with the value 24 at the application tag parameter **IOL_INDEX**. The Inputs and Outputs are in **DEC**. Only **RECORD_IOL_DATA** is in **HEX**. The read value here is "test" (= 74 / 65 / 73 / 74 in **HEX**).

Name	Data type	Start value	Monitor value	Retain	Accessible f...	Writa...	Visible in ...	Setpoint
1	Static							
2	REQ	Bool	false	TRUE				
3	ID	HW_IO	0	281				
4	CAP	Dint	0	46080				
5	RD_WR	Bool	false	FALSE				
6	PORT	Int	0	4				
7	IOL_INDEX	Int	0	24				
8	IOL_SUBINDEX	Int	0	0				
9	LEN	Int	0	0				
10	Record_IOL_Data	Array(0..231) of Byte						
11	Record_IOL_Data[0]	Byte	16#0	16#74				
12	Record_IOL_Data[1]	Byte	16#0	16#65				
13	Record_IOL_Data[2]	Byte	16#0	16#73				
14	Record_IOL_Data[3]	Byte	16#0	16#74				
15	Record_IOL_Data[4]	Byte	16#0	16#00				
16	Record_IOL_Data[5]	Byte	16#0	16#00				
17	Record_IOL_Data[6]	Byte	16#0	16#00				

Figure 33: Input data for the read request over FB50001 (read data in lines 11 - 14)

11	DONE_VALID	Bool	false	TRUE	<input type="checkbox"/>	<input checked="" type="checkbox"/>	<input checked="" type="checkbox"/>	<input checked="" type="checkbox"/>	<input type="checkbox"/>
12	BUSY	Bool	false	FALSE	<input type="checkbox"/>	<input checked="" type="checkbox"/>	<input checked="" type="checkbox"/>	<input checked="" type="checkbox"/>	<input type="checkbox"/>
13	ERROR	Bool	false	FALSE	<input type="checkbox"/>	<input checked="" type="checkbox"/>	<input checked="" type="checkbox"/>	<input checked="" type="checkbox"/>	<input type="checkbox"/>
14	STATUS	DWord	16#0	16#0000_0000	<input type="checkbox"/>	<input checked="" type="checkbox"/>	<input checked="" type="checkbox"/>	<input checked="" type="checkbox"/>	<input type="checkbox"/>
15	IOL_STATUS	DWord	16#0	16#0000_0000	<input type="checkbox"/>	<input checked="" type="checkbox"/>	<input checked="" type="checkbox"/>	<input checked="" type="checkbox"/>	<input type="checkbox"/>
16	RD_LEN	Int	0	4	<input type="checkbox"/>	<input checked="" type="checkbox"/>	<input checked="" type="checkbox"/>	<input checked="" type="checkbox"/>	<input type="checkbox"/>

Figure 34: Output data for the read request over FB50001

6.5.1.2 SIEMENS function block FB50001 – write example

The following is a write example for an IOL-Device on port 4 with the value 24 at the application tag parameter **IOL_INDEX**. The Inputs and Outputs are in *DEC*. Only **RECORD_IOL_DATA** is in *HEX*. The written value here is "help" (= 68 / 65 / 6c / 70 in *HEX*).

IO_LINK									
Name	Data type	Start value	Monitor value	Retain	Accessible f...	Writa...	Visible in ...	Setpoint	
1	Static								
2	REQ	Bool	false	TRUE	<input type="checkbox"/>	<input checked="" type="checkbox"/>	<input checked="" type="checkbox"/>	<input checked="" type="checkbox"/>	<input type="checkbox"/>
3	ID	HW_IO	0	281	<input type="checkbox"/>	<input checked="" type="checkbox"/>	<input checked="" type="checkbox"/>	<input checked="" type="checkbox"/>	<input type="checkbox"/>
4	CAP	Dint	0	46080	<input type="checkbox"/>	<input checked="" type="checkbox"/>	<input checked="" type="checkbox"/>	<input checked="" type="checkbox"/>	<input type="checkbox"/>
5	RD_HR	Bool	false	TRUE	<input type="checkbox"/>	<input checked="" type="checkbox"/>	<input checked="" type="checkbox"/>	<input checked="" type="checkbox"/>	<input type="checkbox"/>
6	PORT	Int	0	4	<input type="checkbox"/>	<input checked="" type="checkbox"/>	<input checked="" type="checkbox"/>	<input checked="" type="checkbox"/>	<input type="checkbox"/>
7	IOL_INDEX	Int	0	24	<input type="checkbox"/>	<input checked="" type="checkbox"/>	<input checked="" type="checkbox"/>	<input checked="" type="checkbox"/>	<input type="checkbox"/>
8	IOL_SUBINDEX	Int	0	0	<input type="checkbox"/>	<input checked="" type="checkbox"/>	<input checked="" type="checkbox"/>	<input checked="" type="checkbox"/>	<input type="checkbox"/>
9	LEN	Int	0	4	<input type="checkbox"/>	<input checked="" type="checkbox"/>	<input checked="" type="checkbox"/>	<input checked="" type="checkbox"/>	<input type="checkbox"/>
10	Record_IOL_Data	Array[0..231] of Byte			<input type="checkbox"/>	<input checked="" type="checkbox"/>	<input checked="" type="checkbox"/>	<input checked="" type="checkbox"/>	<input type="checkbox"/>
11	Record_IOL_Data[0]	Byte	16#0	16#68	<input type="checkbox"/>	<input checked="" type="checkbox"/>	<input checked="" type="checkbox"/>	<input checked="" type="checkbox"/>	<input type="checkbox"/>
12	Record_IOL_Data[1]	Byte	16#0	16#65	<input type="checkbox"/>	<input checked="" type="checkbox"/>	<input checked="" type="checkbox"/>	<input checked="" type="checkbox"/>	<input type="checkbox"/>
13	Record_IOL_Data[2]	Byte	16#0	16#6C	<input type="checkbox"/>	<input checked="" type="checkbox"/>	<input checked="" type="checkbox"/>	<input checked="" type="checkbox"/>	<input type="checkbox"/>
14	Record_IOL_Data[3]	Byte	16#0	16#70	<input type="checkbox"/>	<input checked="" type="checkbox"/>	<input checked="" type="checkbox"/>	<input checked="" type="checkbox"/>	<input type="checkbox"/>
15	Record_IOL_Data[4]	Byte	16#0	16#00	<input type="checkbox"/>	<input checked="" type="checkbox"/>	<input checked="" type="checkbox"/>	<input checked="" type="checkbox"/>	<input type="checkbox"/>
16	Record_IOL_Data[5]	Byte	16#0	16#00	<input type="checkbox"/>	<input checked="" type="checkbox"/>	<input checked="" type="checkbox"/>	<input checked="" type="checkbox"/>	<input type="checkbox"/>
17	Record_IOL_Data[6]	Byte	16#0	16#00	<input type="checkbox"/>	<input checked="" type="checkbox"/>	<input checked="" type="checkbox"/>	<input checked="" type="checkbox"/>	<input type="checkbox"/>

Figure 35: Input data for write request over FB50001

11	DONE_VALID	Bool	false	TRUE	<input type="checkbox"/>	<input checked="" type="checkbox"/>	<input checked="" type="checkbox"/>	<input checked="" type="checkbox"/>	<input type="checkbox"/>
12	BUSY	Bool	false	FALSE	<input type="checkbox"/>	<input checked="" type="checkbox"/>	<input checked="" type="checkbox"/>	<input checked="" type="checkbox"/>	<input type="checkbox"/>
13	ERROR	Bool	false	FALSE	<input type="checkbox"/>	<input checked="" type="checkbox"/>	<input checked="" type="checkbox"/>	<input checked="" type="checkbox"/>	<input type="checkbox"/>
14	STATUS	DWord	16#0	16#0000_0000	<input type="checkbox"/>	<input checked="" type="checkbox"/>	<input checked="" type="checkbox"/>	<input checked="" type="checkbox"/>	<input type="checkbox"/>
15	IOL_STATUS	DWord	16#0	16#0000_0000	<input type="checkbox"/>	<input checked="" type="checkbox"/>	<input checked="" type="checkbox"/>	<input checked="" type="checkbox"/>	<input type="checkbox"/>
16	RD_LEN	Int	0	0	<input type="checkbox"/>	<input checked="" type="checkbox"/>	<input checked="" type="checkbox"/>	<input checked="" type="checkbox"/>	<input type="checkbox"/>

Figure 36: Output data for write request over FB50001

6.5.2 SIEMENS WRREC and RDREC

The Reading and Writing Parameters from the PLC over the IOL-Master to the connected IOL-Device modules can also be handled by using the SIEMENS Function Blocks *SFB52/RDREC* and *SFB53/WRREC*.

6.5.2.1 Write sequence

The following figure shows the sequence of WRREC and RDREC calls for writing data:

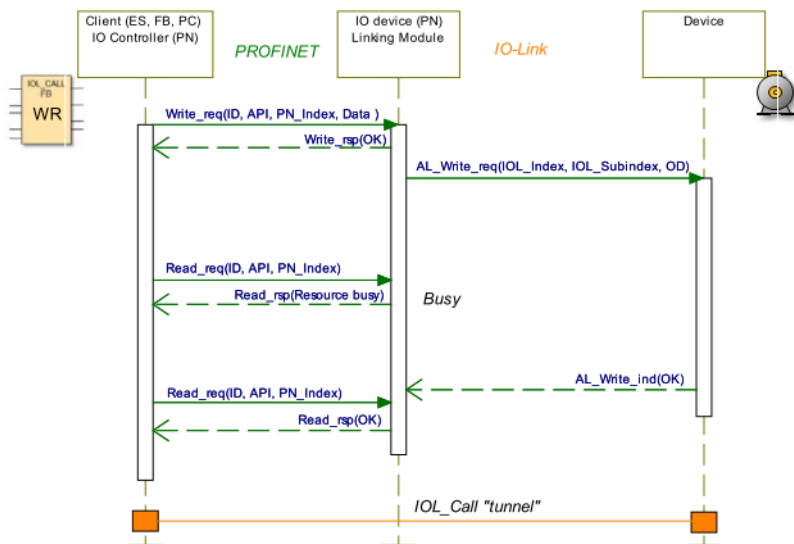

The following table shows the sequence with example data compared to the *FB50001* (former known as *IOL_Call*). The *FB50001* uses the WRREC and RDREC blocks internally:

FB50001 Call	WRREC				RDREC	RDREC Response		
ID (address proxy)	ID (address proxy)				ID (address proxy)			
CAP	PN_Index = 0xB400				PN_Index = 0xB400			
WR	Data Header	Function (fixed)	0x08	Unsigned8		Data Header	Function (fixed)	0x08
Port		Port	1-8	Unsigned8			Port	1-8
		FI_Index (Fixed)	0xFE4A	Unsigned16			FI_Index (Fixed)	0xFE4A
		Control/Status (→Write)	0x02	Unsigned8			Control/Status	0x00
IOL-Index		IOL-Index (0-32767; 65535)	0x...	Unsigned16			IOL-Index (0-32767; 65535)	0x...
IOLSubIndex		IOL-Sub-Index (0-255)	0x00	Unsigned8			IOL-Sub-Index (0-255)	0x00
IOL-Data		WR-Data					Data (opt. Error PDU)	

Table 8: WRREC ID

Unsigned16 values must be entered in Big Endian format for PROFINET.

Bit 7	Bit 6	Bit 5	Bit 4	Bit3	Bit2	Bit 1	Bit 0	Definition of Control octets
0	0	0	0	0	0	0	0	Cancel / Release IOL_CALL
0	0	0	0	0	0	0	1	IDLE Sequence
0	0	0	0	0	0	1	0	Write On-request Data or Port function
0	0	0	0	0	0	1	1	Read On-request Data
Other codings								Reserved

Table 9: Control Parameter

Bit 7	Bit 6	Bit 5	Bit 4	Bit3	Bit2	Bit 1	Bit 0	Definition of Status octets
0	0	0	0	0	0	0	0	Done / Transfer terminated
0	0	0	0	0	0	0	1	IDLE Sequence
1	0	0	0	0	0	0	0	IOL_Error PDU
Other codings								Reserved

Table 10: Status Parameter

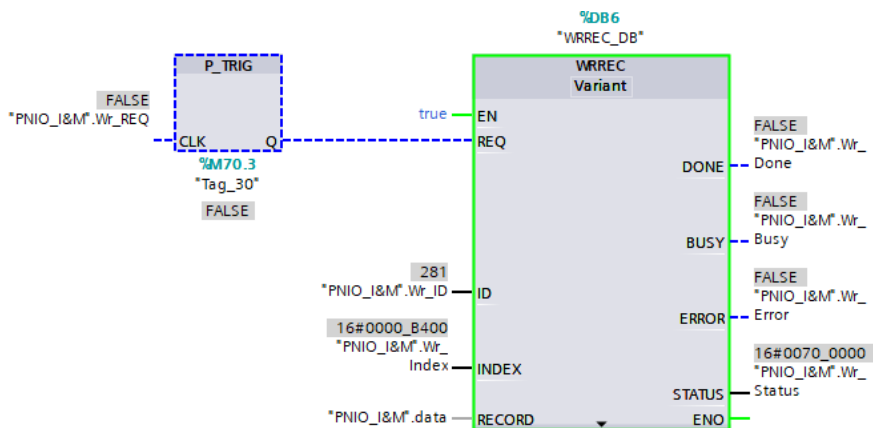

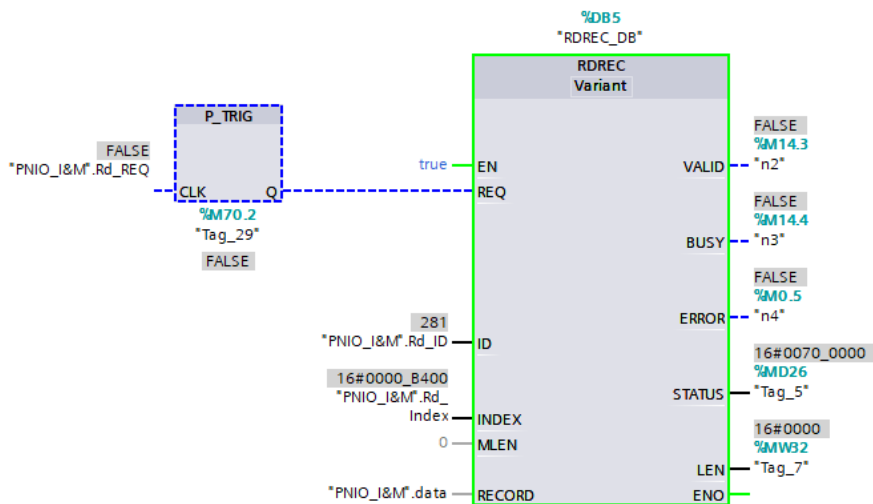

	Wr_REQ	Bool	false	FALSE
	Wr_Index	DWord	16#0	16#0000_B400
	Wr_ID	HW_IO	0	281
	Wr_Done	Bool	false	FALSE
	Wr_Busy	Bool	false	FALSE
	Wr_Error	Bool	false	FALSE
	Wr_Status	DWord	16#0	16#0000_0000
	Wr_Len	UInt	0	0
	▼ data	Array[0..39] of Byte		
	data[0]	Byte	16#0	16#08
	data[1]	Byte	16#0	16#05
	data[2]	Byte	16#0	16#FE
	data[3]	Byte	16#0	16#4A
	data[4]	Byte	16#0	16#02
	data[5]	Byte	16#0	16#00
	data[6]	Byte	16#0	16#18
	data[7]	Byte	16#0	16#00
	data[8]	Byte	16#0	16#54
	data[9]	Byte	16#0	16#45
	data[10]	Byte	16#0	16#53
	data[11]	Byte	16#0	16#54
	data[12]	Byte	16#0	16#00
	data[13]	Byte	16#0	16#00
	data[14]	Byte	16#0	16#00
	data[15]	Byte	16#0	16#00
	data[16]	Byte	16#0	16#00
	data[17]	Byte	16#0	16#00

Figure 37: Example of data before writing

☐	Wr_REQ	Bool	false	TRUE
☐	Wr_Index	DWord	16#0	16#0000_B400
☐	Wr_ID	HW_IO	0	281
☐	Wr_Done	Bool	false	FALSE
☐	Wr_Busy	Bool	false	FALSE
☐	Wr_Error	Bool	false	FALSE
☐	Wr_Status	DWord	16#0	16#0000_0000
☐	Wr_Len	UInt	0	0
☐	▼ data	Array[0..39] of Byte		
☐	data[0]	Byte	16#0	16#08
☐	data[1]	Byte	16#0	16#05
☐	data[2]	Byte	16#0	16#FE
☐	data[3]	Byte	16#0	16#4A
☐	data[4]	Byte	16#0	16#02
☐	data[5]	Byte	16#0	16#00
☐	data[6]	Byte	16#0	16#18
☐	data[7]	Byte	16#0	16#00
☐	data[8]	Byte	16#0	16#54
☐	data[9]	Byte	16#0	16#45
☐	data[10]	Byte	16#0	16#53
☐	data[11]	Byte	16#0	16#54
☐	data[12]	Byte	16#0	16#00
☐	data[13]	Byte	16#0	16#00
☐	data[14]	Byte	16#0	16#00
☐	data[15]	Byte	16#0	16#00
☐	data[16]	Byte	16#0	16#00
☐	data[17]	Byte	16#0	16#00

Figure 38: Example of data after writing

Name	Data type	Start value	Monitor value
▼ Static			
■ Rd_REQ	Bool	false	TRUE
■ Rd_Index	DWord	16#0	16#0000_B400
■ Rd_ID	HW_IO	0	281
■ Rd_Valid	Bool	false	FALSE
■ Rd_Busy	Bool	false	FALSE
■ Rd_Error	Bool	false	FALSE
■ Rd_Status	DWord	16#0	16#0000_0000
■ Rd_Len	UInt	0	0
▼ data	Array[0..39] of Byte		
■ data[0]	Byte	16#0	16#08
■ data[1]	Byte	16#0	16#05
■ data[2]	Byte	16#0	16#FE
■ data[3]	Byte	16#0	16#4A
■ data[4]	Byte	16#0	16#00
■ data[5]	Byte	16#0	16#00
■ data[6]	Byte	16#0	16#18
■ data[7]	Byte	16#0	16#00
■ data[8]	Byte	16#0	16#54
■ data[9]	Byte	16#0	16#45
■ data[10]	Byte	16#0	16#53
■ data[11]	Byte	16#0	16#54
■ data[12]	Byte	16#0	16#00
■ data[13]	Byte	16#0	16#00
■ data[14]	Byte	16#0	16#00
■ data[15]	Byte	16#0	16#00
■ data[16]	Byte	16#0	16#00
■ data[17]	Byte	16#0	16#00

Figure 39: Read data after writing

6.5.2.2 Read sequence

The following figure shows the sequence of WRREC and RDREC calls for reading data:

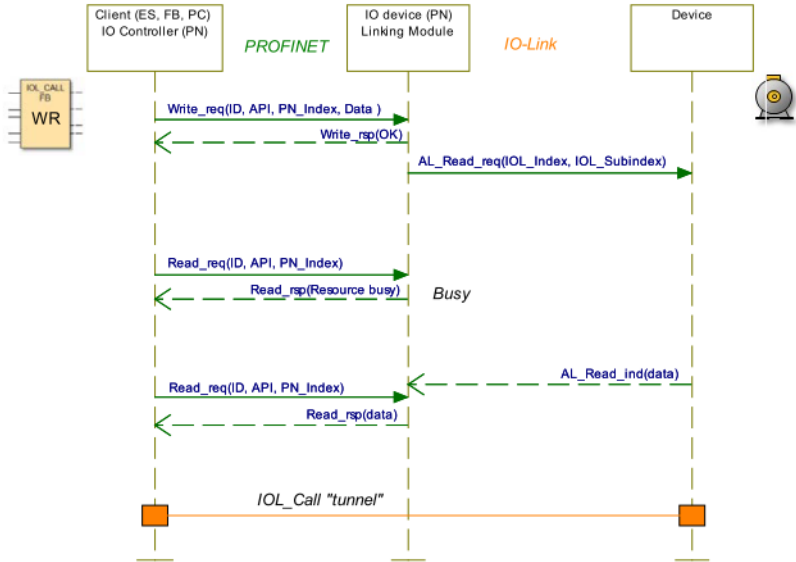

The following table shows the sequence with example data compared to the *FB50001* (former known as *IOL_Call*). The *FB50001* uses the WRREC and RDREC blocks internally:

FB50001 Call	WRREC				RDREC	RDREC Response		
ID (address proxy)	ID (address proxy)				ID (address proxy)			
CAP	PN_Index = 0xB400				PN_Index = 0xB400			
WR	Data Header	Function (fixed)	0x08	Unsigned8		Data Header	Function (fixed)	0x08
Port		Port	1-8	Unsigned8			Port	1-8
		FI_Index (Fixed)	0xFE4A	Unsigned16			FI_Index (Fixed)	0xFE4A
		Control/Status (→Read)	0x03	Unsigned8			Control/Status	0x00
IOL-Index		IOL-Index (0-32767; 65535)	0x...	Unsigned16			IOL-Index (0-32767; 65535)	0x...
IOLSubIndex		IOL-Sub-Index (0-255)	0x00	Unsigned8			IOL-Sub-Index (0-255)	0x00
IOL-Data		–					Data (opt. Error PDU)	

Table 11: RDREC ID

Unsigned16 values must be entered in Big Endian format for PROFINET.

Bit 7	Bit 6	Bit 5	Bit 4	Bit3	Bit2	Bit 1	Bit 0	Definition of Control octets
0	0	0	0	0	0	0	0	Cacncel / Release IOL_CALL
0	0	0	0	0	0	0	1	IDLE Sequence
0	0	0	0	0	0	1	0	Write On-request Data or Port function
0	0	0	0	0	0	1	1	Read On-request Data
Other codings								Reserved

Table 12: Control Parameter

Bit 7	Bit 6	Bit 5	Bit 4	Bit3	Bit2	Bit 1	Bit 0	Definition of Status octets
0	0	0	0	0	0	0	0	Done / Transfer terminated
0	0	0	0	0	0	0	1	IDLE Sequence
1	0	0	0	0	0	0	0	IOL_Error PDU
Other codings								Reserved

Table 13: Status Parameter

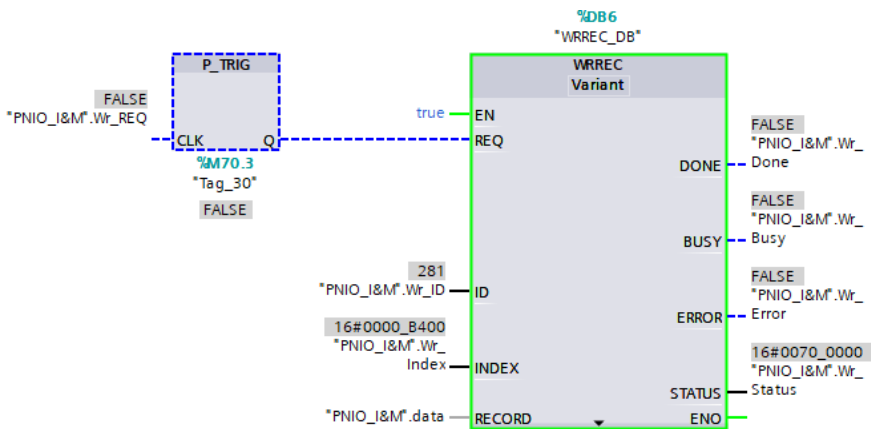

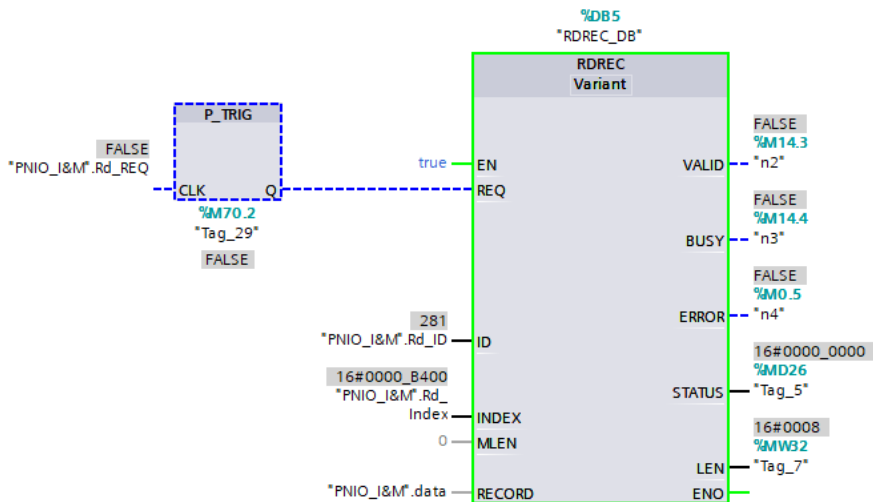

Static				
Rd_REQ	Bool	false	FALSE	
Rd_Index	DWord	16#0	16#0000_B400	
Rd_ID	HW_IO	0	281	
Rd_Valid	Bool	false	FALSE	
Rd_Busy	Bool	false	FALSE	
Rd_Error	Bool	false	FALSE	
Rd_Status	DWord	16#0	16#0000_0000	
Rd_Len	UInt	0	0	
Wr_REQ	Bool	false	FALSE	
Wr_Index	DWord	16#0	16#0000_B400	
Wr_ID	HW_IO	0	281	
Wr_Done	Bool	false	FALSE	
Wr_Busy	Bool	false	FALSE	
Wr_Error	Bool	false	FALSE	
Wr_Status	DWord	16#0	16#0000_0000	
Wr_Len	UInt	0	0	
data	Array[0..39] of Byte			
data[0]	Byte	16#0	16#08	
data[1]	Byte	16#0	16#05	
data[2]	Byte	16#0	16#FE	
data[3]	Byte	16#0	16#4A	
data[4]	Byte	16#0	16#03	
data[5]	Byte	16#0	16#00	
data[6]	Byte	16#0	16#18	
data[7]	Byte	16#0	16#00	
data[8]	Byte	16#0	16#00	
data[9]	Byte	16#0	16#00	
data[10]	Byte	16#0	16#00	
data[11]	Byte	16#0	16#00	
data[12]	Byte	16#0	16#00	
data[13]	Byte	16#0	16#00	
data[14]	Byte	16#0	16#00	
data[15]	Byte	16#0	16#00	
data[16]	Byte	16#0	16#00	
data[17]	Byte	16#0	16#00	

Figure 40: Example of data before reading



























	Wr_REQ	Bool	false	TRUE
	Wr_Index	DWord	16#0	16#0000_B400
	Wr_ID	HW_IO	0	281
	Wr_Done	Bool	false	FALSE
	Wr_Busy	Bool	false	FALSE
	Wr_Error	Bool	false	FALSE
	Wr_Status	DWord	16#0	16#0000_0000
	Wr_Len	UInt	0	0
	▼ data	Array[0..39] of Byte		
	data[0]	Byte	16#0	16#08
	data[1]	Byte	16#0	16#05
	data[2]	Byte	16#0	16#FE
	data[3]	Byte	16#0	16#4A
	data[4]	Byte	16#0	16#03
	data[5]	Byte	16#0	16#00
	data[6]	Byte	16#0	16#18
	data[7]	Byte	16#0	16#00
	data[8]	Byte	16#0	16#00
	data[9]	Byte	16#0	16#00
	data[10]	Byte	16#0	16#00
	data[11]	Byte	16#0	16#00
	data[12]	Byte	16#0	16#00
	data[13]	Byte	16#0	16#00
	data[14]	Byte	16#0	16#00
	data[15]	Byte	16#0	16#00
	data[16]	Byte	16#0	16#00
	data[17]	Byte	16#0	16#00

Figure 41: Example of data after reading

Name	Data type	Start value	Monitor value
▼ Static			
■ Rd_REQ	Bool	false	TRUE
■ Rd_Index	DWord	16#0	16#0000_B400
■ Rd_ID	HW_IO	0	281
■ Rd_Valid	Bool	false	FALSE
■ Rd_Busy	Bool	false	FALSE
■ Rd_Error	Bool	false	FALSE
■ Rd_Status	DWord	16#0	16#0000_0000
■ Rd_Len	UInt	0	0
▼ data	Array[0..39] of Byte		
■ data[0]	Byte	16#0	16#08
■ data[1]	Byte	16#0	16#05
■ data[2]	Byte	16#0	16#FE
■ data[3]	Byte	16#0	16#4A
■ data[4]	Byte	16#0	16#00
■ data[5]	Byte	16#0	16#00
■ data[6]	Byte	16#0	16#18
■ data[7]	Byte	16#0	16#00
■ data[8]	Byte	16#0	16#54
■ data[9]	Byte	16#0	16#45
■ data[10]	Byte	16#0	16#53
■ data[11]	Byte	16#0	16#54
■ data[12]	Byte	16#0	16#00
■ data[13]	Byte	16#0	16#00
■ data[14]	Byte	16#0	16#00
■ data[15]	Byte	16#0	16#00
■ data[16]	Byte	16#0	16#00
■ data[17]	Byte	16#0	16#00

Figure 42: Read data after reading

6.5.2.3 Error PDU for the Read/Write sequence

Offset	Parameter	Content	Data type
0	Port Error	Error Codes detected by the Linking Module or Client	Unsigned16
2	Error Code	IO-Link Error codes according AL_Read/ AL_Write services	Unsigned8
3	Additional Code	IO-Link Error codes according AL_Read/ AL_Write services	Unsigned8

Table 14: Error PDU

Port Error Code	Definition	Coding	Originator
No error	No error detected	0x0000	Server
Reserved	–	0x0001 to 0x06FFF	–
IOL_CALL conflict	Inconsistent Header information	0x7000	Server and/or Client
Incorrect IOL_CALL	Inconsistent Header information (send-/response)	0x7001	Server and/or Client
Port blocked	Port temporary not available	0x7002	Server
Reserved	–	0x7003 to 0x7FFF	–
Timeout	No correct termination of IOL_CALL (Resource Busy detection)	0x8000	Client
Invalid port number	Invalid port Number or port not supported	0x8001	Client and/or Server
Invalid IOL_Index	Invalid Index	0x8002	Client
Invalid IOL_Subindex	Invalid Subindex	0x8003	Client
No Device	No device	0x8004	Client
Reserved	–	0x8005 to 0x8051	–
RDREC Fault	Fault during Read record invocation	0x8052	Client
WRREC Fault	Fault during Write record invocation	0x8053	Client
Unexpected Error	Unspecific Error detected	0x8054	Client
Port Function error	Port function failed	0x8055	Server

Port Error Code	Definition	Coding	Originator
Port Function not available	Port function is not available (in this state)	0x8056	Server
Port Function not supported	Port function (for this port) not supported	0x8057	Server
Manu	Manufacturer specific	0x8058 to 0xFFFF	Server

Table 15: Port Error of Error PDU

6.6 SNMP

The PROFINET IO-Link Master supports SNMP objects required by the PROFINET specification as per protocol standard SNMP v1. These include objects from RFC 1213 MIB-II (System Group and Interfaces Group) and the LLDP MIB.

Passwords:

- ▶ Read Community: public
- ▶ Write Community: private

6.7 Media Redundancy Protocol (MRP)

Redundant PROFINET communication can be implemented with the LioN-P modules via a ring topology without the use of additional switches. A MRP redundancy manager terminates the ring, detects individual failures, and transmits the data packets on the redundant path in case of error.

The following conditions must be met to use MRP:

- ▶ All devices must support MRP.
- ▶ MRP must be enabled on all devices.
- ▶ Connections to the devices are only possible via the ring ports. A mesh topology is not permissible.
- ▶ A max. of 50 devices are permissible in the ring.
- ▶ All devices share the same redundancy domain.
- ▶ One device must be configured as the redundancy manager.
- ▶ All other devices must be configured as redundancy clients.
- ▶ Prioritized boot (FSU) is permissible.
- ▶ The response monitoring time of all devices must be greater than the reconfiguration time (typically 200 ms, min. 90 ms for LioN-P modules).
- ▶ It is recommended to use automatic network settings on all devices.

The following figures show a possible MRP ring configuration. The PLC is used as the redundancy manager while all other devices are clients. To detect an individual failure, it is advisable to use the diagnostics alerts.

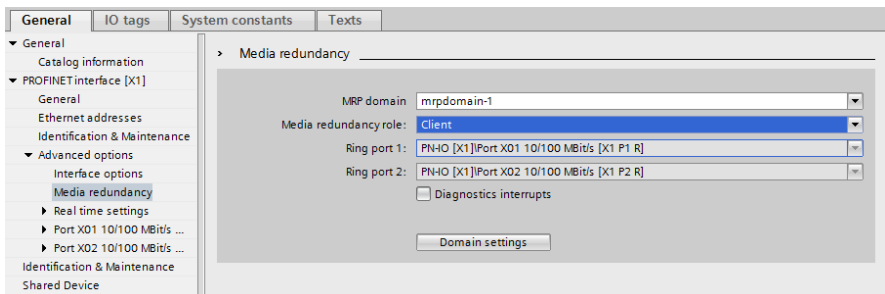

Figure 43: Example of setting up an MRP redundancy client in TIA Portal®

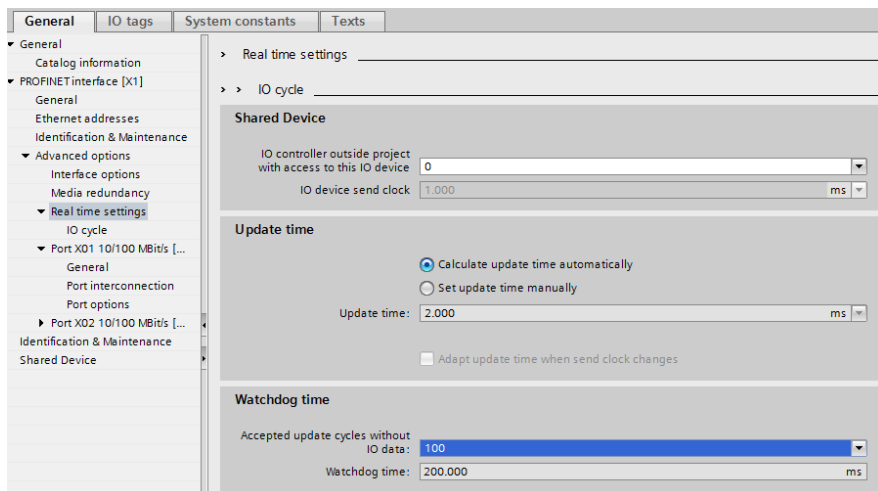

Figure 44: Example of setting up the Watchdog time monitoring in TIA Portal® for using MRP

6.8 Identification & maintenance functions (I&M)

The PROFINET module has the ability to uniquely identify the devices installed in the system via an electronic nameplate. This device-specific data can be read acyclically by the user at any time. Furthermore, the installation date, location code and further descriptions can be stored in the module when creating the system. The I&M functions provide this functionality.

6.8.1 Supported I&M features

6.8.1.1 I&M data of the PN-IO Device

For reading (I&M 0 - 3) and writing (I&M 1 - 3) I&M data, the appropriate Hardware identifier for Slot **0: PROFINET Interface** (Slot 0 / Sub-slot 1) must be chosen:

Device overview							
Module	...	Rack	Slot	I address	Q address	Type	Article number
▼ 0980-ESL-399-121-S2		0	0: PR...			0980 ESL 399-121...	935 021 004
▶ PN-IO		0	0: PR...			0980-ESL-399-121...	
▼ IO-Link Master_1		0	1: IO ...			IO-Link Master	
Status/Control Module		0	1: IO ...	1...2	1...2	Status/Control Mod...	
Digital In (A) / Digital (B)		0	1: IO ...	68		Digital In (A) / Digit...	
Digital Out (A) / Digital (B)		0	1: IO ...		64	Digital Out (A) / Dig...	
Digital In (A) / Digital (B)_1		0	1: IO ...	74		Digital In (A) / Digit...	
IO-Link I/O 4/4 Bytes, PQI		0	1: IO ...	69...73	65...68	IO-Link I/O 4/4 Byte...	
Digital In (A) / Digital (B)_2		0	1: IO ...	75		Digital In (A) / Digit...	
IO-Link I/O 4/4 Bytes, PQI...		0	1: IO ...	76...80	69...72	IO-Link I/O 4/4 Byte...	
Inactive (A/B)_6		0	1: IO ...	9		Inactive (A/B)	
Inactive (A/B)_7		0	1: IO ...	10		Inactive (A/B)	

Figure 45: Device overview

Name	Type	Hardware identifier	Used by	Comment
0980-ESL-399-121-S2-PNIO-Port_X01_10_100_MBit_s	Hw_Interface	277	PLC_1	
0980-ESL-399-121-S2-PNIO-Port_X02_10_100_MBit_s	Hw_Interface	278	PLC_1	
0980-ESL-399-121-S2-PNIO	Hw_Interface	276	PLC_1	
0980-ESL-399-121-S2-Proxy	Hw_SubModule	275	PLC_1	
0980-ESL-399-121-S2-Head	Hw_SubModule	279	PLC_1	
0980-ESL-399-121-S2-IO-Link_Master_1	Hw_SubModule	280	PLC_1	
0980-ESL-399-121-S2-IO-Link_Master_1-5status_Control_Module	Hw_SubModule	281	PLC_1	
Inective_(A,B)_6-DI	Hw_SubModule	271	PLC_1	
Inective_(A,B)_7-DI	Hw_SubModule	272	PLC_1	
0980-ESL-399-121-S2-IO-Link_Master_1-Digital_In_(A)___Digital_(B)	Hw_SubModule	270	PLC_1	
0980-ESL-399-121-S2-IO-Link_Master_1-Digital_Out_(A)___Digital_(B)	Hw_SubModule	282	PLC_1	
0980-ESL-399-121-S2-IO-Link_Master_1-IO-Link_I_O_4_4_Bytes_PQI	Hw_SubModule	283	PLC_1	
0980-ESL-399-121-S2-IO-Link_Master_1-Digital_In_(A)___Digital_(B)_1	Hw_SubModule	284	PLC_1	
0980-ESL-399-121-S2-IO-Link_Master_1-Digital_In_(A)___Digital_(B)_2	Hw_SubModule	285	PLC_1	
0980-ESL-399-121-S2-IO-Link_Master_1-IO-Link_I_O_4_4_Bytes_PQI_1	Hw_SubModule	286	PLC_1	

Figure 46: TIA Portal® Hardware Identifier of PROFINET Interface® RDREC/WRREC

The device-specific I&M features 0 through 3 can be read or written via slot 0. The specified index is used for mapping the data sets.

Data object	Length [byte]	Access	Default value / Description
MANUFACTURER_ID	2	Read	0x016A (Belden Deutschland GmbH)
ORDER_ID	20	Read	Order number of module in ASCII
SERIAL_NUMBER	16	Read	Defined in production process in ASCII
HARDWARE_REVISION	2	Read	Hardware revision of device
SOFTWARE_REVISION	4	Read	Software revision of device
REVISION_COUNTER	2	Read	Incremented for every statically stored parameter change on IO-Link Master (e.g., device name or IP address)
PROFILE_ID	2	Read	0xF600 (Generic device)
PROFILE_SPECIFIC_TYPE	2	Read	0x0003 (IO modules)
IM_VERSION	2	Read	0x0101 (I&M Version 1.1)
IM_SUPPORTED	2	Read	0x000E (I&M 1 ... 3 is supported)

Table 16: I&M 0 (Slot 0 / Sub-slot 1, Index 0xAFF0)

Data object	Length [byte]	Access	Default value / Description
TAG_FUNCTION	32	Read/ Write	0x20 ff. (empty)
TAG_LOCATION	22	Read/ Write	0x20 ff. (empty)

Table 17: I&M 1 (Slot 0 / Sub-slot 1, Index 0xAFF1)

Data object	Length [byte]	Access	Default value / Description
INSTALLATION_DATE	16	Read/ Write	0x20 ff. (empty); Supported data format is a visible string with a fix length of 16 byte; "YYYY-MM-DD hh:mm" or "YYYY-MM-DD" filled with blank spaces

Table 18: I&M 2 (Slot 0 / Sub-slot 1, Index 0xAFF2)

Data object	Length [byte]	Access	Default value / Description
DESCRIPTOR	54	Read/ Write	0x20 ff. (empty)

Table 19: I&M 3 (Slot 0 / Sub-slot 1, Index 0xAFF3)

6.8.1.2 I&M data of the IOL-Master proxy (Status/Control Module)

For reading *I&M 0* data, the appropriate Hardware identifier for Slot 1: IO System 1 (Slot 1 / Sub-slot 1) must be chosen:

Device overview

Module	Rack	Slot	I address	Q address	Type	Article number
0980-ESL-399-121-S2	0	0: PR...			0980 ESL 399-121-S2	935 021 004
PNHO	0	0: PR...			0980-ESL-399-121-S2	
IO-Link Master_1	0	1: IO ...			IO-Link Master	
Status/Control Module	0	1: IO ...	1...2	1...2	Status/Control Module	
Digital In (A) / Digital (B)	0	1: IO ...	68		Digital In (A) / Digital (B)	
Digital Out (A) / Digital (B)	0	1: IO ...		64	Digital Out (A) / Digital (B)	
Digital In (A) / Digital (B)_1	0	1: IO ...	74		Digital In (A) / Digital (B)	
IO-Link I/O 4/4 Bytes, PQI	0	1: IO ...	69...73	65...68	IO-Link I/O 4/4 Bytes, PQI	
Digital In (A) / Digital (B)_2	0	1: IO ...	75		Digital In (A) / Digital (B)	
IO-Link I/O 4/4 Bytes, PQI...	0	1: IO ...	76...80	69...72	IO-Link I/O 4/4 Bytes, PQI	
Inactive (A/B)_6	0	1: IO ...	9		Inactive (A/B)	
Inactive (A/B)_7	0	1: IO ...	10		Inactive (A/B)	

IO-Link Master_1 [IO-Link Master]

Name	Type	Hardware identifier	Used by	Comment
0980-ESL-399-121-S2-IO-Link_Master_1	Hw_SubModule	280	PLC_1	
0980-ESL-399-121-S2-IO-Link_Master_1-Status_Control_Module	Hw_SubModule	281	PLC_1	
Inactive_(A,B)_6-DI	Hw_SubModule	271	PLC_1	
Inactive_(A,B)_7-DI	Hw_SubModule	272	PLC_1	
0980-ESL-399-121-S2-IO-Link_Master_1-Digital_In_(A)___Digital_(B)	Hw_SubModule	270	PLC_1	
0980-ESL-399-121-S2-IO-Link_Master_1-Digital_Out_(A)___Digital_(B)	Hw_SubModule	282	PLC_1	
0980-ESL-399-121-S2-IO-Link_Master_1-IO-Link_I_O_4_4_Bytes___PQI	Hw_SubModule	283	PLC_1	
0980-ESL-399-121-S2-IO-Link_Master_1-Digital_In_(A)___Digital_(B)_1	Hw_SubModule	284	PLC_1	
0980-ESL-399-121-S2-IO-Link_Master_1-Digital_In_(A)___Digital_(B)_2	Hw_SubModule	285	PLC_1	
0980-ESL-399-121-S2-IO-Link_Master_1-IO-Link_I_O_4_4_Bytes___PQI_1	Hw_SubModule	286	PLC_1	

Figure 47: Hardware identifier of the Status/Control Module for RDREC

Data object	Length [byte]	Access	Default value / Description
MANUFACTURER_ID	2	Read	0x016A (Belden Deutschland GmbH)
ORDER_ID	20	Read	Order number of module in ASCII
SERIAL_NUMBER	16	Read	Defined in production process in ASCII
HARDWARE_REVISION	2	Read	Hardware revision of device
SOFTWARE_REVISION	4	Read	Software revision of device
REVISION_COUNTER	2	Read	Incremented for every statically stored parameter change on IO-Link Master (e.g., device name or IP address)
PROFILE_ID	2	Read	0x4E01 (IOL-Master proxy)
PROFILE_SPECIFIC_TYPE	2	Read	0x0000 (unspecified)
IM_VERSION	2	Read	0x0101 (I&M Version 1.1)
IM_SUPPORTED	2	Read	0x0000

Table 20: I&M 0 (Slot 1 / Sub-slot 1, Index 0xAFF0)

6.8.1.3 I&M data of the IOL-Device proxy

The IO-Link Device-specific I&M functions can be read via slot 1 and the appropriate sub-slot (**1.2/Port X1 ...1.9/Port X8**). The specified index is used for mapping the data sets. Only data not equal to zero are received if a connection to an IO-Link Device can be established.

Device overview							
Module	Rack	Slot	I address	Q address	Type	Article number	
0980-ESL-399-121-52	0	0: PR...			0980 ESL 399-121-52	935 021 004	
PN40	0	0: PR...			0980-ESL-399-121-52		
IO-Link Master_1	0	1: IO ...			IO-Link Master		
Status/Control Module	0	1: IO ...	1...2	1...2	Status/Control Module		
Digital In (A) / Digital (B)	0	1: IO ...	68		Digital In (A) / Digital (B)		
Digital Out (A) / Digital (B)	0	1: IO ...		64	Digital Out (A) / Digital (B)		
Digital In (A) / Digital (B)_1	0	1: IO ...	74		Digital In (A) / Digital (B)		
IO-Link I/O 4/4 Bytes, PQI	0	1: IO ...	69...73	65...68	IO-Link I/O 4/4 Bytes, PQI		
Digital In (A) / Digital (B)_2	0	1: IO ...	75		Digital In (A) / Digital (B)		
IO-Link I/O 4/4 Bytes, PQI...	0	1: IO ...	76...80	69...72	IO-Link I/O 4/4 Bytes, PQI		
Inactive (A/B)_6	0	1: IO ...	9		Inactive (A/B)		
Inactive (A/B)_7	0	1: IO ...	10		Inactive (A/B)		

IO-Link I/O 4/4 Bytes, PQI_1 [IO-Link I/O 4/4 Bytes, PQI]					Properties	Info
General	IO tags	System constants	Texts			
Show hardware system constant						
Name	Type	Hardware identifier	Used by	Comment		
0980-ESL-399-121-52-IO-Link_Master_1-IO-Link_I_O_4_4_Bytes_PQI_1	Hw_SubModule	286	PLC_1			

Figure 48: Hardware identifier of the Status/Control Module for RDREC

I&M0 data	Octets	Data type	Mapping rules
VendorID	2	Unsigned16	IO-Link Direct parameter page 1: VendorID. Direct mapping, for example "0x136". Exceptions: 1 → 93; 26 → 257; 87 → 467.
OrderID	20	Visible String	"Product Name" or "DeviceID".
IM_Serial_Number	16	Visible String	Insert SerialNumber of Device (IO-Link Index 21). If it is not available set to "Not accessible".
IM_Hardware_Revision	2	Unsigned8	Set to 0x0000 (Default value)
IM_Software_Revision	4	Char,3 x Unsigned8	Set to V0.0.0 (official release but not detectable)
IM_RevisionCounter	2	Unsigned16	Set to "0" (0x0000)
IM_Profile_ID	2	Unsigned16	IO-Link (API = 0x4E01)
IM_Profile_Specific_Type	2	Unsigned16	Set to "0" (0x0000)
IM_Version	2	2 x Unsigned8	Octet 1 (MSB): set to 0x01 Octet 2 (LSB): set to 0x00
IM_Supported	2	Unsigned16 (Bit Array)	Profile specific I&M: 0x0000 (Bit 0 for I&M0 is always 0)

Table 21: I&M 0 (Slot 1: Sub-slot 2..9, Index 0xAFF0)

I&M5 data	Octets	Data type	Mapping rules
IM_UniquelIdentifier	16	UUID	Reference according PROFINET specification [3]
AM_Location	64	64 octets	Fill with 0x00
IM_Annotation	64	String (UTF8)	"IO-Link" Devices"
IM_OrderID	20	Visible String	"Product Name" or "DeviceID".
AM_SoftwareRevision	64	String (UTF8)	Insert SoftwareRevision of Device (IO-Link Index). If it is not available set to "Not accessible".
AM_HardwareRevision	64	String (UTF8)	Insert HardwareRevision of Device (IO-Link Index). If it is not available set to "Not accessible".
IM_Serial_Number	16	Visible String	Insert SerialNumber of Device (IO-Link Index 21). If it is not available set to "Not accessible".

I&M5 data	Octets	Data type	Mapping rules
IM_Software_Revision	4	Char,3 x Unsigned8	Set to V0.0.0 (official release but not detectable)
AM_DeviceIdentification	8	Unsigned16 Unsigned16 Unsigned16 Unsigned16	DeviceSubID : 0x0000 DeviceID VendorID Organization: 0x0001 (IO-Link)
AM_TypeIdentification	2	Unsigned16	0x4E01 (API of IO-Link)
IM_Hardware_Revision	2	Unsigned8	Set to 0x0000 (default value)

Table 22: I&M 5 (Slot 1: Sub-slot 2..9, Index 0xAFF5)

6.8.2 Reading and writing I&M data

In its standard library, SIEMENS offers TIA Portal® system function modules that allow I&M data to be read and written. A data set contains a 6-byte *BlockHeader* and the I&M record.

The data requested on reading, or the data to be written thus only start after the existing header. On writing, the header content must additionally be taken into account. [Table 23: Data set with BlockHeader and I&M Record](#) on page 93 shows the structure of a data set.

For reading I&M data, the RDREC block must be configured with `LEN = 6Byte Block Header + I&M data length`.

Data object	Length [byte]	Data type	Coding	Description
BlockType	2	Word	I&M 0: 0x0020 I&M 1: 0x0021 I&M 2: 0x0022 I&M 3: 0x0023 I&M 5: 0x0025	BlockHeader
BlockLength	2	Word	I&M 0: 0x0038 I&M 1: 0x0038 I&M 2: 0x0012 I&M 3: 0x0038 I&M 5: 014C	
BlockVersionHigh	1	Byte	0x01	
BlockVersionLow	1	Byte	0x00	
I&M Data	I&M 0: 54 I&M 1: 54 I&M 2: 16 I&M 3: 54 I&M 5: 330	Byte		I&M Record

Table 23: Data set with BlockHeader and I&M Record

6.8.2.1 I&M Read Record

I&M data can be read via the standard RDREC (SFB52) function block in the **Siemens PLC**. The logical address of the slot/sub-slot (ID) and the I&M index (INDEX) must be used as handover parameters. The return parameters show the length of the I&M data received, and contain a status or error message.

PNIO_I&M				
	Name	Data type	Start value	Monitor value
1	Static			
2	FB_Inputs			
3	Rd_REQ	Bool	false	TRUE
4	Rd_Index	DWord	16#0	16#0000_AFF0
5	Rd_ID	HW_IO	0	279
6	FB_Outputs			
7	Rd_Valid	Bool	false	TRUE
8	Rd_Busy	Bool	false	FALSE
9	Rd_Error	Bool	false	FALSE
10	Rd_Status	DWord	16#0	16#0000_0000
11	Rd_Len	UInt	0	0
20	Data_Header			
21	data	Array[0..60] of Byte		
22	data[0]	Byte	16#0	16#00
23	data[1]	Byte	16#0	16#20
24	data[2]	Byte	16#0	16#00
25	data[3]	Byte	16#0	16#38
26	data[4]	Byte	16#0	16#01
27	data[5]	Byte	16#0	16#00
28	Data_record			
29	data[6]	Byte	16#0	16#00
30	data[7]	Byte	16#0	16#5D
31	data[8]	Byte	16#0	16#37
32	data[9]	Byte	16#0	16#30
33	data[10]	Byte	16#0	16#31
34	data[11]	Byte	16#0	16#30
35	data[12]	Byte	16#0	16#33
36	data[13]	Byte	16#0	16#36
37	data[14]	Byte	16#0	16#30

Figure 49: Example of a completed I&M 0 read action

6.8.2.2 I&M Write Record

I&M data can be written via the standard WRREC (SFB53) function block in the **Siemens PLC**. The logical address of the slot/sub-slot (ID), the I&M index (INDEX) and the data length (LEN) must be used as handover parameters. The return parameters contain a status or error message.

PNIO_I&M				
	Name	Data type	Start value	Monitor value
1	Static			
2	FB_Inputs			
3	Wr_REQ	Bool	false	TRUE
4	Wr_Index	DWord	16#0	16#0000_AFF1
5	Wr_ID	HW_IO	0	279
6	FB_Outputs			
7	Wr_Done	Bool	false	TRUE
8	Wr_Busy	Bool	false	FALSE
9	Wr_Error	Bool	false	FALSE
10	Wr_Status	DWord	16#0	16#0000_0000
11	Wr_Len	UInt	0	0
20	Data_Header			
21	data	Array[0..60] of Byte		
22	data[0]	Byte	16#0	16#00
23	data[1]	Byte	16#0	16#21
24	data[2]	Byte	16#0	16#00
25	data[3]	Byte	16#0	16#38
26	data[4]	Byte	16#0	16#01
27	data[5]	Byte	16#0	16#00
28	Data_record			
29	data[6]	Byte	16#0	16#61
30	data[7]	Byte	16#0	16#62
31	data[8]	Byte	16#0	16#63
32	data[9]	Byte	16#0	16#20
33	data[10]	Byte	16#0	16#20
34	data[11]	Byte	16#0	16#20
35	data[12]	Byte	16#0	16#20
36	data[13]	Byte	16#0	16#20
37	data[14]	Byte	16#0	16#20

Figure 50: Example of a completed I&M 1 write action

6.9 Fast Start-Up (FSU) / Prioritized Start-Up

The LioN-P modules with Fast Start-Up (FSU) support an optimized system start-up. This guarantees a faster restart after the power supply is restored.

Fast Start-Up can be activated for the LioN-P modules with **PROFINET interface [X1] > Advanced options > Interface options** over **Prioritized start-up**.

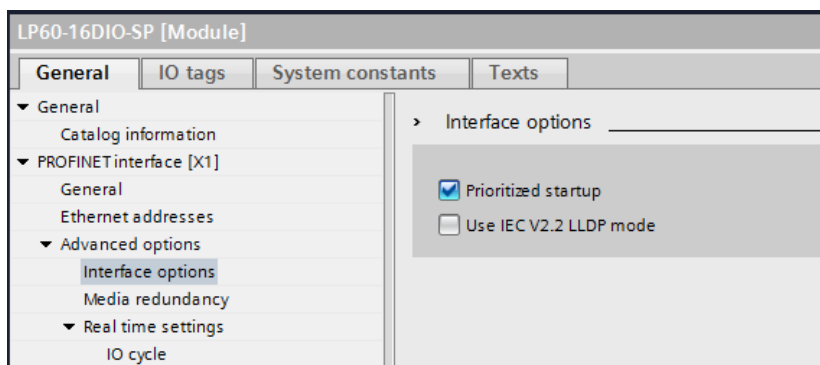

7 Bit assignment

The LioN-P IO-Link Master modules use a modular device model. Slot 1/ sub-slot 1 contains the Status/Control Module of the IO-Link Master. The module has 2 bytes of input data and 2 bytes of output data for IO-Link Master modules with PROFINET System Redundancy S2. It is always statically configured on selecting a LioN-P IO-Link Master from the GSD file.

The IO-Link ports use the following sub-slots 2 through 9 of slot 1; they can have a different operating mode and data length depending on the configuration.

7.1 Process data Status/Control Module, slot 1.1/IO System 1

The Status/Control Module has one UINT16 for digital input data and one UINT16 for digital output data.

Status Data (input)

The input UINT16 contains the status of the digital inputs. For the digital A-channel inputs, the data are also available in the input byte of the appropriate sub-slot module.

Control Data (output)

The output UINT16 contains the control bits for the digital outputs of the B-channels.

For controlling the digital A-Channels, the output **Byte 1/Bit 0** of the appropriate sub-slot module must be used.

Over the **General Device Settings** parameter **Digital Out Ch. A Controlled By: Status/Control Module** the control can be switched to the *Control Bits*. In this case, the outputs cannot be controlled by the sub-slot output **Byte 1/Bit 0**.

The digital output can be controlled only by one data source.

Parameter Dependencies for Digital-IO data mapping

Please refer to chapter [General Device Settings](#) on page 54 for the Bit Mapping Mode (BMM) and Byte Order Mode (BOM) settings for the Digital-IO mapping of Status/Control Module data.

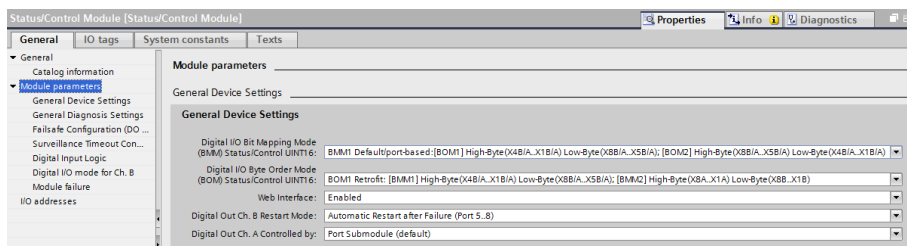

7.1.1 Status/Control data with Bit Mapping Mode 1 (default mapping)

7.1.1.1 Digital Input Status with BMM1 & Byte Order Mode 1

INPUT	Input	Bit 7	Bit 6	Bit 5	Bit 4	Bit 3	Bit 2	Bit 1	Bit 0
Status/ Control Slot 1.1	UINT16 High Byte	DI X4B	DI X4A	DI X3B	DI X3A	DI X2B	DI X2A	DI X1B	DI X1A
	UINT16 Low Byte	DO X8B	DI X8A	DO X7B	DI X7A	DO X6B	DI X6A	DO X5B	DI X5A

Table 24: Digital Input Status BMM1 & BOM1

In **Digital Output** and **Auxiliary Power** mode, the digital output states are mirrored as status in the digital inputs .

Key:

- ▶ The data in the cells highlighted in blue are only available for LioN-P 60 devices in Auxiliary Power and Digital Output Mode.
- ▶ DI 1A = Digital Input Port 1, Channel A (Pin 4)
- ▶ DO 7B = Output Status Port 7 B

7.1.1.2 Digital Input Status with BMM1 & Byte Order Mode 2

INPUT	Input	Bit 7	Bit 6	Bit 5	Bit 4	Bit 3	Bit 2	Bit 1	Bit 0
Status/ Control Slot 1.1	UINT16 High Byte	DO X8B	DI X8A	DO X7B	DI X7A	DO X6B	DI X6A	DO X5B	DI X5A
	UINT16 Low Byte	DI X4B	DI X4A	DI X3B	DI X3A	DI X2B	DI X2A	DI X1B	DI X1A

Table 25: Digital Input Status BMM1 & BOM2

In **Digital Output** and **Auxiliary Power** mode, the digital output states are mirrored as status in the digital inputs .

Key:

- ▶ The data in the cells highlighted in blue are only available for LioN-P 60 devices in Auxiliary Power and Digital Output Mode.
- ▶ DI 1A = Digital Input Port 1, Channel A (Pin 4)
- ▶ DO 7B = Output Status Port 7 B

7.1.1.3 Digital Output Control with BMM1 & Byte Order Mode 1

OUTPUT	Output	Bit 7	Bit 6	Bit 5	Bit 4	Bit 3	Bit 2	Bit 1	Bit 0
Status/ Control Slot 1.1	UINT16 High Byte	n.a.	opt. DO X4A	n.a.	opt. DO X3A	n.a.	opt. DO X2A	n.a.	opt. DO X1A
	UINT16 Low Byte	DO X8B	opt. DO X8A	DO X7B	opt. DO X7A	DO X6B	opt. DO X6A	DO X5B	opt. DO X5A

Table 26: Digital Output Control BMM1 & BOM1

Key:

- ▶ The data in the cells highlighted in blue are only available for LioN-P 60 devices.
- ▶ n.a. = not available
- ▶ DO 5B = Digital Output Port 1, Channel B (Pin 2)
- ▶ opt. DO 1A = Optional, when configured as DO and the **General device** parameter **Digital Out Ch. A Controlled by** is set to *Status/Control Module*. (Otherwise, the control data are represented in bit 0 of the corresponding sub-slot byte.)

7.1.1.4 Digital Output Control with BMM1 & Byte Order Mode 2

OUTPUT	Output	Bit 7	Bit 6	Bit 5	Bit 4	Bit 3	Bit 2	Bit 1	Bit 0
Status/ Control Slot 1.1	UINT16 High Byte	DO X8B	opt. DO X8A	DO X7B	opt. DO X7A	DO X6B	opt. DO X6A	DO X5B	opt. DO X5A
	UINT16 Low Byte	n.a.	opt. DO X4A	n.a.	opt. DO X3A	n.a.	opt. DO X2A	n.a.	opt. DO X1A

*Table 27: Digital Output Control BMM1 & BOM2***Key:**

- ▶ The data in the cells highlighted in blue are only available for LioN-P 60 devices.
- ▶ n.a. = not available
- ▶ DO 5B = Digital Output Port 1, Channel B (Pin 2)
- ▶ opt. DO 1A = Optional, when configured as DO and the **General device** parameter **Digital Out Ch. A Controlled by** is set to *Status/Control Module*. (Otherwise, the control data are represented in bit 0 of the corresponding sub-slot byte.)

7.1.2 Status/Control data with Bit Mapping Mode 2 (Retrofit)

7.1.2.1 Digital Input Status with BMM2 & Byte Order Mode 1

INPUT	Input	Bit 7	Bit 6	Bit 5	Bit 4	Bit 3	Bit 2	Bit 1	Bit 0
Status/ Control Slot 1.1	UINT16 High Byte	DI X8A	DI X7A	DI X6A	DI X5A	DI X4A	DI X3A	DI X2A	DI X1A
	UINT16 Low Byte	DO X8B	DO X7B	DO X6B	DO X5B	DI X4B	DI X3B	DI X2B	DI X1B

Table 28: Digital Input Status BMM2 & BOM1

Key:

- ▶ The digital input data return the status of the digital inputs.
- ▶ The data in the cells highlighted in blue are only available for LioN-P 60 devices and are representing the output status.
- ▶ DI 1A = Digital Input Port 1, Channel A (Pin 4)
- ▶ DO 7B = Output Status Port 7 B

7.1.2.2 Digital Input Status with BMM2 & Byte Order Mode 2

INPUT	Input	Bit 7	Bit 6	Bit 5	Bit 4	Bit 3	Bit 2	Bit 1	Bit 0
Status/ Control Slot 1.1	UINT16 High Byte	DO X8B	DO X7B	DO X6B	DO X5B	DI X4B	DI X3B	DI X2B	DI X1B
	UINT16 Low Byte	DI X8A	DI X7A	DI X6A	DI X5A	DI X4A	DI X3A	DI X2A	DI X1A

Table 29: Digital Input Status BMM2 & BOM2

Key:

- ▶ The digital input data return the status of the digital inputs.
- ▶ The data in the cells highlighted in blue are only available for LioN-P 60 devices and are representing the output status.
- ▶ DI 1A = Digital Input Port 1, Channel A (Pin 4)
- ▶ DO 7B = Output Status Port 7 B

7.1.2.3 Digital Output Control for BMM2 & Byte Order Mode 1

OUTPUT	Output	Bit 7	Bit 6	Bit 5	Bit 4	Bit 3	Bit 2	Bit 1	Bit 0
Status/ Control Slot 1.1	UINT16 High Byte	opt. DO X8A	opt. DO X7A	opt. DO X6A	opt. DO X5A	opt. DO X4A	opt. DO X3A	opt. DO X2A	opt. DO X1A
	UINT16 Low Byte	DO X8B	DO X7B	DO X6B	DO X5B	n.a.	n.a.	n.a.	n.a.

*Table 30: Digital Output Control BMM2 & BOM1***Key:**

- ▶ The data in the cells highlighted in blue are only available for LioN-P 60 devices.
- ▶ DO 5B = Digital Output Port 1, Channel B (Pin 2)
- ▶ opt. DO 1A = optional when configured as DO and the **General device** parameter **Digital Out Ch. A Controlled by** is set to Status/Control Module

Mapping of the IO-Channel to the PROFINET Channel Diagnostics:

Port	X8	X7	X6	X5	X4	X3	X2	X1
IO Pin	2/4	2/4	2/4	2/4	2/4	2/4	2/4	2/4
IO Channel	B/A	B/A	B/A	B/A	B/A	B/A	B/A	B/A
PN Diagn. Channel	8	7	6	5	4	3	2	1

Table 31: Channel Diagnostics Mapping

7.1.2.4 Digital Output Control for BMM2 & Byte Order Mode 2

OUTPUT	Output	Bit 7	Bit 6	Bit 5	Bit 4	Bit 3	Bit 2	Bit 1	Bit 0
Status/ Control Slot 1.1	UINT16 High Byte	DO X8B	DO X7B	DO X6B	DO X5B	n.a.	n.a.	n.a.	n.a.
	UINT16 Low Byte	opt. DO X8A	opt. DO X7A	opt. DO X6A	opt. DO X5A	opt. DO X4A	opt. DO X3A	opt. DO X2A	opt. DO X1A

Table 32: Digital Output Control BMM2 & BOM2

Key:

- ▶ The data in the cells highlighted in blue are only available for LioN-P 60 devices.
- ▶ DO 5B = Digital Output Port 1, Channel B (Pin 2)
- ▶ opt. DO 1A = optional when configured as DO and the **General device** parameter **Digital Out Ch. A Controlled by** is set to *Status/Control Module*

Mapping of the IO-Channel to the PROFINET Channel Diagnostics:

Port	X8	X7	X6	X5	X4	X3	X2	X1
IO Pin	2/4	2/4	2/4	2/4	2/4	2/4	2/4	2/4
IO Channel	B/A	B/A	B/A	B/A	B/A	B/A	B/A	B/A
PN Diagn. Channel	8	7	6	5	4	3	2	1

Table 33: Channel Diagnostics Mapping

7.2 Process data IO-Link ports, Slot 1.2 – 1.9

The process data lengths of the IO-Link ports in COM mode depend on the IO-Link port configurations X1 – X8. Data lengths between 1 – 33 bytes of input data and/or 1 – 32 bytes of output data are configurable.

The data content can be taken from the descriptions of the IO-Link Device modules. If a precise data length is not available for the IO-Link device configuration, always select the next larger data length.

The last byte of the port input data contains the PQI byte (Port Qualifier Information). This byte is added to the IOL-Device input data by the IOL-Master.

Ch. A configuration as Digital Input

If the Port is configured as digital input, the port data length is one byte and the digital input status will be set on bit 0.

The mapping mode selected for the Status/Control Module has no influence on the process data of the IO-Link ports.

INPUT	Input	Bit 7	Bit 6	Bit 5	Bit 4	Bit 3	Bit 2	Bit 1	Bit 0
Slot 1.2	X1 Byte 1 – 33	▶ If the IO-Link Port is in “Digital-In” Mode, the “DI-C/Q” state (Channel A, Pin 4) will be set in Bit 0 of Byte 1. In this case no PQI Byte is available. ▶ The last Byte contains the PQI (Port Qualifier Information).							
Slot 1.3	X2 Byte 1 – 33								
Slot 1.4	X3 Byte 1 – 33								
Slot 1.5	X4 Byte 1 – 33								
Slot 1.6	X5 Byte 1 – 33								
Slot 1.7	X6 Byte 1 – 33								
Slot 1.8	X7 Byte 1 – 33								
Slot 1.9	X8 Byte 1 – 33								

Table 34: Input data: Sub-slots 1.2 – 1.9

Bit	Acronym	Short Description	Value	Description
0	–	Reserved	0	Reserved
			–	–
1	–	Reserved	0	Reserved
			–	–
2	NewParam	New parameter	0	no update of IOL-Device parameter detected
			1	update of IOL-Device parameter detected: master performed a parameter storage upload (Master to Device) and a new IO-Link Device Backup object (0xB904) is available
3	SubstDev	Substitute Device detection	0	<i>Not supported, don't evaluate this bit!</i>
			1	<i>Not supported, don't evaluate this bit!</i>
4	PortActive	Port activation	0	port deactivated via port function
			1	port activated (default)
5	DevCom	Device communication	0	no IOL-Device available
			1	IOL-Device detected and is in PREOPERATE or OPERATE state
6	DevErr	Port/Device error indication	0	no error/warning occurred
			1	error/warning assigned to IOL-Device or IOL-Master port occurred
7	PQ	Device Process Data validity	0	invalid IO process data from IOL-Device
			1	valid IO process data from device

Table 35: PQI description

OUTPUT	Output	Bit 7	Bit 6	Bit 5	Bit 4	Bit 3	Bit 2	Bit 1	Bit 0
Slot 1.2	X1 Byte 1 – 32	▶ optional / If IO-Link Port is in "Digital-Out" Mode, the "DO-C/Q" state (Channel A, Pin 4) will be set in Bit 0 of Byte 1.							
Slot 1.3	X2 Byte 1 – 32								
Slot 1.4	X3 Byte 1 – 32								
Slot 1.5	X4 Byte 1 – 32								
Slot 1.6	X5 Byte 1 – 32								
Slot 1.7	X6 Byte 1 – 32								
Slot 1.8	X7 Byte 1 – 32								
Slot 1.9	X8 Byte 1 – 32								

Table 36: Output data: Sub-slots 1.2 – 1.9

Ch. A configuration as Digital Output

If the Port is configured as digital output, the port data length is one byte (one byte with digital output control in bit 0).

If the **General device** parameter **Digital Out Ch. A Controlled by** is set to **Status/Control Module**, the output cannot be controlled by bit 0 in the port output byte.

8 Diagnostics processing

8.1 Error of the system/sensor power supply

The voltage value for the incoming system/sensor power supply is also monitored globally. If the voltage drops below approx. 18 V, or exceeds approx. 30 V, an error message is generated.

The green U_S indicator is off.

The error message has no effect on the outputs.



Caution: It must definitely be ensured that the supply voltage, measured at the most remote participant is not below 18 V DC from the perspective of the system power supply.

The following group diagnostic message is generated:

Channel number of diagnosis	0x8000 (diagnosis not channel-specific)
Channel related diagnosis code	0x0002
Channel related diagnosis code message	Undervoltage

8.2 Error of the auxiliary/actuator power supply

The voltage value for the incoming auxiliary/actuator power supply is also monitored globally. If U_{Aux} diagnostic messaging is enabled, an error message is generated if the voltage drops below approx. 18 V or exceeds approx. 30 V.

The U_{Aux} indicator shows red. If output channels are enabled, additional error messages caused by the voltage failure are generated on the IO ports. U_{Aux} diagnostic messaging is disabled by default and must be enabled via parameterization.

The following group diagnostic message is generated:

Channel number of diagnosis	0x8000 (diagnosis not channel-specific)
Channel related diagnosis code	0x0103
Channel related diagnosis code message	Voltage fault of auxiliary power supply (U_{Aux}), detected by IO-Link master

8.3 Overload/short-circuit of the IO port sensor supply outputs

In case of an overload or a short circuit between pin 1 and pin 3 on the ports (X1 - X8), the following channel-specific diagnostic messages are generated:

Channel number of diagnosis	0x01 - 0x08
Channel related diagnosis code	0x1806
Channel related diagnosis code message	Master/Port diagnosis - Short circuit at L+
Extended description	Short circuit on sensor power supply at pin 1 (L+) of I/O port. Check wire connection.

8.4 Overload/short circuit of the digital 500 mA outputs

The digital outputs on the C/Q pin (except 0980 ESL 3x8-121) are short circuit and overload protected. In case of a fault, the output is automatically switched off and cyclically automatically switched back on.

The device sends the following PROFINET diagnostic message in case of a fault:

Channel number of diagnostics	0x01 - 0x08
Channel related diagnostic code	0x1811
Channel related diagnostic code message	Master/Port diagnosis - Short circuit at C/Q

8.5 Overload/short circuit of the digital outputs

There are four 2 A outputs available for variants 0980 ESL 3x9-121 or 1.6 A outputs available for variants 0980 ESL 3x8-121 on the Class B ports of the LioN-P 60 devices.

A channel error is determined by comparing the target value set by a controller and the actual value of an output channel.

Target value	Actual value	Comment
Active	Active	OK, no diagnostics
Off	Off	OK, no diagnostics
Active	Off	Short-circuit Channel indicator is red. Channel error bit in the diagnostics is set. Channel is locked after the error is rectified. ¹

Table 37: Interpretation of channel errors

When an output channel is activated (rising edge of the channel state), the channel errors are filtered for the period that you set using the "Surveillance-Timeout" parameter during the configuration of the module. The value of this parameter can range from 0 to 255 ms; the factory setting is 80 ms.

The filter is used to avoid premature error messages when a capacitive load is activated or an inductive load is deactivated, and during other voltage peaks when a status changes.

¹ Depending on the parameter "Digital output Restart Mode".

In static state of the output channel, that is, while the channel is permanently switched on, the filter time between error detection and the diagnostic message is typically 5 ms.

The device sends the following PROFINET diagnostic message in this fault case:

Channel number of diagnostics	0x05 - 0x08
Channel related diagnostic code	0x1810
Channel related diagnostic code message	Short circuit at I/Q

8.6 Overload/short circuit of the Type B port aux. power supply

8.6.1 For LioN-P 30 devices

In case of an overload or a short circuit between pin 2 and pin 5 on these ports (X5 - X8), the following group diagnostic message (non-channel-specific) is generated:

Channel number of diagnostics	0x8000 (diagnosis not channel-specific)
Channel related diagnostic code	0x180F
Channel related diagnostic code message	Master/Port diagnosis - Short circuit at P24 (Class B)

8.6.2 For LioN-P 60 devices

In case of an overload or a short circuit between pin 2 and pin 5 on these ports (X5 - X8), the following channel-specific diagnostic message is generated:

Channel number of diagnostics	0x05 - 0x08
Channel related diagnostic code	0x180F
Channel related diagnostic code message	Master/Port diagnosis - Short circuit at P24 (Class B)

8.7 IO-Link C/Q error

If an IO-Link Device in COM mode is unplugged, an incorrect IO-Link Device is plugged in, or an electrical fault occurs on the C/Q (Pin 4) line, for example, due to a short circuit, then following error message is generated:

Channel number of diagnostics	0x01 - 0x08
Channel related diagnostic code	0x1800
Channel related diagnostic code message	Master/Port diagnosis - No Device/communication lost
or	or
Standard diagnosis	Hardware component removed or missing

8.8 IO-Link Device Diagnostics

Diagnostics of IO-Link Device modules that the device sends to the IO-Link Master are reported via a standard channel diagnostic and an extended channel diagnostic.

Standard channel diagnostic message:

Channel number of diagnostics	0x01 - 0x08
Channel related diagnostic code	Depends on IO-Link Device diagnostics
Channel related diagnostic code message	Depends on IO-Link Device diagnostics

Extended channel diagnostic message:

Channel number of diagnostics	0x01 - 0x08
Ext. channel related diagnostic code	IO-Link Device event code

Event Code

Diagnostic code reported by the IO-Link Device. Use the IO-Link Device documentation to interpret the error message.

Channel Number

1 - 8 of the IO-Link Master port whose connected device is reporting an error.

9 IO-Link Device Configuration Tool

The TMG TE GmbH IO-Link Device Tool (V5.x or higher) is a PC software for the parameterization of IO-Link Device modules via the Belden IO-Link Master. The engineering software communicates via UDP over the Ethernet interface of the IO-Link Master. Therefore no additional hardware neither a running real time protocol is needed.

The tool can be used both as a standalone program or can be called up via TCI (Tool Calling Interface) in PLC programming software such as STEP 7 or TIA Portal®.

The key technological element for the operation of the connected devices and master is the mandatory IODD (IO Device Description) and the IOLM (IO-Link Master description) file.

The IO-Link Device Tool supports IO-Link V1.0 (IODDs V1.0.1) and IO-Link V1.1 (IODDs V1.1).

Main functions:

- ▶ IO-Link Device project management
- ▶ Port configuration of IO-Link Master modules (without connected real-time controller)
- ▶ Operation and configuration of IO-Link Device modules via IODD

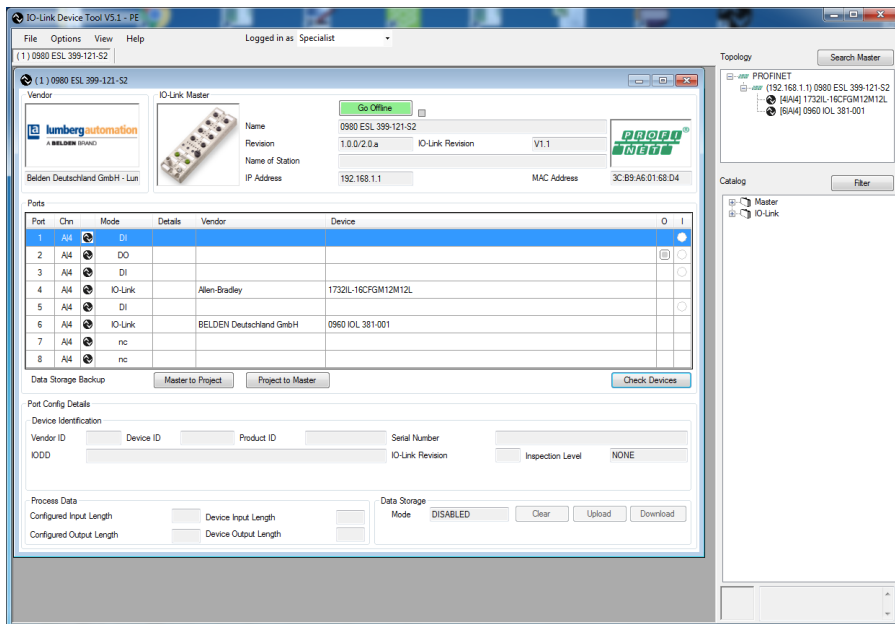

Figure 51: Port configuration tool - Main window

10 The integrated web server

The LioN-P modules are equipped with an integrated web server which makes functions available for the configuration of modules and display of status and diagnostic information.

The web interface provides an overview of the configuration and status of the module. Also, certain settings can be made. It is also possible to use the web interface to trigger a reboot, reset to the factory defaults, or perform a firmware update.

Enter `http://` followed by the IP address, such as `http://192.168.1.5`, in your web browser's address bar. If the Status page of the module is not displayed, check your browser and firewall settings.

10.1 The Status page

lumberg automation
A BELDEN BRAND

LioN-P Webserver

Status Ports System User Contact

Status

Device Overview

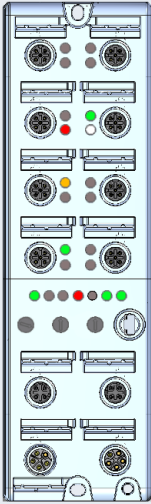

Device Information

Name 0980 ESL 399-121-S2

Bus **ON**

Device Diagnosis

IO-Link Master Diagnosis

Port Information

Port	Type	Pin / Channel	Function	State	Dia	Details
X1	IO-Link Class A + Di	4 / A	Digital Input 1 Bit In / NO	OFF		ⓘ
		2 / B	Digital Input 1 Bit In / NO	OFF		
X2	IO-Link Class A + Di	4 / A	Digital Output 1 Bit Out	OFF	DIA	ⓘ
		2 / B	Digital Input 1 Bit In / NO	OFF		
X3	IO-Link Class A + Di	4 / A	Digital Input 1 Bit In / NO	ON		ⓘ
		2 / B	Digital Input 1 Bit In / NO	OFF		
X4	IO-Link Class A + Di	4 / A	IO-Link (COM3) 4 Bytes In, 4 Bytes Out	Operate		ⓘ
		2 / B	Digital Input 1 Bit In / NO	OFF		
X5	IO-Link Class B + DO	4 / A	Digital Input 1 Bit In / NO	OFF		ⓘ
		2 / B	Inactive			
X6	IO-Link Class B + DO	4 / A	IO-Link (COM3) 4 Bytes In, 4 Bytes Out	Operate		ⓘ
		2 / B	AUX Power			
X7	IO-Link Class B + DO	4 / A	Inactive			ⓘ
		2 / B	Inactive			
X8	IO-Link Class B + DO	4 / A	Inactive			ⓘ
		2 / B	Inactive			

The status page provides a quick overview of the current state of the module.

The left side shows a graphical representation of the module with all its LEDs and the positions of the rotary encoding switches.

The right side shows the "Device Information" table with some basic data for the module; for example, the variant, the cyclic communication status and a diagnostic indicator. The indicator shows whether diagnostics for the module exist.

The "Port Information" table shows the configuration and state of all the module's IO ports.

10.2 The Ports page



LiON-P Webserver

Status Ports System User Contact

Port Details

Show details for port

X1 X2 X3 X4 X5 X6 X7 X8

Port Information		IO-Link	
Port	X6	Vendor ID	0x16a / (dec: 362)
Type	IO-Link Class B + DO	Device ID	0x381001
Dia		Vendor Name	BELDEN Deutschland GmbH
Port Diagnosis		Vendor Text	www.beldensolutions.com
Pin 4 / Channel A		Product Name	0960 IOL 381-001
Function	IO-Link (COM3)	Product ID	93492001
State	4 Bytes In, 4 Bytes Out Operate	Product Text	LiON-P IO-Link I/O-Hub, 16DI
Pin 2 / Channel B		Serial No.	0
Function	AUX Power	HW Revision	V1.0.0.0
State		FW Revision	V2.0.0.0
		Speed	COM3
		Application Name (Tag)	Belden <input type="text"/> <input type="button" value="Set"/>
		Input Data	<input type="text" value="00 00 00 00"/> <input type="button" value="Hex"/>
		Output Data	<input type="text" value="00 00 00 00"/> <input type="button" value="Hex"/>
		Parameter Read/Write	Index: 24 Subindex: 0 <input checked="" type="radio"/> Dec <input type="radio"/> Hex <input type="button" value="Read"/> <input type="button" value="Write"/> System Command <input type="text" value="Belden"/> <input type="button" value="Tx"/>

Detailed port information is shown here.

Port Diagnostics show incoming and outgoing diagnostics in clear text. **Pin 2** and **Pin 4** contain information about the configuration and state of the port. For IO-Link ports, additional information relating to the connected sensor and the process data is displayed.

10.3 The System page



LioN-P Webservice

Status Ports System User Contract

System

General Information		IP Settings	
Firmware		Parameter Settings	
Name	LioN-P PROFINET S2 IOL Master	IP-Address	192 .168 .1 .1
Version	1.0.0.42-S2 (App) / V1.0.0.0 (RT Protocol) / (RC10001-V5) / Web: 16	Subnet Mask	255 .255 .255 .0
Device		Gateway	192 .168 .1 .1
Name	0980 ESL 399-121-S2	Remanent config (Only PROFINET)	<input type="checkbox"/>
Ordering Number	935 021 004	<input type="button" value="Submit"/>	
Hardware	V1.0	Result	
Serial Number	00102		
Production Date	week: 12, 2020		
Ethernet			
MAC Address	3C B9 A6 01 68 D4		
Port 0	100Mbit full duplex		
Port 1	Link down		
Network			
IP-Address	192.168.1.1		
Subnetmask	255.255.255.0		
Gateway	192.168.1.1		
Fieldbus			
Name of Station	xd0980-esl-399-121-s2405b		
State	Communicating		
Restart device			
<input type="checkbox"/> Confirm to restart the device. All connections will be closed.			
<input type="button" value="Restart"/>			
Reset configuration to factory defaults			
<input type="checkbox"/> Confirm to reset the device. All configuration data will be overwritten by default values!			
<input type="button" value="Factory Reset"/>			
Firmware update			
<input type="button" value="FW-Update"/>			

The System page shows basic information for the module. The firmware name and its version can be viewed below **Firmware**.

All the information about the module itself is located below **Device**.

On this page you have the option to access the following values and parameters:

Restart Device

The module initializes a software reset.

Reset to Factory Settings

The module restores to the default factory settings.



Attention: During the factory reset process the BF/MS/RUN LED is cyclic triple flashing red. After completion the factory reset the BF/MS/RUN LED is cyclic triple flashing green. Afterwards perform a power cycle and wait 10 seconds.

Firmware Update

The module initializes a Firmware update.

For a firmware update choose the *.ZIP container available on our website or ask our support team. Afterwards follow the instructions shown on your screen.

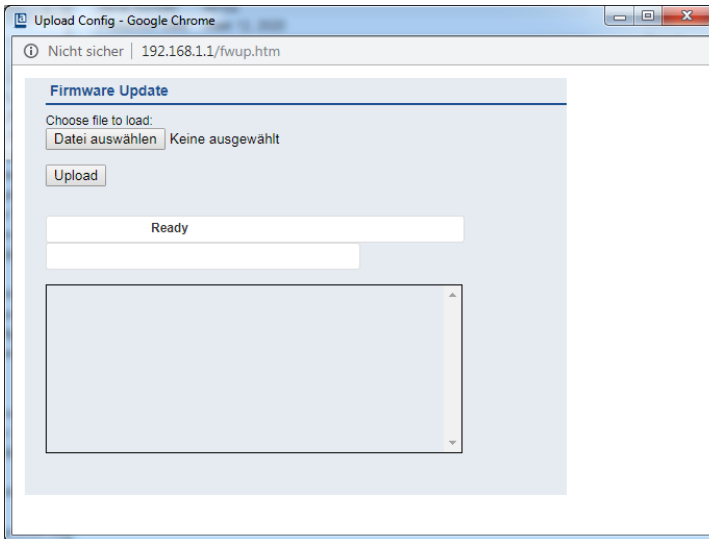

10.4 The User page

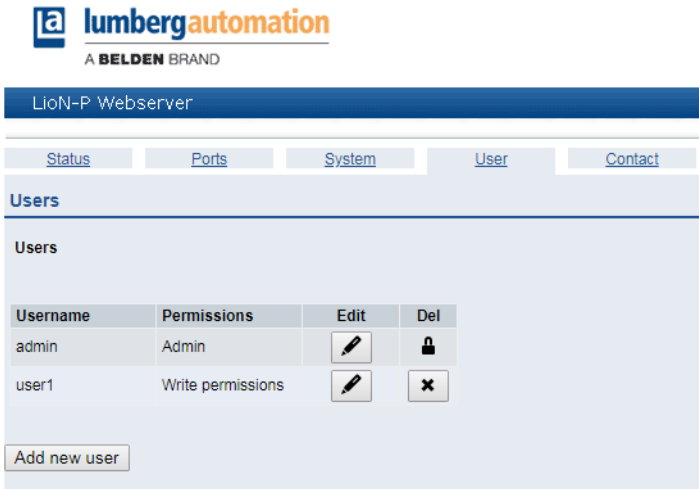

The User page provides the user management of the web interface. New users with access rights **Admin** or **Write** can be added here. For security reasons please change the default admin password immediately after configuring the device.

Default user login data:

- ▶ User: admin
- ▶ Password: private

11 Technical data

11.1 General

Protection class (This only applies if the connectors are screwed together or if protective caps are used.) ²	For all Digital LioN-P modules:	IP65, IP67
	Only for modules with M12-L power connector (not for modules with 7/8" power connector):	IP69
Ambient temperature (Operation)	-4° F to +158° F (-20° C to +70° C)	
Ambient temperature - EEC variants (Operation)	-40° F to +158° F (-40° C to +70° C)	
Weight	LioN-P 30:	480g
	LioN-P 60:	500g
Ambient moisture	max. 98% RH (for U _L certification: max. 80% RH)	
Housing material	Die-cast zinc	
Surface finish	Matt nickel	
Flammability class	UL 94 (IEC 61010)	
Vibration resistance (oscillation) DIN EN 60068-2-6 (2008-11)	15 g / 5-500 Hz	
Shock resistance DIN EN 60068-2-27 (2010-02)	50 g / 11 ms +/- X,Y,Z	
Torques	M4 fixing screws:	1 Nm
	M4 ground connection:	1 Nm
	M8 connector:	0.5 Nm
	M12 connector:	0.5 Nm

Table 38: General information

² Not under UL investigation.

11.2 PROFINET protocol

Protocol	PROFINET IO device V2.35
Conformance Class	C (CC-C)
Netload Class	2
Update cycle	1 ms
GSDML file	GSDML-V2.3x-LumbergAutomation-LioN-Pyyyyymmdd.xml
Transmission rate	100 Mbit/s, full duplex
Transmission procedure Autonegotiation	100BASE-TX is supported
Vendor ID	16A _H
Device ID	0x0380 (same for all LioN-P modules with S2 function)
Supported Ethernet protocols	Ping ARP LLDP SNMPv1 (network diagnostics) <ul style="list-style-type: none"> ▶ Read Community: public ▶ Write Community: private DCP HTTP TCP/IP MRP Client
PROFINET feature	Fast Start-UP Shared Device
Switch functionality	Integrated IRT is supported
PROFINET interface Connections Autocrossing	2 M12 sockets, 4-pin, D-coded (see pin assignments) 2 M12 Hybrid male/female, 8-pin is supported
Electrically isolated Ethernet ports -> PE	2000 V DC

Table 39: PROFINET protocol

11.3 Power supply of the module electronics/sensors

Nominal voltage U_S	24 V DC (SELV/PELV)	
Voltage range	18-30 V DC	
Power consumption of module electronics	at 24 V DC:	typ. 95 mA
	at 30 V DC:	typ. 120 mA
Voltage level of the sensor power supply	Min. ($U_S - 1.5$ V)	
Current consumption sensor system (L+ / Pin 1)	max. 500 mA per port (at ambient = 30° C) (for U_L application 400 mA)	
Short circuit/overload protection of sensor ver.	Yes, per port	
Reverse polarity protection	Yes	
Operational indicator (U_S)	LED green:	$18 \text{ V } (+/- 1 \text{ V}) < U_S < 30 \text{ V } (+/- 1 \text{ V})$
	LED red:	$U_S < 18 \text{ V } (+/- 1 \text{ V})$ or $U_S > 30 \text{ V } (+/- 1 \text{ V})$
Port X03, X04 or Port X01, X02 (LioN-P 30 devices only)	M12 power, connector/socket, 5-pole M12 hybrid, connector/socket, 8-pole	

Table 40: Information on the power supply of the module electronics/sensors

11.4 Power supply of the type B ports (auxiliary supply)

Nominal voltage U_{Aux}	24 V DC (SELV/PELV)
Voltage range	18-30 V DC
Reverse polarity protection	Yes
Operational indicator (U_{Aux})	LED green: $18\text{ V (+/- 1 V)} < U_{Aux} < 30\text{ V (+/- 1 V)}$ LED red: $U_{Aux} < 18\text{ V (+/- 1 V)}$ or $U_{Aux} > 30\text{ V (+/- 1 V)}$ * if "Report U_{Aux} supply voltage fault" is enabled.
Port X03, X04 or Port X01, X02 (LioN-P 30 devices only)	M12 power, connector/socket, 5-pole M12 hybrid, connector/socket, 8-pole

Table 41: Information on the power supply of the type B ports (auxiliary supply)

11.5 IO-Link Master Ports (X1 - X8, Ch. A / C/Q / Pin 4)

Port X01 – X08 or Port X01, X08 (LioN-P 30 devices only)	M12 socket, 5-pin M8 socket, 5-pin
--	---

Table 42: IO-Link Master Ports (X1 - X8, Ch. A / C/Q / Pin 4)

11.5.1 Configured as a digital input

Input connection	Type 1 as per IEC 61131-2
Nominal input voltage	24 V DC
Input current	Typically 3 mA
Channel type	Normally open, p-switching
Number of digital inputs	8
Status indicator	Yellow LED
Diagnostic indicator	Red LED per channel

Table 43: IO-Link Master Ports configured as digital inputs

11.5.2 Configured as a digital output (except 0980 ESL 3x8-121)



Attention: Power is supplied to the 500 mA outputs via the U_S power supply.

Output type	Normally open, p-switching
Nominal output current per channel	
Signal status "1"	Min. ($U_S - 1 V$)
Signal status "0"	max. 2 V
Max. output current per device	16 A (M12 Power) (for U_L application 9 A) 6 A (M12 Hybrid)
Short-circuit/overload protected	yes/yes
Behavior in case of short circuit or overload	Disconnection with automatic power on
Number of digital outputs	LioN-P 30: max. 8 (Pin 4) LioN-P 60: max. 8 (Pin 4) + 4 (Pin 2)
Status indicator	LED yellow per output
Diagnostic indicator	Red LED per channel

Table 44: IO-Link Master Ports configured as digital outputs

11.5.3 Configured as an IO-Link port in COM mode

IO-Link Master specification	v1.1, IEC 61131-9
Communication rates	4.8 kbaud (COM 1), 38.4 kbaud (COM 2) and 230.4 kbaud (COM 3)
Line lengths in the IO-Link Device	max. 20 m
Number of IO-Link ports (type A/type B)	8
Number of type A ports (X1, X2, X3, X4)	4
Number of type B ports (X5, X6, X7, X8)	4

Table 45: As an IO-link port in COM mode

11.6 Digital inputs (X1 – X4, type A ports, Ch. B/Pin 2)

Input connection	Type 1 as per IEC 61131-2
Nominal input voltage	24 V DC
Input current	Typically 3 mA
Channel type	Normally open, p-switching
Number of digital inputs	4
Status indicator	LED white
Diagnostic indicator	Red LED per channel
Port	M12 socket, 5-pin M8 socket, 5-pin

Table 46: Digital inputs (X1 – X4, type A ports, Ch. B/pin 2)

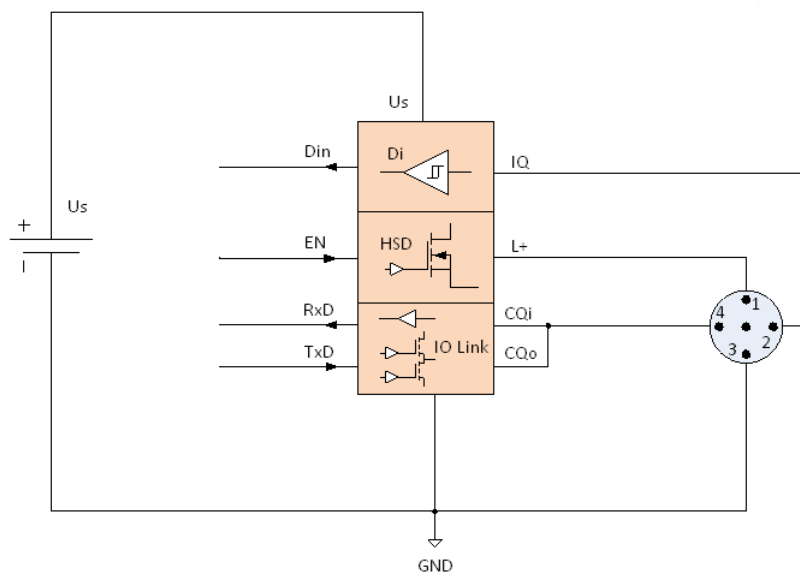

Figure 52: Block diagram Class-A Port

11.7 LioN-P 60: U_{Aux} config. as a digital output (X5 - X8, type B ports, Ch. B/Pin 2)

Output type	Normally open, p-switching
Nominal output current per channel Signal status "1" Signal status "0" (0980 ESL 3x9-121)	2 A (for U_L application 1.8 A) max. 2 A max. 1 mA
Nominal output current per channel Signal status "1" Signal status "0" (0980 ESL 3x8-121)	1.6 A max. 1.6 A max. 1 mA
Signal level of the outputs Signal status "1" Signal status "0"	min. ($U_{Aux} - 1 V$) max. 2 V
Max. output current per device	16 A (M12 Power) (for U_L application 9 A) 6 A (M12 Hybrid)
Short-circuit/overload protected	yes/yes
Filter time in case of signal change	0 - 255 ms, default setting 80 ms
Behavior in case of short circuit or overload	Disconnection without automatic power on
Number of digital outputs	4
Status indicator	LED white per output
Diagnostic indicator	Red LED per channel

Table 47: LioN-P 60 digital 2-A outputs (X5 - X8, type B ports, Ch. B/Pin 2)

11.8 LioN-P 30: U_{Aux} (X5 - X8)

Nominal output current per module	max. 4 A
Nominal output current per port	max. 4 A
Short-circuit/overload protected	yes/yes
Status indicator	LED white per output
Diagnostic indicator	Red LED per channel

Table 48: LioN-P 30 extended sensor supply (X5 - X8) type B ports

11.9 Differences between 0980 ESL 3x8-121 and 0980 ESL 3x9-121

Module type 0980 ESL 3x8-121 contains digital outputs electrically decoupled by series diodes in order to prevent unwanted reverse feeding of the sensor / actuator power supply caused by erroneous wiring.

The following block diagrams illustrate the different module types.

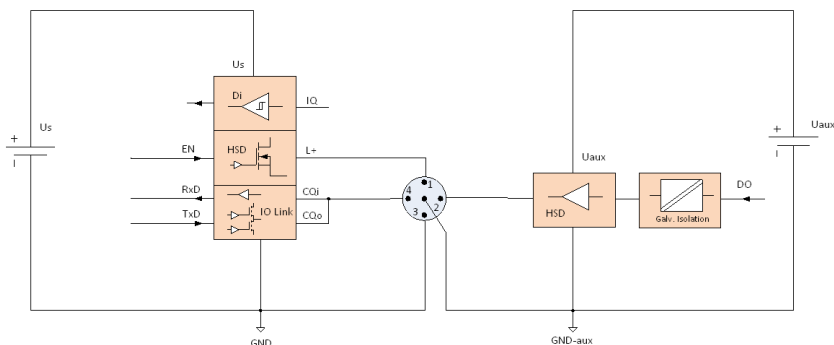

Figure 53: Block diagram Class-B Port, variant 0980 ESL xx9-xxx

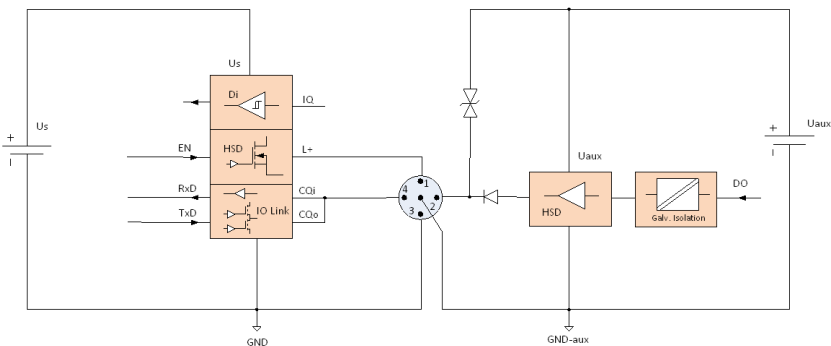

Figure 54: Block diagram Class-B Port, variant 0980 ESL xx8-xxx

11.10 LEDs

U _{Aux}	Green	Auxiliary sensor/actuator voltage $18\text{ V (+/- 1 V)} < U_{\text{Aux}} < 30\text{ V (+/- 1 V)}$
	Red*	Auxiliary sensor/actuator voltage $U_{\text{Aux}} < 18\text{ V (+/- 1 V)}$ or $U_{\text{Aux}} > 30\text{ V (+/- 1 V)}$ * if "Report U _{Aux} supply voltage fault" is enabled.
	off	None of the above conditions
U _S	Green	System/sensor voltage $18\text{ V (+/- 1 V)} < U_{\text{S}} < 30\text{ V (+/- 1 V)}$
	Red	System/sensor voltage $U_{\text{S}} < 18\text{ V (+/- 1 V)}$ or $U_{\text{S}} > 30\text{ V (+/- 1 V)}$
	off	None of the above conditions
X1 ... X8 A	Green	IO-Link COM Mode: IO-Link communication exists
	Flashing green	IO-Link COM Mode: No IO-Link communication.
	Yellow	Standard-IO Mode: Status of digital input or output on C/Q (pin 4) line "on"
	off	None of the above conditions
X1 ... X8 B	White	Status of digital input on pin 2 line "on" (or: DO or Auxiliary supply "on")
	Red	Short circuit on C/Q (pin 4) line
	Red	All modes: Overload or short circuit on L+ (pin 1) line
	off	None of the above conditions
P1 Lnk/ Act P2 Lnk/ Act	Green	Ethernet connection to another subscriber exists. Link detected.
	Flashing yellow	Data exchange with another subscriber.
	off	No connection to another subscriber. No link, no data exchange.
BF	Red	Bus fault. No configuration, no or slow physical connection
	Red flashing at 2 Hz	Link exists but no communication link to the PROFINET controller
	off	PROFINET controller has established an active connection to the device

DIA	Red	PROFINET diagnostic alarm active
	Red flashing at 1 Hz	Watchdog time-out; fail safe mode is active
	Red flashing at 2 Hz, 3 sec	DCP signal service is initiated via the bus
	Red double flash	Firmware update
	off	None of the above conditions

Table 49: Information on the LED colors

12 Accessories

In order to get access to various types of accessories, please visit our web page:

<http://www.beldensolutions.com>