





Manual

PROFIsafe

LioN-Safety 8/4-F-DI, 4-F-DO, 2-IOLM M12 (PROFINET/PROFIsafe)
0980 SSL 3031-121-007D-101



LioN-Safety 16/8-F-DI M12 (PROFINET/PROFIsafe)
0980 SSL 3030-121-007D-101

Contents

1 About this manual	11
1.1 General information	11
1.2 Explanation of symbols	12
1.2.1 Use of danger information	12
1.2.2 Use of general information	12
1.2.3 Use of the Functional Safety symbol	12
1.3 Version information	13
2 Safety instructions	14
2.1 Intended use	14
2.2 Qualified personnel	15
2.3 FS certifications 	16
2.4 Underlying technical standards	16
3 Designations and synonyms	17
4 System description	21
4.1 About LioN-X	21
4.2 About LioN-Safety 	22
4.3 Device variants 	22
4.4 I/O port overview 	23
5 Overview of product features	25

5.1 PROFINET/PROFIsafe product features	25
5.2 I/O port features	28
5.3 Integrated Web server	29
5.4 Security features	30
5.5 Other features	31

6 Assembly and wiring **32**

6.1 General information	32
6.2 Outer dimensions	33
6.2.1 LioN-Safety Mixmodule 	33
6.2.2 LioN-Safety DI variant 	34
6.2.3 Notifications	35
6.3 Port assignments	36
6.3.1 Ethernet ports, M12 socket, 4-pin, D-coded	36
6.3.2 Power supply with M12 power L-coded	37
6.3.3 I/O ports as M12 sockets 	38

7 Starting operation **40**

7.1 GSDML file	40
7.2 MAC addresses	40
7.3 State on delivery	41
7.4 Setting the rotary encoding switches 	42
7.5 SNMPv1	43





8 Configuration and operation with SIEMENS TIA Portal® **44**

8.1 Assigning a device name and IP address	46
8.2 Configuring LioN-Safety devices 	48
8.2.1 Module 0980 SSL-3030-121-007D 	48

8.2.2 Module 0980 SSL-3031-121-007D	49
8.2.3 Deleting the configuration of a specified IO-Link channel	50
8.2.4 Creating an IO-Link channel configuration	51
8.3 Parameterization of the Global Device Module	54
8.3.1 General Device Settings	55
8.3.2 I/O mapping configuration	55
8.3.3 General diagnostic settings	57
8.4 Parameterization of the Safety I/O module	58
8.4.1 Module parameters	58
8.4.2 PROFIsafe parameters	66
8.4.2.1 F_Source_Add	66
8.4.2.2 F_Dest_Add	66
8.4.2.3 F_WD_Time	67
8.4.2.4 F_iPar_CRC	67
8.5 Parameterization of the Status/Control Module	70
8.5.1 General Device Settings	71
8.5.2 I/O mapping configuration of Status/Control data	73
8.5.3 General Diagnostic Settings	74
8.6 Parameterization of the I/O ports X7 .. X8	74
8.6.1 Enhanced port parameters	76
8.6.2 Failsafe port parameters for Ch. A in IO-Link mode	80
8.6.3 Standardized port parameters	83
8.7 IO-Link Device Parameterization	91
8.7.1 SIEMENS IO-Link library	91
8.7.1.1 SIEMENS function block FB50004 – write example	93
8.7.1.2 SIEMENS function block FB50004 – read example	95
8.7.2 SIEMENS WRREC and RDREC	97
8.7.2.1 Write sequence	97
8.7.2.2 Read sequence	104
8.7.2.3 Error PDU for the Read/Write sequence	111
8.8 Media Redundancy Protocol (MRP)	113
8.9 Identification & maintenance (I&M)	115
8.9.1 Supported I&M features	115
8.9.1.1 I&M data of the PN-IO Device	115









8.9.1.2 I&M 4 data of the Safety module	118
8.9.1.3 I&M data of the IOL-Master proxy (Status/Control Module)	119
8.9.1.4 I&M data of the IOL-Device proxy	121
8.9.2 Reading and writing I&M data	123
8.9.2.1 I&M Read Record	124
8.9.2.2 I&M Write Record	128
8.10 Fast Start Up (FSU) / Prioritized Startup	130
8.11 Suspend / Resume of IO-Link port operation	132
8.11.1 Automatic tool changer application use case	132
8.11.2 Concept	132
8.11.3 Use cases	134
8.11.4 Suspend and Resume cycle	135
8.11.4.1 Write Record Suspend – port command	135
8.11.4.2 Read Record Suspend – port status	136
8.11.4.3 Write Record Resume – port command	138
8.11.4.4 Read Record Resume – port status	139
8.12 Acknowledge Re-Integration 	141

9 Process data assignment 143

9.1 Process data Global Device Module	143
9.1.1 Mode 1	143
9.1.2 Mode 2	144
9.2 Process data 16/8-F-DI 	145
9.2.1 Digital input data in One Channel Mode 	145
9.2.2 Digital input data in Two Channel Mode 	146
9.3 Process data 8/4-F-DI, 4-F-DO 	148
9.3.1 Digital input data in One Channel Mode	148
9.3.2 Digital input data in Two Channel Mode 	149
9.3.3 Digital output data	151
9.4 Process data Status DI/Control DO	151
9.4.1 Status/Control data with assignment	153
9.4.1.1 Digital Input Mode 1	153











9.4.1.2 Digital Output Mode 1	153
9.4.1.3 Digital Input Mode 2	154
9.4.1.4 Digital Output Mode 2	154
9.5 Process data IO-Link ports, Slot 3.2 .. 3.3	155
9.6 Process data mirrored Global Device Module	158
9.7 Process data mirrored Safety Module	158
9.7.1 16/8-F-DI	158
9.7.1.1 Digital input data in One Channel Mode	158
9.7.1.2 Digital input data in Two Channel Mode	159
9.7.2 8/4-F-DI	160
9.7.2.1 Digital input data in One Channel Mode	160
9.7.2.2 Digital input data in Two Channel Mode	160
9.8 Process data mirrored IO-Link Master	161

10 Functional Safety I/O modes **162**





10.1 F-DI modes overview 	162
10.1.1 SIL 2, PL d, Cat. 2 (with external test interval) 	163
10.1.2 SIL 2, PL d, Cat. 2 	167
10.1.3 SIL 3, PL d, Cat. 3 (with external test interval) 	171
10.1.4 SIL 3, PL e, Cat. 4 	173
10.2 F-DO modes overview 	176
10.2.1 SIL 3, PL e, Cat. 4 with two redundant F-DOs 	177
10.2.2 SIL 3, PL e, Cat. 4 with two redundant actuators 	178

11 PROFIsafe Configurator App **179**

12 PDCT interface **181**

13 Diagnostics	182
13.1 Detailed diagnostics description	182
13.1.1 Detected error of the system/sensor power supply U_S	182
13.1.2 Detected error of the actuator power supply U_L	183
13.1.3 Overtemperature	184
13.1.4 Overload/short-circuit of the I/O port sensor supply outputs	184
13.1.5 Detected discrepancy error on safety inputs	185
13.1.6 Overload/short circuit of Ch. A for X5 .. X6 F-DO	186
13.1.7 Overload/short circuit of Ch. B for X5 .. X6 F-DO	187
13.1.8 Overload/short circuit of Ch. A for X7 .. X8 DO	187
13.1.9 Overload/short circuit of Ch. B for X7 .. X8 DO	188
13.1.10 IO-Link C/Q error detection	190
13.1.11 Generic parameter error detection	190
13.1.12 Process data mismatch error detection	191
13.1.13 Force mode diagnostic	191
13.1.14 Internal module error detected	192
13.2 Table of IO-Link Master diagnostic codes	193
13.3 IO-Link Device diagnostics in PROFINET	196
13.4 Table of IO-Link Device diagnostic codes	197
13.5 Error detection behavior of F-I/O 	199
13.5.1 Detected errors in failsafe digital inputs (F-DI) 	199
13.5.2 Detected errors in failsafe digital outputs (F-DO) 	200
13.5.3 Detected errors in failsafe communication 	201
13.5.4 Internal worst case delay time for F-DI of 0980 SSL 303x... 	201
13.5.5 Total worst case delay time for F-DI 	201
13.5.6 Internal worst case delay time for F-DO of 0980 SSL 303x... 	202
13.5.7 Total worst case delay time for F-DO 	203
13.5.8 Total worst case delay time (TWCDDT) 	203
13.5.9 Safety Function Response Time (SFRT) 	204

14 IIoT functionality	206
14.1 MQTT	207
14.1.1 MQTT configuration	207
14.1.2 MQTT topics	210
14.1.2.1 Base topic	210
14.1.2.2 Publish topic	213
14.1.2.3 Command topic (MQTT Subscribe)	218
14.1.3 MQTT configuration - Quick start guide	222
14.1.3.1 MQTT configuration via JSON	222
14.2 OPC UA	224
14.2.1 OPC UA configuration	225
14.2.2 OPC UA address space	227
14.2.3 OPC UA configuration - Quick start guide	228
14.2.3.1 OPC UA configuration via JSON	228
14.3 REST API	230
14.3.1 Standard device information	232
14.3.2 Structure	233
14.3.3 Configuration and forcing	239
14.3.4 Reading and writing ISDU parameters	241
14.3.4.1 Reading ISDU	241
14.3.4.2 Writing ISDU	243
14.3.5 Example: Reading ISDU	245
14.3.6 Example: Writing ISDU	245
14.4 CoAP server	246
14.4.1 CoAP configuration	246
14.4.2 REST API access via CoAP	247
14.4.3 CoAP configuration - Quick start guide	250
14.4.3.1 CoAP configuration via JSON	250
14.5 Syslog	252
14.5.1 Syslog configuration	252
14.5.2 Syslog configuration - Quick start guide	255
14.5.2.1 Syslog configuration via JSON	255
14.6 Network Time Protocol (NTP)	257

14.6.1 NTP configuration	257
14.6.2 NTP configuration - Quick start guide	259
14.6.2.1 NTP configuration via JSON	259
15 The integrated Web server	261
15.1 The Status page	262
15.2 The Ports page	263
15.3 The System page	264
15.4 The User page	266
16 IODD	267
16.1 IO-Link Device parameters and ISDU requests	267
16.2 Web GUI functionality	268
16.2.1 Port Details page	268
16.2.2 Parameters page	270
16.2.3 IODD Management page	271
17 Technical data	272
17.1 Safety codes 	273
17.2 General	275
17.3 PROFINET protocol	276
17.4 Power supply of the module electronics/sensors 	277
17.5 Power supply of the actuators	279
17.6 FS DI ports 	280
17.7 FS DO ports 	281
17.8 IO-Link Master ports Class A	282
17.8.1 Configured as digital input (Pin 4 + Pin 2)	282
17.8.2 Configured as digital output (Pin 4 + Pin 2)	283
17.8.3 Configured as IO-Link port in COM mode (Pin 4)	284
17.9 LEDs	285

17.10 Data transfer times for non-Safety I/O	287
18 Recycling note	289
19 Accessories	290
20 Declarations of conformity	291

1 About this manual

This present language version of the manual contains the 'Original Instructions' according to the Machinery Directive (Directive 2006/42/EC).

1.1 General information

Read the assembly and operating instructions on the following pages carefully before starting up the modules. Keep this information where it is accessible to all users.

The texts, figures, diagrams, and examples used in this document are exclusively used to explain how to operate and apply the modules.

Please contact us if you have any detailed questions on installing and starting up the devices:

Belden Deutschland GmbH
– Lumberg Automation™ –
Im Gewerbepark 2
D-58579 Schalksmühle
Germany
lumberg-automation-support.belden.com
www.belden.com
catalog.belden.com

1.2 Explanation of symbols

1.2.1 Use of danger information

Danger information is denoted as follows:



Danger: Means that death, serious physical injury or substantial damage to property will occur if the required safety measures are not taken.



Warning: Means that death, serious physical injury or substantial damage to property can occur if the required safety measures are not taken.



Caution: Means that minor physical injury or damage to property can occur if the required safety measures are not taken.

1.2.2 Use of general information

General information is denoted as follows:



Attention: Contains important information on the product, on how to manage the product, or on the respective section of the documentation to which your special attention is being drawn.

1.2.3 Use of the Functional Safety symbol



Functional Safety (FS): Means that important information is provided which is required to be considered for proper usage of the described devices in this manual in a Functional Safety environment.

The yellow background color in graphics and table cells illustrates Functional Safety Inputs and Outputs.

1.3 Version information

Version	Created	Changes
1.0	08/2024	First published version including Declarations of conformity on page 291

Table 1: Overview of manual revisions

2 Safety instructions

2.1 Intended use

The products described in this manual (see [Device variants](#) on page 22) are decentralized Safety I/O modules on an Industrial Ethernet Network.

We adhere to all safety standards when developing, producing, testing, and documenting our products.

For a safe operation it is important that you follow all handling specifications and safety instructions described for the configuration, assembly and operation.

The modules fulfill the requirements of the EMC guideline (2014/30/EU) and the low voltage guideline (2014/35/EU).

The Safety I/O modules are designed to be used in the industrial sector. The industrial environment is distinguished by the fact that the consumer is not connected directly to the public low voltage network. Additional measures are required for use in residential areas or in business and commercial sectors.



Attention: This equipment may cause radio interference in residential areas. In this case the operator may be requested to carry out appropriate measures.

The proper and safe operation of this product depends on proper transportation, storage, assembly, and installation, and careful operation.

A completely assembled device housing is required for the proper operation of the Safety I/O modules.

Only connect devices that fulfill the requirements of EN 61558-2-4 and EN 61558-2-6 to the Safety I/O modules.

During the configuration, installation, start-up, maintenance, and testing of the devices, adhere to the safety and accident-prevention guidelines for the specific application.

Only install cables and accessories that fulfill the requirements and regulations for safety, electromagnetic compatibility, and, where applicable, telecommunication end devices, as well as the specification information. Information on which cables and accessories are permitted for the installation can be obtained from Belden Deutschland GmbH – Lumberg Automation™ or is contained in this manual.



Attention: Take faulty devices out of operation immediately and replace if necessary.

2.2 Qualified personnel

The configuration, installation, start-up, maintenance, and testing of the devices may only be performed by a qualified electrician who is familiar with the safety standards of the automation technology.

The personnel requirements are based on the requirement profiles described by ZVEI, VDMA, or equivalent organizations.

Only electricians who are familiar with the content of all provided device documentation are authorized to install and maintain the devices described. These are persons who

- ▶ based on their technical training, knowledge, and experience, and their knowledge of the pertinent standards, can evaluate the work to be carried out and identify any potential risks or
- ▶ based on working for several years in a related sector, have the same level of knowledge as they would have from the relevant technical training.

Only Belden Deutschland GmbH – Lumberg Automation™ – is permitted to make changes to the hardware or software of the products that go beyond the scope of this manual.



Warning: Making unqualified changes to the hardware or software, or non-adherence to the warning information contained in this document, can result in serious personal injury or damage to equipment.



Attention: Belden Deutschland GmbH accepts no liability for any damage caused by unqualified personnel or improper use. This automatically voids the warranty.

2.3 FS certifications

The Functional Safety articles 0980 SSL 3030-121-007D-101 and 0980 SSL 3031-121-007D-101 are tested and certified by:

TÜV Rheinland Industrie Service GmbH

Am Grauen Stein

51105 Köln

Germany

The articles are certified according to the standards listed below:

Standard	Titel
IEC 61508, Parts 1-7:2010	Functional safety of electrical/electronic/ programmable electronic safety-related systems
EN ISO 13849-1:2015 EN ISO 13849-1:2023 (PL e, Category 4)	Safety of machinery – Safety-related parts of control systems – Part 1: General principles for design

2.4 Underlying technical standards

Standard	Titel
IEC 61131-2:2017	Programmable Controllers - Environmental requirements and tests
IEC 61010-2-201:2017	Safety requirements for electrical equipment for measurement, control and laboratory use
IEC 61131-9	IO-Link Interface and System V1.1.3

3 Designations and synonyms

AOI	Add-On Instruction
API	Application Programming Interface
BF	Bus Fault LED
Big Endian	Data format with High-B on first place (PROFINET and IO-Link)
BUI	Back-Up Inconsistency (EIP diagnostics)
CC	CC-Link IE Field
C/Q	I/O port pin 4 mode, IO-Link communication/switching signal
Ch. A	Channel A (Pin 4) of I/O port
Ch. B	Channel B (Pin 2) of I/O port
CIP	Common Industrial Protocol (media independent protocol)
CIP Safety™	Common Industrial Protocol for Safety applications, CIP Safety™ is a registered trademark of ODVA
Class A	IO-Link port specification (Class A)
Class B	IO-Link port specification (Class B)
CoAP	Constrained Application Protocol
CSP+	Control & Communication System Profile Plus
DAT	Device Acknowledgement Time
DCP	Discovery and Configuration Protocol
DevCom	Device Communicating (EIP diagnostics)
DevErr	Device Error (EIP diagnostics)
DI	Digital Input
DIA	Diagnostic LED
DO	Digital Output
DIO	Digital Input/Output
DTO	Device Temperature Overrun (EIP diagnostics)
DTU	Device Temperature Underrun (EIP diagnostics)
DUT	Device under test

EIP	EtherNet/IP™ is a registered trademark of ODVA
ERP	Enterprise Resource Planning system
ETH	ETHERNET
FE	Functional Earth
FME	Force Mode Enabled (EIP diagnostics)
FS	Functional Safety
FSU	Fast Start-Up
GSDML	General Station Description Markup Language
High-B	High-Byte
HTTPS	Hyper Text Transfer Protocol Secure
ICE	IO-Link port COM Error (EIP diagnostics)
ICT	Invalid Cycle Time (EIP diagnostics)
IDE	IO-Link port Device Error (EIP diagnostics)
IDN	IO-Link port Device Notification (EIP diagnostics)
IDW	IO-Link port Device Warning (EIP diagnostics)
IIoT	Industrial Internet of Things
ILE	Input process data Length Error (EIP diagnostics)
IME	Internal Module Error (EIP diagnostics)
I/O	Input / Output
I/O port	X1 .. X8
I/O port pin 2	Channel B of I/O ports
I/O port pin 4 (C/Q)	Channel A of I/O ports
IODD	I/O Device Description
IOL or IO-L	IO-Link
I/Q	I/O port pin 2 mode, Digital Input/switching signal
ISDU	Indexed Service Data Unit
IVE	IO-Link port Validation Error (EIP diagnostics)
I&M	Identification & Maintenance
JSON	JavaScript Object Notation (platform independent data format)
L+	I/O port pin 1, sensor power supply

3 Designations and synonyms

LioN-X 60	LioN-X variants with a width of 60mm
Little Endian	Data format with Low-B on first place (EtherNet/IP)
LLDP	Link Layer Discovery Protocol
Low-B	Low-Byte
LSB	Least Significant Bit
LVA	Low Voltage Actuator Supply (EIP diagnostics)
LVS	Low Voltage System/Sensor Supply (EIP diagnostics)
MIB	Management Information Base
MP	Multiprotocol: PROFINET + EtherNet/IP + EtherCAT® + Modbus TCP (+ CC-Link IE Field Basic)
MQTT	Message Queuing Telemetry Transport (open networking protocol)
MSB	Most Significant Bit
M12	Metric thread according to DIN 13-1 with 12 mm diameter
NTP	Network Time Protocol
OFDT	One Fault Delay Time
OLE	Output process data Length Error (EIP diagnostics)
OPC UA	Open Platform Communications Unified Architecture (platform independent, service-oriented architecture)
PFH	Probability of dangerous Failure per Hour [h -1]
PD	Process Data
PDCT	Port and Device Configuration Tool
PLC	Programmable Logic Controller
PN	PROFINET
PWR	Power
Qualifier	Validity on a process value. Valid = "1"
REST	REpresentational State Transfer
RFC	Request for Comments
RPI	Requested Packet Interval
RWr	Word data input as seen from the master station (CC-Link)
RWw	Word data output as seen from the master station (CC-Link)
RX	Bit data input as seen from the master station (CC-Link)

RY	Bit data output as seen from the master station (CC-Link)
SCA	Short Circuit Actuator/ U_L / U_{AUX} (EIP diagnostics)
SCS	Short Circuit Sensor (EIP diagnostics)
SFRT	Safety Function Response Time
SIO mode	Standard Input Output mode
SLMP	Seamless Message Protocol
SNMP	Simple Network Management Protocol
SP	Single Protocol (PROFINET, EtherNet/IP, EtherCAT®, Modbus TCP or CC-Link IE Field Basic)
SPE	Startup Parameterization Error (EIP diagnostics)
T-B	Test Channel B
T-A	Test Channel A
U_{AUX}	$U_{Auxiliary}$, supply voltage for the load circuit (Actuator supply on Class B ports of Class A/B IO-Link Master)
UDP	User Datagram Protocol
UDT	User-Defined Data Types
UINT8	Byte in PLC (IB, QB)
UINT16	Unsigned integer with 16 bits or word in PLC (IW, QW)
U_L	U_{Load} , supply voltage for the load circuit (Actuator supply on Class A IO-Link Master)
UL	Underwriters Laboratories Inc. (certification company)
UTC	Coordinated Universal Time (Temps Universel Coordonné)
WCDT	Worst Case Delay Time

Table 2: Designations and synonyms

4 System description

The LioN modules (Lumberg Automation™ Input/Output Network) function as the interface in an industrial Ethernet system: A central controller on the management level is able to communicate with the decentralized sensors and actuators on the field level. The line or ring topologies for which LioN modules can be used ensure not only reliable data communication but also significantly reduce the number of cables required and thus also the costs for installation and maintenance. They additionally enable easy and quick extension.

4.1 About LioN-X

The LioN-X device variants convert standard input, standard output or IO-Link signals from sensors & actuators into an industrial Ethernet protocol (PROFINET, EtherNet/IP, EtherCAT®, Modbus TCP, CC-Link IE Field Basic) and/or into a cloud protocol (REST API, OPC UA, MQTT). For the first time, there is now Syslog on board. The robust 8 port housing design allows the use even in harsh environments where e.g. weld field immunity, high temperature ranges or protection class IP67 & IP69K are needed.

Use all benefits of the Lumberg Automation™ product solution by additionally downloading the configuration tool *LioN-Management Suite* from www.belden.com to enable e.g. a fast and easy parameterization of the connected IO-Link devices via the embedded IODD interpreter.

4.2 About LioN-Safety

LioN variants with Functional Safety (FS) communicate via

- ▶ PROFIsafe: a certified protocol for safe PROFINET communication according to IEC 61784-3.
- ▶ CIP Safety: a certified protocol for safe EtherNet/IP communication according to IEC 61784-3.

4.3 Device variants

The following PROFIsafe variants are available within the LioN-Safety family:

Article number	Product designation	Description	I/O port functionality
935023002	0980 SSL 3031-121-007D-101	LioN-Safety M12-60 mm, FS Mixmodule PROFINET/PROFIsafe Safety function up to SIL3, PL e, Cat 4	8/4 x F-DI + 4 x F-DO, 2 x IO-Link Class A
935023006	0980 SSL 3030-121-007D-101	LioN-Safety M12-60 mm, FS DI Module PROFINET/PROFIsafe Safety function up to SIL3, PL e, Cat 4	16/8 x F-DI

Table 3: Overview of LioN-Safety variants

4.4 I/O port overview

The following tables show the main I/O port differences of the LioN-Safety family. Pin 4 and Pin 2 of the I/O ports can be configured partly to IO-Link, Digital Input or Digital Output. The Functional Safety I/O ports in the following tables are highlighted in yellow:

LioN-Safety Mixmodule

Device variant	Port	Pin 1	Pin 2	Pin 3	Pin 4	Pin 5
0980 SSL 3031...	X8:	U_S (4 A by U_S)	DI/DO (2 A)	GND U_S	IO-Link/DI/DO (2 A by U_S)	n.c.
	X7:	U_S (4 A by U_S)	DI/DO (2 A by U_S)	GND U_S	IO-Link/DI/DO (2 A by U_S)	n.c.
	X6:	GND- U_L -T-A	DO-B (2 A by U_L)	GND U_L	DO-A (2 A by U_L)	GND- U_L -T-B
	X5:	GND- U_L -T-A	DO-B (2 A by U_L)	GND U_L	DO-A (2 A by U_L)	GND- U_L -T-B
	X4:	U_S -T-A (1.5 A by U_S)*	DI-B	GND U_S	DI-A	U_S -T-B (1.5 A by U_S)*
	X3:	U_S -T-A (1.5 A by U_S)*	DI-B	GND U_S	DI-A	U_S -T-B (1.5 A by U_S)*
	X2:	U_S -T-A (1.5 A by U_S)*	DI-B	GND U_S	DI-A	U_S -T-B (1.5 A by U_S)*
	X1:	U_S -T-A (1.5 A by U_S)*	DI-B	GND U_S	DI-A	U_S -T-B (1.5 A by U_S)*

Table 4: Port configuration of 0980 SSL 3031... variant

*) Permissible max. current per each port is 1.5 A in total after summed up U_S -T-A and U_S -T-B.

LioN-Safety DI Module

Device variant	Port	Pin 1	Pin 2	Pin 3	Pin 4	Pin 5
0980 SSL 3030...	X8:	U _S -T-A (1.5 A by U _S)*	DI-B	GND U _S	DI-A	U _S -T-B (1.5 A by U _S)*
	X7:	U _S -T-A (1.5 A by U _S)*	DI-B	GND U _S	DI-A	U _S -T-B (1.5 A by U _S)*
	X6:	U _S -T-A (1.5 A by U _S)*	DI-B	GND U _S	DI-A	U _S -T-B (1.5 A by U _S)*
	X5:	U _S -T-A (1.5 A by U _S)*	DI-B	GND U _S	DI-A	U _S -T-B (1.5 A by U _S)*
	X4:	U _S -T-A (1.5 A by U _S)*	DI-B	GND U _S	DI-A	U _S -T-B (1.5 A by U _S)*
	X3:	U _S -T-A (1.5 A by U _S)*	DI-B	GND U _S	DI-A	U _S -T-B (1.5 A by U _S)*
	X2:	U _S -T-A (1.5 A by U _S)*	DI-B	GND U _S	DI-A	U _S -T-B (1.5 A by U _S)*
	X1:	U _S -T-A (1.5 A by U _S)*	DI-B	GND U _S	DI-A	U _S -T-B (1.5 A by U _S)*

Table 5: Port configuration of 0980 SSL 3030... variant

*) Permissible max. current per each port is 1.5 A in total after summed up U_S-T-A and U_S-T-B.

5 Overview of product features

5.1 PROFINET/PROFIsafe product features

Data connection

The connection option provided by LioN-Safety is the common M12 connector with D-coding for the PROFINET IO network.

The connectors are also color-coded to prevent the ports from being mixed up.

Data transmission rates

Support of 100 Mbit/s with auto crossover and auto negotiation corresponding to IEEE 802.3.

PROFINET RT IO Device

The LioN-Safety variants support PROFINET RT (real-time). This allows the transmission of time sensitive process data between network components in real-time communication.

PROFINET specification V2.44, Conformance Class C (CC-C)

The LioN-Safety variants comply with the PROFINET specification V2.44 and meet the requirements of Conformance Class C (CC-C) for the integrated switch. This means the device can be used in PROFINET IRT networks.

PROFIsafe specification V2.6.1

The LioN-Safety variants comply with the PROFIsafe specification V2.6.1.

Integrated switch

The integrated Ethernet switch with Conformance Class C (CC-C) has two PROFINET ports and thus supports the establishment of a line or ring topology for the PROFINET IO network.

Media Redundancy Protocol

The additionally implemented Media Redundancy Protocol (MRP) enables the design of a highly available network infrastructure.

Fast Start-Up (FSU)

Fast Start-Up is an accelerated start-up process that enables LiON-Safety devices to start communicating on a PROFINET network after a very short time. This makes a faster tool change possible, for example. Thanks to the FSU feature, the network is ready to communicate in less than 2200 ms.¹

Shared Device

With the shared device functionality, two controllers can access the same I/O device via a PROFINET interface. This option is done by copying the configuration of the I/O device into the first and second controller and assigning it to the second controller as shared device. Every sub slot with I/O data can be assigned to **one** of the two PLCs which share the I/O data of the I/O device.

DCP

The devices use the DCP protocol to automatically assign IP addresses.

Net Load Class III

The devices offer advanced robustness against net load according to Net Load Class III.

LLDP

The LLDP protocol is used to detect devices in the vicinity (neighborhood detection).

SNMPv1

The SNMPv1 protocol (according PROFINET standard V2.44) handles network component monitoring and communication between Master and Device (cannot be operated stand-alone).

¹ Measured according to the specification: Internal switch is able to forward telegrams.

Alarm and diagnostic messages

The modules support extended PROFINET alarm and diagnostic messages.

I&M functions

Identification and maintenance data (I&M) are stored on the module. The identification data consist of manufacturer details for the module and can only be read. The maintenance data consist of system specific details created during the course of configuration. The modules can be uniquely identified online via the I&M data.

The device supports I&M data related to the PNO 2.832 standard (IO-Link integration for PROFINET, Edition 2):

- ▶ I&M0 ... I&M3 for the interface module (access slot, sub-slot 0x8000)
- ▶ I&M0 and I&M4 for the safety module
- ▶ I&M0 for the IO-Link Master proxy (exclusively 0980 SSL 3031-...)
- ▶ I&M0 and I&M5 for the IO-Link Device proxies (exclusively 0980 SSL 3031-...)

GSDML-based configuration and parameterization of the I/O ports

The GSDML offers the option of configuring and parameterizing the I/O ports on the master devices within an engineering tool of a PLC.

5.2 I/O port features

IO-Link specification.

LioN-Safety supports IO-Link specification v1.1.3.

IO-Link Master ports

For the LioN-Safety Mixmodule variant (0980 SSL 3031-...), there are 2 IO-Link Class A ports with additional digital inputs and outputs available. For detailed information see chapter [I/O port overview](#) on page 23.

IO-Link port connections

The IO-Link port connection option provided by LioN-Safety devices is the 5-pin M12 connector. Pin 5 is not assigned for IO-Link Class A ports.

Validation & Backup

The Validation & Backup function checks if the right device is connected and stores the parameters of the IO-Link Device. The function thus gives you an easy option for replacing the IO-Link Device.

This is possible as of IO-Link specification \geq V1.1 and only if the IO-Link Device **and** the IO-Link Master support the function.

IO-Link Device parameterization

IO-Link Device parameterization in a PROFINET network is possible with the Siemens IO_LINK_DEVICE function block (FB50004) for Siemens TIA Portal®.

LED

The status of the ports is visible by the color of the matching LEDs and their flash pattern. For details on the meanings of the LED colors, please see section [LEDs](#) on page 285.

5.3 Integrated Web server

Network parameter display

Get an overview of network parameters such as the IP address, subnet mask and gateway.

Displaying diagnostics

View diagnostics via the integrated Web server.

User management

Use the integrated Web server for convenient management of all users.

IO-Link Device parameters

You can read the parameters of the IO-Link Device and write new parameters to the IO-Link Device in single-write mode (single-write mode does not activate the automatic mechanism of the *Validation and Backup* function).

5.4 Security features

Firmware signature

The official firmware update packages contain a signature which helps prevent the system against manipulated firmware updates.

Syslog

The LioN-Safety variants support the traceability of messages centrally managed and logged via Syslog.

User manager

The Web server provides a user manager to help protect the Web interface against unauthorized access. You can manage the allowed users by the different access levels “Admin” or “Write”.

Default user settings:

User: admin

Password: private



Attention: Change the default settings to help protect the device against unauthorized access.

5.5 Other features

Interface protection

The devices have reverse polarity, short-circuit and overload protection for all interfaces.

For more details, see section [Port assignments](#) on page 36.

Failsafe

The devices support a failsafe function for non-safe I/Os of the 2-port IO-Link Master of module 0980 SSL 3031-121-007D-101. This allows you to define the behavior of every single channel configured as an output in the case of invalid PLC data (e.g. PLC in STOP) or of lost PLC communication.

Industrial Internet of Things

LioN-Safety is industry 4.0 ready and supports the integration in IIoT networks via REST API and the IIoT-relevant protocols MQTT, OPC UA and CoAP.

Color-coded connectors

The colored connectors help you avoid confusion in your cabling.

IP protection classes: IP65 / IP67 / IP69K

The IP protection class describes environmental influences that the devices can be exposed to without risk and without suffering damage or causing a risk for the user.

The whole LioN-Safety family offers IP65, IP67 and IP69K.

6 Assembly and wiring

6.1 General information

Mount the device on a flat surface using 2 screws (M4x 25/30). The torque required here is 1 Nm. Use washers for all fastening methods as per DIN 125.



Attention: The devices have a ground connection with an M4 thread for the conduction of interference currents and the EMC immunity. This is labeled with the symbol for the ground and the designation "FE".



Attention: Use a low-impedance connection to connect the device to the reference ground. When using a grounded mounting surface, you can make the connection directly via the fixing screws.



Attention: If the mounting surface is ground-free, use a ground strap or a suitable FE line (FE = Functional Earth). Use an M4 screw to connect the ground strap or the FE line to the ground point and if possible put a washer and a toothed washer below the fixing screw.

6.2 Outer dimensions

6.2.1 Lion-Safety Mixmodule ●

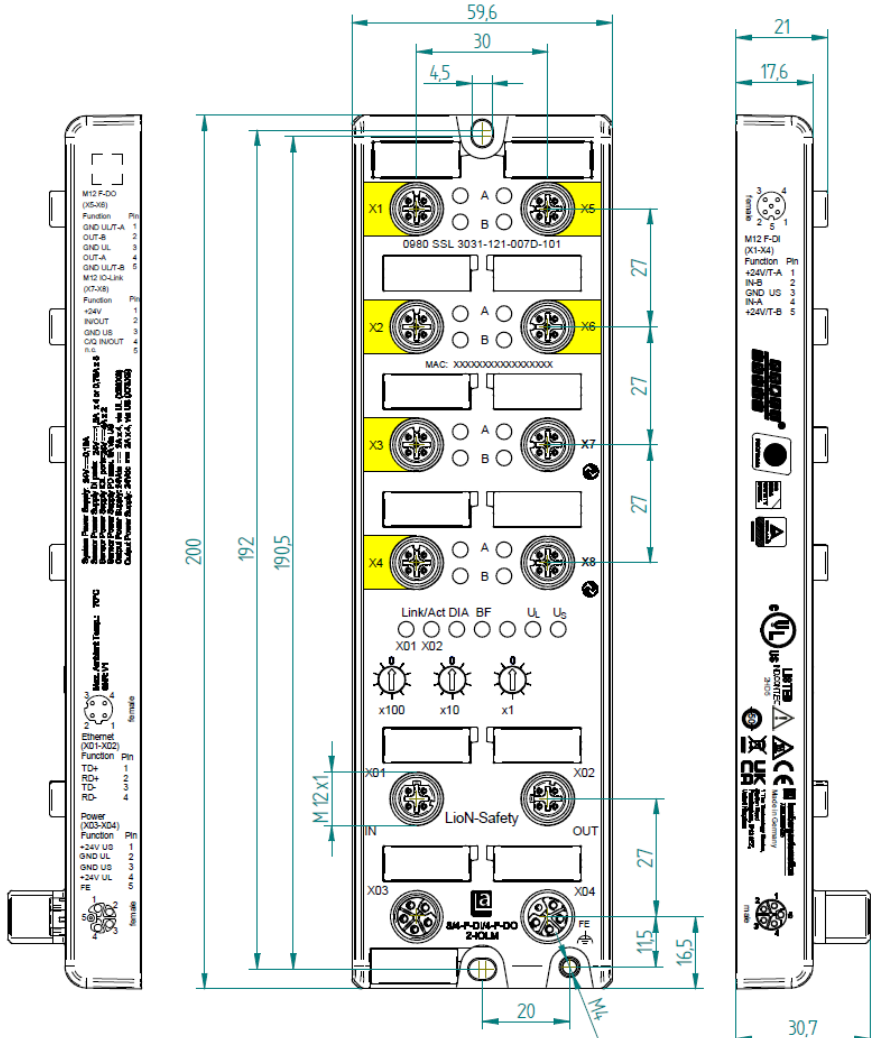

Figure 1: 0980 SSL 3031-121-007D-101

6.2.2 Lion-Safety DI variant 

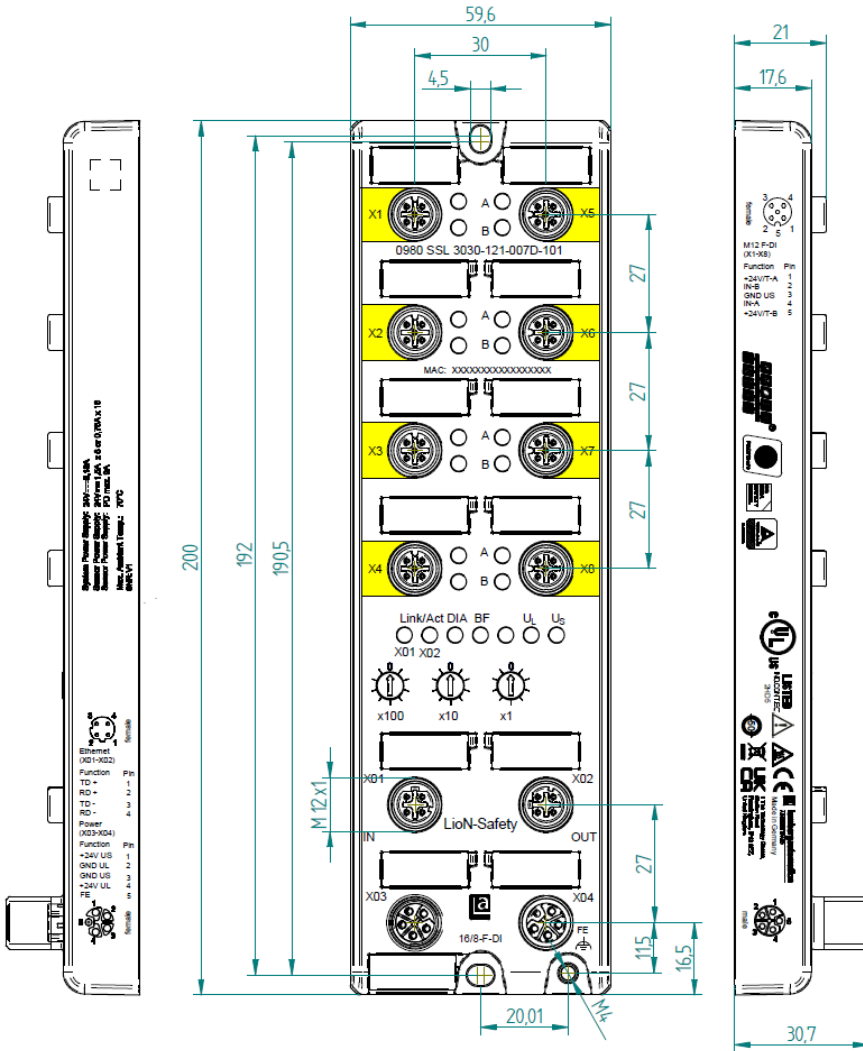

Figure 2: 0980 SSL 3030-121-007D-101

6.2.3 Notifications



Attention:

For **UL applications**: Exclusively use a UL-certified cable with a suitable evaluation to connect the devices (CYJV or PVVA). To program the control, please refer to the OEM information, and only use suitable accessories.

Only approved for interior use. Please note the maximum elevation of +3000 m ASL (+9842 ft ASL) (with derating). Approved up to a maximum soiling level of 2.



Warning: Terminals, housings field-wired terminal boxes or components can exceed temperatures of +60 °C (140 °F).



Warning: For **UL applications**: Use temperature-resistant cables with heat resistance up to at least +125 °C (257 °F) for every LioN-Safety variant.



Warning: Observe the following maximum output power for the sensor supply of the devices:

Max. 4.0 A per port; for **UL applications** max. 5.0 A in total for port pair X7/X8 and max. 9.0 A in total (with derating) for the whole port group X1 .. X8.

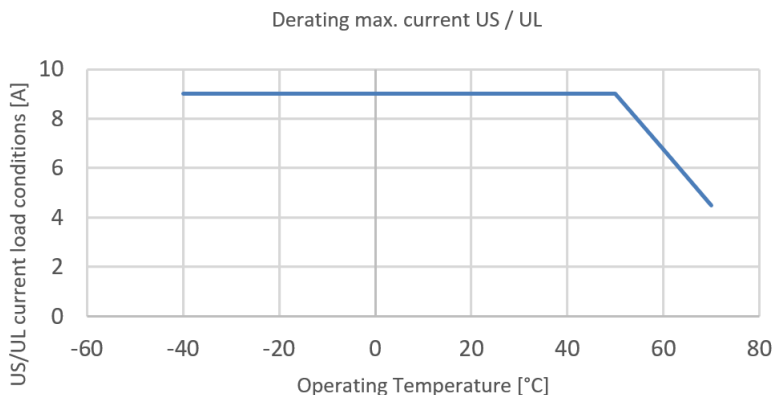

6.3 Port assignments

All the contact arrangements shown in this chapter show the frontal view of the connection area for the connectors.

6.3.1 Ethernet ports, M12 socket, 4-pin, D-coded

Color coding: green

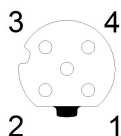

Figure 3: Schematic drawing, ports X01, X02

Port	Pin	Signal	Function
Ethernet Ports X01, X02	1	TD+	Transmit data plus
	2	RD+	Receive data plus
	3	TD-	Transmit data minus
	4	RD-	Receive data minus

Table 6: Assignment of ports X01, X02



Caution: Risk of destruction! Never connect the power supply to the data cables.

6.3.2 Power supply with M12 power L-coded

Color coding: gray

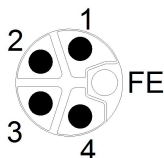

Figure 4: Schematic diagram of the M12 L-coding (connector X03 for Power In)

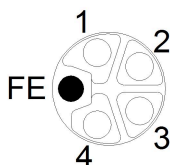

Figure 5: Schematic diagram of the M12 L-coding (socket X04 for Power Out)

Power supply	Pin	Signal	Function
	1	U_S (+24 V)	Sensor/system power supply
	2	GND_ U_L	Ground/reference potential U_L
	3	GND_ U_S	Ground/reference potential U_S
	4	U_L (+24 V)	Actuator power supply
	5	FE	Functional ground

Table 7: Power supply with M12 L-coding



Attention: Only use power supply units for the system/sensor and actuator supply that correspond to PELV (Protective Extra Low Voltage) or SELV (Safety Extra Low Voltage). Power supplies according to EN 61558-2-6 (transformers) or EN 60950-1 (switching power supply units) fulfill these requirements.

6.3.3 I/O ports as M12 sockets

Color	Port
Black	Non-Functional Safety ports
Yellow	Functional Safety ports

Table 8: Color coding I/O ports M12

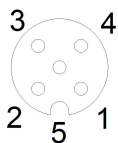

Figure 6: Schematic drawing I/O port as M12 socket IO-Link

0980 XSL 3031-121...	Pin	Signal	Function
FS DI ports X1 ... X4	1	+24 V T-A	Sensor power supply +24 V (A)
	2	IN-B	Ch. B: Digital input
	3	GND U _S	Ground/reference potential U _S
	4	IN-A	Ch. A: Digital input
	5	+24 V T-B	Sensor power supply +24 V (B)
FS DO ports X5 ... X6	1	GND U _L T-A	Reference potential U _L with test function (A)
	2	OUT-B	Ch. B: Digital output
	3	GND U _L	Ground/reference potential U _L
	4	OUT-A	Ch. A: Digital output
	5	GND U _L T-B	Reference potential U _L with test function (B)
IO-Link Class A ports X7 ... X8	1	+24 V	Sensor power supply +24 V
	2	IN/OUT	Ch. B: Digital input or digital output
	3	GND U _S	Ground/reference potential U _S
	4	C/Q IN/OUT	Ch. A: IO-Link data communication, digital input or digital output
	5	n.c.	not connected
0980 XSL 3030-121...	Pin	Signal	Function
FS DI ports X1 ... X8	1	+24 V T-A	Sensor power supply +24 V (A)
	2	IN-B	Ch. B: Digital input
	3	GND U _S	Ground/reference potential U _S
	4	IN-A	Ch. A: Digital input
	5	+24 V T-B	Sensor power supply +24 V (B)

Table 9: I/O port assignment

7 Starting operation

7.1 GSDML file

A GSD file in XML format is required to configure the LioN-Safety variants. All device variants are grouped in a single GSDML file. The file can be downloaded from the product pages on our online catalog: catalog.belden.com

On request, the GSDML file is also sent by the support team.

The GSDML file and the associated bitmap files are grouped together in an archive file named **GSDML-V2.44-BeldenDeutschland-LioN-Safety-20240314.xml**.

yyyymmdd stands for the date on which the file was issued.

Download this file and unpack it.

In Siemens TIA Portal® you create a new project and open the hardware manager under **Configure a device**. Under the menu command **Options > Manage general station description files (GSD)** the GSD file is installed by defining the file path.

The LioN-Safety variants are then available in the hardware catalog.

7.2 MAC addresses

Every device has three unique assigned MAC addresses that cannot be changed by the user. The first assigned MAC address is printed onto the device.

7.3 State on delivery

PROFINET/PROFIsafe parameters in state on delivery or after a factory reset:

PROFINET/PROFIsafe name:	Name not assigned
IP address:	0.0.0.0
Subnet mask:	0.0.0.0
Device designations:	0980 SSL 3031-121-007D-101 0980 SSL 3030-121-007D-101
Vendor ID:	0x016a
Device ID:	0x0401

7.4 Setting the rotary encoding switches

With the rotary encoding switches (x100 / x10 / x1), the destination address of the safety device can be set. After changing the switches, a power cycle is necessary for taking over the new settings.

Additionally, the destination address must be set in the fPar settings during the GSDML configuration.

For a proper configuration, set both settings to the same values.

Protocol	x100	x10	x1
PROFIsafe	0-9	0-9	0-9

Table 10: Assignment of the rotary encoding switches for PROFIsafe

In delivery state the rotary encoding switches are set to "0-0-0".

7.5 SNMPv1

The PROFINET IO-Link Master supports SNMP objects required by the PROFINET specification as per protocol standard SNMPv1. These include objects from RFC 1213 MIB-II (System Group and Interfaces Group) and the LLDP MIB.

Passwords:

- ▶ Read Community: public
- ▶ Write Community: private

8 Configuration and operation with SIEMENS TIA Portal®

i **Note:** The displayed examples of SIEMENS TIA Portal® have been made with TIA V17 and the Step 7 Safety Advanced License.

i **Note:** Each of the displayed configuration and parameterization examples is created with module 0980-SSL-3031-121-007D. Module 0980-SSL-3031-121-007D has a subset of features and differs in the number of configured digital input ports.

After installing the GSDML files for the LioN-Safety variants, they are available in the hardware catalog under **Other field devices > PROFINET IO > IO > Belden Deutschland GmbH > Lumberg Automation LioN-Safety**.

1. First, configure the TIA Portal® project and the control system in the usual way. Assign an IP address and subnet mask for the PROFINET port of the control unit.
2. Then choose the desired device from the Hardware catalog:

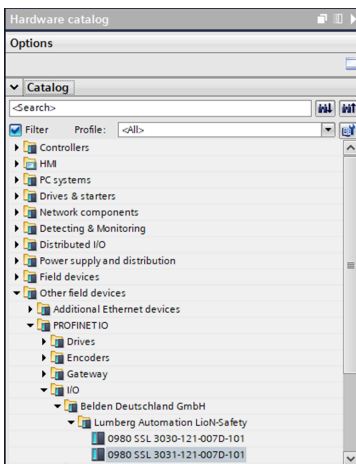

Figure 7: TIA Portal® Hardware catalog

3. Click on the article designations of the modules in the hardware catalog and drag and drop the desired device into the network view:

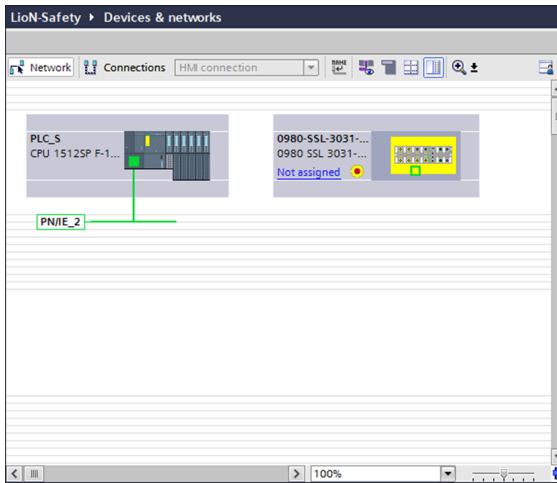

Figure 8: Network view

4. Assign the device to the PROFINET network:

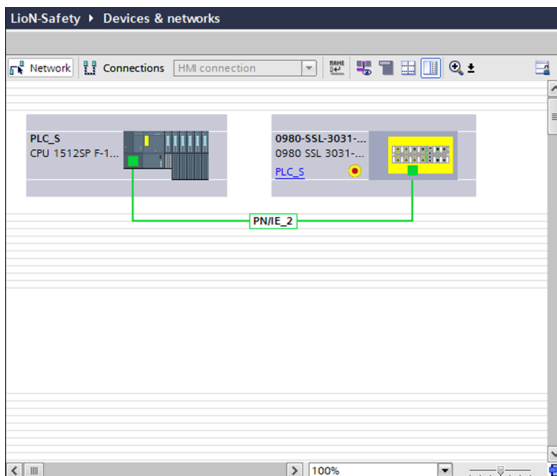

Figure 9: Assign device

- Switch to the device configuration view and select the device to display configuration options:

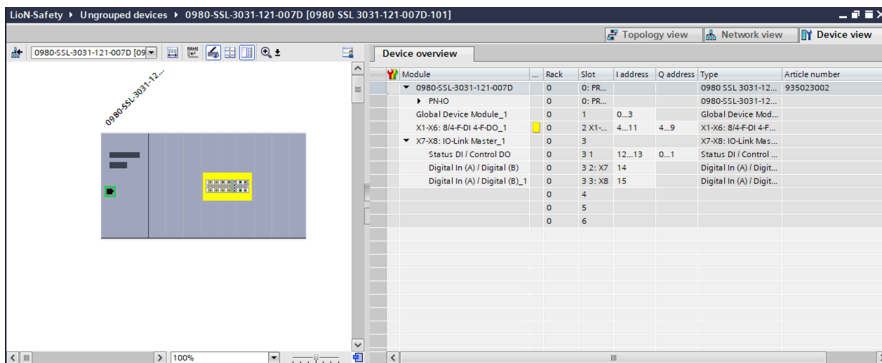

Figure 10: Device configuration

8.1 Assigning a device name and IP address

PROFINET IO devices are addressed on PROFINET via a unique device name. This can be freely assigned by the user but may only be used once on the network.

- A click on the device icon or on the first line of the **Device overview** opens the settings for **PROFINET interface > Ethernet addresses**:

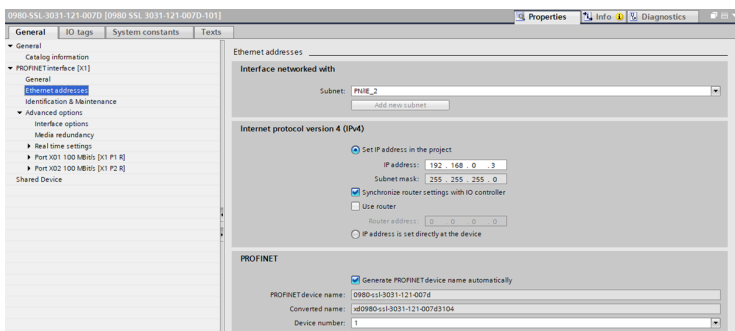

Figure 11: ETHERNET addresses

2. Check that the control unit and the I/O device are on the same Ethernet Subnet.
3. Accept the default settings for IP address and device name or change them if desired.
4. For a correctly working setup, the chosen device name must be programmed online in the I/O device. When the HW is already installed, you can easily change to online mode. The new I/O device should already be accessible via PROFINET:

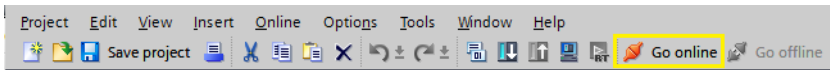

Figure 12: Go online

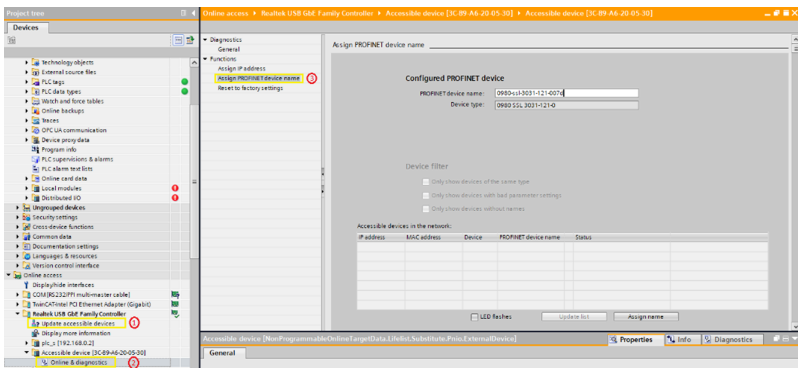

Figure 13: Online mode

5. Enter the same device name as configured in the offline project:

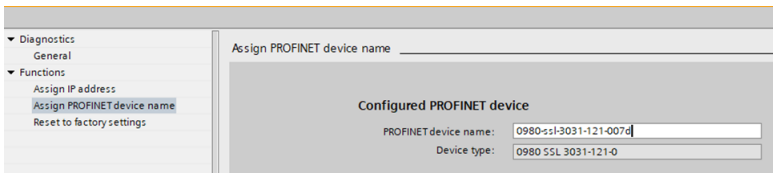

Figure 14: Assign device name

8.2 Configuring LioN-Safety devices

8.2.1 Module 0980 SSL-3030-121-007D

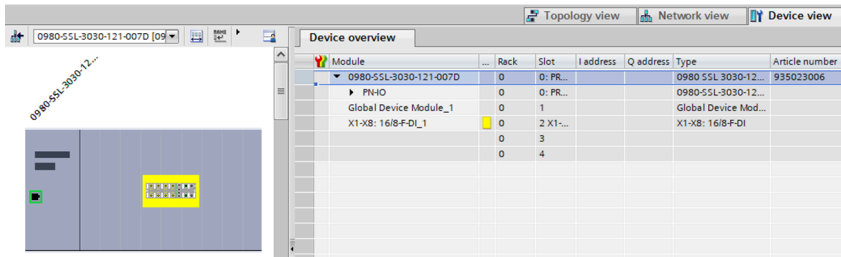

Figure 15: Slot pre-configuration of 0980 SSL 3030-121-007D

Slots 1 and 2 are fixed. Slots 3 and 4 can be used for optionally mirrored modules, e.g. when you wish to mirror the input status and the diagnostics of slots 1 and 2 to a second non-safety PLC via the *Shared Device* function.

Global Device Module (Slot 1):

- ▶ Input data of 16/8-F-DI module for DI parameterized in non-safe mode
- ▶ Slot for global module diagnostics, e.g. "U_s undervoltage"
- ▶ Slot for global module parameters, e.g. "enable/disable Web Interface"

X1 .. X8: 16/8-F-DI (Slot 2):

- ▶ Input data in functional safety mode
- ▶ Slot for functional safety related diagnostics, e.g. "Timeout"
- ▶ Slot for functional safety related parameter settings, e.g. "iPar" and "fPar"

(iPar = application related parameter of the functional safety I/O module;
fPar = PROFIsafe related parameter)



8.2.2 Module 0980 SSL-3031-121-007D

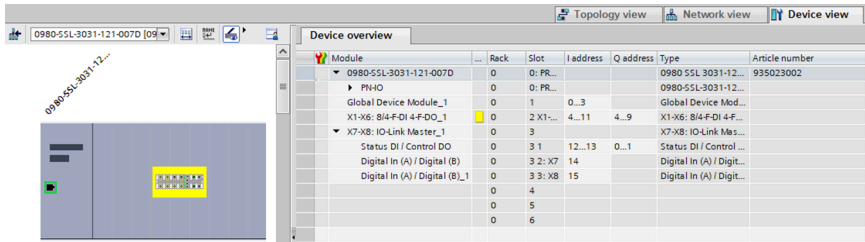



Figure 16: Slot pre-configuration of 0980 SSL 3031-121-007D

Slots 1, 2 and 3 are fixed. Slots 4, 5 and 6 can be used for optionally mirrored modules, e.g. when you wish to mirror the input status and the diagnostics of slots 1 .. 3 to a second non-safety PLC via the *Shared Device* function.

Global Device Module (Slot 1):

- ▶ Input data of 8/4-F-DI 4-F-DO module for DI parameterized in non-safe mode
- ▶ Slot for global module diagnostics, e.g. "U_s undervoltage"
- ▶ Slot for global module parameters, e.g. "enable/disable Web Interface"

X1 .. X6: 8/4-F-DI 4-F-DO (Slot 2) 

- ▶ Input data in functional safety mode (X1 .. X4)
- ▶ Output data in functional safety mode (X5 .. X6)
- ▶ Slot for functional safety related diagnostics, e.g. "Timeout"
- ▶ Slot for functional safety related parameter settings, e.g. "iPar" and "fPar"

(iPar = application related parameter of the functional safety I/O module;
fPar = PROFIsafe related parameter)

X7 .. X8: 8/4-F-DI 4-F-DO (Slot 3):

- ▶ Sub-slot 1: Digital input and output data of slot 3 / sub-slots 2 .. 3, depending on the parametrized I/O mode.
- ▶ Sub-slots 2-3: Input and output data of slot 3 / sub-slots 2 .. 3, depending on the parametrized I/O mode.

Sub-slots 1 .. 3 are also providing parameter settings for the IO-Link Master module and for sub-slot related diagnostics (e.g. IO-Link Device events on the sub-slots 2 and 3).

The configurations of the IO-Link channels (C/Q or Ch. A/Pin 4 of the I/O port) in the sub-slots 2 .. 3 (port X7 of the device is equivalent to sub-slot 2, .. , port X8 of the device is equivalent to sub-slot 3) are flexibly definable.

The input and output addresses defined in the *Device overview* can be changed.

8.2.3 Deleting the configuration of a specified IO-Link channel

1. To delete an IO-Link channel, select the desired IO-Link channel(s) in *Device overview*:

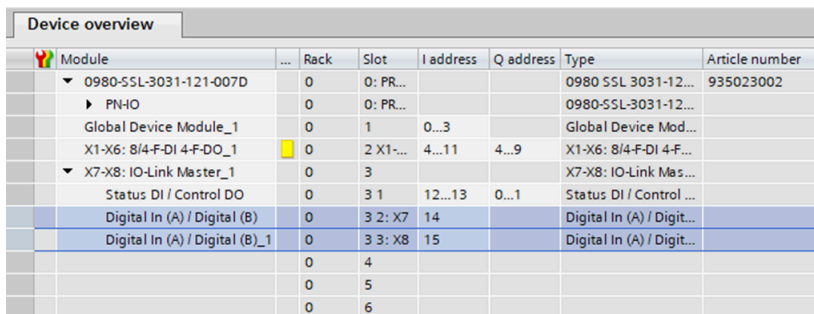

Module	Rack	Slot	I address	Q address	Type	Article number
0980-55L-3031-121-007D	0	0: PR...			0980 55L 3031-12...	935023002
▶ PN-IO	0	0: PR...			0980-55L-3031-12...	
Global Device Module_1	0	1	0...3		Global Device Mod...	
X1-X6: 8/4-F-DI 4-F-DO_1	0	2 X1-...	4...11	4...9	X1-X6: 8/4-F-DI 4-F...	
X7-X8: IO-Link Master_1	0	3			X7-X8: IO-Link Mas...	
Status DI / Control DO	0	3 1	12...13	0...1	Status DI / Control ...	
Digital In (A) / Digital (B)	0	3 2: X7	14		Digital In (A) / Digit...	
Digital In (A) / Digital (B)_1	0	3 3: X8	15		Digital In (A) / Digit...	
	0	4				
	0	5				
	0	6				

Figure 17: Device overview

2. Right click and then select the *Delete* option in the appearing menu:

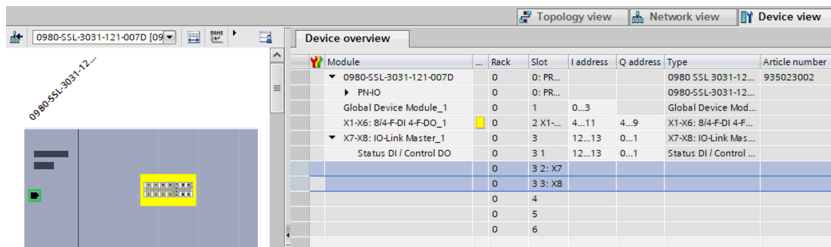

Module	Rack	Slot	I address	Q address	Type	Article number
0980-55L-3031-121-007D	0	0: PR...			0980 55L 3031-12...	935023002
▶ PN-IO	0	0: PR...			0980-55L-3031-12...	
Global Device Module_1	0	1	0...3		Global Device Mod...	
X1-X6: 8/4-F-DI 4-F-DO_1	0	2 X1-...	4...11	4...9	X1-X6: 8/4-F-DI 4-F...	
X7-X8: IO-Link Master_1	0	3	12...13	0...1	X7-X8: IO-Link Mas...	
Status DI / Control DO	0	3 1	12...13	0...1	Status DI / Control ...	
	0	3 2: X7				
	0	3 3: X8				
	0	4				
	0	5				
	0	6				

Figure 18: Free IO-Link channel(s)



8.2.4 Creating an IO-Link channel configuration

The *Submodules* folder of the I/O device inside the *Hardware catalog* shows all configurable options that can be selected:

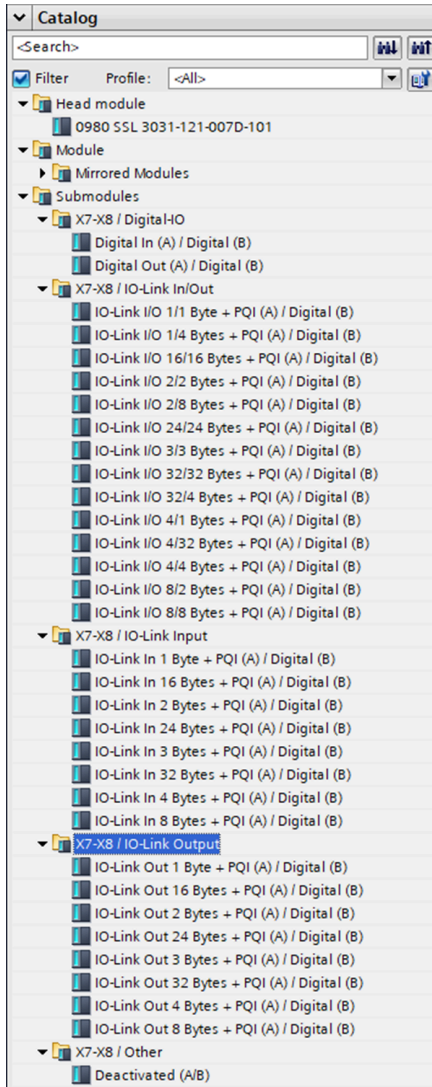

Figure 19: IO-Link channel configuration



Select the desired option, click and hold down the left mouse button to drag the configuration to a free IO-Link sub-slot:

Device overview						
Module	Rack	Slot	I address	Q address	Type	Article number
0980-SSL-3031-121-007D	0	0: PR...			0980-SSL-3031-12...	935023002
PNHO	0	0: PR...			0980-SSL-3031-12...	
Global Device Module_1	0	1	0...3		Global Device Mod...	
X1-X6: 8/4-F-DI 4-F-DO_1	0	2 X1...	4...11	4...9	X1-X6: 8/4-F-DI 4-F...	
X7-X8: IO-Link Master_1	0	3			X7-X8: IO-Link Mas...	
Status DI / Control DO	0	3 1	12...13	0...1	Status DI / Control ...	
Digital Out (A) / Digital (B)	0	3 2: X7		2	Digital Out (A) / Dig...	
IO-Link I/O 4/4 Bytes + P...	0	3 3: X8	14...18	10...13	IO-Link I/O 4/4 Byte...	
	0	4				
	0	5				
	0	6				

The following options are available for the IO-Link C/Q channel (Ch. A/Pin 4):

Digital In (DI)

In this mode the channel operates as a digital input.

Digital Out (DO)

In this mode, the channel operates as a digital output.

Deactivated

This mode should be selected if the A-channels and the B-channels of the I/O ports (ports X7 .. X8) are not used. The L+ power supply (pin 1) of the port is disabled in this case.

IO-Link ...

In this mode (IO-Link communication mode), the process data from or to the device are exchanged over a communication link. Depending on the port configuration, the IO-Link Master automatically starts communicating with the connected IO-Link Device, taking into account the baud rate. Additionally, this mode offers the option of parameterizing the IO-Link Device. Configuration modules with data lengths of 1 .. 33 bytes for physical inputs and 1 .. 32 bytes for physical outputs are available. If no suitable configuration module is available for the device, the next larger data length must be selected. After the first configuration of the device, this port configuration will be stored non-volatile on the IO-Link Master. This means that with the next power-up the



I/O port will be pre-configured with these settings before the controller will send a new port configuration. The sensor supply (I/O port Pin 1) and the auxiliary supply (I/O port Pin 2) will be powered up directly depending on the last active configuration. A configuration telegram of the PN-Controller is not being required. The I/O data remain invalid until a new configuration is received after the power-up of the IO-Link Master.

8.3 Parameterization of the Global Device Module

Device overview								
Module	Rack	Slot	I address	Q address	Type	Article number		
0980-SSL-3031-121-007D	0	0: PR...			0980 SSL 3031-12...	935023002		
PN-IO	0	0: PR...			0980-SSL-3031-12...			
Global Device Module_1	0	1	0...3		Global Device Mod...			
X1-X6: 8/4-F-DI 4-F-DO_1	0	2 X1...	4...11	4...9	X1-X6: 8/4-F-DI 4-F...			
X7-X8: IO-Link Master_1	0	3			X7-X8: IO-Link Mas...			
Status DI / Control DO	0	3 1	12...13	0...1	Status DI / Control ...			
Digital Out (A) / Digital (B)	0	3 2: X7		2	Digital Out (A) / Dig...			
IO-Link I/O 4/4 Bytes + P...	0	3 3: X8	14...18	10...13	IO-Link I/O 4/4 Byte...			
	0	4						
	0	5						
	0	6						

Figure 20: Global Device Module

Module parameters
General Device Settings
IO Mapping Configuration of DI in Non Safe Mode (X1-X4)
General Diagnostic Settings
Module failure

Figure 21: Parameters Global Device Module

The Global Device Module in slot 1 is pre-configured for each LioN-Safety module. It consists of 4 bytes of input data for the digital inputs in non-safe mode. The bit assignments are described in section [Process data assignment](#) on page 143.

The following parameterizations are possible after clicking on the sub-items under the *Module parameters*.

8.3.1 General Device Settings

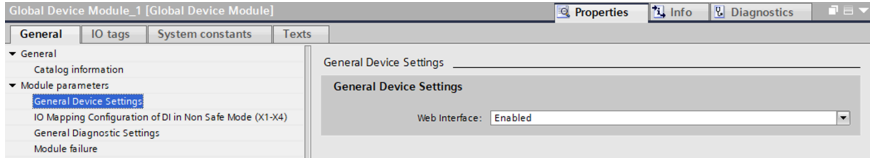

Web Interface

The Web interface access can be set to "Enabled" or "Disabled" with this parameter. In case of the "Disabled" setting, the Web pages are not reachable.

Default: Enabled

8.3.2 I/O mapping configuration

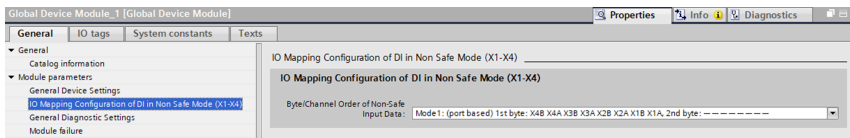

Byte/Channel order of Global Device Input data

With this parameter, 2 pre-defined bit mappings (Mode 1 .. 2) for the digital input bits can be selected. The digital input data will be mapped to the Global Device Module's inputs when the respective functional safety input ports are configured to non-safe mode.

Key

1st byte = low address byte in a Siemens PLC

2nd byte = high address byte in a Siemens PLC

(applicable for a Siemens PLC using Big-Endian format)

Mode 1 (default):

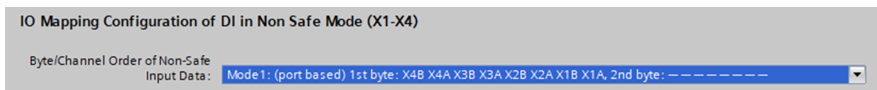

Mode 2:

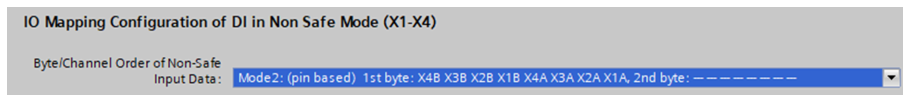

For detailed I/O mapping refer to chapter [Process data Global Device Module](#) on page 143.

8.3.3 General diagnostic settings

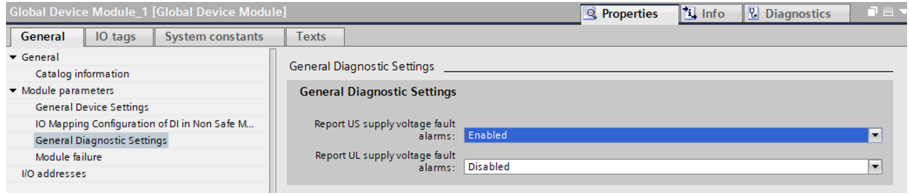

Report U_S supply voltage fault alarms

The U_S supply voltage fault alarm can be set to "Disabled" or "Enabled" with this parameter.

Default: Enabled

Report U_L supply voltage fault alarms

The U_L supply voltage fault alarm can be set to "Disabled", "Enabled" or "Auto Mode" with this parameter.

In "Auto Mode", the U_L diagnosis will be activated with the first rising slope detection after power-up.

Default: Disabled



Attention: "Report U_L supply voltage fault" is disabled in the default setting to avoid diagnostic messages due to switching the supply voltage on or off later on.

8.4 Parameterization of the Safety I/O module

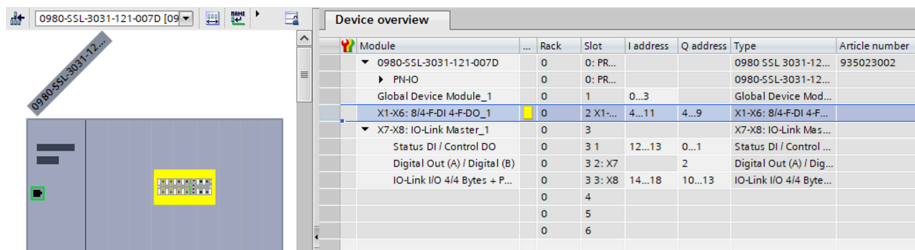

Module	Rack	Slot	I address	Q address	Type	Article number
0980-55L-3031-121-007D	0	0: PR...			0980 55L 3031-12...	935023002
PN-IO	0	0: PR...			0980-55L-3031-12...	
Global Device Module_1	0	1	0...3		Global Device Mod...	
X1-X6: 8/4-F-DI 4-F-DO_1	0	2 X1...	4...11	4...9	X1-X6: 8/4-F-DI 4-F...	
X7-X8: IO-Link Master_1	0	3			X7-X8: IO-Link Mes...	
Status DI / Control DO	0	3:1	12...13	0...1	Status DI / Control ...	
Digital Out (A) / Digital (B)	0	3:2: X7		2	Digital Out (A) / Dig...	
IO-Link I/O 4/4 Bytes + P...	0	3:3: X8	14...18	10...13	IO-Link I/O 4/4 Byte...	
	0	4				
	0	5				
	0	6				

The external wiring of the digital inputs must be considered from a safety point of view in order to meet the requirements for the safety functions.

8.4.1 Module parameters

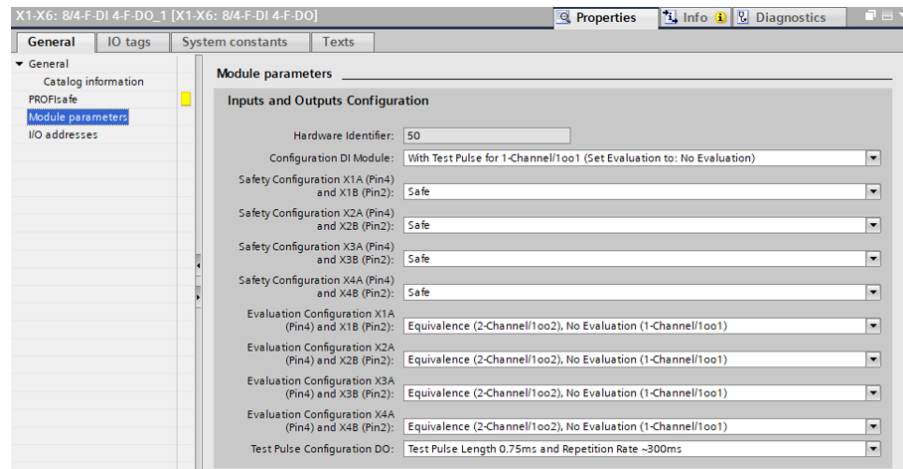

Module parameters

Inputs and Outputs Configuration

Hardware Identifier: 50

Configuration DI Module: With Test Pulse for 1-Channel/1oo1 (Get Evaluation to: No Evaluation)

Safety Configuration X1A (Pin4) and X1B (Pin2): Safe

Safety Configuration X2A (Pin4) and X2B (Pin2): Safe

Safety Configuration X3A (Pin4) and X3B (Pin2): Safe

Safety Configuration X4A (Pin4) and X4B (Pin2): Safe

Evaluation Configuration X1A (Pin4) and X1B (Pin2): Equivalence (2-Channel/1oo2), No Evaluation (1-Channel/1oo1)

Evaluation Configuration X2A (Pin4) and X2B (Pin2): Equivalence (2-Channel/1oo2), No Evaluation (1-Channel/1oo1)

Evaluation Configuration X3A (Pin4) and X3B (Pin2): Equivalence (2-Channel/1oo2), No Evaluation (1-Channel/1oo1)

Evaluation Configuration X4A (Pin4) and X4B (Pin2): Equivalence (2-Channel/1oo2), No Evaluation (1-Channel/1oo1)

Test Pulse Configuration DO: Test Pulse Length 0.75ms and Repetition Rate ~300ms

Configuration F-DI module

- ▶ Option 1: Without Test Pulse for 1-Channel Mode/1oo1

Configuration DI Module: Without Test Pulse for 1-Channel/1oo1 (Set Evaluation to: No Evaluation) 

In this mode, the Pin1 and Pin5 sensor supplies of a digital input port will **not be switched off** for functional hardware tests.

Both input channels A and B can be used independently.

For detailed information, see [Functional Safety I/O modes](#) on page 162.



Attention: When you choose Option 1, the *Evaluation Configuration* must be set to 'No Evaluation (1-Channel/1oo1)':

Equivalence (2-Channel/1oo2), No Evaluation (1-Channel/1oo1) 

- ▶ Option 2: With Test Pulse for 1-Channel Mode/1oo1

Configuration DI Module: With Test Pulse for 1-Channel/1oo1 (Set Evaluation to: No Evaluation) 

In this mode, the Pin1 and Pin5 sensor supplies of a digital input port will **be switched off** for cyclical Functional Safety hardware tests.

Both input channels A and B can be used independently.

For detailed information, see [Functional Safety I/O modes](#) on page 162.



Attention: When you choose Option 2, the *Evaluation Configuration* must be set to 'No Evaluation (1-Channel/1oo1)':

Equivalence (2-Channel/1oo2), No Evaluation (1-Channel/1oo1) 

- Option 3A: Without Test Pulse for 2-Channel Mode & Equivalence Evaluation

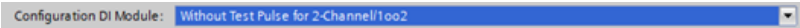

In this mode, the Pin1 and Pin5 sensor supplies of a digital input port are **not switched off** for functional hardware tests.

Both physical input channels A and B will be used for one-bit information of the digital input represented in the channel A bit and mirrored in the channel B bit. Depending on the 'Equivalence' set in *Evaluation Configuration*, both input channels must be equal for a valid input status on the channel A bit.

For detailed information, see [Functional Safety I/O modes](#) on page 162.

- Option 3B: Without Test Pulse for 2-Channel Mode & Antivalence Evaluation

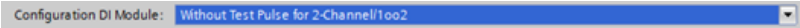

In this mode, the Pin1 and Pin5 sensor supplies of a digital input port are **not switched off** for functional hardware tests.

Both physical input channels A and B will be used for one-bit information of the digital input represented in the channel A bit and mirrored in the channel B bit. Depending on the 'Antivalence' set in *Evaluation Configuration*, both input channels must have the opposite status for a valid input status on the channel A bit.

For detailed information, see [Functional Safety I/O modes](#) on page 162.

► Option 4A: With Test Pulse for 2-Channel Mode & Equivalence Evaluation

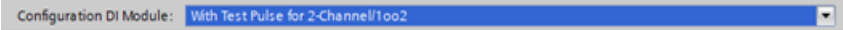

In this mode, the Pin1 and Pin5 sensor supplies of a digital input port will **be switched off** for functional hardware tests.

Both physical input channels A and B will be used for one-bit information of the digital input represented in the channel A bit and mirrored in the channel B bit. Depending on the 'Equivalence' set in *Evaluation Configuration*, both input channels must have the same status for a valid input status on the channel A bit.

For detailed information, see [Functional Safety I/O modes](#) on page 162.

► Option 4B: With Test Pulse for 2-Channel Mode & Antivalence Evaluation



In this mode, the Pin1 and Pin5 sensor supplies of a digital input port will **be switched off** for functional hardware tests.

Both physical input channels A and B will be used for one-bit information of the digital input represented in the channel A bit and mirrored in the channel B bit. Depending on the 'Antivalence' set in *Evaluation Configuration*, both input channels must have the opposite status for a valid input status on the channel A bit.

For detailed information, see [Functional Safety I/O modes](#) on page 162.

Safety Configuration

Safety Configuration X1A (Pin4) and X1B (Pin2):	Safe
Safety Configuration X2A (Pin4) and X2B (Pin2):	Non Safe
Safety Configuration X3A (Pin4) and X3B (Pin2):	Safe
Safety Configuration X4A (Pin4) and X4B (Pin2):	Safe

The input mode can be set to 'Safe' or 'Non-Safe'. In "Non-Safe" mode, the input data are mapped into the *Global Device* input data. This setting is valid for both channels (A/B) of a digital input port.



Attention: For 'Non-Safe' configured ports, the parameters *Configuration DI Module* and *Evaluation Configuration* will not be applied.

Default: Safe

Evaluation Configuration

Evaluation Configuration X1A (Pin4) and X1B (Pin2):	Equivalence (2-Channel/1oo2), No Evaluation (1-Channel/1oo1)
Evaluation Configuration X2A (Pin4) and X2B (Pin2):	Antivalence (2-Channel/1oo2)
Evaluation Configuration X3A (Pin4) and X3B (Pin2):	Equivalence (2-Channel/1oo2), No Evaluation (1-Channel/1oo1)
Evaluation Configuration X4A (Pin4) and X4B (Pin2):	Equivalence (2-Channel/1oo2), No Evaluation (1-Channel/1oo1)

The *Evaluation Configuration* can be set to 'Equivalence/No Evaluation' or to 'Antivalence'. This setting is valid for both channels (A/B) of a digital input port.



Attention: When you choose the option '1-Channel Mode' in the parameter *Configuration DI Module*, the parameter *Evaluation Configuration* must be set to 'Equivalence/No Evaluation':

Equivalence (2-Channel/1oo2), No Evaluation (1-Channel/1oo1)
--

Default: Equivalence/No Evaluation

Test Pulse Configuration F-DO

Digital functional safety outputs will **be switched off** for cyclical Functional Safety hardware tests. With this parameter, the duration and repetition rate will be set. This parameter must be configured with regards to the used actuator to avoid switching of, e.g., a fast-responsive valve.

- ▶ Option 1: Test Pulse Length 0.75ms and Repetition Rate ~300ms

Test Pulse Configuration DO: Test Pulse Length 0.75ms and Repetition Rate ~300ms

- ▶ Option 2: Test Pulse Length 50ms and Repetition Rate ~5s

Test Pulse Configuration DO: Test Pulse Length 50ms and Repetition Rate ~5s

- ▶ Option 3: Test Pulse Length 100ms and Repetition Rate ~10s

Test Pulse Configuration DO: Test Pulse Length 100ms and Repetition Rate ~10s

Default: Test Pulse Length 0.75ms and Repetition Rate ~300ms

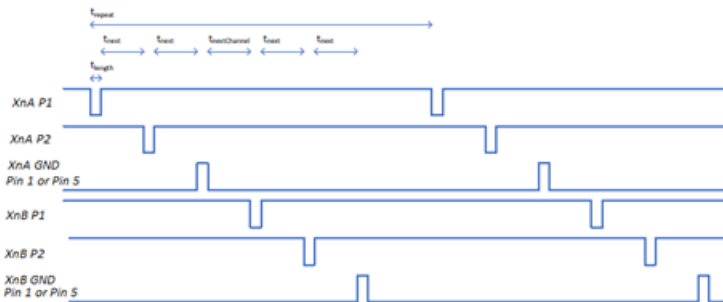

Figure 22: Diagram: F-DO test pulse timing

For failsafe reasons, the two switches P1 and P2 are serially connected with one output channel.

For a test pulse length of 0.75 ms (max.) and a repetition rate of min. 300 ms:

$$t_{\text{length}} = 0.75 \text{ ms}$$

$$t_{\text{next}} = 12 \text{ ms (per output switch P1/P2/GND)}$$

$t_{\text{repeat}} = 336 \text{ ms}$ (related to [Figure 22: Diagram: F-DO test pulse timing](#) on page 63 with P1, P2 and GND switch)

$$t_{\text{nextChannel}} \geq t_{\text{next}}$$

For a test pulse length of 50 ms (max.) and a repetition rate of ~5 ms:

$$t_{\text{length}} = 36 \text{ ms}$$

$$t_{\text{next}} = 12 \text{ ms (per output switch P1/P2/GND)}$$

$$t_{\text{repeat}} = 5 \dots 5.2 \text{ s}$$

For a test pulse length of 100 ms (max.) and a repetition rate of ~10 s:

$$t_{\text{length}} = 60 \text{ ms}$$

$$t_{\text{next}} = 60 \text{ ms (per output switch P1/P2/GND)}$$

$$t_{\text{repeat}} = 10 \dots 10.3 \text{ s}$$

Usable Digital Input settings for failsafe slot 2:

Not all combinations of module parameter settings are usable. In the following table you find an overview of the allowed (✓) settings. Non-usable settings (Ø) will also be rejected by the CRC generator in the "Safety Configurator App" (see [PROFIsafe Configurator App](#) on page 179).

Safe / Non-Safe Mode	Evaluation	Configuration F-DI Module			
		1-Channel/1oo1		2-Channel/1oo2	
		w/o test pulse	w/ test pulse	w/o test pulse	w/ test pulse
Safe only	No	✓	✓	∅	∅
	Equivalence	∅	∅	✓	✓
	Antivalence	∅	∅	✓	✓
Safe & Non-Safe	No	✓	∅	∅	∅
	Equivalence	∅	∅	∅	∅
	Antivalence	∅	∅	∅	∅
Non-Safe only	No	✓	∅	∅	∅
	Equivalence	∅	∅	∅	∅
	Antivalence	∅	∅	∅	∅

8.4.2 PROFIsafe parameters

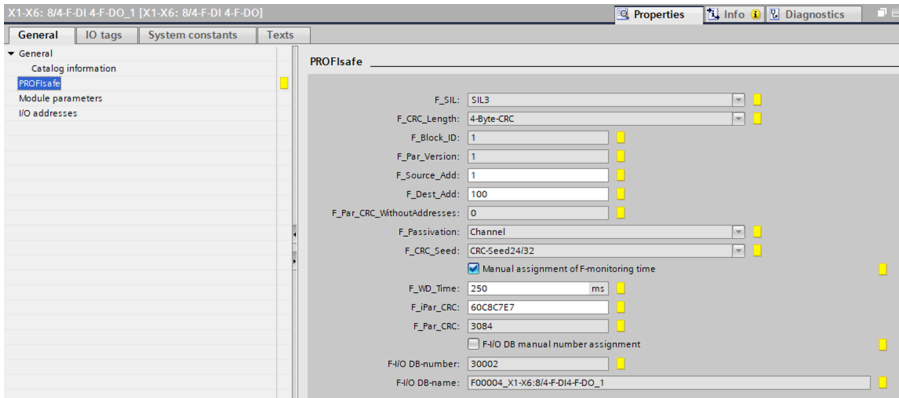

8.4.2.1 F_Source_Add

The F-Source address of the controller. The setting of the controller must be entered in this field.

The Safety I/O module supports PROFsafe addressing type 1. The user is responsible for setting a unique F_Dest_Add (F-Destination Address) within the network. The F-Source address will not be checked by the Safety I/O module.

Default value: 1

8.4.2.2 F_Dest_Add

The F Destination address of the Safety I/O module.

The Safety I/O module supports PROFsafe addressing type 1. The user is responsible for setting a unique F_Dest_Add (F-Destination Address) within the network. The F-Source address will not be checked by the Safety I/O module.

This setting must match the rotary encoding switch settings of the device (X100-X10-X1).

Usable address range of rotary encoding switches: "1 .. 999", without "979" and "999".

Default value: 1

8.4.2.3 F_WD_Time

The F Watchdog Time of the Safety I/O module. This setting defines the delay until the I/O-Device switches into safe state, after the communication between the PROFIsafe Safety controller and the Functional Safety I/O-Device is lost.

Default value: 250 ms

Calculate with communication delays for choosing the right F_WD_Time.



Attention: The selected F_WD_Time impacts the safety function response time (SFRT).

Example for calculating the right value:

Type of delay	Time
I/O device acknowledgment time (DAT) With activated IloT protocols (= 72 ms) or without activated IloT protocols (= 60 ms).	+72 ms or +60 ms
Host acknowledgement time (HAT of F-PLC)	+
PROFINET cycle time (multiplied by 4)	+
F_WD_TIME ≥	

8.4.2.4 F_iPar_CRC

In this field, the F iParameter CRC must be set. The F iParameter CRC will be calculated from the settings of the module parameters (application specific parameters).

Default value: 123456789 = 0x75BCD15 (Dummy)

The following workflow describes the setting of the F iParameter CRC:

1. Install the Belden Safety Configurator (download from <https://www.belden.com>).
2. Set the module parameters.

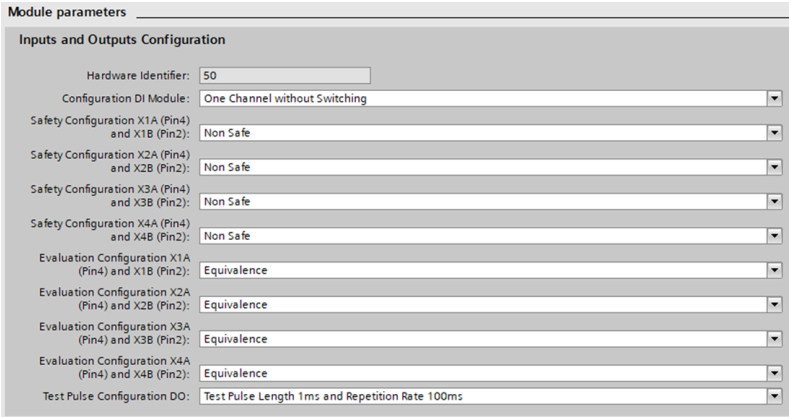

3. Start the Belden Safety Configurator by clicking with the right mouse button on the Safety Device symbol or on 'Slot 2'. Choose 'Start Device Module'.

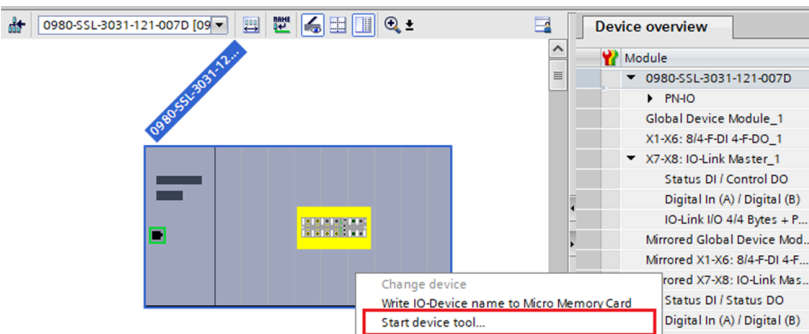

4. Select the Device Description File as used in the TIA Portal® project.
5. Make sure that all parameters are displayed accordingly to the settings in the TIA Portal® project. Activate the checkbox 'I have checked all parameter entries' and click on the button *Calculate iPar_CRC*.

6. Copy the calculated iPar_CRC value into the clipboard.
7. Navigate back to the TIA Portal® project and go to the F_iPar_CRC field on page *Module parameters* of the respecting Safety device. Enter the iPar_CRC (from the clipboard) into the field and press *Enter*. This causes an update of the below F_Par_CRC. The F_Par_CRC will be generated over the PROFIsafe parameter which includes the iPar_CRC. With the F_iPar_CRC and the F_Par_CRC, the PROFIsafe I/O-Device can check the validity of the received parameters.

8.5 Parameterization of the Status/Control Module

Device overview							
Module	Rack	Slot	I address	Q address	Type	Article number	
0980-55L-3031-121-007D	0	0: PR...			0980 55L 3031-12...	935023002	
▶ PNHO	0	0: PR...			0980-55L-3031-12...		
Global Device Module_1	0	1	0...3		Global Device Mod...		
X1-X6: 8/4-F-DI 4-F-DO_1	0	2 X1-...	4...11	4...9	X1-X6: 8/4-F-DI 4-F...		
X7-X8: IO-Link Master_1	0	3			X7-X8: IO-Link Mas...		
Status DI / Control DO	0	3 1	12...13	0...1	Status DI / Control ...		
Digital Out (A) / Digital (B)	0	3 2: X7		2	Digital Out (A) / Dig...		
IO-Link I/O 4/4 Bytes + P...	0	3 3: X8	14...18	10...13	IO-Link I/O 4/4 Byte...		
	0	4					
	0	5					
	0	6					

Figure 23: Status/Control Module

Parameters within the Status/Control Module:

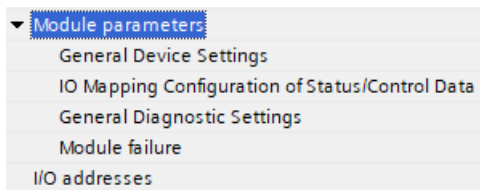

Figure 24: Parameters Status/Control Module

The Status/Control Module in slot 3 / sub-slot 1 is pre-configured for each LioN-Safety IOL-Master. It consists of 2 bytes of input and 2 bytes of output data for the digital I/O data. The bit assignments are described in Section [Process data assignment](#) on page 143.

The Status/Control Module can also be used to perform some general parameterizations that do not affect any functionality of channels in IO-Link mode.

The following parameterizations are possible after clicking on the subitems under the *Module parameters*.

8.5.1 General Device Settings

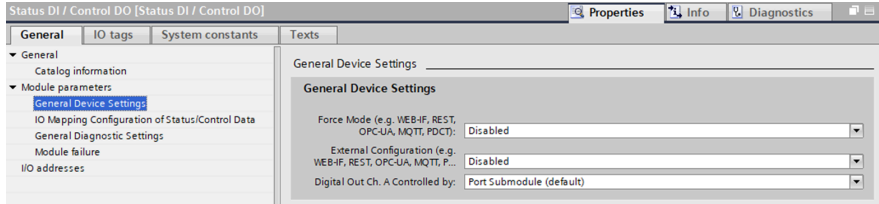

Force Mode

The input and output I/O data of this slot 3 can be forced (= changed) for implementation reasons. This can be done by different interfaces (e.g. Web interface, REST, OPC UA, MQTT). The support of interfaces for Forcing depends on the chosen software variant. With this function the possibility of forcing I/O data can be enabled or disabled.

Default: Disabled



Danger: Risk of physical injury or death! Unattended forcing can lead to unexpected signals and uncontrolled machine movements.

External Configuration

Configuration and parameter data can be set over different external interfaces outside the GSDML configuration (e.g. Web interface, REST, OPC UA, MQTT). With this option, the “External Configuration” can be enabled or disabled. An external configuration can only be done, if no cyclic PLC connection is active. Every new PLC overwrites the external configuration settings.

Default: Disabled

Digital Out Ch. A controlled by...

► Port Sub-module:

For controlling the digital A channels, the output **Byte 1 / Bit 0** of the appropriate sub-slot module must be used.

► Status/Control Module:

In this case, the digital A channel outputs can be controlled by the Status/Control Module output bits. The digital output can be controlled only by one data source.

Default: Port Sub-module

8.5.2 I/O mapping configuration of Status/Control data

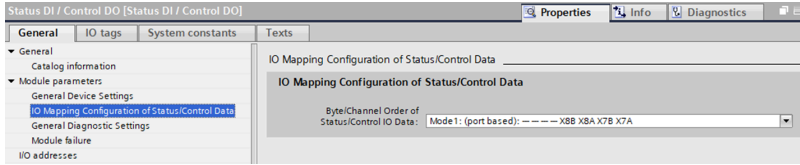

Byte/Channel order of Status/Control I/O data

With this parameter, 2 (Mode 1 .. 2) pre-defined bit mappings for the digital I/O bits can be selected. The I/O data will be mapped to the Status/Control Module's input and output bytes.

The chosen mapping will be used in the same way for the input and output data direction.

Mode 1:

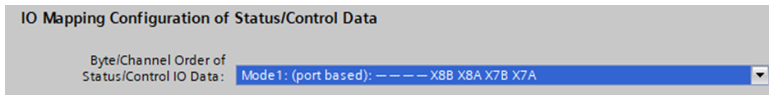

Mode 2:

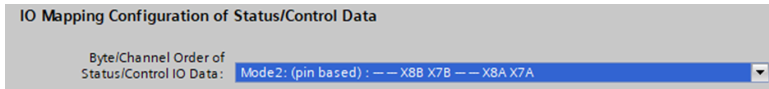

The second byte in the input direction represents the qualifier (valid) information for each digital input of ports X7 and X8 in the same mapping order as the input status in the first byte.

For detailed I/O mapping refer to chapter [Process data Status DI/Control DO](#) on page 151.

8.5.3 General Diagnostic Settings

Voltage information U_L / U_S

- ▶ U_L (Load voltage) is used for the functional safety outputs' supply. Only the functional safety outputs are supplied by U_L . U_L is electrically isolated to U_S . Keep this in mind when using different device types supplied by U_L in the same chain application.
- ▶ U_S (Sensor/System voltage) is used for non-safe output supply.

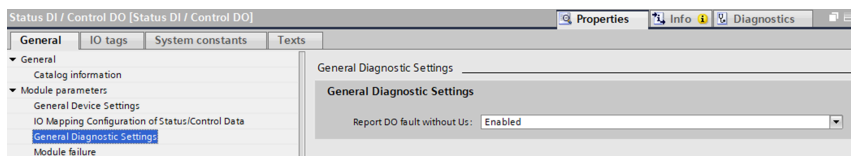

Report DO fault without U_S

The diagnosis of digital outputs can be configured in dependency of the U_S status.

When the output will be activated without a valid U_S range, while this parameter is set to "Enabled", a diagnosis message will be generated for the output channel.

Default: Enabled

8.6 Parameterization of the I/O ports X7 .. X8

In the device configuration mode, click on the corresponding IO-Link sub-slot in the *Device overview* and select the option *module parameters* for setting the following parameters:

Device overview

Module	Rack	Slot	I address	Q address	Type	Article number
0980-5SL-3031-121-007D	0	0: PR...			0980 5SL 3031-12...	935023002
▶ PN-IO	0	0: PR...			0980-5SL-3031-12...	
Global Device Module_1	0	1	0...3		Global Device Mod...	
X1-X6: 8/4-F-DI 4-F-DO_1	0	2 X1...	4...11	4...9	X1-X6: 8/4-F-DI 4-F...	
X7-X8: IO-Link Master_1	0	3			X7-X8: IO-Link Mas...	
Status DI / Control DO	0	3 1	12...13	0...1	Status DI / Control ...	
Digital Out (A) / Digital (B)	0	3 2: X7		2	Digital Out (A) / Dig...	
IO-Link I/O 4/4 Bytes + P...	0	3 3: X8	14...18	10...13	IO-Link I/O 4/4 Byte...	
	0	4				
	0	5				
	0	6				

IO-Link I/O 4/4 Bytes + PQI (A) / Digital (B) IO-Link I/O 4/4 Bytes + PQI (A) / Digital (B)

Properties Info Diagnostics

General IO tags System constants Texts

General
Catalog information
Hardware interrupts
Module parameters
IO addresses

Module parameters

Enhanced Port Parameters

Sensor Supply Mode Pin 1(L+): Active

DI Filter, Ch. B: 3ms

DI Logic, Ch. B: Normally Open (NO)

DO Restart Mode, Ch. B: Restart after Output Reset

DO Fault Alarm, Ch. B: Enabled

DO Switch Mode, Ch. B: High-Side Switch (Pwr supply by Us): 2.0A Max.

DO Failsafe Value, Ch. B: Set Low

DO Surveillance Timeout, (in milliseconds), Ch. B: 80

IOL In-Data Swapping Mode, Ch. A: Off

IOL In-Data Swapping Type, Ch. A: Word

IOL In-Data Swapping Offset, (Bytes) Ch. A: 0

IOL Out-Data Swapping Mode, Ch. A: Off

IOL Out-Data Swapping Type, Ch. A: Word

IOL Out-Data Swapping Offset, (Bytes) Ch. A: 0

Failsafe Port Parameters for Ch. A in IO-Link Mode

Failsafe Value(s): Set Low

Replacement Value (Byte 1, enter in decimal): 0

Replacement Value: 0

Replacement Value: 0

Replacement Value (Byte n, enter in decimal): 0

Standardized Port Parameters

Digital Mode, Ch. B (IQ): Digital Input

Port Diagnostics, L+ / Ch. A (CQ) / Ch. B (CQ) / Device errors and ...: Enabled

Process Alarms (notifications), Ch. A (COM): Enabled

Configuration Source: PROFNETIO Controller

Input Fraction, Ch. A (COM): Disabled

Pull/Plug Alarms, Ch. A (COM): Enabled

Port Mode Ch. A (COM): IO-Link - autostart (below options excluded)

Validation and Backup, Ch. A (COM): No device check

Port Cycle Time, Ch. A (COM): As fast as possible

Vendor ID, Ch. A (COM): 0

Device ID, Ch. A (COM): 0

Figure 25: Parameters of the IO-Link channels

8.6.1 Enhanced port parameters

In dependency of the configured sub-module, some of the following described parameters can differ.

(Available only for special channel, otherwise not available.)

Sensor Supply Mode Pin 1 / L+

The sensor supply on pin 1 is always active and cannot be disabled.

DI Filter

With this parameter, the filter time of the digital input can be defined. The following options are available:

Off; 1 ms; 2 ms; 3 ms; 6 ms; 10 ms; 15 ms

Default: 3 ms

DI Logic

This parameter can be used to configure the logic of the channels used as digital inputs.

► NO (Normally Open):

A non-damped sensor has an open switching output (low signal) in this case. The device input detects a low signal and returns a "0" to the control unit.

The LED of the channel shows the physical input state.

► NC (Normally Closed):

A non-damped sensor has a closed switching output (high signal) in this case. The device input detects a high signal, inverts the signal, and returns a "0" to the control unit.

The channel LED displays, independent of the setting, the physical input state.

Default: NO (Normally Open) for all channels

DO Restart Mode

With this parameter, the digital output restart behavior can be set.

► Automatic Restart after Failure:

In case of detecting an output short circuit or overload, the output will be switched off by the IO-Link Master. However, after a time delay, the output will automatically be turned on again for checking if the overload or short circuit condition is active.

► Restart after Output Reset:

In case of detecting an output short circuit or overload, the output will be switched off by the IO-Link Master.

The output will not be set automatically. Before the output can be turned on again, it must be logically reset by the PLC.

Default: Automatic Restart after Failure

DO Switch Mode

With this option, the mode of the digital output switch can be selected.

► Push Pull Switch (0.5 A):

In this mode, the output will be switched active to high and low. In low state, the output can be a current sink. In this mode, the digital output will be supplied by U_S .

► High-Side Switch (0.5 A; 1.0 A; 1.5 A; 2,0 A; 2.0 A Max.):

In this mode, the output will be switched active to high, but not to low. Output low means high impedance at digital output. Additionally, the current limitation can be selected for each digital output in High-Side Switch mode. This means that the level for actuator overload diagnostic can be managed by this selection. *2.0 A Max.* means, that current limitation is **not** active and the maximum output current for this output is available..

Refer to chapter [I/O port overview](#) for the voltage supply of the digital outputs.

Default: High-Side Switch (2.0 A Max.)

DO Failsafe Value

The device supports a failsafe function for the channels used as digital outputs. During configuration of the devices, the status of the PROFINET IO device outputs can be defined after an interruption, or loss of communication on the PROFINET IO network.

The following options can be selected:

- ▶ Set Low - the output channel is disabled and/or the output bit set to "0".
- ▶ Set High - the output channel is enabled and/or the output bit set to "1".
- ▶ Hold last – the last output state is kept.

Default: Set Low

DO Surveillance Timeout

For channels configured as digital output, the firmware of the modules allows you, for this special use case, to set a delay time before output status monitoring is enabled.

The delay time is referred to as the "Surveillance-Timeout" and can be configured for each output channel. The delay time begins with a rising edge of the output control bit. After this time has elapsed, the output is monitored, and error states are reported by diagnostics.

The *Surveillance-Timeout* parameter can be set from 0 to 255 ms. When an output channel is in static state, i.e., when the channel is permanently switched on or off, the typical filter value (not changeable) before a diagnostic message is 5 ms.

Default: 80 ms

IO-Link Input/Output Data Swapping

With the following parameters, the IO-Link byte data order can be setup separately for Input and Output data direction.

- ▶ Swapping Mode:

The byte order swapping will be made for the selected count of data types or for the complete length of I/O data with the selected Data Type (Word = 2 Bytes or DWord = 4 Bytes).

Default: Off

► Swapping Data Type:

The swapping can be setup to Word (2 Bytes) or DWord (4 Bytes):

- Word Swapping: Byte 1 - Byte 2 => Byte 2 - Byte 1
- DWord Swapping: Byte 1 - Byte 4 => Byte 4 - Byte 1

The Data Type value has no effect when the Swapping Mode is setup to "Off".

Default: Word

► Swapping Offset:

A swapping offset in bytes can be setup in dependency of the configured I/O data length.

When setup to "2", the swapping will be processed from the 3rd Byte.

Default: 0

8.6.2 Failsafe port parameters for Ch. A in IO-Link mode

The following values are selectable (for output data only):

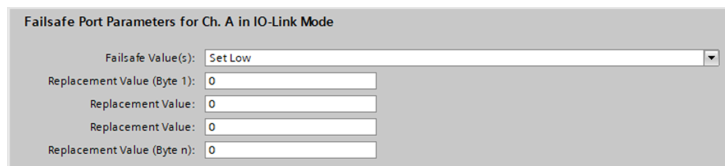

Failsafe Port Parameters for Ch. A in IO-Link Mode	
Failsafe Value(s):	Set Low
Replacement Value (Byte 1):	0
Replacement Value:	0
Replacement Value:	0
Replacement Value (Byte n):	0

Figure 26: Failsafe Configuration

For a proper function of the IO-Link failsafe values, the IO-Link Device parameters should be set in the same way, if possible. In the case of a lost network connection, the IO-Link Master sends, according to its failsafe configuration, output data to the IO-Link Device. If the IO-Link Device connection is lost, the IO-Link Device uses the failsafe options parameterized inside the device, if supported.

When the device supports a failsafe mechanism, choose the option *IO-Link Master Command*.

Set Low

All bits of the output data with a value of "0" are transmitted to the IO-Link Device. (Default setting)

Set High

All bits of the output data with a value of "1" are transmitted to the IO-Link Device.

Hold Last

The last valid output value received by the control unit is continuously and cyclically transmitted to the IO-Link Device.

For proper *Hold Last* behavior, the appropriate IOL-Device parameters must also be set to *Hold Last*.

Replacement Value

If this option is selected, the value entered in the **Replacement Value** input field described [below](#) is continuously and cyclically transmitted to the IO-Link Device.

IO-Link Master Command

The *IO-Link Master Command* option allows the use of IO-Link-specific mechanisms for valid/invalid output process data. Thus, the device itself determines the behavior.

Replacement Value

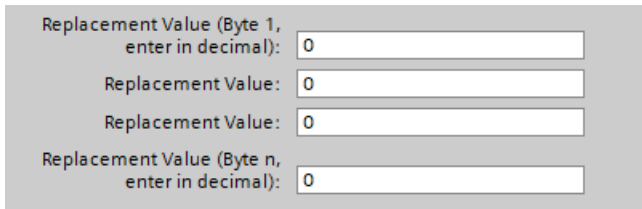

The screenshot shows a configuration window with four input fields, each containing the value '0'. The labels for the fields are: 'Replacement Value (Byte 1, enter in decimal):', 'Replacement Value:', 'Replacement Value:', and 'Replacement Value (Byte n, enter in decimal):'.

Figure 27: Byte data

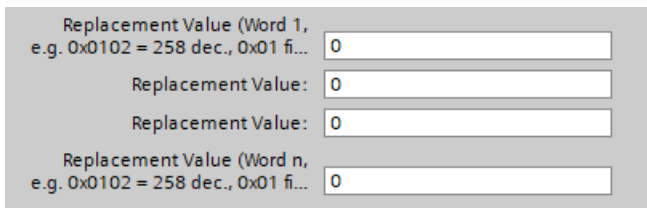

The screenshot shows a configuration window with four input fields, each containing the value '0'. The labels for the fields are: 'Replacement Value (Word 1, e.g. 0x0102 = 258 dec., 0x01 fi...', 'Replacement Value:', 'Replacement Value:', and 'Replacement Value (Word n, e.g. 0x0102 = 258 dec., 0x01 fi...'.

Figure 28: Word data

If the "Fail Safe Value(s)" option is set to "Replacement Value", the substitute value(s) entered in this/these input field(s) is/are used.

The value must be entered as a decimal value. Depending on the configured data length, the values must be entered as bytes (0-255) or word decimal values (0-65535) in the order shown.

- ▶ Byte 1 = high order byte (UINT8), in decimal
- ▶ Byte n = low order byte (UINT8), in decimal

- ▶ Word 1 = high order word (UINT16), in decimal
- ▶ Word n = low order word (UINT16), in decimal

"Word" examples: 0x0102 = 258 dec., 0x01 = first byte for IO-Link Device,
0x02 = second byte for IO-Link Device.

8.6.3 Standardized port parameters

Digital Mode, Ch. B

With this parameter the mode of channel B can be defined. The following modes are available:

- ▶ Disabled
- ▶ Digital Input
- ▶ Digital Output

Default: Digital Input

Port Diagnostic, Ch. A

The IO-Link Master port diagnostics and the IO-Link Device alarms of type "error" or "warning" can be enabled or disabled over this option.

Default: Enabled

Process Alarm, Ch. A (Device Notifications)

The IO-Link Device alarm notifications can be enabled or disabled with this option. Disabled means, that all notification alarm types from every IO-Link Device will be suppressed by the IO-Link Master. They will be not forwarded by PROFINET alarms to the controller.

Default: Enabled

Configuration Source, Ch. A

- ▶ PROFINET IO Controller:

The IO-Link Master port configuration will be assigned by the PROFINET IO Controller.

- ▶ Port and Device Configuration Tool (not supported yet):

The IO-Link Master port configuration will be assigned by an external IO-Link Port and Device Configuration Tool.

Default: PROFINET IO Controller

Input Fraction, Ch. A

If the user configures a sub-slot module with less than the real input data of the device, the IO-Link Master sends as much as possible IO-Link Device input bytes to the PLC inclusive the PQI byte of the sub-slot module. As a consequence, only "0" up to (Device Input Length - 1) octets of the input data of the device can be mapped to the PROFINET process input data of the IO-Link Master. If this option is disabled, a data length mismatch alarm is active in the case of a mismatching input data length. In case of an output data mismatch, a process data mismatch diagnosis will be generated independently of the selected "Input Fraction" setting.

Default: Disabled

Pull/Plug, Ch. A

Enables or Disables Pull/Plug alarms of an IOL-Device (Add/Remove Submodule). A failure or the return of an IO-Link Device can be mapped via PROFINET Plug or Pull alarms. This mapping is independent from any phase such as power-up or start-up.

► Plug Alarms:

- Ready to Operate (IOL-Device is ready)
- COM Fault (incorrect device or other problems) – IOL-Device started but not ready due to fault.

► Pull Alarms:

- COM Fault (No IOL-Device)

In the "Disabled" option, channel diagnostics will be generated in case of losing an IO-Link Device.

Default: Enabled

Port Mode, Ch. A

► Deactivated:

With the "Deactivated" option, an IO-Link port can be configured for later use. No diagnostics are generated if the IO-Link Device is not connected.

► IO-Link - Autostart:

With the "Plug&Play" option no explicit port configuration is needed. Basic assignments such as *Validation and Backup* (Inspection Level), *Port Cycle Time*, *Vendor ID* and *Device ID* are not required.

► IO-Link - Manual:

Explicit port configuration possible for *Validation and Backup* (Inspection Level), *Port Cycle Time*, *Vendor ID* and *Device ID*. These Parameters are GSD based and can be set over a PROFINET engineering system.

Default: IO-Link Autostart

Overview and dependencies of the *Port Mode* configuration type:

Feature	IO-Link - autostart	IO-Link - manual (GSD)
Access on Process Data (PD)	Yes	Yes
Diagnostics of port & device	Yes	Yes
I&M data (IM0) access	Yes	Yes
Device check (consolidated/real)	No	Yes
Backup & Restore	No	Yes
Device parameterization (PDCT)	No	No
Commissioning (online)	No	No

Table 11: Overview, port mode config types

Validation and Backup, Ch. A

For using the *Validation and Backup* functionality of the IOL-Master, the port mode must be set to *IO-Link - manual*.

In dependency of the *Validation and Backup* setting, the entry of the parameters *Vendor ID* and *Device ID* might be obligatory.

► No IOL-Device check (default):

No check of connected *Vendor ID* or *Device ID* and no *Backup and Restore* support of the IOL-Master backup memory.

► Type compatible (V1.0) IOL-Device:

Type compatible according to IO-Link specification V1.0 including validation of *Vendor ID* and *Device ID*. IO-Link specification V1.0 does not support IO-Link Master parameter backup memory and restore function.

► Type compatible (V1.1) IOL-Device:

Type compatible according to IO-Link specification V1.1, check of *Vendor ID* and *Device ID* by IOL-Master.

► Type compatible (V1.1) IOL-Device with Backup & Restore:

Type compatible according to IO-Link specification V1.1, check of *Vendor ID* and *Device ID* by IOL-Master with *Backup* (IOL-Device to IOL-Master) and *Restore* (IOL-Master to IOL-Device) of the IOL-Device parameters.

Pay attention to the following explanations regarding *Backup and Restore* conditions:

Backup (Upload / IOL-Device to IOL-Master):

During the first connection to an IO-Link Device after enabling this mode, the IOL-Master uploads the IOL-Device parameter into the backup memory. (In this case the backup memory had been empty. Watch below for further information about resetting the IO-Link Master parameter backup memory.)

An upload will also be performed, when the IO-Link Device has set the DS_UPLOAD_FLAG (Data Storage Upload Flag). This IOL-Device flag can be set in two ways:

- Parameters written to IOL-Device in *Block Parameter* mode: An IO-Link Device sets the DS_UPLOAD_FLAG self-dependent, if the parameters were written in block parameter mode to the IO-Link Device with the last system command ParamDownloadStore (e.g. by a third party USB IO-Link Master for commissioning).
- Parameters written to IOL-Device in *Single Parameter* mode: If parameters are written to the device in single parameter mode (e.g. one Sub-Index of a parameter Index), the device parameter backup memory on the IOL-Master can be updated by using the ParamDownloadStore system command (Index 0x0002, Sub-Index 0x00, Value 0x05). This command sets the DS_UPLOAD_FLAG (backup request) on the IOL-Device in direction of the IOL-Master, and thus the IOL-Master performs a transfer from IOL-Device to IOL-Master backup memory.

Restore (Download / IOL-Master to IOL-Device):

For each new connection to an IO-Link Device, the IOL-Master compares the stored parameters with the IOL-Device parameters and downloads the stored backup parameters to the IOL-Device in case of differences.

The restore procedure can be blocked by the IO-Link Device via the *Device Access Locks* parameter when supported by the IO-Link Device (Index 0x000C, refer to vendor specific IO-Link Device documentation).

► Type compatible (V1.1) IOL-Device with Restore:

Type compatible according to IO-Link specification V1.1, check of *Vendor ID* and *Device ID* by IOL-Master with *Restore* (IOL-Master to IOL-Device) of the IOL-Device parameters.

Pay attention to the following explanations regarding *Restore* conditions:

Restore (Download / IOL-Master to IOL-Device):

During the first connection to an IO-Link Device after enabling this mode, the IOL-Master uploads the IOL-Device parameters once into the backup memory.

With each further connection to an IO-Link Device, the IOL-Master compares the stored parameters with the IOL-Device parameters and downloads the stored backup parameters to the IOL-Device in case of differences.

In the *Restore* mode no change of the IOL-Device parameters will be stored in the IOL-Master backup memory. When the IOL-Device sets the DS_UPLOAD_FLAG in this mode, the IOL-Device parameters will be restored from the IOL-Master.

The restore procedure can be blocked by the IO-Link Device via the *Device Access Locks* parameter when supported by the IO-Link Device (Index 0x000C, refer to vendor specific IO-Link Device documentation).

- ▶ Reset conditions of IO-Link Master parameter backup memory:

The IO-Link Master backup memory will be deleted by the following events:

- IO-Link Master factory reset
- A port configuration change, e.g. from “Digital-Input” to “IO-Link Mode”
- A change in the *Validation and Backup* settings, e.g. from “No IOL-Device Check” to “Type compatible IOL-Device (V1.1) with Backup & Restore”

For further information refer to the ‘IO-Link Interface and System Specification’ version 1.1.3 which can be downloaded from <https://io-link.com/>.

Default: No IOL-Device check



Attention: An IO-Link Device sets the “upload flag” self-dependent, if parameter were written in block mode to the IO-Link Device.

Port Cycle Time, Ch. A

(Port mode *IO-Link - manual* required)

- ▶ As fast as possible:

The IO-Link Master uses the max. supported IOL-Device update cycle time limited by the max. supported IOL-Master cycle time for the cyclic I/O data update between IOL-Master and IOL-Device.

- ▶ 1.6, 3.2, 4.8, 8, 20.8, 40, 80, 120 ms:

The cycle time can be set manually to the provided options. This option can be used e.g. for IOL-Device modules which are connected over inductive couplers. Inductive couplers are normally the bottleneck in the update cycle time between IOL-Master and IOL-Device. In this case, please refer to the data sheet of the inductive coupler.

Default: As fast as possible

Vendor ID, Ch. A

(Port mode *IO-Link - manual* required)

The Vendor ID of the connected IOL-Device used can be entered as a decimal value [0 ... 65535] and will be in used in dependency of the Validation and Backup settings for the validation of the type compatibility.

Default: 0

Device ID, Ch. A

(Port mode *IO-Link - manual* required)

The *Device ID* of the connected IOL-Device can be entered as a decimal value [0 ... 65535] and will be in used in dependency of the *Validation and Backup* settings for the validation of the type compatibility.

Default: 0

8.7 IO-Link Device Parameterization

8.7.1 SIEMENS IO-Link library

The SIEMENS "LIO_LINK_DEVICE" function block (FB50004) can perform acyclic writing or reading data of an IOL-Device connected to the IO-Link Master.

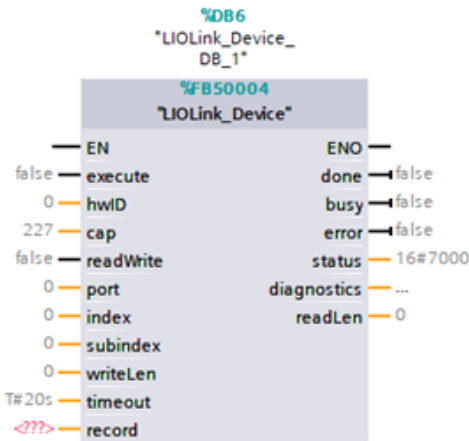

Figure 29: "LIO_LINK_DEVICE" FB in STEP 7 V17

IOL-Device data are uniquely addressed via the index and the sub-index and can be accessed or written via the hardware identifier of the status/control module (ID) inputs, the client access point (CAP = 0xB400) and the corresponding IO-Link port (PORT: 1 for X7 and 2 for X8).

The following TIA project shows the used hardware identifier of the sub-module for port X7 (272) with Write/Read examples. Alternatively, the hardware identifier of the Status/Control module can also be used (268 in this example).

The screenshot displays the Siemens TIA Portal interface for configuring an IO-Link device. The main window shows the 'Device overview' table, which lists the modules for rack 0. The 'IO-Link Master' and 'IO-Link Slave' modules are highlighted in red and blue, respectively. The 'Properties' window shows a list of hardware system constants for the IO-Link device, with the 'IO-Link Master' and 'IO-Link Slave' entries highlighted in red and blue, respectively.

Module	Rack	Slot	I address	Q address	Type
0980-55L-3031-121-007D	0	0	PROFINET...	0980-55L-3031-121-007D...	
Phi-O	0	0	PROFINET...	0980-55L-3031-121-007D...	
Global Device Module_1	0	1	0.3		Global Device Module
X1-16: BI-FDI 4-FDI_1	0	2	X1-16: F...	4...11 4...9	X1-16: BI-FDI 4-FDI
X1-16: IO-Link Master_1	0	3		0.1	X1-16: IO-Link Master
Status DI Control DO	0	3	X1 12...13	0.1	Status DI Control DO
IO-Link IO 4x Bytes + P...	0	3	X1 14...18	10...15	IO-Link IO 4x Bytes + P...
Digital in (AI) Digital (B)	0	3	X1 18	19	Digital in (AI) Digital (B)
	0	4			
	0	5			
	0	6			

Name	Type	Hardware ident.	Used by	Comment
0980-55L-3031-121-007D-Phi-O-Port_MDI_108_MDI_1	Hw_Interface	260	PLC_5	
0980-55L-3031-121-007D-Phi-O-Port_MDI_108_MDI_1	Hw_Interface	241	PLC_5	
0980-55L-3031-121-007D-Phi-O	Hw_Interface	259	PLC_5	
0980-55L-3031-121-007D-Proxy	Hw_SubModule	271	PLC_5	
0980-55L-3031-121-007D-Head	Hw_SubModule	262	PLC_5	
0980-55L-3031-121-007D-Global_Device_Module_1	Hw_SubModule	264	PLC_5	
0980-55L-3031-121-007D-X1-16-BI-FDI-4-FDI_1	Hw_SubModule	266	PLC_5	
0980-55L-3031-121-007D-X1-16-IO-Link_Master_1	Hw_SubModule	263	PLC_5	
0980-55L-3031-121-007D-X1-16-IO-Link_Master_1-Status_DI_Control_DO	Hw_SubModule	268	PLC_5	
0980-55L-3031-121-007D-X1-16-IO-Link_Master_1-IO-Link_IO_4_Bytes_P...	Hw_SubModule	273	PLC_5	
0980-55L-3031-121-007D-X1-16-IO-Link_Master_1-Digital_in_AI_Digital_BI	Hw_SubModule	265	PLC_5	

Figure 30: TIA project: Write/Read example with FB50004

8.7.1.1 SIEMENS function block FB50004 – write example

The following is a write example for an IO-Link Device on port X7 at the application tag parameter (**IO_INDEX=24**). The input data are in decimal. The write data are in hexadecimal. The written value is "test" (= 74 / 65 / 73 / 74 in HEX).

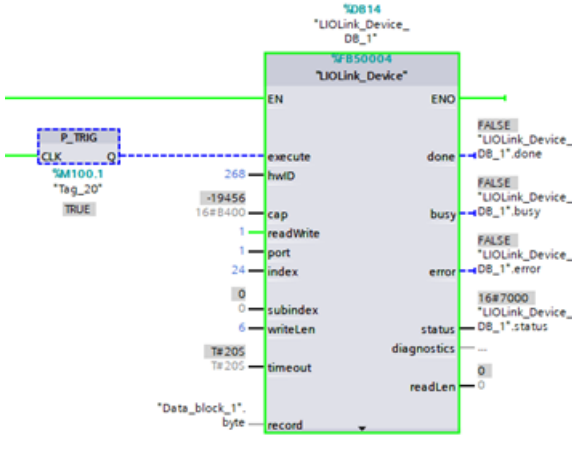
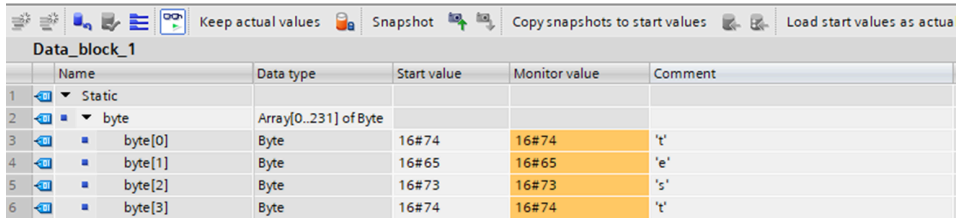

Figure 31: Write example for FB50004

Name	Data type	Start value	Monitor value	Status	Comment
execute	Bool	False	FALSE		Anforderung zum Ausführen der Funktion
hwID	HW_ID	268	268		Hardware-Identifikation des IO-Link-Mastermoduls (Submodul für ET 2000x PN)
cap	Int	16#B400	16#B400		Client Access Point (CAP), Sub-ID für ET 2000x PN, Client-IO-Link, serial-IO-Link (207)
readWrite	Bool	False	FALSE		FALSE: Lesen, TRUE: Schreiben
port	Int	1	1		Port am IO-Link-Master-Modul
index	Int	24	24		Adressparameter-Index (IO-Link Device): 0, 32767; IO-ID: 65535; Funktionsfunktionen
subindex	Int	0	0		Adressparameter-Subindex (IO-Link Device): 0: vollständige Aufzeichnung; 1-255: Einzelparameter
writeLen	Int	6	6		Länge der Schreibdaten (Bytes/Dateien): 1, 252
timeout	Time	T#200	T#200		Zeit, nach der die Anfrage abgebrochen wird
pollingPeriod	Time	T#1000E	T#1000E		

Figure 32: Input control data for write request with FB50004



	Name	Data type	Start value	Monitor value	Comment
1	Static				
2	byte	Array[0..231] of Byte			
3	byte[0]	Byte	16#74	16#74	't'
4	byte[1]	Byte	16#65	16#65	'e'
5	byte[2]	Byte	16#73	16#73	's'
6	byte[3]	Byte	16#74	16#74	't'

Figure 33: Data to be written with FB50004

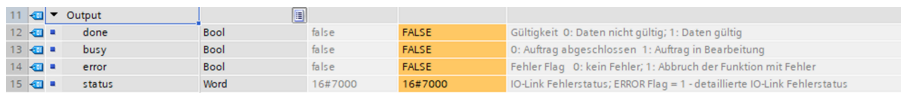

	Output				
12	done	Bool	false	FALSE	Gültigkeit 0: Daten nicht gültig; 1: Daten gültig
13	busy	Bool	false	FALSE	0: Auftrag abgeschlossen 1: Auftrag in Bearbeitung
14	error	Bool	false	FALSE	Fehler Flag 0: kein Fehler; 1: Abbruch der Funktion mit Fehler
15	status	Word	16#7000	16#7000	IO-Link Fehlerstatus; ERROR Flag = 1 - detaillierte IO-Link Fehlerstatus

Figure 34: Output status for write request with FB50004

8.7.1.2 SIEMENS function block FB50004 – read example

The following is a read example for an IOL-Device on port X7 at the application tag parameter (**IOL_INDEX=24**). The input data are in decimal. The read data are in hexadecimal. The previously written value "test" (= 74 / 65 / 73 / 74 in HEX) will be read here.

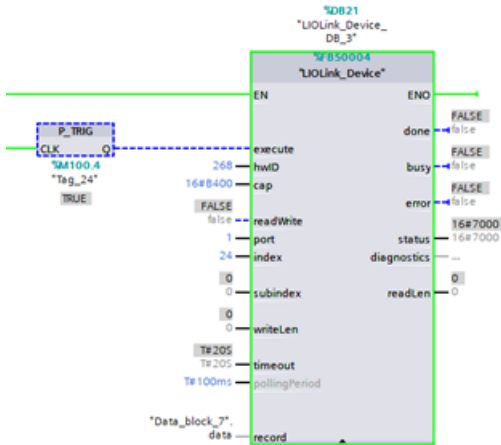

Figure 35: Read example for FB50004

name	Data type	Start value	Monitor value	Comment
execute	Bool	false	FALSE	Anforderung zum Ausführen der Funktion
hwID	HW_ID	268	268	Hardware-Identifikation des IO-Link-Akquisiermoduls (Submodul für ET 200eco P10)
cap	Int	16#B400	19456	Client Access Point (CAPS, 0#B400 für ET 200eco P10, 0#B400 IO-Link, sonst 0#0000 0275)
readWrite	Bool	false	FALSE	FALSE: lesen, TRUE: schreiben
port	Int	1	1	Port am IO-Link-Akquisiermodul
index	Int	24	24	Adressparameterindex (IO-Link Device): 0: 32767; IO-Link; 85535: Funktionsnamen
subindex	Int	0	0	Adressparameter Subindex (IO-Link Device): 0: vollständige Aufzeichnung; 1-255: Einzelparameter
writeLen	Int	0	0	Länge der Schreibdaten (Bytes/Bytes): 1-255
timeout	Time	TR 205	TR 205	Zeit, nach der die Anfrage abgebrochen wird
pollingPeriod	Time	TR 100ms	TR 100ms	

Figure 36: Control data for read request with FB50004

name	Data type	Start value	Monitor value	Comment
done	Bool	false	FALSE	Gültigkeit 0: Daten nicht gültig; 1: Daten gültig
busy	Bool	false	FALSE	0: Auftrag abgeschlossen 1: Auftrag in Bearbeitung
error	Bool	false	FALSE	Fehler Flag 0: kein Fehler; 1: Abbruch der Funktion mit Fehler
status	Wort	16#7000	16#7000	IO-Link Fehlerstatus; ERROR Flag = 1 - detaillierte IO-Link Fehlerstatus

Figure 37: Status data for read request with FB50004

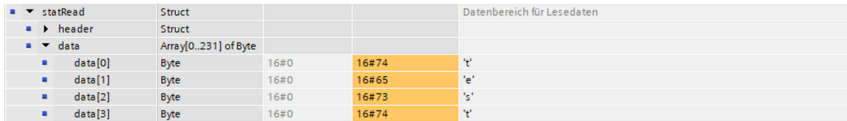

		Datenbereich für Lesedaten		
statRead	Struct			
header	Struct			
data	Array[0..231] of Byte			
data[0]	Byte	16#0	16#74	't'
data[1]	Byte	16#0	16#65	'e'
data[2]	Byte	16#0	16#73	's'
data[3]	Byte	16#0	16#74	't'

Figure 38: Read data from application tag of the IO-Link Device with FB50004

8.7.2 SIEMENS WRREC and RDREC

The Reading and Writing Parameters from the PLC over the IOL-Master to the connected IOL-Device modules can also be handled by using the SIEMENS Function Blocks *SFB52/RDREC* and *SFB53/WRREC*.

8.7.2.1 Write sequence

The following figure shows the sequence of WRREC and RDREC calls for writing data:

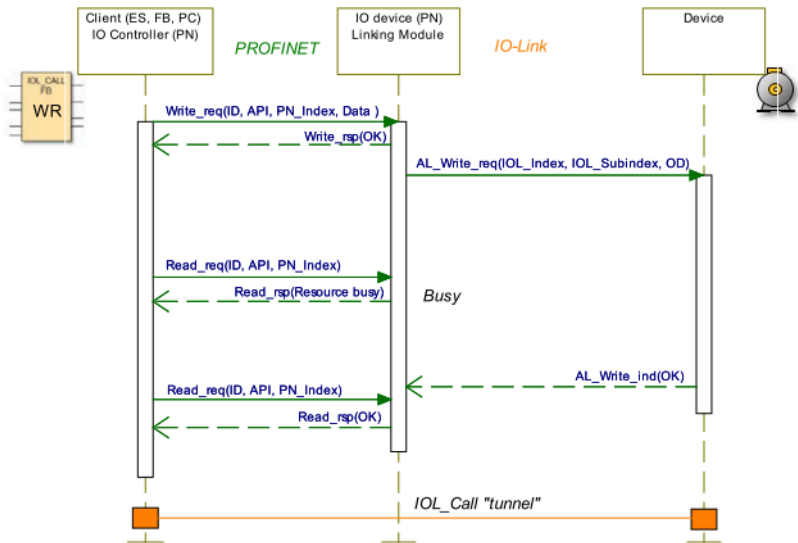

The following table shows the sequence with example data compared to the *FB50004*. The *FB50004* uses the WRREC and RDREC blocks also internally:

FB50004 Call	WRREC				RDREC	RDREC Response		
ID (address proxy)	ID (address proxy)				ID (address proxy)			
CAP	PN_Index = 0xB400				PN_Index = 0xB400			
WR	Data Header	Function (fixed)	0x08	Unsigned8		Data Header	Function (fixed)	0x08
Port		Port	1 .. 2	Unsigned8			Port	1 .. 2
		FI_Index (Fixed)	0xFE4A	Unsigned16			FI_Index (Fixed)	0xFE4A
		Control/Status (→Write)	0x02	Unsigned8			Control/Status	0x00
IOL-Index		IOL-Index (0 .. 32767; 65535)	0x...	Unsigned16			IOL-Index (0 .. 32767; 65535)	0x...
IOLSubIndex		IOL-Sub-Index (0 .. 255)	0x00	Unsigned8			IOL-Sub-Index (0 .. 255)	0x00
IOL-Data		WR-Data					Data (opt. Error PDU)	

Table 12: WRREC ID



Attention: Unsigned16 values must be entered in Big Endian format for PROFINET.

Bit 7	Bit 6	Bit 5	Bit 4	Bit3	Bit2	Bit 1	Bit 0	Definition of Control octets
0	0	0	0	0	0	0	0	Cancel / Release IOL_CALL
0	0	0	0	0	0	0	1	IDLE Sequence
0	0	0	0	0	0	1	0	Write On-request Data or Port function
0	0	0	0	0	0	1	1	Read On-request Data
Other codings								Reserved

Table 13: Control Parameter

Bit 7	Bit 6	Bit 5	Bit 4	Bit3	Bit2	Bit 1	Bit 0	Definition of Status octets
0	0	0	0	0	0	0	0	Done / Transfer terminated
0	0	0	0	0	0	0	1	IDLE Sequence
1	0	0	0	0	0	0	0	IOL_Error PDU
Other codings								Reserved

Table 14: Status Parameter

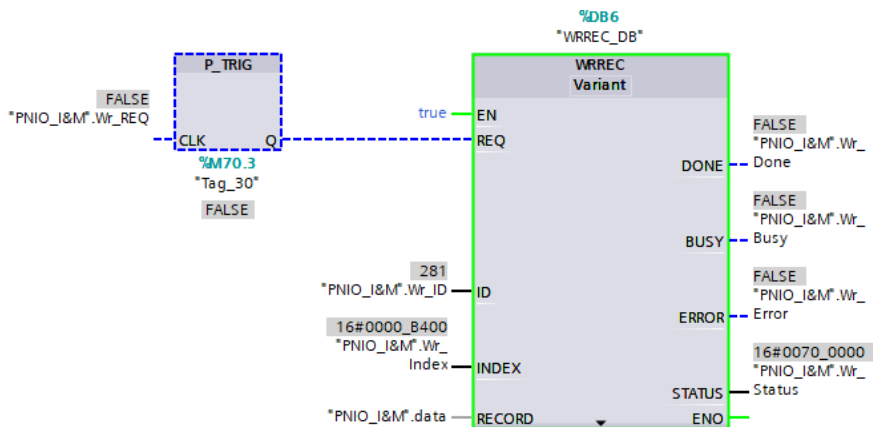

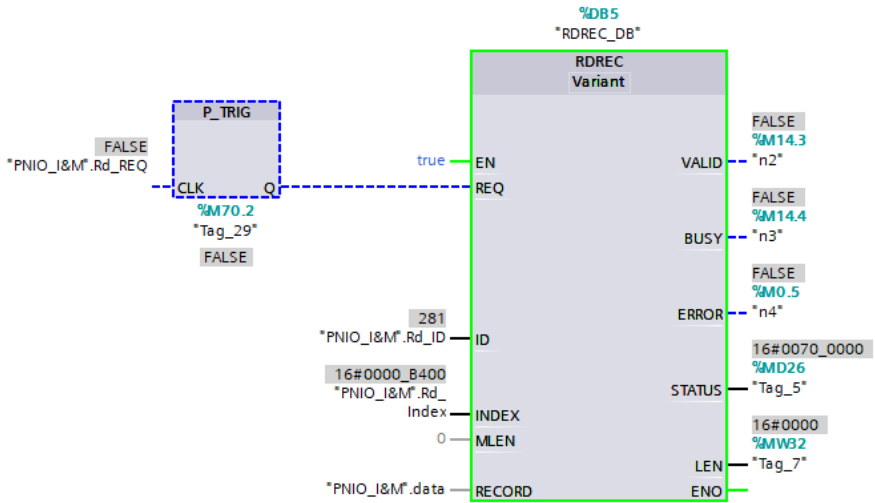























































		Wr_REQ	Bool	false	FALSE
		Wr_Index	DWord	16#0	16#0000_B400
		Wr_ID	HW_IO	0	281
		Wr_Done	Bool	false	FALSE
		Wr_Busy	Bool	false	FALSE
		Wr_Error	Bool	false	FALSE
		Wr_Status	DWord	16#0	16#0000_0000
		Wr_Len	UInt	0	0
		▼ data	Array[0..39] of Byte		
		data[0]	Byte	16#0	16#08
		data[1]	Byte	16#0	16#05
		data[2]	Byte	16#0	16#FE
		data[3]	Byte	16#0	16#4A
		data[4]	Byte	16#0	16#02
		data[5]	Byte	16#0	16#00
		data[6]	Byte	16#0	16#18
		data[7]	Byte	16#0	16#00
		data[8]	Byte	16#0	16#54
		data[9]	Byte	16#0	16#45
		data[10]	Byte	16#0	16#53
		data[11]	Byte	16#0	16#54
		data[12]	Byte	16#0	16#00
		data[13]	Byte	16#0	16#00
		data[14]	Byte	16#0	16#00
		data[15]	Byte	16#0	16#00
		data[16]	Byte	16#0	16#00
		data[17]	Byte	16#0	16#00

Figure 39: Example of data before writing

		Wr_REQ	Bool		false	TRUE
		Wr_Index	DWord		16#0	16#0000_B400
		Wr_ID	HW_IO		0	281
		Wr_Done	Bool		false	FALSE
		Wr_Busy	Bool		false	FALSE
		Wr_Error	Bool		false	FALSE
		Wr_Status	DWord		16#0	16#0000_0000
		Wr_Len	UInt		0	0
		▼ data	Array[0..39] of Byte			
		data[0]	Byte		16#0	16#08
		data[1]	Byte		16#0	16#05
		data[2]	Byte		16#0	16#FE
		data[3]	Byte		16#0	16#4A
		data[4]	Byte		16#0	16#02
		data[5]	Byte		16#0	16#00
		data[6]	Byte		16#0	16#18
		data[7]	Byte		16#0	16#00
		data[8]	Byte		16#0	16#54
		data[9]	Byte		16#0	16#45
		data[10]	Byte		16#0	16#53
		data[11]	Byte		16#0	16#54
		data[12]	Byte		16#0	16#00
		data[13]	Byte		16#0	16#00
		data[14]	Byte		16#0	16#00
		data[15]	Byte		16#0	16#00
		data[16]	Byte		16#0	16#00
		data[17]	Byte		16#0	16#00

Figure 40: Example of data after writing

Name	Data type	Start value	Monitor value
Static			
Rd_REQ	Bool	false	TRUE
Rd_Index	DWord	16#0	16#0000_B400
Rd_ID	HW_IO	0	281
Rd_Valid	Bool	false	FALSE
Rd_Busy	Bool	false	FALSE
Rd_Error	Bool	false	FALSE
Rd_Status	DWord	16#0	16#0000_0000
Rd_Len	UInt	0	0
data	Array[0..39] of Byte		
data[0]	Byte	16#0	16#08
data[1]	Byte	16#0	16#05
data[2]	Byte	16#0	16#FE
data[3]	Byte	16#0	16#4A
data[4]	Byte	16#0	16#00
data[5]	Byte	16#0	16#00
data[6]	Byte	16#0	16#18
data[7]	Byte	16#0	16#00
data[8]	Byte	16#0	16#54
data[9]	Byte	16#0	16#45
data[10]	Byte	16#0	16#53
data[11]	Byte	16#0	16#54
data[12]	Byte	16#0	16#00
data[13]	Byte	16#0	16#00
data[14]	Byte	16#0	16#00
data[15]	Byte	16#0	16#00
data[16]	Byte	16#0	16#00
data[17]	Byte	16#0	16#00

Figure 41: Read data after writing

8.7.2.2 Read sequence

The following figure shows the sequence of WRREC and RDREC calls for reading data:

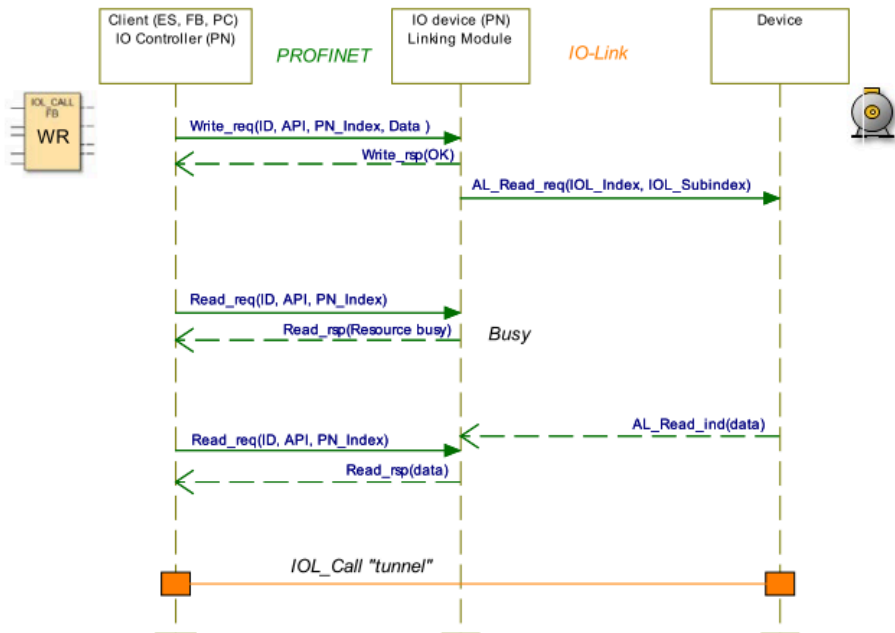

The following table shows the sequence with example data compared to the *FB50004*. The *FB50004* uses the WRREC and RDREC blocks also internally:

FB50004 Call	WRREC				RDREC	RDREC Response		
ID (address proxy)	ID (address proxy)				ID (address proxy)			
CAP	PN_Index = 0xB400				PN_Index = 0xB400			
WR	Data Header	Function (fixed)	0x08	Unsigned8		Data Header	Function (fixed)	0x08
Port		Port	1 .. 2	Unsigned8			Port	1 .. 2
		FI_Index (Fixed)	0xFE4A	Unsigned16			FI_Index (Fixed)	0xFE4A
		Control/Status (→Read)	0x03	Unsigned8			Control/Status	0x00
IOL-Index		IOL-Index (0 .. 32767; 65535)	0x...	Unsigned16			IOL-Index (0 .. 32767; 65535)	0x...
IOLSubIndex		IOL-Sub-Index (0 .. 255)	0x00	Unsigned8			IOL-Sub-Index (0 .. 255)	0x00
IOL-Data		–					Data (opt. Error PDU)	

Table 15: RDREC ID



Attention: Unsigned16 values must be entered in Big Endian format for PROFINET.

Bit 7	Bit 6	Bit 5	Bit 4	Bit3	Bit2	Bit 1	Bit 0	Definition of Control octets
0	0	0	0	0	0	0	0	Cancel / Release IOL_CALL
0	0	0	0	0	0	0	1	IDLE Sequence
0	0	0	0	0	0	1	0	Write On-request Data or Port function
0	0	0	0	0	0	1	1	Read On-request Data
Other codings								Reserved

Table 16: Control Parameter

Bit 7	Bit 6	Bit 5	Bit 4	Bit3	Bit2	Bit 1	Bit 0	Definition of Status octets
0	0	0	0	0	0	0	0	Done / Transfer terminated
0	0	0	0	0	0	0	1	IDLE Sequence
1	0	0	0	0	0	0	0	IOL_Error PDU
Other codings								Reserved

Table 17: Status Parameter

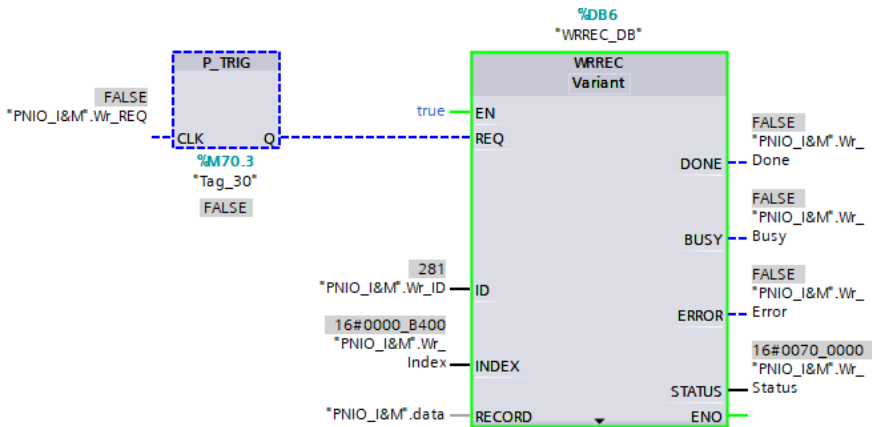

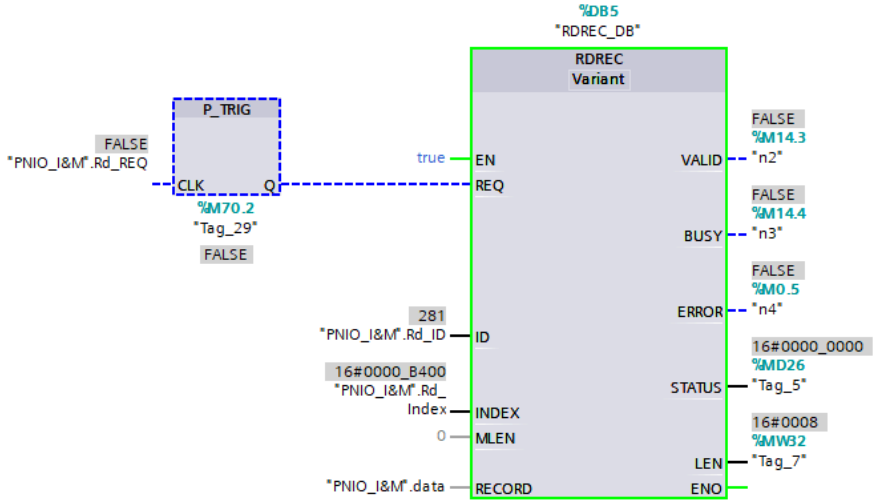

Static				
Rd_REQ	Bool	false	FALSE	
Rd_Index	DWord	16#0	16#0000_B400	
Rd_ID	HW_IO	0	281	
Rd_Valid	Bool	false	FALSE	
Rd_Busy	Bool	false	FALSE	
Rd_Error	Bool	false	FALSE	
Rd_Status	DWord	16#0	16#0000_0000	
Rd_Len	UInt	0	0	
Wr_REQ	Bool	false	FALSE	
Wr_Index	DWord	16#0	16#0000_B400	
Wr_ID	HW_IO	0	281	
Wr_Done	Bool	false	FALSE	
Wr_Busy	Bool	false	FALSE	
Wr_Error	Bool	false	FALSE	
Wr_Status	DWord	16#0	16#0000_0000	
Wr_Len	UInt	0	0	
data	Array[0..39] of Byte			
data[0]	Byte	16#0	16#08	
data[1]	Byte	16#0	16#05	
data[2]	Byte	16#0	16#FE	
data[3]	Byte	16#0	16#4A	
data[4]	Byte	16#0	16#03	
data[5]	Byte	16#0	16#00	
data[6]	Byte	16#0	16#18	
data[7]	Byte	16#0	16#00	
data[8]	Byte	16#0	16#00	
data[9]	Byte	16#0	16#00	
data[10]	Byte	16#0	16#00	
data[11]	Byte	16#0	16#00	
data[12]	Byte	16#0	16#00	
data[13]	Byte	16#0	16#00	
data[14]	Byte	16#0	16#00	
data[15]	Byte	16#0	16#00	
data[16]	Byte	16#0	16#00	
data[17]	Byte	16#0	16#00	

Figure 42: Example of data before reading



























	<input type="checkbox"/>	Wr_REQ	Bool	false	TRUE
	<input type="checkbox"/>	Wr_Index	DWord	16#0	16#0000_B400
	<input type="checkbox"/>	Wr_ID	HW_IO	0	281
	<input type="checkbox"/>	Wr_Done	Bool	false	FALSE
	<input type="checkbox"/>	Wr_Busy	Bool	false	FALSE
	<input type="checkbox"/>	Wr_Error	Bool	false	FALSE
	<input type="checkbox"/>	Wr_Status	DWord	16#0	16#0000_0000
	<input type="checkbox"/>	Wr_Len	UInt	0	0
	<input type="checkbox"/>	▼ data	Array[0..39] of Byte		
	<input type="checkbox"/>	data[0]	Byte	16#0	16#08
	<input type="checkbox"/>	data[1]	Byte	16#0	16#05
	<input type="checkbox"/>	data[2]	Byte	16#0	16#FE
	<input type="checkbox"/>	data[3]	Byte	16#0	16#4A
	<input type="checkbox"/>	data[4]	Byte	16#0	16#03
	<input type="checkbox"/>	data[5]	Byte	16#0	16#00
	<input type="checkbox"/>	data[6]	Byte	16#0	16#18
	<input type="checkbox"/>	data[7]	Byte	16#0	16#00
	<input type="checkbox"/>	data[8]	Byte	16#0	16#00
	<input type="checkbox"/>	data[9]	Byte	16#0	16#00
	<input type="checkbox"/>	data[10]	Byte	16#0	16#00
	<input type="checkbox"/>	data[11]	Byte	16#0	16#00
	<input type="checkbox"/>	data[12]	Byte	16#0	16#00
	<input type="checkbox"/>	data[13]	Byte	16#0	16#00
	<input type="checkbox"/>	data[14]	Byte	16#0	16#00
	<input type="checkbox"/>	data[15]	Byte	16#0	16#00
	<input type="checkbox"/>	data[16]	Byte	16#0	16#00
	<input type="checkbox"/>	data[17]	Byte	16#0	16#00

Figure 43: Example of data after reading

Name	Data type	Start value	Monitor value
▼ Static			
■ Rd_REQ	Bool	false	TRUE
■ Rd_Index	DWord	16#0	16#0000_B400
■ Rd_ID	HW_IO	0	281
■ Rd_Valid	Bool	false	FALSE
■ Rd_Busy	Bool	false	FALSE
■ Rd_Error	Bool	false	FALSE
■ Rd_Status	DWord	16#0	16#0000_0000
■ Rd_Len	UInt	0	0
■ ▼ data	Array[0..39] of Byte		
■ data[0]	Byte	16#0	16#08
■ data[1]	Byte	16#0	16#05
■ data[2]	Byte	16#0	16#FE
■ data[3]	Byte	16#0	16#4A
■ data[4]	Byte	16#0	16#00
■ data[5]	Byte	16#0	16#00
■ data[6]	Byte	16#0	16#18
■ data[7]	Byte	16#0	16#00
■ data[8]	Byte	16#0	16#54
■ data[9]	Byte	16#0	16#45
■ data[10]	Byte	16#0	16#53
■ data[11]	Byte	16#0	16#54
■ data[12]	Byte	16#0	16#00
■ data[13]	Byte	16#0	16#00
■ data[14]	Byte	16#0	16#00
■ data[15]	Byte	16#0	16#00
■ data[16]	Byte	16#0	16#00
■ data[17]	Byte	16#0	16#00

Figure 44: Read data after reading

8.7.2.3 Error PDU for the Read/Write sequence

Offset	Parameter	Content	Data type
0	Port Error	Error Codes detected by the Linking Module or Client	Unsigned16
2	Error Code	IO-Link Error codes according AL_Read/ AL_Write services	Unsigned8
3	Additional Code	IO-Link Error codes according AL_Read/ AL_Write services	Unsigned8

Table 18: Error PDU

Port Error Code	Definition	Coding	Originator
No error	No error detected	0x0000	Server
Reserved	–	0x0001 to 0x06FFF	–
IOL_CALL conflict	Inconsistent Header information	0x7000	Server and/or Client
Incorrect IOL_CALL	Inconsistent Header information (send-/response)	0x7001	Server and/or Client
Port blocked	Port temporary not available	0x7002	Server
Reserved	–	0x7003 to 0x7FFF	–
Timeout	No correct termination of IOL_CALL (Resource Busy detection)	0x8000	Client
Invalid port number	Invalid port Number or port not supported	0x8001	Client and/or Server
Invalid IOL_Index	Invalid Index	0x8002	Client
Invalid IOL_Subindex	Invalid Subindex	0x8003	Client
No Device	No device	0x8004	Client
Reserved	–	0x8005 to 0x8051	–
RDREC Fault	Fault during Read record invocation	0x8052	Client
WRREC Fault	Fault during Write record invocation	0x8053	Client
Unexpected Error	Unspecific Error detected	0x8054	Client
Port Function error	Port function failed	0x8055	Server

Port Error Code	Definition	Coding	Originator
Port Function not available	Port function is not available (in this state)	0x8056	Server
Port Function not supported	Port function (for this port) not supported	0x8057	Server
Manu	Manufacturer specific	0x8058 to 0xFFFF	Server

Table 19: Port Error of Error PDU

8.8 Media Redundancy Protocol (MRP)

Redundant PROFINET communication can be implemented with the LioN-Safety devices via a ring topology without the use of additional switches. An MRP redundancy manager terminates the ring, detects individual failures, and transmits the data packets on the redundant path in case of error.

The following conditions must be met to use MRP:

- ▶ All devices must support MRP.
- ▶ MRP must be enabled on all devices.
- ▶ Connections to the devices are only possible via the ring ports. A mesh topology is not permissible.
- ▶ A max. of 50 devices are permissible in the ring.
- ▶ All devices share the same redundancy domain.
- ▶ One device must be configured as the redundancy manager.
- ▶ All other devices must be configured as redundancy clients.
- ▶ Prioritized boot (FSU) is permissible.
- ▶ The response monitoring time of all devices must be greater than the reconfiguration time (typically 200 ms, min. 90 ms for LioN-Safety devices).
- ▶ It is recommended to use automatic network settings on all devices.

The following figures show a possible MRP ring configuration. The PLC is used as the redundancy manager while all other devices are clients. To detect an individual failure, it is advisable to use the diagnostics alerts.

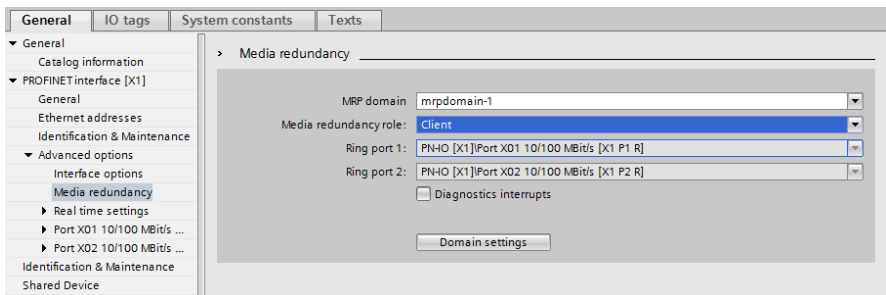

Figure 45: Example of setting up an MRP redundancy client in TIA Portal®

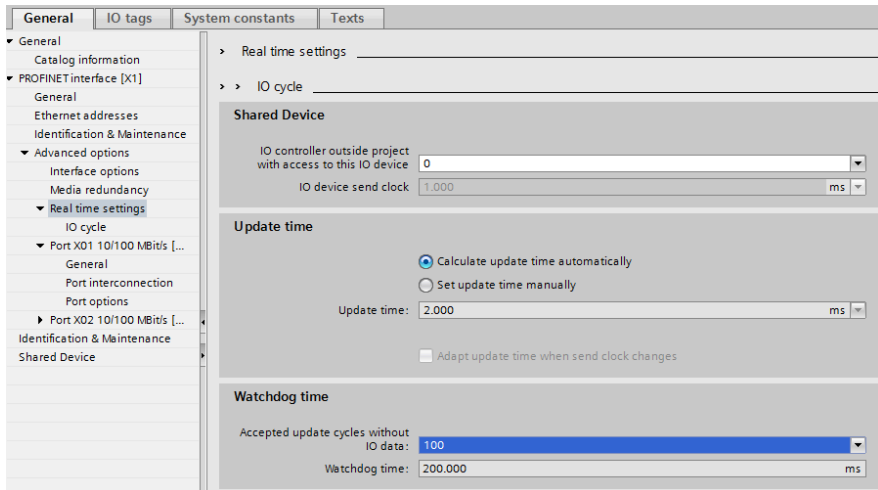

Figure 46: Example of setting up the Watchdog time monitoring in TIA Portal® for using MRP

8.9 Identification & maintenance (I&M)

The PROFINET IO-Link Master has the ability to uniquely identify the devices installed in the system via an electronic nameplate. This device-specific data can be read acyclic by the user at any time. Furthermore, the installation date, location code and further descriptions can be stored in the device during installing the system. The I&M functions provide the following functionality.

8.9.1 Supported I&M features

8.9.1.1 I&M data of the PN-IO Device

For reading (I&M 0 .. 3) and writing (I&M 1 .. 3) I&M data, the appropriate Hardware identifier for *Slot 0: PROFINET Interface X1* must be chosen:

The screenshot displays the TIA Portal interface. At the top left, a 3D model of a rack is shown with a yellow label on the PN-IO module. The main window is divided into two panes. The upper pane, titled 'Device overview', contains a table with the following data:

Module	Rack	Slot	I address	Q address	Type	Art...
0980-55L-3031-121-007D	0	0: PR...			0980 55L 3031-12	93...
PN-IO	0	0: PR...				
Global Device Module_1	0	1	0..3		Global Device Mod...	
X1-X8: 814-FDI 4-FDI_1	0	2: XT...	4...11	4...9	X1-X8: 814-FDI 4-F...	
X7-X8: IO-Link Master_1	0	3			X7-X8: IO-Link Mas...	
Status DI / Control DO	0	3: I	12...13	0..1	Status DI / Control...	
IO-Link IO 4/4 Bytes + P...	0	3:2: X7	16...20	10...13	IO-Link IO 4/4 Byte...	
Digital In (A) / Digital (B)_1	0	3:3: X8	15		Digital In (A) / Digit...	
	0	4				
	0	5				
	0	6				

The lower pane, titled 'PN-IO [PN-IO]', shows the 'Properties' tab with a table of hardware identifiers:

Name	Type	Hardware identi.	Used by	Comment
0980-55L-3031-121-007D-PN-IO-Port_X01_100_MBit_s	Hw_Interface	260	PLC_5	
0980-55L-3031-121-007D-PN-IO-Port_X02_100_MBit_s	Hw_Interface	261	PLC_5	
0980-55L-3031-121-007D-PN-IO	Hw_Interface	259	PLC_5	

Figure 47: TIA Portal® hardware identifier of PROFINET interface for I&M 0-3 RDREC/WRREC

The device-specific I&M features can be read (0 .. 3) or written (1 .. 3) via *Slot 0*. The specified index is used for mapping the data sets.

Data object	Length [byte]	Access	Default value / Description
MANUFACTURER_ID	2	Read	0x016A (Belden Deutschland GmbH)
ORDER_ID	20	Read	Order number of module in ASCII
SERIAL_NUMBER	16	Read	Defined in production process in ASCII
HARDWARE_REVISION	2	Read	Hardware revision of device
SOFTWARE_REVISION	4	Read	Software revision of device
REVISION_COUNTER	2	Read	Incremented for every statically stored parameter change on IO-Link Master (e.g., device name or IP address)
PROFILE_ID	2	Read	0xF600 (Generic device)
PROFILE_SPECIFIC_TYPE	2	Read	0x0003 (I/O modules)
IM_VERSION	2	Read	0x0101 (I&M Version 1.1)
IM_SUPPORTED	2	Read	0x000E (I&M 1 .. 3 & 5 is supported)

Table 20: I&M 0 (Slot 0: PROFINET Interface X1, Index 0xAFF0)

Data object	Length [byte]	Access	Default value / Description
TAG_FUNCTION	32	Read/ Write	0x20 ff. (empty)
TAG_LOCATION	22	Read/ Write	0x20 ff. (empty)

Table 21: I&M 1 (Slot 0: PROFINET Interface X1, Index 0xAFF1)

Data object	Length [byte]	Access	Default value / Description
INSTALLATION_DATE	16	Read/ Write	0x20 ff. (empty); Supported data format is a visible string with a fix length of 16 byte; "YYYY-MM-DD hh:mm" or "YYYY-MM-DD" filled with blank spaces

Table 22: I&M 2 (Slot 0: PROFINET Interface X1, Index 0xAFF2)

Data object	Length [byte]	Access	Default value / Description
DESCRIPTOR	54	Read/ Write	0x20 ff. (empty)

Table 23: I&M 3 (Slot 0: PROFINET Interface X1, Index 0xAFF3)

8.9.1.2 I&M 4 data of the Safety module

Data object	Length [byte]	Access	Default value / Description
iPar CRC	54	Read	0x00 ff. (empty)

Table 24: I&M 4 (Slot 2, Index 0xAFF4)

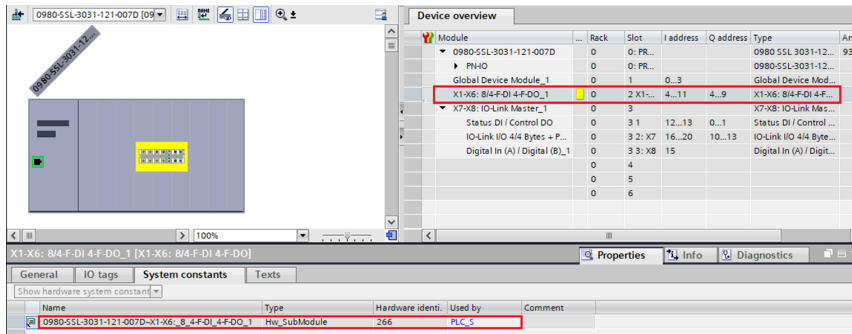

Figure 48: Hardware identifier of the Safety module for I&M 4 RDREC

8.9.1.3 I&M data of the IOL-Master proxy (Status/Control Module)

For reading I&M 0 data, the appropriate hardware identifier for *Slot 3 / Sub-slot 1* must be chosen:

The screenshot displays the Siemens TIA Portal interface. On the left, a rack diagram shows a module labeled '0980-55L-3031-12'. The main window shows the 'Device overview' table with the following data:

Module	Rack	Slot	I address	Q address	Type	Art...
0980-55L-3031-121-007D	0	0	PR...			0980 55L 3031-12...
PNNO	0	0	PR...			0980-55L-3031-12...
Global Device Module_1	0	1	0...3		Global Device Mod...	
X1-X6: 8/4-F-DI 4-F-DO_1	0	2	X1... 4...11	4...9	X1-X6: 8/4-F-DI 4-F...	
X7-X8: IO-Link Master_1	0	3			X7-X8: IO-Link Mas...	
Status DI / Control DO	0	3	1	12...13	0...1	Status DI / Control ...
IO-Link IIO 4/4 Bytes + P...	0	3	2: X7	16...20	10...13	IO-Link IIO 4/4 Byte...
Digital In (A) / Digital (B)_1	0	3	3: X8	15		Digital In (A) / Digit...
	0	4				
	0	5				
	0	6				

The 'Properties' window for the selected module shows the following information:

Name	Type	Hardware identi.	Used by	Comment
0980-55L-3031-121-007D-X7-X8: IO-Link Master_1...	Hw_SubModule	268	PLC_5	

Figure 49: Hardware identifier of the Status/Control Module for RDREC (Slot 3 / Sub-slot 1)

Data object	Length [byte]	Access	Default value / Description
MANUFACTURER_ID	2	Read	0x016A (Belden Deutschland GmbH)
ORDER_ID	20	Read	Order number of module in ASCII
SERIAL_NUMBER	16	Read	Defined in production process in ASCII
HARDWARE_REVISION	2	Read	Hardware revision of device
SOFTWARE_REVISION	4	Read	Software revision of device
REVISION_COUNTER	2	Read	Incremented for every statically stored parameter change on IO-Link Master (e.g., device name or IP address)
PROFILE_ID	2	Read	0x4E01 (IOL-Master proxy)
PROFILE_SPECIFIC_TYPE	2	Read	0x0000 (unspecified)
IM_VERSION	2	Read	0x0101 (I&M Version 1.1)
IM_SUPPORTED	2	Read	0x0000

Table 25: I&M 0 (Slot 3 / Sub-slot 1, Index 0xAFF0)

8.9.1.4 I&M data of the IOL-Device proxy

The IO-Link Device-specific I&M 0 and I&M 5 data can be read via *slot 3* and the appropriate *sub-slot (3.2/Port X7 .. 3.3/Port X8)*. The specified index is used for mapping the data sets. Only data not equal to zero are received if a connection to an IO-Link Device can be established.

The screenshot displays the Siemens TIA Portal interface. On the left, a rack diagram shows a module in Slot 3, sub-slot 2, highlighted in yellow. The 'Device overview' table on the right lists the following modules:

Module	Rack	Slot	I address	Q address	Type	Art...
0980-55L-3031-121-007D	0	0: PR...			0980 55L 3031-12...	93...
PIHO	0	0: PR...			0980-55L-3031-12...	
Global Device Module_1	0	1	0...3		Global Device Mod...	
X1-X6: 8/4-F-DI 4-F-DO_1	0	2 X1...	4...11	4...9	X1-X6: 8/4-F-DI 4-F...	
X7-X8: IO-Link_Mester_1	0	3			X7-X8: IO-Link Mas...	
Status DI / Control DO	0	3: 1	12...13	0...1	Status DI / Control ...	
IO-Link I/O 4/4 Bytes + P...	0	3: 2: X7	16...20	10...13	IO-Link I/O 4/4 Byte...	
Digital In (A) / Digital (B)_1	0	3: 3: X8	15		Digital In (A) / Digit...	
	0	4				
	0	5				
	0	6				

The 'IO-Link I/O 4/4 Bytes + P...' module is highlighted with a red box. Below the table, the 'Properties' dialog is open, showing the hardware identifier '0980-55L-3031-121-007D-X7-X8: IO-Link_Mester_1...' and the hardware identifier '272'.

Figure 50: Hardware identifier of the IO-Link port module (Slot 3 / sub-slot 2 .. 3)

I&M0 data	Octets	Data type	Mapping rules
VendorID	2	Unsigned16	IO-Link Direct parameter page 1: VendorID. Direct mapping, for example "0x136". Exceptions: 1 → 93; 26 → 257; 87 → 467.
OrderID	20	Visible String	"Product Name" or "DeviceID".
IM_Serial_Number	16	Visible String	Insert SerialNumber of Device (IO-Link Index 21). If it is not available set to "Not accessible".
IM_Hardware_Revision	2	Unsigned8	Set to 0x0000 (Default value)
IM_Software_Revision	4	Char,3 x Unsigned8	Set to V0.0.0 (official release but not detectable)
IM_RevisonCounter	2	Unsigned16	Set to "0" (0x0000)
IM_Profile_ID	2	Unsigned16	IO-Link (API = 0x4E01)
IM_Profile_Specific_Type	2	Unsigned16	Set to "0" (0x0000)
IM_Version	2	2 x Unsigned8	Octet 1 (MSB): set to 0x01 Octet 2 (LSB): set to 0x01
IM_Supported	2	Unsigned16 (Bit Array)	Profile specific I&M: 0x0020 (Bit 0 for I&M0 is always "0")

Table 26: I&M 0 (Slot 3 / sub-slot 2 .. 3, Index 0xAFF0)

I&M5 data	Octets	Data type	Mapping rules
IM_Annotation	64	String (UTF8)	"IO-Link Devices"
IM_OrderID	64	Visible String	"Product Name" or "DeviceID".
IM_VendorID	2	Unsigned16	"VendorID"
IM_Serial_Number	16	Visible String	Insert SerialNumber of device (IO-Link Index 21). If it is not available, set to "Not accessible".
IM_Hardware_Revision	2	Unsigned8	Set to 0x0000 (default value)
IM_Software_Revision	4	Char,3 x Unsigned8	Set to V0.0.0 (official release but not detectable)

Table 27: I&M 5 (Slot 3 / sub-slot 2 .. 3, Index 0xAFF5)

8.9.2 Reading and writing I&M data

In its standard library, SIEMENS offers TIA Portal® system function modules that allow I&M data to be read and written. A data set contains a 6-byte *BlockHeader* and the I&M record.

The data requested on reading, or the data to be written thus only start after the existing header. For writing, the header content must additionally be taken into account. [Table 28: Data set with BlockHeader and I&M Record](#) on page 123 shows the structure of a data set.

- ▶ For reading I&M 0 .. 4, the RDREC block must be configured with `LEN = 6 Byte Block Header + I&M data length`.
- ▶ For reading I&M 5, the RDREC block must be configured with `LEN = 6 Byte Block Header + 8 Byte I&M + I&M data length`.

Data object	Length [byte]	Data type	Coding	Description
BlockType	2	Word	I&M 0: 0x0020 I&M 1: 0x0021 I&M 2: 0x0022 I&M 3: 0x0023 I&M 4: 0x0024 I&M 5: 0x0025	BlockHeader
BlockLength	2	Word	I&M 0: 0x0038 I&M 1: 0x0038 I&M 2: 0x0012 I&M 3: 0x0038 I&M 5: 0x0098	
BlockVersionHigh	1	Byte	0x01	
BlockVersionLow	1	Byte	0x00	
I&M Data	I&M 0: 54 I&M 1: 54 I&M 2: 16 I&M 3: 54 I&M 4: 54 I&M 5: 152	Byte		I&M Record

Table 28: Data set with BlockHeader and I&M Record

8.9.2.1 I&M Read Record

I&M data can be read via the standard RDREC (SFB52) function block in the Siemens PLC. The logical address of the slot/sub-slot (ID) and the I&M index (INDEX) must be used as handover parameters. The return parameters show the length of the I&M data received and a status or error message.

Read example I&M0 of PN-IO device:

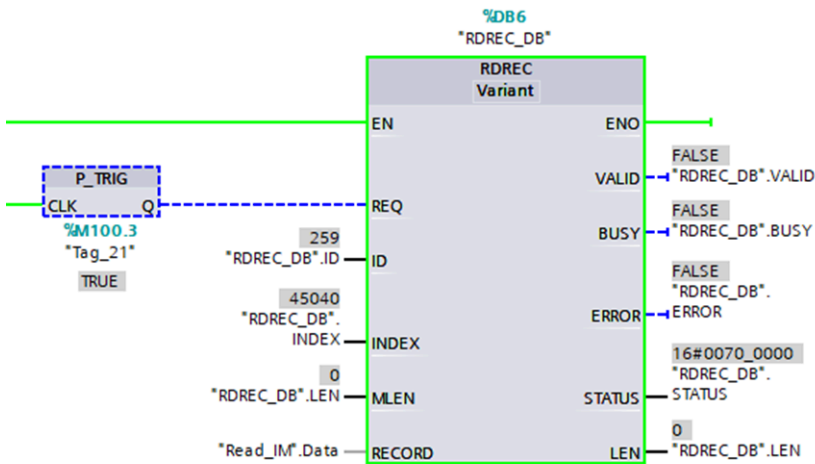

RDREC_DB					
	Name	Data type	Start value	Monitor value	Comment
1	Input				
2	REQ	Bool	false	FALSE	REQ = 1: Transfer data record
3	ID	HW_IO	259	259	HWId of the DP slave/PROFINET IO component
4	INDEX	DInt	16#AFFF	45040	Data record number
5	MLEN	UInt	16#FFFF	0	Maximum length in bytes of the data
6	Output				
7	VALID	Bool	false	FALSE	Function performed
8	BUSY	Bool	false	FALSE	Function busy
9	ERROR	Bool	false	FALSE	Error flag
10	STATUS	DWord	16#0	16#0070_0000	Function result/error message
11	LEN	UInt	0	0	Length of the fetched data record

Read data:

12	byte[0]	Byte	16#00	16#00	BlockType High: I&M0 = 0x0020
13	byte[1]	Byte	16#20	16#20	Block Type Low: I&M0 = 0x0020
14	byte[2]	Byte	16#00	16#00	BlockLength High: I&M0 = 0x0038
15	byte[3]	Byte	16#38	16#38	BlockLength Low: I&M0 = 0x0038
16	byte[4]	Byte	16#01	16#01	BlockVersion High: 1
17	byte[5]	Byte	16#0	16#00	BlockVersion Low: 0
18	byte[6]	Byte	16#0	16#01	Data: Vendor ID High of connected IOL-Device
19	byte[7]	Byte	16#0	16#6A	Data: Vendor ID Low of connected IOL-Device
20	byte[8]	Byte	16#0	16#39	Data: Order ID 1 (935 700 001)
21	byte[9]	Byte	16#0	16#33	Data: Order ID
22	byte[10]	Byte	16#0	16#35	Data: Order ID
23	byte[11]	Byte	16#0	16#20	Data: Order ID
24	byte[12]	Byte	16#0	16#37	Data: Order ID
25	byte[13]	Byte	16#0	16#30	Data: Order ID
26	byte[14]	Byte	16#0	16#30	Data: Order ID
27	byte[15]	Byte	16#0	16#20	Data: Order ID
28	byte[16]	Byte	16#0	16#30	Data: Order ID
29	byte[17]	Byte	16#0	16#30	Data: Order ID
30	byte[18]	Byte	16#0	16#31	Data: Order ID
31	byte[19]	Byte	16#0	16#20	Data: Order ID
32	byte[20]	Byte	16#0	16#20	Data: Order ID

Figure 51: Read example I&M0 of PN-IO device

Read example I&M0 on port X7 with connected IOL-Device:

RDREC_DB					
	Name	Data type	Start value	Monitor value	Comment
1	Input				
2	REQ	Bool	false	FALSE	REQ = 1: Transfer data record
3	ID	HW_IO	272	272	HWId of the DP slave/PROFINET IO component
4	INDEX	Dint	16#AFF0	45040	Data record number
5	MLEN	Uint	16#FFFF	0	Maximum length in bytes of the data
6	Output				
7	VALID	Bool	false	FALSE	Function performed
8	BUSY	Bool	false	FALSE	Function busy
9	ERROR	Bool	false	FALSE	Error flag
10	STATUS	DWord	16#0	16#0070_0000	Function result/error message
11	LEN	Uint	0	0	Length of the fetched data record

Read data:

2	[-] ▢	Data	Array[0..192] of Byte			
3	[-] ▢	Data[0]	Byte	16#0	16#00	BlockType High: I&M0 = 0x0020
4	[-] ▢	Data[1]	Byte	16#0	16#20	
5	[-] ▢	Data[2]	Byte	16#0	16#00	BlockLength High: I&M0 = 0x0038
6	[-] ▢	Data[3]	Byte	16#0	16#38	
7	[-] ▢	Data[4]	Byte	16#0	16#01	BlockVersion High: 1
8	[-] ▢	Data[5]	Byte	16#0	16#00	BlockVersion Low: 0
9	[-] ▢	Data[6]	Byte	16#0	16#01	Data: Vendor ID High
10	[-] ▢	Data[7]	Byte	16#0	16#6A	Data Vendor ID Low
11	[-] ▢	Data[8]	Byte	16#0	16#20	Data: Order ID
12	[-] ▢	Data[9]	Byte	16#0	16#20	Data: Order ID
13	[-] ▢	Data[10]	Byte	16#0	16#20	Data: Order ID
14	[-] ▢	Data[11]	Byte	16#0	16#20	Data: Order ID
15	[-] ▢	Data[12]	Byte	16#0	16#20	Data: Order ID
16	[-] ▢	Data[13]	Byte	16#0	16#20	Data: Order ID
17	[-] ▢	Data[14]	Byte	16#0	16#20	Data: Order ID
18	[-] ▢	Data[15]	Byte	16#0	16#20	Data: Order ID
19	[-] ▢	Data[16]	Byte	16#0	16#20	Data: Order ID
20	[-] ▢	Data[17]	Byte	16#0	16#20	Data: Order ID
21	[-] ▢	Data[18]	Byte	16#0	16#20	Data: Order ID
22	[-] ▢	Data[19]	Byte	16#0	16#20	Data: Order ID
23	[-] ▢	Data[20]	Byte	16#0	16#20	Data: Order ID
24	[-] ▢	Data[21]	Byte	16#0	16#20	Data: Order ID
25	[-] ▢	Data[22]	Byte	16#0	16#20	Data: Order ID

Figure 52: Read example I&M0 on port X7 with connected IOL-Device

Read example I&M5 on port X7 with connected IOL-Device:

RDREC_DB					
	Name	Data type	Start value	Monitor value	Comment
1	[-] ▢	Input			
2	[-] ▢	REQ	bool	FALSE	REQ = 1: Transfer data record
3	[-] ▢	ID	HW_IO	272	HWHd of the DP slave/PROFINET IO component
4	[-] ▢	INDEX	Dint	16#AFF5	Data record number
5	[-] ▢	MLEN	Uint	16#FFFF	0 Maximum length in bytes of the data
6	[-] ▢	Output			
7	[-] ▢	VALID	Bool	false	FALSE Function performed
8	[-] ▢	BUSY	Bool	false	FALSE Function busy
9	[-] ▢	ERROR	Bool	false	FALSE Error flag
10	[-] ▢	STATUS	DWord	16#0	16#0070_0000 Function result/error message
11	[-] ▢	LEN	Uint	0	0 Length of the fetched data record

Read data:

12	byte[0]	Byte	16#00	16#00	16#00		BlockType High: I&M5 = 0x0025
13	byte[1]	Byte	16#0	16#25	16#25		BlockType Low: I&M5 = 0x0025
14	byte[2]	Byte	16#00	16#00	16#00		BlockLength High: I&M = 0x00A2
15	byte[3]	Byte	16#0	16#A2	16#A2		BlockLength Low: I&M5 = 0x00A2 (162 dez)
16	byte[4]	Byte	16#0	16#01	16#01		BlockVersion High: 1
17	byte[5]	Byte	16#0	16#00	16#00		BlockVersion Low: 0
18	byte[6]	Byte	16#0	16#00	16#00		NumberOfEntries High
19	byte[7]	Byte	16#0	16#01	16#01		NumberOfEntries Low
20	byte[8]	Byte	16#0	16#00	16#00		BlockType Low I&M5 Data
21	byte[9]	Byte	16#0	16#34	16#34		BlockType High I&M5 Data
22	byte[10]	Byte	16#0	16#00	16#00		BlockLength Low I&M5 Data = 0x009A
23	byte[11]	Byte	16#0	16#9A	16#9A		BlockLength Low I&M5 Data = 0x009A (154 dez)
24	byte[12]	Byte	16#0	16#01	16#01		BlockVersion High: 1
25	byte[13]	Byte	16#0	16#00	16#00		BlockVersion Low: 0
26	byte[14]	Byte	16#0	16#49	16#49		IM Annotation "IO-Link Devices"
27	byte[15]	Byte	16#0	16#4F	16#4F		
28	byte[16]	Byte	16#0	16#2D	16#2D		
29	byte[17]	Byte	16#0	16#4C	16#4C		
30	byte[18]	Byte	16#0	16#69	16#69		
31	byte[19]	Byte	16#0	16#6E	16#6E		
32	byte[20]	Byte	16#0	16#6B	16#6B		
33	byte[21]	Byte	16#0	16#14	16#20		
34	byte[22]	Byte	16#0	16#44	16#44		

Figure 53: Read example I&M5 on port X7 with connected IOL-Device

8.9.2.2 I&M Write Record

I&M data can be written via the standard WRREC (SFB53) function block in the Siemens PLC. The logical address of the slot/sub-slot (ID), the I&M index (INDEX) and the data length (LEN) must be used as handover parameters. The return parameters contain a status or error message.

Write example I&M1 of PN-IO device:

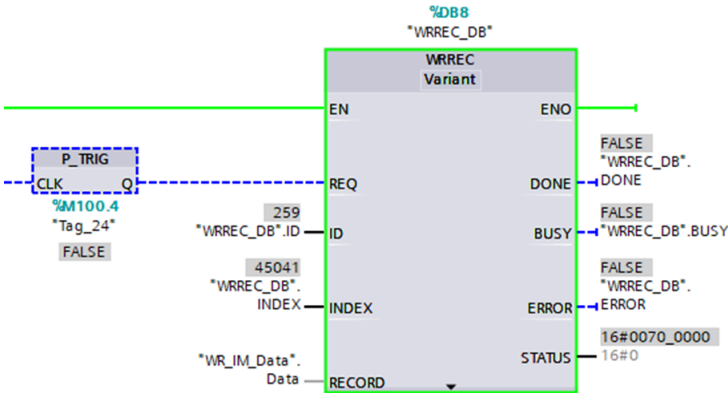

WRREC_DB					
	Name	Data type	Start value	Monitor value	Comment
1	Input				
2	REQ	Bool	true	FALSE	REQ = 1: Transfer data record
3	ID	HW_IO	259	259	HWId of the DP slave/PROFINETIO component
4	INDEX	Dint	16#AFF1	45041	Data record number
5	LEN	UInt	0	0	Maximum length in bytes of the data

Write data:

WR_IM_Data					
	Name	Data type	Start value	Monitor value	Comment
1	Static				
2	Data	Array[0..59] of Byte			
3	Data[0]	Byte	16#00	16#00	BlockType High: I&M1 = 0x0021
4	Data[1]	Byte	16#21	16#21	
5	Data[2]	Byte	16#00	16#00	BlockLength High: 0 for I&M1
6	Data[3]	Byte	16#38	16#38	BlockLength Low: 0x38 for I&M1
7	Data[4]	Byte	16#01	16#01	BlockVersion High: 1
8	Data[5]	Byte	16#00	16#00	BlockVersion Low: 0
9	Data[6]	Byte	16#61	16#61	Data: 'a'
10	Data[7]	Byte	16#62	16#62	Data: 'b'
11	Data[8]	Byte	16#63	16#63	Data: 'c'
12	Data[9]	Byte	16#64	16#64	Data: 'd'

Figure 54: Write example I&M1 of PN-IO device

8.10 Fast Start Up (FSU) / Prioritized Startup

Devices with Fast Start-Up (FSU) support an optimized system start-up. This leads to a faster restart after the power supply is restored.

Fast Start-Up can be activated via **PROFINET interface [X1] > Advanced options > Interface options** with the option *Prioritized start-up*.

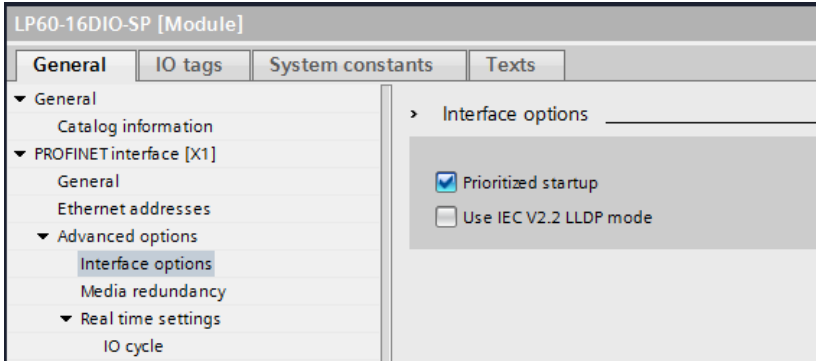

For better FSU performance, the transmission settings of ports X01 and X02 should be set to:

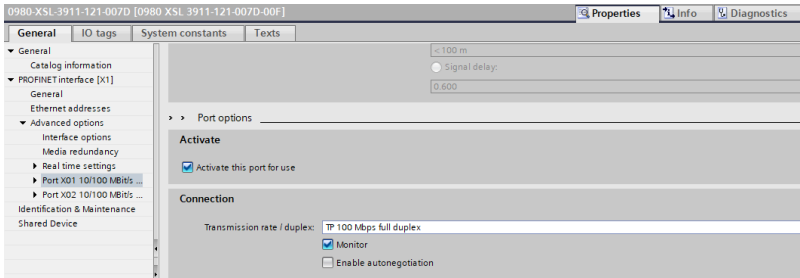

Attention: The settings for the local and the partner port must be identical.

Measured boot times

PROFINET FSU time:¹⁾

< 500 ms

Start time **with/without** FSU activated (for 0980 SSL-3031... and non-safe DIO on 2-port IO-Link Master slot):²⁾

~11500 ms

Start time **with/without** FSU activated (for 0980 SSL-3031... and functional safety DIO):³⁾

~11500 ms

1) Measured according to specification: Internal switch is able to forward telegrams.

2) The PLC reads one non-safe digital input and sets – in dependency of the input value – one non-safe digital output on the 2-port IO-Link Master slot after power-up of the DUT. The PLC is connected directly to DUT port X01 without any additional switch between PLC and DUT.

3) The PLC reads one functional safety digital input and sets – in dependency of the input value – one functional digital output after power-up of the DUT. The PLC is connected directly to DUT port X01 without any additional switch between PLC and DUT.

8.11 Suspend / Resume of IO-Link port operation

8.11.1 Automatic tool changer application use case

Depending on the state of a production process, a tool change inside of a machine is required by undocking a particular tool, for example a gripper, in a magazine and docking another one. This docking and undocking comprise mechanical joint and electrical connections for power supply as well as for communication.

With the following WRREC/RDREC calls

- ▶ Suspend port operation
- ▶ Resume port operation

the IO-Link port operation can be changed dynamically during the cyclic data exchange.

8.11.2 Concept

The basic concept of the user function "Suspend Port operation" is to suppress the entire PROFINET fault indications to the system/user, since it concerns an intended action. In essence, after the suspension all pending diagnosis messages of the related Port and device are deleted.

The current Port status is always visible to the user via the flag bit "PortActive" in the "Port Qualifier Information – PQI". Three activities characterize the port operations:

- ▶ Automatic Port operation
- ▶ Suspend Port operation
- ▶ Resume Port operation

Automatic Port operation

The following activities will turn a port automatically into state "Port operation resumed", indicated by flag bit "PortActive" = 1:

- ▶ Power-on of the IO-Link Device or Master
- ▶ Configuration change of the IOL-Master port

- ▶ Port configuration mode set to Digital Input or Digital Output

Suspend/Resume Port operation

Figure 55: Suspend/Resume Port operation on page 133 provides an overview of the mechanisms and serves as visualization of the following actions:

- ▶ Successfully suspended Port operation leads to flag bit indication "PortActive" = 0 and "DevErr" = 0.
- ▶ Undocking of the Tool/Device leads to flag bits "PQ" = 0 and "DevCom" = 0
- ▶ Docking of a "new" Tool/Device leads to flag bits "PQ" = 1 and "DevCom" = 1
- ▶ Successfully resumed Port operation leads to flag bit indication "PortActive" = 1

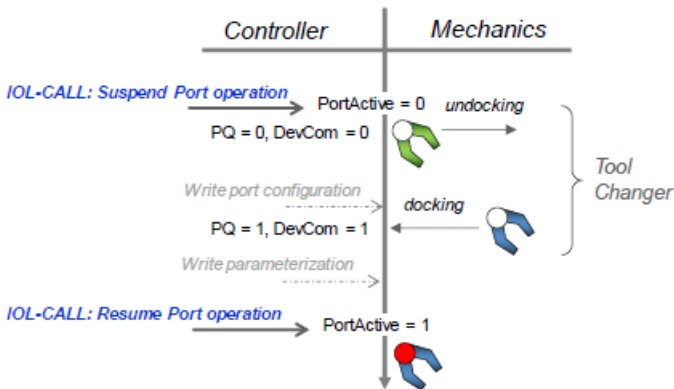

Figure 55: Suspend/Resume Port operation

8.11.3 Use cases

Use case	Inspection level (Backup & Restore)	Description
No. 1: A Device will be replaced by a Device of the same type with identical parameters.	0: no Device check 1: type compatible Device (V1.0) 2: type compatible Device (V1.1) 3: type compatible Device (V1.1) with Backup + Restore 4: type compatible Device (V1.1) with Restore	All Inspection Levels are permitted in use case No. 1. Recommended: type compatible Device V1.1 with Backup + Restore
No. 2: A Device will be replaced by a Device of the same type with different parameters.	0: no device check 1: type compatible Device (V1.0) 2: type compatible Device (V1.1)	Backup and Restore not reasonable in use case No. 2. Recommended: type compatible Device (V1.0 or V1.1)
No. 3: A Device will be replaced by a Device of a different type.	0: no Device check 1: type compatible Device (V1.0) 2: type compatible Device (V1.1)	Backup and Restore not reasonable in use case No. 3. Recommended: type compatible Device (V1.0 or V1.1)

- ▶ Port configuration can be adapted while in state "Port operation suspended" (use case no. 3).
- ▶ Additionally, the parameterization of the Device can be adapted after active Communication (DevCom =1) through control program (use case no. 2).
- ▶ Especially in use case no. 2 and no. 3 it is recommended to deactivate the Backup & Restore function for a better transparency and start-up performance.

8.11.4 Suspend and Resume cycle

For a complete Suspend and Resume cycle the following read and write requests must be performed step by step.

After writing the commands Suspend or Resume, the successful execution of the command must be verified by the appropriate read request.

8.11.4.1 Write Record Suspend – port command

The following example illustrates how to suspend an IO-Link port operation with the TIA WRREC function block:

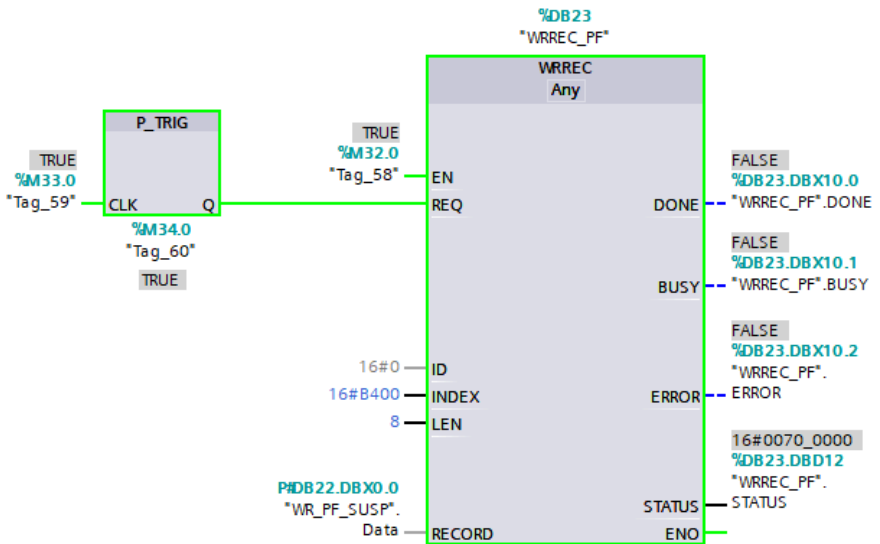

ID = 0 for addressing the IO-Link Master proxy

INDEX = 0xB400

LEN = 8 Bytes for command

	Name	Data type	Offset	Start value	Comment
1	Static				
2	Data	Array[0..59] of Byte	0.0		
3	Data[0]	Byte	0.0	16#8	Call Header
4	Data[1]	Byte	1.0	16#1	Port Number (1... 8)
5	Data[2]	Byte	2.0	16#FE	Call Fixed
6	Data[3]	Byte	3.0	16#4A	Call Fixed
7	Data[4]	Byte	4.0	16#02	Call Write
8	Data[5]	Byte	5.0	16#FF	Index Port Command
9	Data[6]	Byte	6.0	16#FF	Index Port Command
10	Data[7]	Byte	7.0	16#3	Command Suspend

Figure 56: WRREC data

8.11.4.2 Read Record Suspend – port status

Use this read request to verify that the previous writing of the suspend port command has been performed successfully.

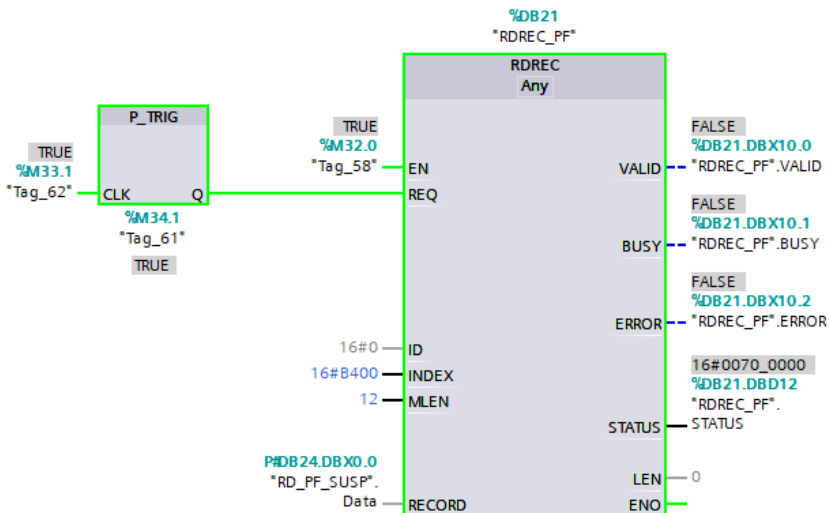

ID = 0 for addressing the IO-Link Master proxy

INDEX = 0xB400

LEN = 12 bytes, 8 bytes for command + 4 bytes for error PDU

If the suspend port command has been performed successfully, the read data look the following:

	Name	Data type	Offset	Start value	Monitor value	Comment
1	Static					
2	Data	Array[0..11] of Byte	0.0			
3	Data[0]	Byte	0.0	16#0	16#08	Call Header
4	Data[1]	Byte	1.0	16#0	16#01	Port Number (1..8)
5	Data[2]	Byte	2.0	16#0	16#FE	Call Fixed
6	Data[3]	Byte	3.0	16#0	16#4A	Call Fixed
7	Data[4]	Byte	4.0	16#0	16#00	Status 0x00 = OK, 0x80 = Error PDU
8	Data[5]	Byte	5.0	16#0	16#FF	Index Port Command
9	Data[6]	Byte	6.0	16#0	16#FF	Index Port Command
10	Data[7]	Byte	7.0	16#0	16#03	Command Suspend
11	Data[8]	Byte	8.0	16#0	16#00	Error PDU
12	Data[9]	Byte	9.0	16#0	16#00	Error PDU
13	Data[10]	Byte	10.0	16#0	16#00	SMI Job Error
14	Data[11]	Byte	11.0	16#0	16#00	SMI Job Error

The IO-Link Device can be disconnected now.

If the suspend process has not been finished on the IO-Link Master before the read record is received, a negative PROFINET response will be sent with the code "Resource busy – 0x80C2".

Possible error PDU codes:

NO_ERROR	0x0000
IOL_CALL_CONFLICT	0x7000
INCORRECT_IOL_CALL	0x7001
PORT_BLOCKED	0x7002
TIMEOUT	0x8000
INVALID_PORT_NUMBER	0x8001
INVALID_IOL_INDEX	0x8002
INVALID_IOL_SUBINDEX	0x8003
NO_DEVICE	0x8004
DECODE_ERROR	0x8051
RDREC_FAULT	0x8052
WREC_FAULT	0x8053
UNEXPECTED_ERROR_SEQ	0x8054

Possible error PDU codes:

FUNCTION_ERROR	0x8055
FUNCTION_NOT_AVAILABLE	0x8056
FUNCTION_NOT_SUPPORTED	0x8057

8.11.4.3 Write Record Resume – port command

The following example illustrates how to resume an IO-Link port operation with the TIA WRREC function block (after the IO-Link Device has been connected successfully):

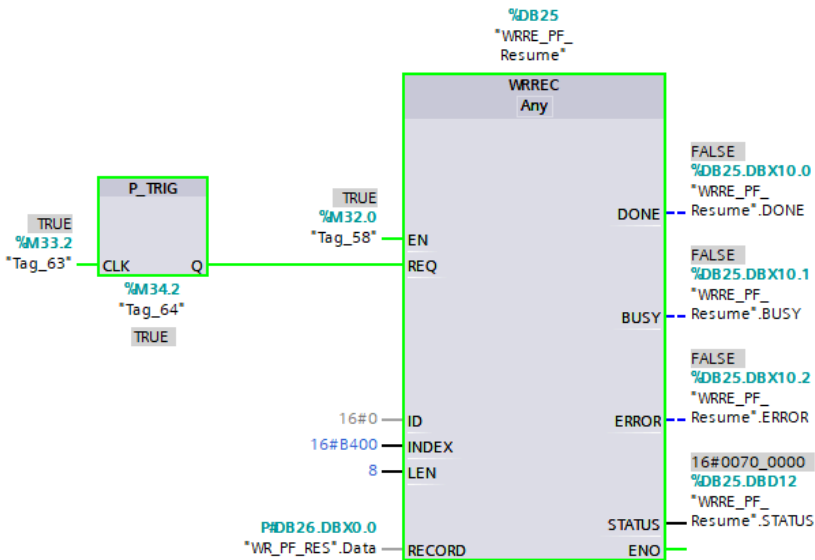

	Name	Data type	Offset	Start value	Comment
1	Static				
2	Data	Array[0..31] of Byte	0.0		
3	Data[0]	Byte	0.0	16#8	Call Header
4	Data[1]	Byte	1.0	16#1	Port Number (1...8)
5	Data[2]	Byte	2.0	16#FE	Call Fixed
6	Data[3]	Byte	3.0	16#4A	Call Fixed
7	Data[4]	Byte	4.0	16#02	Call Write
8	Data[5]	Byte	5.0	16#FF	Index Port Command
9	Data[6]	Byte	6.0	16#FF	Index Port Command
10	Data[7]	Byte	7.0	16#4	Command Resume = 0x04

Figure 57: WRREC data

8.11.4.4 Read Record Resume – port status

Use this read request to verify that the previous writing of the resume port command has been performed successfully.

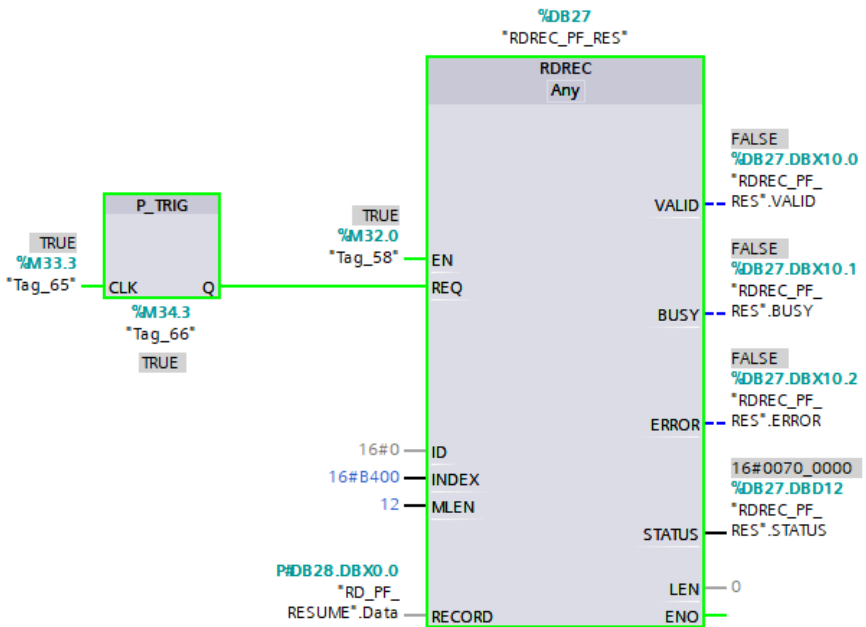

ID = 0 for addressing the IO-Link Master proxy

INDEX = 0xB400

LEN = 12 bytes, 8 bytes for command + 4 bytes for error PDU

If the resume port command has been performed successfully, the read data look the following:

	Name	Data type	Offset	Start value	Monitor value	Comment
1	Static					
2	Data	Array[0..231] of Byte	0.0			
3	Data[0]	Byte	0.0	16#0	16#08	Call Header
4	Data[1]	Byte	1.0	16#0	16#01	Port Number (1..8)
5	Data[2]	Byte	2.0	16#0	16#FE	Call Fixed
6	Data[3]	Byte	3.0	16#0	16#4A	Call Fixed
7	Data[4]	Byte	4.0	16#0	16#00	Status: 0x00=OK, 0x80 = Error PDU
8	Data[5]	Byte	5.0	16#0	16#FF	Index Port Command
9	Data[6]	Byte	6.0	16#0	16#FF	Index Port Command
10	Data[7]	Byte	7.0	16#0	16#04	Command Resume
11	Data[8]	Byte	8.0	16#0	16#00	Error PDU
12	Data[9]	Byte	9.0	16#0	16#00	Error PDU
13	Data[10]	Byte	10.0	16#0	16#00	SM Job Error
14	Data[11]	Byte	11.0	16#0	16#00	SM Job Error

If the resume process has not been finished on the IO-Link Master before the read record is received, a negative PROFINET response will be sent with the code "Resource busy – 0x80C2".

Possible error PDU codes:

NO_ERROR	0x0000
IOL_CALL_CONFLICT	0x7000
INCORRECT_IOL_CALL	0x7001
PORT_BLOCKED	0x7002
TIMEOUT	0x8000
INVALID_PORT_NUMBER	0x8001
INVALID_IOL_INDEX	0x8002
INVALID_IOL_SUBINDEX	0x8003
NO_DEVICE	0x8004
DECODE_ERROR	0x8051



Figure 59: Acknowledge Re-Integration for dedicated Safety I/O

9 Process data assignment

This chapter describes the process data assignment for the different slots of the device.

Key

X1A = Port 1, Channel A

Byte 0 = low address byte in a Siemens PLC

Byte 1 = high address byte in a Siemens PLC (applicable for a Siemens PLC using Big-Endian format)

9.1 Process data Global Device Module

Digital Input status of Slot 2 (Safety I/O) inputs when configured in non-Safe mode.

9.1.1 Mode 1

For module 0980 SSL 3031-121-007D, only X1 .. X4 are used.

I/O	Global Device Module	Bit 7	Bit 6	Bit 5	Bit 4	Bit 3	Bit 2	Bit 1	Bit 0
Slot 1	Byte 0	X4B	X4A	X3B	X3A	X2B	X2A	X1B	X1A
	Byte 1	X8B	X8A	X7B	X7A	X6B	X6A	X5B	X5A

Table 29: Digital input status for Mapping Mode 1

I/O	Global Device Module	Bit 7	Bit 6	Bit 5	Bit 4	Bit 3	Bit 2	Bit 1	Bit 0
Slot 1	Byte 2	X4B	X4A	X3B	X3A	X2B	X2A	X1B	X1A
	Byte 3	X8B	X8A	X7B	X7A	X6B	X6A	X5B	X5A

Table 30: Digital input qualifier for Mapping Mode 1

9.1.2 Mode 2

For module 0980 SSL 3031-121-007D, only X1 .. X4 are used.

I/O	Global Device Module	Bit 7	Bit 6	Bit 5	Bit 4	Bit 3	Bit 2	Bit 1	Bit 0
Slot 1	Byte 0	X8A	X7A	X6A	X5A	X4A	X3A	X2A	X1A
	Byte 1	X8B	X7B	X6B	X5B	X4B	X3B	X2B	X1B

Table 31: Digital input status for Mapping Mode 2

I/O	Global Device Module	Bit 7	Bit 6	Bit 5	Bit 4	Bit 3	Bit 2	Bit 1	Bit 0
Slot 1	Byte 2	X8A	X7A	X6A	X5A	X4A	X3A	X2A	X1A
	Byte 3	X8B	X7B	X6B	X5B	X4B	X3B	X2B	X1B

Table 32: Digital input qualifier for Mapping Mode 2

9.2 Process data 16/8-F-DI

9.2.1 Digital input data in One Channel Mode

I/O	16/8-F-DI	Bit 7	Bit 6	Bit 5	Bit 4	Bit 3	Bit 2	Bit 1	Bit 0
Slot 2	Byte 0 Input Status	X4B	X4A	X3B	X3A	X2B	X2A	X1B	X1A
	Byte 1 Input Status	X8B	X8A	X7B	X7A	X6B	X6A	X5B	X5A
	Byte 2 Input Qualifier	X4B	X4A	X3B	X3A	X2B	X2A	X1B	X1A
	Byte 3 Input Qualifier	X8B	X8A	X7B	X7A	X6B	X6A	X5B	X5A
	Byte 4	Safety Trailer (Status)							
	Byte 5	Safety Trailer (CRC)							
	Byte 6	Safety Trailer (CRC)							
	Byte 7	Safety Trailer (CRC)							
	Byte 8	Safety Trailer (CRC)							

Table 33: Digital input data in One Channel Mode

The Input Qualifier marks the input status data as valid with a '1'.

9.2.2 Digital input data in Two Channel Mode

I/O	16/8-F-DI	Bit 7	Bit 6	Bit 5	Bit 4	Bit 3	Bit 2	Bit 1	Bit 0	
Slot 2	Byte 0 Input Status	(X4A) 	X4A	(X3A) 	X3A	(X2A) 	X2A	(X1A) 	X1A	
	Byte 1 Input Status	(X8A) 	X8A	(X7A) 	X7A	(X6A) 	X6A	(X5A) 	X5A	
	Byte 2 Input Qualifier	(X4A) 	X4A	(X3A) 	X3A	(X2A) 	X2A	(X1A) 	X1A	
	Byte 3 Input Qualifier	(X8A) 	X8A	(X7A) 	X7A	(X6A) 	X6A	(X5A) 	X5A	
	Byte 4	Safety Trailer (Status)								
	Byte 5	Safety Trailer (CRC)								
	Byte 6	Safety Trailer (CRC)								
	Byte 7	Safety Trailer (CRC)								
	Byte 8	Safety Trailer (CRC)								

Table 34: Digital input data in Two Channel Mode



Attention: In *Two Channel Mode*, the Ch. A bits and Ch. B bits for each port are showing under error free conditions the same input combination result. Therefore, only the either unequal or equal bit numbers must be taken into consideration in the PLC for Input status and the Qualifier.

Exception in *Two Channel Mode*: After removing a "cross connection" fault on an F-DI port, the Qualifier is set to 'valid' although the Ch. A and Ch. B input bits can be unequal for one internal processor cycle.

Detailed status table for 'Two Channel Mode & Equivalence' settings:

Physical Input	LED A	LED B	Input Bits	Qualifier	PROFINET Diagnostic
			No.:	Bits No.:	
			1-0	1-0	
			3-2	3-2	
			5-4	5-4	
7-6	7-6				
Ch. A (Pin4) = 0V Ch. B (Pin2) = 0V	Off	Off	00	11	–
Ch. A (Pin4) = 24V Ch. B (Pin2) = 0V	Yellow & Red	Red	00	00	Discrepancy Error
Ch. A (Pin4) = 0V Ch. B (Pin2) = 24V	Red	White & Red	00	00	Discrepancy Error
Ch. A (Pin4) = 24V Ch. B (Pin2) = 24V	Yellow	White	11	11	–

Detailed status table for ‘Two Channel Mode & Antivalence’ settings:

(Channel A is the leading channel for a logical ‘1’ signal)

Physical Input	LED A	LED B	Input Bits	Qualifier	PROFINET Diagnostic
			No.:	Bits No.:	
			1-0	1-0	
			3-2	3-2	
			5-4	5-4	
7-6	7-6				
Ch. A (Pin4) = 0V Ch. B (Pin2) = 0V	Red	Red	00	00	Discrepancy Error
Ch. A (Pin4) = 24V Ch. B (Pin2) = 0V	Yellow	Off	11	11	–
Ch. A (Pin4) = 0V Ch. B (Pin2) = 24V	Off	White	00	11	–
Ch. A (Pin4) = 24V Ch. B (Pin2) = 24V	Yellow/ Red	White/Red	00	00	Discrepancy Error

9.3 Process data 8/4-F-DI, 4-F-DO

9.3.1 Digital input data in One Channel Mode

I/O	8/4-F-DI	Bit 7	Bit 6	Bit 5	Bit 4	Bit 3	Bit 2	Bit 1	Bit 0
Slot 2	Byte 0 Input Status	X4B	X4A	X3B	X3A	X2B	X2A	X1B	X1A
	Byte 1 Input Qualifier	X4B	X4A	X3B	X3A	X2B	X2A	X1B	X1A
	Byte 2 Output Qualifier	–	–	–	–	X6B	X6A	X5B	X5A
	Byte 3	Safety Trailer (Status)							
	Byte 4	Safety Trailer (CRC)							
	Byte 5	Safety Trailer (CRC)							
	Byte 6	Safety Trailer (CRC)							
	Byte 7	Safety Trailer (CRC)							

Table 35: Digital input data in One Channel Mode

9.3.2 Digital input data in Two Channel Mode 









I/O	8/4-F-DI	Bit 7	Bit 6	Bit 5	Bit 4	Bit 3	Bit 2	Bit 1	Bit 0
Slot 2	Byte 0 Input Status	(X4A) 	X4A	(X3A) 	X3A	(X2A) 	X2A	(X1A) 	X1A
	Byte 1 Input Qualifier	(X4A) 	X4A	(X3A) 	X3A	(X2A) 	X2A	(X1A) 	X1A
	Byte 2 Output Qualifier	–	–	–	–	X6B	X6A	X5B	X5A
	Byte 3	Safety Trailer (Status)							
	Byte 4	Safety Trailer (CRC)							
	Byte 5	Safety Trailer (CRC)							
	Byte 6	Safety Trailer (CRC)							
	Byte 7	Safety Trailer (CRC)							

Table 36: Digital input data in Two Channel Mode

Attention: In Two Channel Mode, the input combination result will be mapped to the Ch. A bit and mirrored to the Ch. B bit for each port. Additionally, the Qualifier shows in both port bits (Ch. A and Ch. B) the same information. Therefore, only the either unequal or equal bit numbers must be taken into consideration in the PLC for Input status and the Qualifier.

Detailed status table for 'Two Channel Mode & Equivalence' settings:

Physical Input	LED A	LED B	Input Bits	Qualifier	PROFINET Diagnostic
			No.:	Bits No.:	
			1-0	1-0	
			3-2	3-2	
			5-4	5-4	
7-6	7-6				
Ch. A (Pin4) = 0V Ch. B (Pin2) = 0V	Off	Off	00	11	–
Ch. A (Pin4) = 24V Ch. B (Pin2) = 0V	Yellow & Red	Red	00	00	Discrepancy Error
Ch. A (Pin4) = 0V Ch. B (Pin2) = 24V	Red	White & Red	00	00	Discrepancy Error
Ch. A (Pin4) = 24V Ch. B (Pin2) = 24V	Yellow	White	11	11	–

Detailed status table for 'Two Channel Mode & Antivalence' settings:

(Channel A is the leading channel for a logical '1' signal)

Physical Input	LED A	LED B	Input Bits	Qualifier	PROFINET Diagnostic
			No.:	Bits No.:	
			1-0	1-0	
			3-2	3-2	
			5-4	5-4	
7-6	7-6				
Ch. A (Pin4) = 0V Ch. B (Pin2) = 0V	Red	Red	00	00	Discrepancy Error
Ch. A (Pin4) = 24V Ch. B (Pin2) = 0V	Yellow	Off	11	11	–
Ch. A (Pin4) = 0V Ch. B (Pin2) = 24V	Off	White	00	11	–
Ch. A (Pin4) = 24V Ch. B (Pin2) = 24V	Yellow/ Red	White/Red	00	00	Discrepancy Error

9.3.3 Digital output data

I/O	4-F-DO	Bit 7	Bit 6	Bit 5	Bit 4	Bit 3	Bit 2	Bit 1	Bit 0
Slot 2	Byte 0 Output Control	–	–	–	–	X6B	X6A	X5B	X5A
	Byte 1	Safety Trailer (Control)							
	Byte 2	Safety Trailer (CRC)							
	Byte 3	Safety Trailer (CRC)							
	Byte 4	Safety Trailer (CRC)							
	Byte 5	Safety Trailer (CRC)							

Table 37: Digital output data

9.4 Process data Status DI/Control DO

The Status/Control Module has two bytes for digital input data and two bytes for digital output data on the IO-Link ports X7 and X8 in digital mode.

Status DI (digital input)

The two input bytes contain the status of the digital inputs. For the digital A channel inputs, the data are also available in the input byte of the appropriate sub-slot module.

Control DO (digital output)

The two output bytes contain the control bits for the digital outputs of the B channels.

For controlling the digital A channels, the output *Byte 1/Bit 0* of the appropriate sub-slot module must be used.

With the *General Device Settings* parameter *Digital Out Ch. A Controlled By: Status/Control Module*, the control can be switched to the *Control Bits*. In this case, the outputs cannot be controlled by the sub-slot output *Byte 1/Bit 0*.

The digital output can be controlled only by one data source.

Parameter Dependencies for Digital-I/O data mapping

Please refer to chapter [I/O mapping configuration of Status/Control data](#) on page 73 for the bit mapping settings.

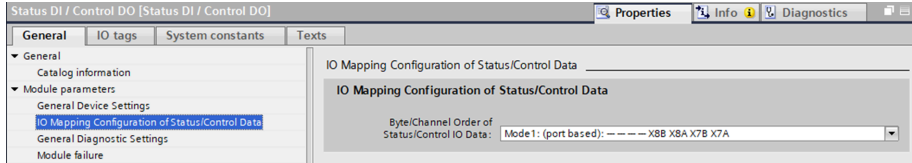

9.4.1 Status/Control data with assignment

For details on bit mapping configuration, see chapters [I/O mapping configuration of Status/Control data](#) on page 73 and [I/O port overview](#).

Key

X1A = Port X1, Channel A (Pin 4)

1st Byte = low address byte in a Siemens PLC

2nd Byte = high address byte in a Siemens PLC (applicable for a Siemens PLC using Big-Endian format)

9.4.1.1 Digital Input Mode 1

I/O	Status DI	Bit 7	Bit 6	Bit 5	Bit 4	Bit 3	Bit 2	Bit 1	Bit 0
Status/ Control Slot 3.1	Byte 0 Status	–	–	–	–	X8B	X8A	X7B	X7A
	Byte 1 Qualifier	–	–	–	–	X8B	X8A	X7B	X7A

Table 38: Digital Input Mapping Mode 1

9.4.1.2 Digital Output Mode 1

I/O	Control DO	Bit 7	Bit 6	Bit 5	Bit 4	Bit 3	Bit 2	Bit 1	Bit 0
Status/ Control Slot 3.1	Byte 0 Control	–	–	–	–	X8B	X8A	X7B	X7A
	Byte 1	–	–	–	–	–	–	–	–

Table 39: Digital Output Mapping Mode 1

9.4.1.3 Digital Input Mode 2

I/O	Status DI	Bit 7	Bit 6	Bit 5	Bit 4	Bit 3	Bit 2	Bit 1	Bit 0
Status/ Control Slot 3.1	Byte 1 Status	–	–	X8B	X7B	–	–	X8A	X7A
	Byte 2 Qualifier	–	–	X8B	X7B	–	–	X8A	X7A

*Table 40: Digital Input Mapping Mode 2***9.4.1.4 Digital Output Mode 2**

I/O	Control DO	Bit 7	Bit 6	Bit 5	Bit 4	Bit 3	Bit 2	Bit 1	Bit 0
Status/ Control Slot 3.1	Byte 1 Control	–	–	X8B	X7B	–	–	X8A	X7A
	Byte 2	–	–	–	–	–	–	–	–

Table 41: Digital Output Mapping Mode 2

9.5 Process data IO-Link ports, Slot 3.2 .. 3.3

The process data lengths of the IO-Link ports in COM mode depend on the IO-Link port configurations X7 .. X8. Data lengths between 0 .. 32 bytes of input data and/or 0 .. 31 bytes of output data are configurable.

The data content can be taken from the descriptions of the IO-Link Devices. If a precise data length is not available for the IO-Link configuration, always select the next larger data length.

The last byte of the port input data contains the PQI byte (Port Qualifier Information). This byte is added to the IOL-Device input data by the IOL-Master.

Ch. A configuration as Digital Input

If the Port is configured as digital input, the port data length is one byte and the digital input status will be set on bit 0. The digital input status will also be mapped to the status bytes of the Status/Control Module.

The mapping mode selected for the Status/Control Module has no influence on the process data of the IO-Link ports.

INPUT	Input	Bit 7	Bit 6	Bit 5	Bit 4	Bit 3	Bit 2	Bit 1	Bit 0
Slot 3.2	X7 Byte 0 .. 32	▶ If the IO-Link Port is in "Digital-In" Mode, the "DI-C/Q" state (Channel A, Pin 4) will be set in Bit 0 of Byte 0. In this case no PQI Byte is available. ▶ The last Byte contains the PQI (Port Qualifier Information).							
Slot 3.3	X8 Byte 0 .. 32								

Table 42: Input data: Sub-slots 3.2 .. 3.3

Bit	Acronym	Short Description	Value	Description
0	–	Reserved	0	Reserved
			–	–
1	–	Reserved	0	Reserved
			–	–
2	NewParam	New parameter	0	<i>Not supported yet, don't evaluate this bit!</i>
			1	<i>Not supported yet, don't evaluate this bit!</i>
3	SubstDev	Substitute Device detection	0	<i>Not supported yet, don't evaluate this bit!</i>
			1	<i>Not supported yet, don't evaluate this bit!</i>
4	PortActive	Port operation	0	port deactivated via port function
			1	port activated (default)
5	DevCom	Device communication	0	no IOL-Device available
			1	IOL-Device detected and is in PREOPERATE or OPERATE state
6	DevErr	Port/Device error indication	0	no error/warning occurred
			1	error/warning assigned to IOL-Device or IOL-Master port occurred
7	PQ	Device Process Data validity	0	invalid I/O process data from IOL-Device
			1	valid I/O process data from device

Table 43: PQI description

OUTPUT	Output	Bit 7	Bit 6	Bit 5	Bit 4	Bit 3	Bit 2	Bit 1	Bit 0
Slot 3.2	X7 Byte 0 .. 31	▶ optional / If IO-Link Port is in "Digital-Out" Mode, the "DO-C/Q" state (Channel A, Pin 4) will be set in Bit 0 of Byte 0.							
Slot 3.3	X8 Byte 0 .. 31								

Table 44: Output data: Sub-slots 3.2 .. 3.3

Ch. A configuration as Digital Output

If the Port is configured as digital output, the port data length is one byte (one byte with digital output control in bit 0).

If the *General device* parameter *Digital Out Ch. A Controlled by* is set to "Status/Control Module", the output cannot be controlled by bit 0 in the port output byte.

9.6 Process data mirrored Global Device Module

As described in chapter [Process data Global Device Module](#) on page 143.

9.7 Process data mirrored Safety Module

As described in chapters [Process data 16/8-F-DI](#) on page 145 and [Process data 8/4-F-DI, 4-F-DO](#) on page 148 without the 5-byte trailer attached to the input data.

9.7.1 16/8-F-DI

9.7.1.1 Digital input data in One Channel Mode

I/O	16/8-F-DI	Bit 7	Bit 6	Bit 5	Bit 4	Bit 3	Bit 2	Bit 1	Bit 0
Slot 4	Byte 0 Input Status	X4B	X4A	X3B	X3A	X2B	X2A	X1B	X1A
	Byte 1 Input Status	X8B	X8A	X7B	X7A	X6B	X6A	X5B	X5A
	Byte 2 Input Qualifier	X4B	X4A	X3B	X3A	X2B	X2A	X1B	X1A
	Byte 3 Input Qualifier	X8B	X8A	X7B	X7A	X6B	X6A	X5B	X5A

Table 45: Digital input data in One Channel Mode

The Input Qualifier marks the input status data as valid with a '1'.

9.7.1.2 Digital input data in Two Channel Mode

















I/O	16/8-F-DI	Bit 7	Bit 6	Bit 5	Bit 4	Bit 3	Bit 2	Bit 1	Bit 0
Slot 4	Byte 0 Input Status	(X4A) 	X4A	(X3A) 	X3A	(X2A) 	X2A	(X1A) 	X1A
	Byte 1 Input Status	(X8A) 	X8A	(X7A) 	X7A	(X6A) 	X6A	(X5A) 	X5A
	Byte 2 Input Qualifier	(X4A) 	X4A	(X3A) 	X3A	(X2A) 	X2A	(X1A) 	X1A
	Byte 3 Input Qualifier	(X8A) 	X8A	(X7A) 	X7A	(X6A) 	X6A	(X5A) 	X5A

Table 46: Digital input data in Two Channel Mode



Attention: In Two Channel Mode, the input combination result will be mapped to the Ch. A bit and mirrored to the Ch. B bit for each port. Additionally, the Qualifier shows the same information in both port bits (Ch. A and Ch. B). Therefore, only the either unequal or equal bit numbers must be taken into consideration in the PLC for Input status and the Qualifier.

9.7.2 8/4-F-DI

9.7.2.1 Digital input data in One Channel Mode

I/O	8/4-F-DI	Bit 7	Bit 6	Bit 5	Bit 4	Bit 3	Bit 2	Bit 1	Bit 0
Slot 5	Byte 0 Input Status	X4B	X4A	X3B	X3A	X2B	X2A	X1B	X1A
	Byte 1 Input Qualifier	X4B	X4A	X3B	X3A	X2B	X2A	X1B	X1A
	Byte 2 Output Control Status	–	–	–	–	X6B	X6A	X5B	X5A
	Byte 3 Output Qualifier	–	–	–	–	X6B	X6A	X5B	X5A

Table 47: Digital input data in One Channel Mode

9.7.2.2 Digital input data in Two Channel Mode









I/O	8/4-F-DI	Bit 7	Bit 6	Bit 5	Bit 4	Bit 3	Bit 2	Bit 1	Bit 0
Slot 5	Byte 0 Input Status	(X4A) 	X4A	(X3A) 	X3A	(X2A) 	X2A	(X1A) 	X1A
	Byte 1 Input Qualifier	(X4A) 	X4A	(X3A) 	X3A	(X2A) 	X2A	(X1A) 	X1A
	Byte 2 Output Control Status	–	–	–	–	X6B	X6A	X5B	X5A
	Byte 3 Output Qualifier	–	–	–	–	X6B	X6A	X5B	X5A

Table 48: Digital input data in Two Channel Mode



Attention: In Two Channel Mode, the input combination result will be mapped to the Ch. A bit and mirrored to the Ch. B bit for each port. Additionally, the Qualifier shows in both port bits (Ch. A and Ch. B) the same information. Therefore, only the either unequal or equal bit

numbers must be taken into consideration in the PLC for Input status and the Qualifier.

9.8 Process data mirrored IO-Link Master

As described in chapters [Process data Status DI/Control DO](#) on page 151 and [Process data IO-Link ports, Slot 3.2 .. 3.3](#) on page 155.

10 Functional Safety I/O modes

10.1 F-DI modes overview

The following Safety levels can be reached for the digital Functional Safety inputs of the modules 0980 SSL 3030-121-007D-101 and 0980 SSL 3031-121-007D-101. Refer to the referenced chapters in the table below for detailed information and the requirements for reaching the respective Safety level.

Up to Safety level	Configuration settings			
	Setting options	F-DI	Safety	Evaluation
SIL 2, PL d, Cat. 2 (with external test interval) on page 163	Setting 1	'Without Test Pulse for 1-Channel Mode/1oo1'	'Safe'	'No Evaluation (1-Channel/1oo1)'
	Setting 2	'Without Test Pulse for 2-Channel Mode/1oo2'	'Safe'	'Antivalence'
SIL 2, PL d, Cat. 2 on page 167	Setting 1	'With Test Pulse for 2-Channel Mode/1oo2'	'Safe'	'Antivalence'
	Setting 2	'With Test Pulse for 1-Channel Mode/1oo1'	'Safe'	'No Evaluation (1-Channel/1oo1)'
SIL 3, PL d, Cat. 3 (with external test interval) on page 171	–	'Without Test Pulse for 2-Channel Mode/1oo2'	'Safe'	'Equivalence'
SIL 3, PL e, Cat. 4 on page 173	–	'With Test Pulse for 2-Channel Mode/1oo2'	'Safe'	'Equivalence'

Table 49: F-DI modes

- For the SIL (Safety Integration Level) specification, refer to IEC 61508 Parts 1-7:2010.

- ▶ For the PL (Performance Level) and Cat. (Category), refer to EN ISO 13849-1:2015 / EN ISO 13849-1:2023.
- ▶ Refer also to chapter [Module parameters](#) on page 58 for parameter settings via the SIEMENS TIA Portal®.

10.1.1 SIL 2, PL d, Cat. 2 (with external test interval)

For reaching this functional safety level there are **two settings** possible.

For **Setting 1**, the following configuration must be set:

- ▶ Configuration F-DI Module (Option 1):
'Without Test Pulse for 1-Channel Mode/1oo1' – In this mode, the Pin1 and Pin5 sensor supplies of a digital input port will **not be switched off** for functional hardware tests.

Both input channels A and B can be used independently.
- ▶ Safety Configuration:
'Safe'
- ▶ Evaluation Configuration:
'No Evaluation (1-Channel/1oo1)'



Danger: In order to achieve PL d for the application, the machine control must carry out an average diagnostic measure. This can be achieved by testing the safety function inside the application by dynamically switching off the input signals and by checking this procedure based on the transmitted input status in the machine control. The diagnostic test interval must be less than the required response time or at least a 100 times the expected request rate of the application. Without this diagnostic test interval, only PL c will be reached.

With this configuration **no cross-fault detection** is provided!

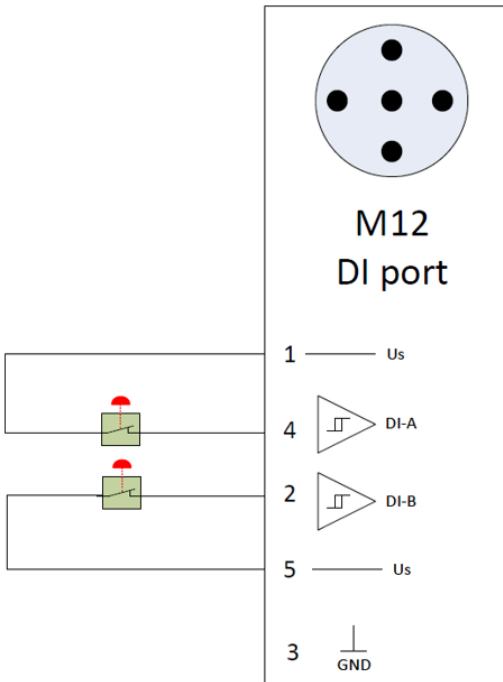

Figure 60: Internal F-DI block diagram

Module variant	Available channels in this mode
0980 SSL 3031-121-007D-101	up to 8
0980 SSL 3030-121-007D-101	up to 16

Table 50: Available channels

For **Setting 2**, the following configuration must be set:

► Configuration F-DI Module (Option 3B):

'Without Test Pulse for 2-Channel Mode/1oo2' – In this mode, the Pin1 and Pin5 sensor supplies of a digital input port will **not be switched off** for functional hardware tests.

Both physical input channels A and B will be used for one-bit information of the digital input represented in the channel A bit and mirrored in the channel B bit. Depending on the 'Antivalence' set in *Evaluation Configuration*, both input channels must have the opposite status for a valid input status on the channel A bit.

► Safety Configuration:

'Safe'

► Evaluation Configuration:

'Antivalence'



Danger: In order to achieve PL d for the application, the machine control must carry out an average diagnostic measure. This can be achieved by testing the safety function inside the application by dynamically switching off the input signals and by checking this procedure based on the transmitted input status in the machine control. The diagnostic test interval must be less than the required response time or at least a 100 times the expected request rate of the application. Without this diagnostic test interval, only PL c will be reached.

With this configuration **no cross-fault detection** is provided!

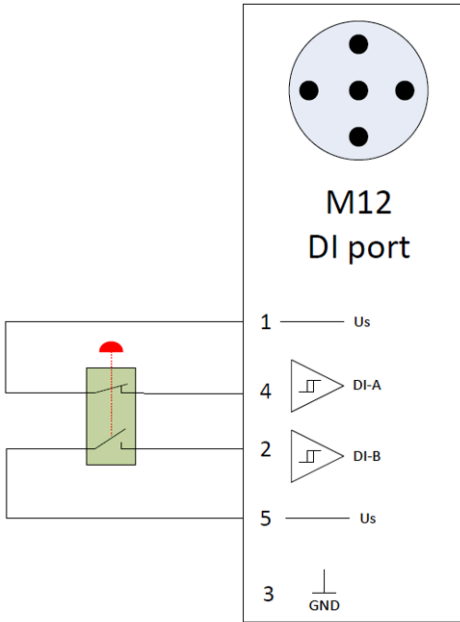

Figure 61: Internal F-DI block diagram

Module variant	Available channels in this mode
0980 SSL 3031-121-007D-101	up to 4
0980 SSL 3030-121-007D-101	up to 8

Table 51: Available channels

10.1.2 SIL 2, PL d, Cat. 2

For reaching this functional safety level there are **two settings** possible.

For **Setting 1**, the following configuration must be set:

► Configuration F-DI Module (Option 4B):

'With Test Pulse for 2-Channel Mode/1oo2' – In this mode, the Pin1 and Pin5 sensor supplies of a digital input port will be **switched off** for functional hardware tests.

Both physical input channels A and B will be used for one-bit information of the digital input represented in the channel A bit and mirrored in the channel B bit.

► Safety Configuration:

'Safe'

► Evaluation Configuration:

'Antivalence' – Both input channels must have the opposite status for a valid input status on the channel A bit.

The diagnostic test interval is 108 ms for module variant 0980 SSL 3x31-121... and 204 ms for module variant 0980 SSL 3x30-121... . The required response time must be equal or higher than T_D , or the expected request rate of the application must be at least a 100 times higher than T_D .

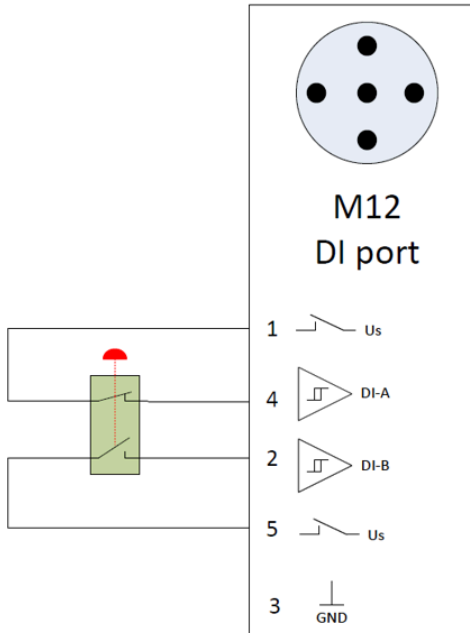

Figure 62: Internal F-DI block diagram

Module variant	Available channels in this mode
0980 SSL 3031-121-007D-101	up to 4
0980 SSL 3030-121-007D-101	up to 8

Table 52: Available channels

For **Setting 2**, the following configuration must be set:

► Configuration F-DI Module (Option 2):

'With Test Pulse for 1-Channel Mode/1oo1' – In this mode, the Pin1 and Pin5 sensor supplies of a digital input port will **be switched off** cyclically for functional hardware tests.

The diagnostic test interval is 108 ms for module variant 0980 SSL 3x31-121... and 204 ms for module variant 0980 SSL 3x30-121... . The required response time must be equal or higher than T_D , or the expected request rate of the application must be at least a 100 times higher than T_D .

Both input channels A and B can be used independently.

► Safety Configuration:

'Safe'

► Evaluation Configuration:

'No Evaluation (1-Channel/1oo1)'

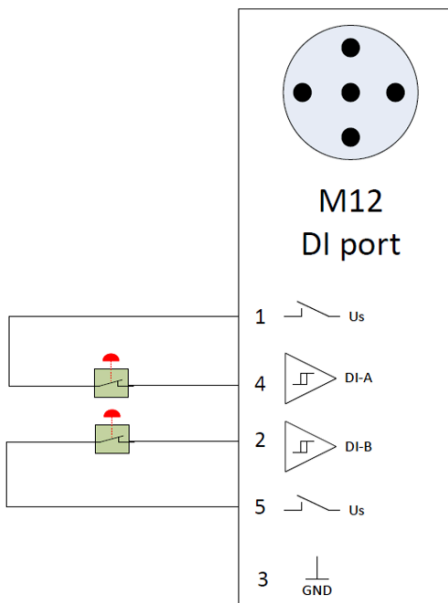

Figure 63: Internal F-DI block diagram

Module variant	Available channels in this mode
0980 SSL 3031-121-007D-101	up to 8
0980 SSL 3030-121-007D-101	up to 16

Table 53: Available channels

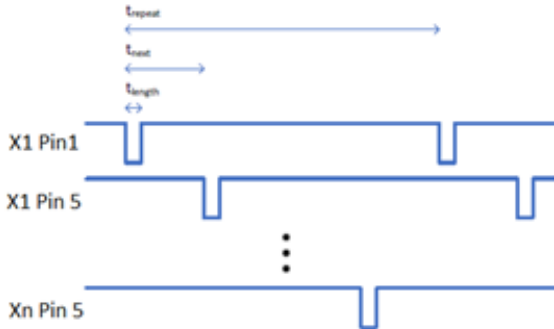

Figure 64: Diagramm: F-DI test pulse timing

$$t_{length} = 0.5 \text{ ms}$$

$$t_{next} = 12 \text{ ms}$$

$$t_{repeat} = 96 \text{ ms (0980 SSL3031-121-007D-101, } n = 8)$$

$$t_{repeat} = 192 \text{ ms (0980 SSL3030-121-007D-101, } n = 16)$$

10.1.3 SIL 3, PL d, Cat. 3 (with external test interval)

For reaching this functional safety level the following configuration must be set:

- ▶ Configuration F-DI Module (Option 3A):

'Without Test Pulse for 2-Channel Mode/1oo2' – In this mode, the Pin1 and Pin5 sensor supplies of a digital input port will **not be switched off** for functional hardware tests.

Both physical input channels A and B will be used for one-bit information of the digital input represented in the channel A bit and mirrored in the channel B bit. Depending on the 'Equivalence' set in *Evaluation Configuration*, both input channels must be equal for a valid input status on the channel A bit.

- ▶ Safety Configuration:

'Safe'

- ▶ Evaluation Configuration:

'Equivalence'



Danger: In order to achieve PL d for the application, the machine control must carry out an average diagnostic measure. This can be achieved by testing the safety function inside the application by dynamically switching off the input signals and by checking this procedure based on the transmitted input status in the machine control. The diagnostic test interval T_D must be $< \text{ or } = 24 \text{ h}$.

With this configuration **no cross-fault detection** is provided!

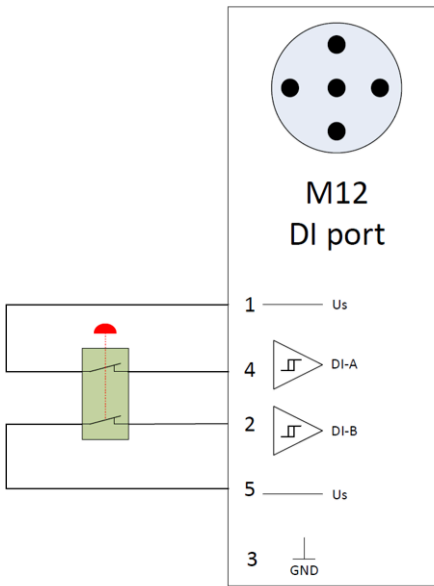

Figure 65: Internal F-DI block diagram

Module variant	Available channels in this mode
0980 SSL 3031-121-007D-101	up to 4
0980 SSL 3030-121-007D-101	up to 8

Table 54: Available channels

10.1.4 SIL 3, PL e, Cat. 4

For reaching this functional safety level the following configuration must be set:

▶ Configuration F-DI Module (Option 4A):

'With Test Pulse for 2-Channel Mode/1oo2' – In this mode, the Pin1 and Pin5 sensor supplies of a digital input port will **be switched off** for functional hardware tests.

Both physical input channels A and B will be used for one-bit information of the digital input represented in the channel A bit and mirrored in the channel B bit.

▶ Safety Configuration:

'Safe'

▶ Evaluation Configuration:

'Equivalence' – Both input channels must have the same status for a valid input status on the channel A bit.

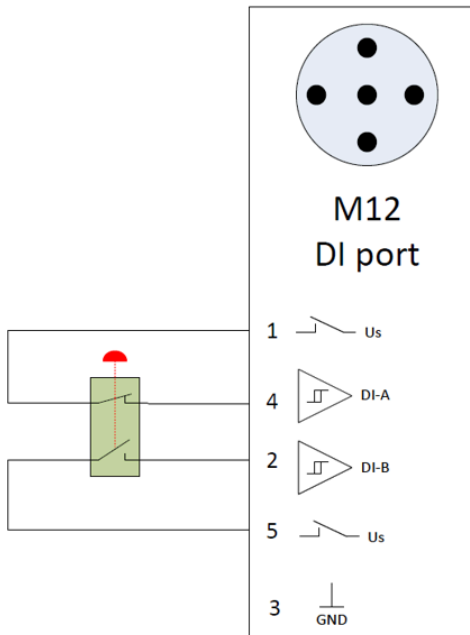

Figure 66: Internal F-DI block diagram

Module variant	Available channels in this mode
0980 SSL 3031-121-007D-101	up to 4
0980 SSL 3030-121-007D-101	up to 8

Table 55: Available channels

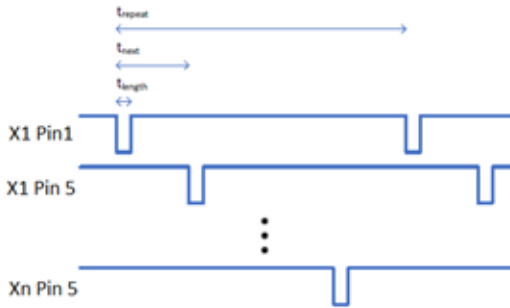

Figure 67: Diagramm: F-DI test pulse timing

$$t_{\text{length}} = 0.5 \text{ ms}$$

$$t_{\text{next}} = 12 \text{ ms}$$

$$t_{\text{repeat}} = 96 \text{ ms (0980 SSL3031-121-007D-101, n = 8)}$$

$$t_{\text{repeat}} = 192 \text{ ms (0980 SSL3030-121-007D-101, n = 16)}$$

10.2 F-DO modes overview

Only the module variant 0980 SSL3031-121-007D-101 provides digital Functional Safety outputs.

For the digital Functional Safety outputs, the mode to select depends on the wiring of the connected actuators.

Safety level	F-DO concept (1oo2)	GND UL testing	Chapter
SIL 3, PL e, Cat. 4	Two redundant F-DOs	Without	SIL 3, PL e, Cat. 4 with two redundant F-DOs on page 177
SIL 3, PL e, Cat. 4	Two redundant actuators	With	SIL 3, PL e, Cat. 4 with two redundant actuators on page 178

Table 56: F-DO modes

The following schematic illustration shows the internal safety relevant testing capabilities:

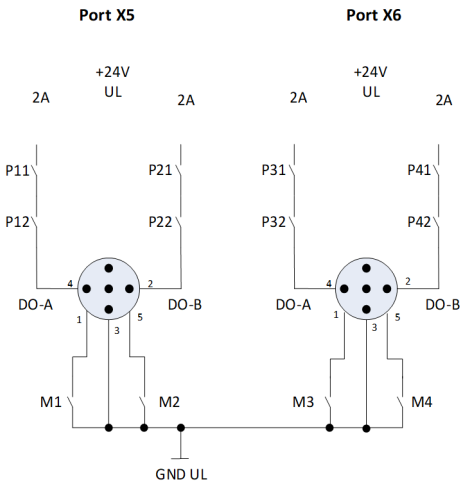

Figure 68: Schematic illustration of the DO functionality

The pulse width for the test switches must be configured in dependency of the used actuators. Refer to section **Test Pulse Configuration F-DO** in [Module parameters](#) on page 58 for test pulse configuration and the appropriate test pulse timing in dependency of the setting.

10.2.1 SIL 3, PL e, Cat. 4 with two redundant F-DOs

In this mode the Safety controller must control two outputs redundantly. The GND connection on Pin 3 must be used. There is no internal testing mechanism on the Pin 3 GND.

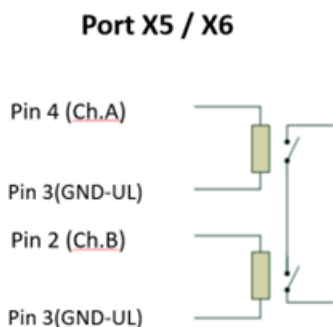

Figure 69: Schematic illustration with two redundant F-DOs

Module variant	Available channels in this mode
0980 SSL 3031-121-007D-101	up to 2

Table 57: Available channels in redundant outputs mode

10.2.2 SIL 3, PL e, Cat. 4 with two redundant actuators

In this mode two actuators must be used redundantly on one F-DO. The internal tested GND on Pin 1 for the F-DO channel A and Pin 5 for the F-DO channel B must be used in this mode.

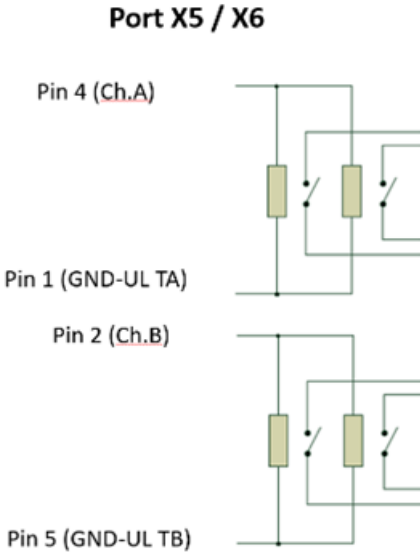

Figure 70: Schematic illustration with two redundant actuators

Module variant	Available channels in this mode
0980 SSL 3031-121-007D-101	up to 4

Table 58: Available channels in redundant actuators mode



Attention: If the switched UL_GND potential (DO_Nx) is disconnected in the event of a detected fault, the connected actuators must assume the safe state. It must be ensured that the actuators do not draw the UL_GND potential from another location.

11 PROFIsafe Configurator App

In [Parameterization of the Safety I/O module](#) on page 58 you find the description of how to start and work with the PROFIsafe Configurator Application within the SIEMENS TIA Portal®.

Alternatively, you can use the PROFIsafe Configurator App as a standalone App without starting it from SIEMENS TIA Portal®.

1. Install the Belden PROFIsafe Configurator App from <https://www.belden.com/products/i-o-systems>.
2. Start the App via the respective desktop symbol in case the TCI (Tool Calling Interface) is not supported by your engineering software.
3. Select the Device Description File as used in the engineering software project: **Module > Select Device Description File > ...**
4. Set the I/O module parameters exactly as set in the engineering software project, e.g.:

Inputs and Outputs Configuration For 8/4-F-DI 4-F-DO

Hardware Identifier : Configuration DI Module :

Safety Configuration X1A (Pin4) and X1B (Pin2):	<input type="text" value="Safe"/>
Safety Configuration X2A (Pin4) and X2B (Pin2):	<input type="text" value="Non Safe"/>
Safety Configuration X3A (Pin4) and X3B (Pin2):	<input type="text" value="Safe"/>
Safety Configuration X4A (Pin4) and X4B (Pin2):	<input type="text" value="Safe"/>
Evaluation Configuration X1A (Pin4) and X1B (Pin2):	<input type="text" value="Equivalence (2-Channel/1oo2), No Evaluation (1-Channel/1oo1)"/>
Evaluation Configuration X2A (Pin4) and X2B (Pin2):	<input type="text" value="Antivalence (2-Channel/1oo2)"/>
Evaluation Configuration X3A (Pin4) and X3B (Pin2):	<input type="text" value="Equivalence (2-Channel/1oo2), No Evaluation (1-Channel/1oo1)"/>
Evaluation Configuration X4A (Pin4) and X4B (Pin2):	<input type="text" value="Equivalence (2-Channel/1oo2), No Evaluation (1-Channel/1oo1)"/>
Test Pulse Configuration DO	<input type="text" value="Test Pulse Length 0.5ms and Repetition Rate ~100ms"/>

PLEASE CHECK ALL PARAMETER OF THE SAFETY MODULE!

 I have checked all parameter entries! Hex DecF_iPar_CRC :

GSDMLV2.41-BeldenDeutschland-LioN-Safety-20230105.xml

Set the checkbox 'I have checked all parameter entries' when the parameters are set the same as in your engineering software project.

5. Click on the button *Calculate iPar_CRC*.

6. Copy the calculated iPar_CRC value into the clipboard.

7. Navigate back to the engineering software project and go to the *F_iPar_CRC* field on page "Module parameters" of the respecting Safety I/O-Device. Enter the iPar_CRC (from the clipboard) into the field and press *Enter*. This causes an update of the below *F_Par_CRC*. The *F_Par_CRC* will be generated via the PROFIsafe parameter which includes the iPar_CRC. With the *F_iPar_CRC* and the *F_Par_CRC*, the I/O-Device is able to check the validity of the received parameters.

12 PDCT interface

To use a PDCT for the IO-Link ports of the device variant 0980 SSL 3031-121-007D-101, the following indices are supported:

Record data	IOLM proxy Slot 3 - Subslot 1	IOLD proxy Slot 3 - Subslot 2 / Port X7	IOLD proxy Slot 3 - Subslot 3 / Port X8
IOLM info	0xB000	–	–
PortConfiguration	0xB101 – 0xB102	–	–
PortStatus	0xB201 – 0xB202	–	–
IOLProcessData	0xB301 – 0xB302	–	–
IOL Call	0xB400	0xB400	0xB400
IOLD Backup	–	0xB901	0xB901

13 Diagnostics

13.1 Detailed diagnostics description

13.1.1 Detected error of the system/sensor power supply U_S

The voltage value for the incoming system/sensor power supply is monitored globally for the PROFINET device. If the voltage drops below approx. 18 V, or exceeds approx. 30 V, an error message is generated. The IO-Link specification requires at least 20 V at the L+ (pin1) output supply of the I/O ports. At least 21 V of U_S supply voltage for the IO-Link Master are required to minimize the risk of internal voltage drops in the IO-Link Master.



Caution: Ensure that the supply voltage measured at the most remote participant is not below 21 V DC from the perspective of the system power supply.

The following IO-Link Master diagnostic is generated:

Channel number of diagnostic	0x8000 (diagnostic not channel-specific)
Channel related diagnostic code	0x0002
Channel related diagnostic code message	Undervoltage

- ▶ For **disabled** U_S supply voltage fault alarms, the U_S indicator LED is "off" in case of voltage drops below approx. 18 V. No PROFINET diagnosis will be generated.
- ▶ For **enabled** U_S supply voltage fault alarms, the U_S indicator LED is "red" in case of voltage drops below approx. 18 V.

The voltage value for the incoming system/sensor power supply is additionally monitored by the functional safety circuit.

If U_S is <5 V... 10 V, an additional IO-Link Master diagnostic is generated:

Channel number of diagnostic	0x8000 (diagnostic not channel-specific)
Channel related diagnostic code	0x012E
Channel related diagnostic code message	Undervoltage of Sensor / System supply

If the undervoltage is detected for longer than 10 minutes, the safety system switches into safe state.

13.1.2 Detected error of the actuator power supply U_L

Applicable only for device variant 0980 SSL 3031-121-007D-101.

The voltage value for the incoming U_L power supply is monitored globally for the device. If U_L supply voltage alarms are enabled, an error message is generated in case the voltage drops below approx. 18 V or exceeds approx. 30 V.

If output channels are active, additional error messages caused by the voltage failure are generated on the I/O ports. U_L supply voltage alarms are disabled by default and can be enabled via parameterization.

The following IO-Link Master diagnostic is generated:

Channel number of diagnostic	0x8000 (diagnostic not channel-specific)
Channel related diagnostic code	0x0118
Channel related diagnostic code message	Low voltage or over voltage of actuator power supply (U_L)
Extended description	Check wire connection and U_L power supply inclusive tolerance

- ▶ For **disabled** U_L supply voltage fault alarms, the U_L indicator LED is "off" in case of voltage drops below approx. 18 V. No PROFINET diagnosis will be generated.
- ▶ For **enabled** U_L supply voltage fault alarms, the U_L indicator LED is "red" in case of voltage drops below approx. 18 V.

13.1.3 Overtemperature

Internal overtemperature detection of PROFINET IO device.

The device sends the following PROFINET diagnostic message in the case of a detected overtemperature:

Channel number of diagnostic	0x8000 (diagnostic not channel-specific)
Channel related diagnostic code	0x012D
Channel related diagnostic code message	Overtemperature of IO device

13.1.4 Overload/short-circuit of the I/O port sensor supply outputs

Overload or a short circuit between pin 1 (sensor supply channel A) and pin 3 (GND):

- ▶ X1 .. X8 for 0980 SSL 3030-121-007D-101
- ▶ X1 .. X4 for 0980 SSL 3031-121-007D-101

Channel number of diagnostics	0x01 .. 0x08 (0980 SSL 3030-121-007D-101) 0x01 .. 0x04 (0980 SSL 3031-121-007D-101)
Channel related diagnostic code	0x0120 or 0x0122 or 0x0124
Channel related diagnostic code message	Internal test pulse error on Channel A / Pin 1 or Short circuit of sensor supply on Channel A / Pin 1 or Test pulse overload on Channel A / Pin 1

Overload or a short circuit between pin 5 (sensor supply channel B) and pin 3 (GND):

- ▶ X1 .. X8 for 0980 SSL 3030-121-007D-101
- ▶ X1 .. X4 for 0980 SSL 3031-121-007D-101

Channel number of diagnostics	0x01 .. 0x08 (0980 SSL 3030-121-007D-101) 0x01 .. 0x04 (0980 SSL 3031-121-007D-101)
Channel related diagnostic code	0x0121 or 0x0123 or 0x0125
Channel related diagnostic code message	Internal test pulse error on Channel B / Pin 5 or Short circuit of sensor supply on Channel B / Pin 5 or Test pulse overload on Channel B / Pin 5

Overload or a short circuit between pin 1 (L+) and pin 3 (GND):

- ▶ X7 .. X8 for 0980 SSL 3031-121-007D-101

Channel number of diagnostics	0x07 .. 0x08
Channel related diagnostic code	0x1806
Channel related diagnostic code message	Short circuit at L+
Extended description	Short circuit on sensor power supply at pin 1 (L+) of I/O port. Check wire connection.

- ▶ The dedicated red port DIA indicator is active when an error is detected.

13.1.5 Detected discrepancy error on safety inputs

When safety inputs are configured in Two Channel Mode, an antivalence or equivalence diagnosis might occur.

Channel number of diagnostics	0x01 .. 0x08 (0980 SSL 3030-121-007D-101) 0x01 .. 0x04 (0980 SSL 3031-121-007D-101)
Channel related diagnostic code	0x0126
Channel related diagnostic code message	Discrepancy error on digital input port



Attention: If a detected discrepancy error is present for at least 24 hours, the error can no longer be cancelled and the affected inputs remain invalid until the module is restarted.

13.1.6 Overload/short circuit of Ch. A for X5 .. X6 F-DO

Applicable only for device variant 0980 SSL 3031-121-007D-101.

The Functional Safety digital outputs on Channel A (pin 4) are protected against short circuits and overloads. In case of a fault, the output is automatically switched to "inactive".

The device sends the following PROFINET diagnostic message in the case of a fault:

Channel number of diagnostics	0x05 .. 0x06
Channel related diagnostic code	0x0127 0x0129 (if pin 1 is used as ground for output) 0x012B
Channel related diagnostic code message	Short circuit error detected by signal read back on Channel A / Pin 4 or Short circuit of test pulse on Channel A / Pin 1 or Overload on Channel A / Pin 4

► The dedicated red port DIA indicator is active when an error is detected.



Attention: X5 .. X6 outputs are supplied by the U_L power.

13.1.7 Overload/short circuit of Ch. B for X5 .. X6 F-DO

Applicable only for device variant 0980 SSL 3031-121-007D-101.

The Functional Safety digital outputs on Channel B (pin 2) are protected against short circuits and overloads. In case of a fault, the output is automatically switched to "inactive".

The device sends the following PROFINET diagnostic message in the case of a fault:

Channel number of diagnostics	0x05 .. 0x06
Channel related diagnostic code	0x0128 0x012A (if pin 1 is used as ground for output) 0x012C
Channel related diagnostic code message	Short circuit error detected by signal read back on Channel B / Pin 2 or Short circuit of test pulse on Channel B / Pin 5 or Overload on Channel B / Pin 2

► The dedicated red port DIA indicator is active when an error is detected.



Attention: X5 .. X6 outputs are supplied by the U_L power.

13.1.8 Overload/short circuit of Ch. A for X7 .. X8 DO

Applicable only for device variant 0980 SSL 3031-121-007D-101.

The digital outputs on the Channel A (C/Q / pin 4) are protected against short circuits and overloads. In case of a fault, the output is automatically switched to "inactive" and then cyclically switched back to "active" when the default setting is used (DO Restart Mode Parameter = "Automatic Restart after Failure").

In DO Restart Mode Parameter = "Restart after Output Reset", the output must be set to "low" via PLC, before the output can be set again to "high".

When an output channel is activated (rising edge of the channel state), the channel errors are filtered for the period that you set using the *Surveillance-*

Timeout parameter during the configuration of the device. The value of this parameter can range from 0 to 255 ms; the factory setting is 80 ms.

The filter is used to avoid premature error messages when a capacitive load is activated.

The device sends the following PROFINET diagnostic message in the case of a fault:

Channel number of diagnostics	0x07 .. 0x08
Channel related diagnostic code	0x1811 or 0x1813
Channel related diagnostic code message	Short circuit at C/Q or Overcurrent at C/Q
Extended description	Short circuit or overload on digital output at pin 4 / Ch.A of IOL port in DIO mode. Check wire connection and also power supply or Overload on digital output at pin 4 / Ch.A of IOL port in DO mode. Check wire connection and also power supply

- ▶ The dedicated red port DIA indicator is active when an error is detected.



Attention: X7 .. X8 outputs are **supplied by the U_S power.**

13.1.9 Overload/short circuit of Ch. B for X7 .. X8 DO

Applicable only for device variant 0980 SSL 3031-121-007D-101.

The digital outputs on the Channel B (I/Q / pin 2) are protected against short circuits and overloads. In case of a fault, the output is automatically switched to "inactive" and then cyclically switched back to "active" when the default setting is used (DO Restart Mode Parameter = "Automatic Restart after Failure").

In DO Restart Mode Parameter = "Restart after Output Reset", the output must be set to "inactive" via PLC, before the output can be set again to "active".

When an output channel is activated (rising edge of the channel state), the channel errors are filtered for the period that you set using the *Surveillance-Timeout* parameter during the configuration of the device. The value of this parameter can range from 0 to 255 ms; the factory setting is 80 ms.

The filter is used to avoid premature error messages when a capacitive load is activated.

The device sends the following PROFINET diagnostic message in the case of a fault:

Channel number of diagnostics	0x07 .. 0x08
Channel related diagnostic code	0x1810 or 0x1812
Channel related diagnostic code message	Short circuit at I/Q or Overcurrent at I/Q
Extended description	Short circuit on digital output at pin 2 / Ch.B of I/O port in DO mode. Check wire connection and also power supply or Overload on digital output at pin 2 / Ch.B of I/O port in DO mode. Check wire connection and also U_{AUX} power supply

► The dedicated red port DIA indicator is active when an error is detected.



Attention: The outputs are **supplied by the U_S power.**

13.1.10 IO-Link C/Q error detection

Applicable only for device variant 0980 SSL 3031-121-007D-101.

If an IO-Link Device in COM mode is unplugged, an incorrect IO-Link Device is plugged in, or an electrical fault occurs (for example due to a short circuit), an error message is generated.

If parameter Pull Plug Alarms is enabled (default):

A pull sub-module alarm will be send to the PROFINET controller. A message text like the following will be visible in the controller diagnostic buffer: "Hardware component removed or missing".

- ▶ The dedicated green port IO-Link indicator is blinking when a device is missing.
- ▶ The dedicated red port DIA indicator is off when a device is missing.

If parameter Pull Plug Alarms is disabled & parameter Port Diagnostics is enabled:

The following diagnostic alarm will be sent to the PROFINET controller:

Channel number of diagnostics	0x07 .. 0x08
Channel related diagnostic code	0x1800
Channel related diagnostic code message	No Device/communication lost

- ▶ The dedicated green port IO-Link indicator is blinking when a device is missing.
- ▶ The dedicated red port DIA indicator is off when a device is missing.

13.1.11 Generic parameter error detection

When a device parameter will be written to an invalid address (e.g. Sub-Slot / Index) or the parameter data content is detected as invalid for the device, the following device specific diagnostic messages will be generated:

Channel number of diagnostics	0x8000 (diagnostics not channel-specific)
Channel related diagnostic code	0x0010
Channel related diagnostic code message	Parameter error

13.1.12 Process data mismatch error detection

Applicable only for device variant 0980 SSL 3031-121-007D-101.

The IO-Link Master checks the configured IO-Link Sub-module data length with the detected IO-Link Device data length. In dependency of the parameter *Input Fraction*, the IO-Link Master generates the following diagnostic message in case of a detected error:

Channel number of diagnostics	0x8000 (diagnostics not channel-specific)
Channel related diagnostic code	0x17FF
Channel related diagnostic code message	Process Data mismatch

13.1.13 Force mode diagnostic

Forcing of the I/O data is possible via the Web interface for the following device variant:

- ▶ 0980 SSL 3912-121-007D-101

In case of activated forcing, the following diagnostic message will be generated:

Channel number of diagnostics	0x8000 (diagnostics not channel-specific)
Channel related diagnostic code	0x000A
Channel related diagnostic code message	Simulation active

13.1.14 Internal module error detected

Internal module error states (e.g. internal abnormal states) will be reported by the following diagnostic message. For detailed information also use the Web interface of the device.

Channel number of diagnostics	0x8000 (diagnostics not channel-specific)
Channel related diagnostic code	0x0009
Channel related diagnostic code message	Error

13.2 Table of IO-Link Master diagnostic codes

The following table gives an overview of the defined diagnostic codes in PROFINET (0x0000 – 0x17FF) and IO-Link (0x1800 – 0xFFFF) specification. Not all listed codes are used.

Diagnostic code	Definition	Type
0x0000	Reserved	–
0x0002	Undervoltage	Error detection
0x0009	Error detected	Error detection
0x000A	Simulation active	Error detection
0x0010	Parameter error detected	Error detection
0x0118	Low voltage of actuator power supply (U_L). Check power supply	Error detection
0x011A	I/O mapping configuration faulty	Error detection
0x0120	Internal test pulse error detected on Channel A / Pin 1	Error detection
0x0121	Internal test pulse error detected on Channel B / Pin 5	Error detection
0x0122	Short circuit of sensor supply on Channel A / Pin 1	Maintenance
0x0123	Short circuit of sensor supply on Channel B / Pin 5	Maintenance
0x0124	Test pulse overload on Channel A / Pin 1	Error detection
0x0125	Test pulse overload on Channel B / Pin 5	Error detection
0x0126	Discrepancy error detected on digital input port	Error detection
0x0127	Short circuit error detected by signal read back on Channel A / Pin 4	Error detection
0x0128	Short circuit error detected by signal read back on Channel B / Pin 2	Error detection
0x0129	Short circuit of test pulse on Channel A / Pin 1	Error detection
0x012A	Short circuit of test pulse on Channel B / Pin 5	Error detection

Diagnostic code	Definition	Type
0x012B	Overload on Channel A / Pin 4	Error detection
0x012C	Overload on Channel B / Pin 2	Error detection
0x012D	Overtemperature of I/O device	Error detection
0x012E	Undervoltage of Sensor / System supply	Error detection
0x012F	Functional safety controller error 1	Error detection
0x0130	Functional safety controller error 2	Error detection
0x0131	Functional safety controller error 3	Error detection
0x0133	Internal Module Error detected	Error detection
0x0134	Safety program: F-I/O passivated	Error detection
0x17FF	Process Data mismatch – check submodule configuration	Error detection
0x1800	No Device	Error detection
0x1801	Startup parametrization error detected - check parameter	Error detection
0x1802	Incorrect VendorID - Inspection Level mismatch	Error detection
0x1803	Incorrect DeviceID – Inspection Level mismatch	Error detection
0x1804	Short circuit at C/Q – check wire connection	Error detection
0x1805	PHY over temperature – Check master temperature and load	Error detection
0x1806	Short circuit at L+ - check wire connection	Error detection
0x1807	Overcurrent at L+ - check power supply (e.g. L1+)	Error detection
0x1808	Device Event overflow	Error detection
0x1809	Backup inconsistency - memory out of range	Error detection
0x180A	Backup inconsistency – identity fault	Error detection
0x180B	Backup inconsistency – parameter storage unspecific error detected	Error detection
0x180C	Backup inconsistency – upload fault	Error detection
0x180D	Parameter inconsistency – download fault	Error detection
0x180E	P24 (Class B) missing or undervoltage	Error detection
0x180F	Short circuit at P24 (Class B) – check wire connection (e.g. L2+)	Error detection
0x1810	Short circuit at I/Q – check wiring	Error detection
0x1811	Short circuit at C/Q (if digital output) – check wiring	Error detection

Diagnostic code	Definition	Type
0x1812	Overcurrent at I/Q – check load	Error detection
0x1813	Overcurrent at C/Q (if digital output) – check load	Error detection
0x1814 to 0x1EFF	Reserved	
0x1F00 to 0x1FFF	Vendor specific	
0x2000 to 0x2FFF	Safety extensions	
0x3000 to 0x3FFF	Wireless extensions	
0x4000 to 0x5FFF	Reserved	
0x6000	Invalid cycle time	Error detection
0x6001	Revision fault	Error detection
0x6002	ISDU batch failed	Error detection
0x6003 to 0xFF20	Reserved	Error detection
0xFF21	Reserved	Notification
0xFF22	Reserved	Notification
0xFF23	Reserved	Notification
0xFF23	Reserved	Notification
0xFF24	Reserved	Notification
0xFF25	Reserved	Notification
0xFF26 ²	Port status changed	Notification
0xFF27 ²	Data Storage upload completed and new data object available	Notification
0xFF28 to 0xFF30	Reserved	
0xFF31	Reserved	Notification
0xFF32 to 0xFFFF	Reserved	Notification

² For IO-Link Master internal use

13.3 IO-Link Device diagnostics in PROFINET

Diagnostics (Events) of the IO-Link Device which are sent to the IO-Link Master, are reported to the PROFINET controller via a standard channel diagnostic or an extended channel diagnostic.

Standard channel diagnostic message:

Channel number of diagnostics	0x01 - 0x08
Channel related diagnostic code	Depends on IO-Link Device diagnostics
Channel related diagnostic code message	Depends on IO-Link Device diagnostics

Extended channel diagnostic message:

Channel number of diagnostics	0x01 - 0x08
Ext. channel related diagnostic code	IO-Link Device event code

For IO-Link event codes in the range of 0x8000 - 0x7FFF, the MSB bit will be set to "0" in the PROFINET extended channel diagnostic code.

Event Code

Diagnostic code reported by the IO-Link Device. Use the IO-Link Device documentation to interpret the error message.

Channel Number

1 - 8 of the IO-Link Master port whose connected device is reporting an error.

13.4 Table of IO-Link Device diagnostic codes

The following table shows the defined diagnostic codes (events) of the IO-Link specification. Use the IO-Link Device documentation for vendor specific codes.

Diagnostic code	Definition	Type
0x0000	No malfunction	Notification
0x1000	General malfunction – unknown error detected	Error detection
0x1001 to 0x17FF	Reserved	
0x1800 to 0x18FF	Vendor specific	
0x1900 to 0x33FF	Reserved	
0x4000	Temperature fault detected – Overload	Error detection
0x4001 to 0x420F	Reserved	
0x4210	Device temperature overrun – Clear source of heat	Warning
0x4211 to 0x421F	Reserved	
0x4220	Device temperature underrun – Insulate Device	Warning
0x4221 to 0x4FFF	Reserved	
0x5000	Device hardware fault detected – Device exchange	Error detection
0x5001 to 0x500F	Reserved	
0x5010	Component malfunction – Repair or exchange	Error detection
0x5011	Non volatile memory loss detected – Check batteries	Error detection
0x5012	Batteries low – Exchange batteries	Warning
0x5013 to 0x50FF	Reserved	
0x5100	General power supply fault detected – Check availability	Error detection
0x5101	Fuse blown/open – Exchange fuse	Error detection
0x5102 to 0x510F	Reserved	
0x5013 to 0x50FF	Reserved	

Diagnostic code	Definition	Type
0x5100	General power supply fault detected – Check availability	Error detection
0x5101	Fuse blown/open – Exchange fuse	detection
0x5102 to 0x510F	Reserved	
0x5110	Primary supply voltage overrun – Check tolerance	Warning
0x5111	Primary supply voltage underrun – Check tolerance	Warning
0x5112	Secondary supply voltage fault (Port Class B) detected – Check tolerance	Warning
0x5113 to 0x5FFF	Reserved	
0x6000		
0x6001 to 0x631F	Reserved	
0x6320	Parameter error detected – Check data sheet and values	Error detection
0x6321	Parameter missing – Check data sheet	Error detection
0x6322 to 0x634F	Reserved	
0x6350	Reserved	
0x6351 to 0x76FF	Reserved	
0x7700	Wire break of a subordinate device – Check installation	Error detection
0x7701 to 0x770F	Wire break of subordinate device 1 ...device 15 – Check installation	Error detection
0x7710	Short circuit – Check installation	Error detection
0x7711	Ground fault detected – Check installation	Error detection
0x7712 to 0x8BFF	Reserved	
0x8C00	Technology specific application fault detected – Reset Device	Error detection
0x8C01	Simulation active – Check operational mode	Warning
0x8C02 to 0x8C0F	Reserved	
0x8C10	Process variable range overrun – Process Data uncertain	Warning
0x8C11 to 0x8C1F	Reserved	
0x8C20	Measurement range exceeded – Check application	Error detection
0x8C21 to 0x8C2F	Reserved	
0x8C30	Process variable range underrun – Process Data uncertain	

Diagnostic code	Definition	Type
0x8C31 to 0x8C3F	Reserved	
0x8C40	Maintenance required – Cleaning	Warning
0x8C41	Maintenance required – Refill	Warning
0x8C42	Maintenance required – Exchange wear and tear parts	Warning
0x8C43 to 0x8C9F	Reserved	
0x8CA0 to 0x8DFF	Vendor specific	
0x8E00 to 0xAFFF	Reserved	
0xB000 to 0xB0FF	Reserved for Safety extensions	
0xB100 to 0xBFFF	Reserved for Profiles	
0xC000 to 0xFF90	Reserved	
0xFF91	Internal	Notification
0xFF92 to 0xFFAF	Reserved	
0xFFB0 to 0xFFB7	Reserved for Wireless extensions	
0xFFB8 to 0xFFFF	Reserved	

13.5 Error detection behavior of F-I/O

The Functional Safety I/O (F-periphery of PROFIsafe device) is linked to slot 2 of the PROFIsafe device.

13.5.1 Detected errors in failsafe digital inputs (F-DI)

If in 1-Channel-Mode a channel error (Ch. A / Pin 4 or Ch. B / Pin 2) is detected, the affected channel will be passivated (channel granular passivation).

If in 2-Channel-Mode a channel error is detected, both channels will be passivated.



For detected internal errors, the channel/module remains passivated until the device is restarted.

For detected external errors, the channel/module remains passivated until the error is resolved.



Note: The Bit 'Device Fault/ChF_Ack_Req' will always be set to '0'. After a channel error has been resolved, no acknowledgement must be done on the I/O module. If an unintended restart after a detected error shall be avoided in the future, this must be handled on the Host side (PROFIsafe Controller).

The module uses the mode 'No Channel Operator Acknowledge required' from specification 'Remote IO for Factory Automation', version 1.10 from August 2018.

A channel related qualifier bit in the safe input data shows the status of the channel:

0 = BAD

1 = GOOD

13.5.2 Detected errors in failsafe digital outputs (F-DO)



If a channel error (Ch. A / Pin 4 or Ch. B / Pin 2) is detected, the affected channel or all channels will be passivated (channel granular passivation).

If an internal hardware error is detected, all channels will be passivated.

The channel/module remains passivated until the error is resolved and acknowledged, or the module is power-cycled.



Note: The Bit 'Device Fault/ChF_Ack_Req' will always be set to '0'. After a channel error has been resolved, a power cycle of the I/O module is required in some cases. If an unintended restart of the outputs after a detected error shall be avoided, this must be handled on the Host side (F-PLC program).

The module uses the mode 'No Channel Operator Acknowledge required' from specification 'Remote IO for Factory Automation', version 1.10 from August 2018.



13.5.3 Detected errors in failsafe communication

In case of a detected Safety I/O communication error between the controller and the I/O device, the PROFIsafe profile specific error handling will be applied.

In case of a detected error, all digital outputs will be switched to failsafe value '0'.

After the detected error has been resolved, the device needs to be re-integrated.

13.5.4 Internal worst case delay time for F-DI of 0980 SSL 303x...

The time until an input signal change from "1" to "0" (in error free state) is available in the PROFINET send buffer in direction to the PLC.

This time does not include reaction times of connected sensors or additional delays of external error diagnostics caused by the selected channel mode (1-channel or 2-channel mode, with or without test pulse or evaluation mode).

Without activated IloT protocols

$$WCDT_{\text{Input}} = OFDT_{\text{Input}} = 42 \text{ ms}$$

With activated IloT protocols

$$WCDT_{\text{Input}} = OFDT_{\text{Input}} = 48 \text{ ms}$$

$WCDT_{\text{Input}}$ = Worst Case Delay Time, part of internal processing time

$OFDT_{\text{Input}}$ = One Fault Delay Time, part of internal processing time

($OFDT = WCDT$ with one internal fault)

13.5.5 Total worst case delay time for F-DI

Calculation of the total worst case delay time for F-DI in error free state:



Kind of delay		Time
Response time of connected sensor (field device)	Refer to manufacturer data	+
PROFIsafe device	Worst case delay time device: <u>Without activated IloT protocols</u> WCDT _{Input} = 42 ms <u>With activated IloT protocols</u> WCDT _{Input} = 48 ms	+
Transmission delay	Worst case delay time bus (Ethernet): 2 x PROFINET cycle time	+
F-PLC	F-Host delay time (refer to F-PLC data and settings)	+
Total worst case delay time for F-DI (input state changed until bit processed in F-PLC)		=

13.5.6 Internal worst case delay time for F-DO of 0980 SSL 303x...

The time of a changed available output data in the PROFINET receive buffer, until the output signal is switched to the new state on an F-DO channel.

Internal worst case delay time of F-DO for resistor loads:

Without activated IloT protocols

WCDT_{Output} = 44 ms

OFDT_{Output} = 48 ms

With activated IloT protocols

WCDT_{Output} = 50 ms

OFDT_{Output} = 54 ms

WCDT_{Output} = Worst Case Delay Time, part of internal processing time

OFDT_{Output} = One Fault Delay Time, part of internal processing time



Warning: For capacitive or inductive loads the $WCDT_{Output}$ and $OFDT_{Output}$ times can be increased.

13.5.7 Total worst case delay time for F-DO

The time required from an output state change in the controller until the new physical state is reached in the output channel under error-free conditions.

The total worst case delay time can be calculated as shown in the following example:

Kind of delay		Time
F-PLC	F-Host delay time (refer to F-PLC data and settings)	+
Transmission delay	Worst case delay time bus (Ethernet): 2 x PROFINET cycle time	+
PROFIsafe device	Worst case delay time device: <u>Without activated IloT protocols</u> $WCDT_{Output} = 44 \text{ ms}$ <u>With activated IloT protocols</u> $WCDT_{Output} = 50 \text{ ms}$	+
Switching time of connected actuator	Refer to manufacturer data	+
Total worst case delay time of failsafe output (PLC output change to new physical output state)		=

13.5.8 Total worst case delay time (TWCDT)

The total worst case delay time is the time until an F-Sensor state change is transferred to the F-PLC, processed in F-PLC and an appropriate F-DO is switched to the new state under error-free conditions.



Kind of delay		Time
Delay time of connected sensor (field device)	Refer to manufacturer data	+
PROFIsafe device (Input)	Worst case delay time device: <u>Without activated IloT protocols</u> WCDT _{Input} = 42 ms <u>With activated IloT protocols</u> WCDT _{Input} = 48 ms	+
Transmission delay	Worst case delay time bus (Ethernet): 2 x PROFINET cycle time	+
F-PLC	F-Host delay time (refer to F-PLC data and settings)	+
Transmission delay	Worst case delay time bus (Ethernet): 2 x PROFINET cycle time	+
PROFIsafe device (Output)	Worst case delay time device: <u>Without activated IloT protocols</u> WCDT _{Output} = 44 ms <u>With activated IloT protocols</u> WCDT _{Output} = 50 ms	+
Delay time of connected actuator	Refer to manufacturer data	+
TWCDT		=

13.5.9 Safety Function Response Time (SFRT)

$$\text{SFRT} = \text{TWCDT} + \Delta T_{\text{WD}} = \text{TWCDT} + \max(\text{WDTime} - \text{WCDT})$$

(Formula from IEC 61784-3-3, released 2018)

Max (WDTime - WCDT) is the maximum value of the following calculations for 0980 SSL 303x-... :

$$\Delta T_{\text{WD}} (\text{Input}) = \text{OFDT}_{\text{Input}} - \text{WCDT}_{\text{Input}} = 24 \text{ ms} - 24 \text{ ms} = 0$$

$$\Delta T_{\text{WD}} (\text{Output}) = \text{OFDT}_{\text{Output}} - \text{WCDT}_{\text{Output}} = 54 \text{ ms} - 50 \text{ ms} = 4 \text{ ms}$$

To be calculated application specific:

$$\Delta T_{\text{WD}} (\text{TD}_{\text{Input}}) = (\text{F_WD_Time} + \text{WCDT}_{\text{TD}} + \text{Tcy}_{\text{F-Host}})_{\text{TD}} - \text{WCDT}_{\text{TD}}$$



$\text{DAT}_{\text{Output}} = 60 \text{ ms}$ (without activated IloT protocols)

$\text{DAT}_{\text{Output}} = 72 \text{ ms}$ (with activated IloT protocols)

$\Delta T_{\text{WD}} (\text{TD}_{\text{Output}}) = (\text{F_WD_Time} + \text{WCDT}_{\text{TD}} + \text{DAT}_{\text{Output}})_{\text{TD}} - \text{WCDT}_{\text{TD}}$

Key:

WCDT = Worst Case Delay Time

$\text{WCDT}_{\text{F-Host}}$ = Worst Case Delay Time F-Host process

TD = Transmission delay (Bus/PROFINET Cycle)

WCDT_{TD} = Worst Case Delay Time Transmission Delay = PROFINET Cycle

$\text{Tcy}_{\text{F-Host}}$ = F-Host cycle time

14 IloT functionality

The LioN-Safety variants offer a number of new interfaces and functions for the optimal integration into existing or future IloT (Industrial Internet of Things) networks. The devices continue to work as field bus devices which communicate with and are controlled by a PLC (Programmable Logic Controller).

In addition, the devices offer common IloT interfaces, which enable new communication channels besides the PLC. The communication is performed via IloT-relevant protocols MQTT and OPC UA. With the help of these interfaces not only all information in a device can be read. They also enable its configuration and control, if the user wishes. All interfaces can be configured extensively and offer read-only functionality.

All LioN-Safety variants provide user administration, which is also applicable for accessing and configuring the IloT protocols. This allows you to manage all modification options for the device settings via personalized user authorizations.

All IloT protocols can be used and configured independently of the field bus. It is also possible to use the devices completely without the help of a PLC and control them via IloT protocols.



Attention: When using the IloT functionality, a protected local network environment without direct access to the Internet is recommended.

14.1 MQTT

The MQTT (Message Queuing Telemetry Transport) protocol is an open network protocol for machine-to-machine communication, which provides the transmission of telemetric data messages between devices. The integrated MQTT client allows the device to publish a specific set of information to an MQTT broker.

The publishing of messages can either occur periodically or be triggered manually.

14.1.1 MQTT configuration

In **delivery state**, MQTT functions are **disabled**. The MQTT client can be configured either using the Web interface or directly via a JSON object sent in an HTTP/HTTPS request. For more information see chapter [MQTT configuration - Quick start guide](#) on page 222.

The configuration URL is:

```
http://[ip-address]/w/config/mqtt.json
```

The configuration can also read back as a JSON file:

```
http://[ip-address]/r/config/mqtt.json
```

The configuration is a JSON object. Each JSON member is a configuration element. The object must not contain all elements. Only the provided elements will be changed. The configuration changes apply only after a device restart.

The following configuration elements are available (default values in bold):

Element	Data type	Description	Example data
mqtt-enable	boolean	Master switch for the MQTT client.	true / false
broker	string	IP address of the MQTT Broker	" 192.168.1.1 "
login	string	Username for MQTT Broker	"admin" (Default: null)
password	string	Password for MQTT Broker	"private" (Default: null)
port	number	Broker port	1883
base-topic	string	Base topic	"iomodule_[mac]" (Default: " lionx ")
will-enable	boolean	If true, the device provides a last will message to the broker	true / false
will-topic	string	The topic for the last will message.	(Default: null)
auto-publish	boolean	If true, all enabled domains will be published automatically in the specified interval.	true / false
publish-interval	number	The publish interval in ms if auto-publish is enabled. Minimum is 250 ms.	2000
publish-identity	boolean	If true, all identity domain data will be published	true / false
publish-config	boolean	If true, all config domain data will be published	true / false
publish-status	boolean	If true, all status domain data will be published	true / false
publish-process	boolean	If true, all process domain data will be published	true / false
publish-devices	boolean	If true, all IO-Link Device domain data will be published	true / false
commands-allowed	boolean	Master switch for MQTT commands. If false, the device will not subscribe to any command topic, even if specific command topics are activated below.	true / false
force-allowed	boolean	If true, the device accepts force commands via MQTT.	true / false
reset-allowed	boolean	If true, the device accepts restart and factory reset commands via MQTT.	true / false
config-allowed	boolean	If true, the device accepts configuration changes via MQTT.	true / false

Element	Data type	Description	Example data
qos	number	Selects the "Quality of Service" status for all published messages.	0 = At most once 1 = At least once 2 = Exactly once

Table 59: MQTT configuration

MQTT response:

The resulting response is a JSON object with a "status" field. Status should be "0" if no error occurred and "-1" if there is an error.

In case of an error, the response contains an error array.

The error array contains an error object for each error occurred. The object consists of a field "Element" which names the config element which caused the error, and a field "Message" for the error message.

- ▶ A malformed JSON object produces an error.
- ▶ Not existing parameters produce an error.
- ▶ Parameters with a wrong data type produce an error.

It is not allowed to write all available parameters at once. You may write only one or a limited number of parameters.

Examples:

```
{ "status": -1, "error": [{ "Element": "publish-interval", "Message": "Integer
expected" }] }

{ "status": 0 }

{ "status": -1, "error": [{ "Element": "root", "Message": "Not a JSON
object" }] }
```

For more information see chapter [MQTT topics](#) on page 210.

14.1.2 MQTT topics

MQTT mainly relates to topics. All messages are attached to a topic which adds context to the message itself. Topics may consist of any string and they are allowed to contain slashes (/) as well as wildcard symbols (*, #).

14.1.2.1 Base topic

For all LioN-Safety variants there is a configurable Base topic which is the prefix for all topics. The Base topic can be chosen freely by the user. The Base topic can also contain selected variables as shown in [Table 60: Base topic variables](#) on page 210.

Variables in the Base topic have to be written in brackets ("[]"). The following variables are possible:

Variable	Description
mac	The MAC address of the device
name	The name of the device
order	The ordering number of the device
serial	The serial number of the device

Table 60: Base topic variables

Example:

The Base topic "io_[mac]" translates to "io_A3B6F3F0F2F1".

All data is organized in domains. The domain name is the first level in the topic after the Base topic. Note the following notation:

Base-Topic/domain/....

There are the following domains:

Domain name	Definition	Example content
identity	All fixed data which is defined by the used hardware and which cannot be changed by configuration or at runtime.	Device name, ordering number, MAC address, port types, port capabilities and more.
config	Configuration data which is commonly loaded once at startup, mostly by a PLC.	IP address, port modes, input logic, failsafe values and more.
status	All (non-process) data which changes quite often in normal operation.	Bus state, diagnostic information, IO-Link Device status and data.
process	All process data which is produced and consumed by the device itself or by attached devices.	Digital inputs, digital outputs, cyclic IO-Link data.
iold	IO-Link Device parameters according to the IO-Link specification.	Vendor name, product name, serial number, hardware revision, software revision and more.

Table 61: Data domains

There is often one topic used for all gateway related information and topics for each port. All identity topics are published just once at start-up, because this information should never change. All other topics are published either in a fixed interval or just triggered manually, according to the configuration.

Topic	Content examples	Total publish count	Publish interval
[base-topic]/identity/gateway	Name, ordering number, MAC, vendor, I&M etc.	1	Startup
[base-topic]/identity/port/n	Port name, port type	8	Startup
[base-topic]/config/gateway	Configuration parameters, ip address etc.	1	Interval
[base-topic]/config/port/n	Port mode, data storage, mapping, direction	8	Interval
[base-topic]/status/gateway	Bus state, device diagnosis, master events	1	Interval
[base-topic]/status/port/n	Port or channel diagnosis, IO-Link state, IO-Link Device events	8	Interval
[base-topic]/process/gateway	All Digital IN/OUT	1	Interval
[base-topic]/process/port/n	Digital IN/OUT per port, IOL-data, pdValid	8	Interval
[base-topic]/iold/port/n	IO-Link Device parameter	8	Interval

Table 62: Data model

An MQTT client which wants to subscribe to one or more of these topics can also use wildcards.

Full topic	Description
[base-topic]/identity/gateway	Receive only indentity objects for the gateway
[base-topic]/identity/#	Receive all data related to the identity domain
[base-topic]/status/port/5	Receive only status information for port number 5
[base-topic]/+/port/2	Receive information of all domains for port number 2
[base-topic]/process/port/#	Receive only process data for all ports
[base-topic]/config/#	Receive config data for the gateway and all ports.

Table 63: Use case examples

14.1.2.2 Publish topic

Overview of all publish JSON data for the defined topics:

Key	Data type
product_name	json_string
ordering_number	json_string
device_type	json_string
serial_number	json_string
mac_address	json_string
production_date	json_string
fw_name	json_string
fw_date	json_string
fw_version	json_string
hw_version	json_string
vendor_name	json_string
vendor_address	json_string
vendor_phone	json_string
vendor_email	json_string
vendor_techn_support	json_string
vendor_url	json_string
vendor_id	json_integer
device_id	json_integer

Table 64: Identity/gateway

Key	Data type	Range	Default value	Remarks
fieldbus_protocol	json_string	PROFINET, EtherNet/IP, EtherCAT®		
ip_address	json_string		192.168.1.1	
subnet_mask	json_string		255.255.255.0	
report_alarms	json_boolean		0.0.0.0	
report_ul_alarm	json_boolean	true / false	true	
report_do_fault_without_ul	json_boolean	true / false	false	
force_mode_lock	json_boolean	true / false	false	
web_interface_lock	json_boolean	true / false	false	
do_auto_restart	json_boolean	true / false	true	
fast_startup	json_boolean	true / false	false	PROFINET and EIP only

Table 65: Config/gateway

Key	Data type	Range	Default value	Remarks
protocol	json_string	wait_for_io_system wait_for_io_Connection failsafe connected error		
ethernet_port1	json_string	100_mbit/s_full 100_mbit/s 10_mbit/s_full 100_mbit/s		
ethernet_port2	json_string	100_mbit/s_full 100_mbit/s 10_mbit/s_full 100_mbit/s		
module_restarts	json_integer	0 .. 4294967295		
channel_diagnosis	json_boolean	true / false		
failsafe_active	json_boolean	true / false		
system_voltage_fault	json_boolean	true / false		
actuator_voltage_fault	json_boolean	true / false		
internal_module_error	json_boolean	true / false		
simulation_active_diag	json_boolean	true / false		
us_voltage	json_integer	0 .. 32		in Volts
ul_voltage	json_integer	0 .. 32		in Volts
forcemode_enabled	json_boolean	true / false		

Table 66: Status/gateway

Key	Data type	Range	Default value	Remarks
Input_data	json_integer[]			
output_data	json_integer[]			

Table 67: Process/gateway

Key	Data type	Range	Default value	Remarks
port	json_integer	1 .. 8		
type	json_string	digital_universal digital_input digital_Output io_link		
max_output_power_cha	json_string	2.0_mA 0.5_mA		
max_output_power_chb	json_string	2.0_mA 0.5_mA		
channel_cha	json_string	input/output input output io_link aux		
channel_chb	json_string	input/output input output io_link aux		

Table 68: Identity/port/1 .. 8

Key	Data type	Range	Default value	Remarks
port	json_integer	1 .. 8		
direction_cha	json_string	input/output input output		
restart_mode_cha	json_string	Manual Auto		
restart_mode_chb	json_string	Manual Auto		
input_polarity_cha	json_string	NO NC		
input_polarity_chb	json_string	NO NC		
input_filter_cha	json_integer			ms
input_filter_chb	json_integer			ms
do_auto_restart_cha	json_boolean	true / false		
do_auto_restart_chb	json_boolean	true / false		

Table 69: Config/port/1 .. 8

Key	Data type	Range	Default value	Remarks
port	json_integer	1 .. 8		
physical_state_cha	json_integer	0 .. 1		
physical_state_chb	json_integer	0 .. 1		
actuator_short_circuit_cha	json_boolean	true / false		
actuator_short_circuit_chb	json_boolean	true / false		
sensor_short_circuit	json_boolean	true / false		
current_cha	json_integer			mA
current_chb	json_integer			mA
current_pin1	json_integer			mA

Table 70: Status/port/1 .. 8

14.1.2.3 Command topic (MQTT Subscribe)

The main purpose of MQTT is to publish data from the device to a broker. This data can then be received by any subscriber who is interested in this data. But also the other way round is possible. The device can subscribe to a topic on the broker and is then able to receive data. This data can contain configuration or forcing data. This allows the user to fully control a device via MQTT only, without using other ways of communication like Web or REST.

If the configuration allows commands in general, the device subscribes to special Command topics on which it can receive commands from other MQTT clients. The Command topic is based upon the Base topic. It always has the following form:

```
[base-topic]/command
```

After the Command topic, there are fixed topics for different writeable objects. The data format of the MQTT payload is always JSON. It is possible to set only a subset of the possible objects and fields.

[...]/forcing

Use the Command topic `[base-topic]/command/forcing` for *Force object* data. The *Force object* can contain any of the following properties:

Property	Data type	Example values	Remarks
forcemode	boolean	true / false	Forcing Authority: on/off
digital	array (Table 72: Force object: Digital on page 219)		
iol	array (Table 73: Force object: IOL (IO-Link devices only) on page 219)		

Table 71: Force object properties

For the *Force object* properties `digital` and `iol`, there are several value specifications arrayed:

Property	Data type	Example values	Remarks
port	integer	1, 2, 5	
channel	string	"a", "b"	
force_dir	string	"out", "in", "clear"	
force_value	integer	0, 1	

Table 72: Force object: Digital

Property	Data type	Example values	Remarks
port	integer	0, 1, 5	
output	array[integer]	[55, 88, 120]	
input	array[integer]		Input-Simulation

Table 73: Force object: IOL (IO-Link devices only)

[...]/config

Use the Command topic `[base-topic]/command/config` for *Config object* data. The *Config object* can contain any of the following properties:

Property	Data type	Example values	Remarks
portmode	array (Table 75: Config object: Portmode on page 220)		
ip_address	string	"192.168.1.5"	
subnet_mask	string	"255.255.255.0"	
gateway	string	"192.168.1.100"	

Table 74: Config object properties

For the *Config object* property `portmode`, there are several value specifications arrayed:

Property	Data type	Example values	Remarks
port	integer	2	
channelA*	string	"dio", "di", "do", "iol", "off"	
channelB*	string	"dio", "di", "do", "iol", "off", "aux"	
inlogicA	string	"no", "nc"	
inlogicB	string	"no", "nc"	
filterA	integer	3	input filter in ms
filterB	integer	3	input filter in ms
autorestartA	boolean		
autorestartB	boolean		
ioValidation	integer	0 = NoCheck 1 = Type 1.0 2 = Type 1.1 3 = Type 1.1 BR 4 = Type 1.1 RES	
ioDeviceID	integer		for validation
ioVendorID	integer		for validation

Table 75: Config object: Portmode

*channelA = Pin 4, channelB = Pin 2

[...]/reset

Use the Command topic `[base-topic]/command/reset` for *Reset object* data about restart and factory reset issues. The *Reset object* can contain any of the following properties:

Property	Data type	Example values	Remarks
factory_reset	boolean	true / false	
system_reset	boolean	true / false	

Table 76: Reset object properties

[...]/publish

Use the Command topic `[base-topic]/command/publish` for *Publish object* data.

Trigger publish of all topics manually (can be used when auto publish is off or long interval is set).

14.1.3 MQTT configuration - Quick start guide



Attention: Lumberg Automation™ is not responsible for any content of the referenced Web pages and provides no warranty for any functionality of the named third party software.

14.1.3.1 MQTT configuration via JSON

1. Depending on your application case, download and install *Insomnia* or a comparable application: <https://insomnia.rest/download/>

2. Configure MQTT:

POST: [IP-address]/w/config/mqtt.json

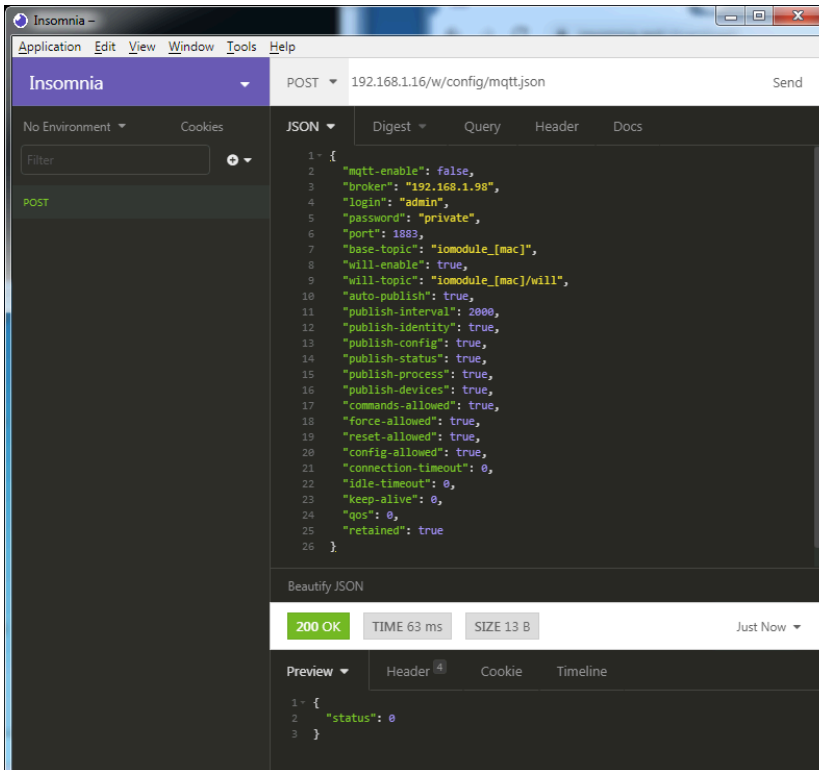

3. Read MQTT:

GET: [IP-address]/r/config/mqtt.json

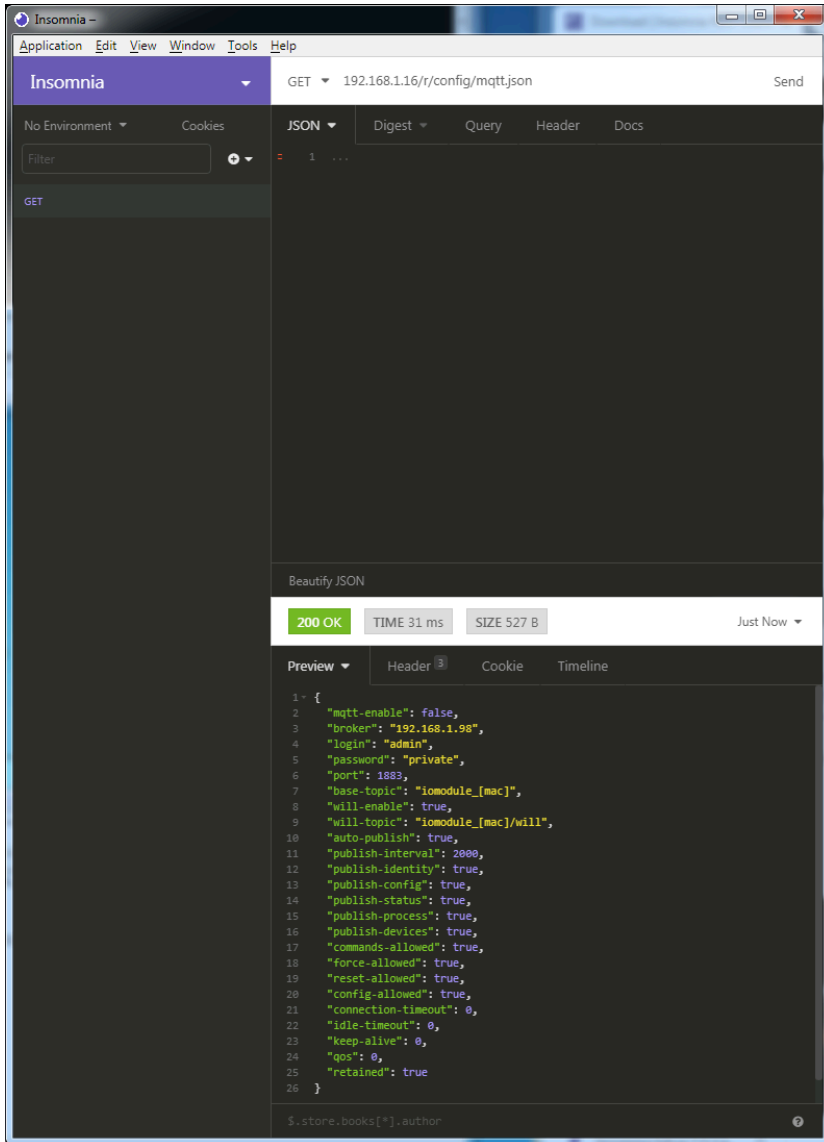

The screenshot shows the Insomnia REST client interface. The URL bar displays the endpoint `GET 192.168.1.16/r/config/mqtt.json`. The response status is `200 OK`, with a response time of `TIME 31 ms` and a response size of `SIZE 527 B`. The response body is a JSON object containing MQTT configuration parameters, which is displayed in the Preview tab.

```
1 {
2   "mqtt-enable": false,
3   "broker": "192.168.1.98",
4   "login": "admin",
5   "password": "private",
6   "port": 1883,
7   "base-topic": "iomodule_[mac]",
8   "will-enable": true,
9   "will-topic": "iomodule_[mac]/will",
10  "auto-publish": true,
11  "publish-interval": 2000,
12  "publish-identity": true,
13  "publish-config": true,
14  "publish-status": true,
15  "publish-process": true,
16  "publish-devices": true,
17  "commands-allowed": true,
18  "force-allowed": true,
19  "reset-allowed": true,
20  "config-allowed": true,
21  "connection-timeout": 0,
22  "idle-timeout": 0,
23  "keep-alive": 0,
24  "qos": 0,
25  "retained": true
26 }
```

14.2 OPC UA

OPC Unified Architecture (OPC UA) is a platform-independent standard with a service-oriented architecture for communication in and with industrial automation systems.

The OPC UA standard is based on the client-server principle and lets machines and devices, regardless of any preferred field bus, communicate horizontally among each other as well as vertically to the ERP system or the cloud. LioN-Safety provides an OPC UA server on field device level, with which an OPC UA client can connect for information exchange secure in transmission.

For OPC UA, we comply (apart from the exceptions listed [below](#)) with the IO-Link Companion Specification, which can be downloaded from catalog.belden.com or directly from io-link.com.

Feature	Support
Managing IODDs (chapter 6.1.6 in the specification)	Not supported
Mapping IODD information to OPC UA ObjectTypes (chapter 6.3 in the specification)	Not supported
IOLinkIODDDeviceType (chapters 7.2 ff. in the specification)	Not supported
ObjectTypes generated based on IODDs (chapters 7.3 ff. in the specification)	Not supported
Creation of Instances based on ObjectTypes generated out of IODDs (chapter 7.4 in the specification)	Not supported
IODDManagement Object (chapter 8.2 in the specification)	Not supported
RemoveIODD Method (chapter 8.3 in the specification)	Not supported

Table 77: Non-supported OPC UA features according to the IO-Link Companion Specification

14.2.1 OPC UA configuration

In **delivery state**, OPC UA functions are **disabled**. The OPC UA Server can be configured either using the Web interface or directly via a JSON Object sent in an HTTP/HTTPS request. For more information see [OPC UA configuration - Quick start guide](#) on page 228.

The configuration URL is:

```
http://[ip-address]/w/config/opcu.json
```

The configuration can also read back as a JSON file:

```
http://[ip-address]/r/config/opcu.json
```

The configuration is a JSON object. Each JSON member is a configuration element. The object must not contain all elements. Only the provided elements will be changed. All configuration changed applies only after a device restart.

There are the following configuration elements (default values in bold):

Element	Data type	Description	Example data
port	integer	Server port for the OPC UA server.	0, 4840 , 0xFFFF
opcua-enable	boolean	Master switch for the OPC UA server.	true / false
anon-allowed	boolean	If true, anonymous login is allowed.	true / false
commands-allowed	boolean	Master switch for OPC UA commands. If false there will be no writeable OPC UA objects.	true / false
force-allowed	boolean	If true, the device accepts force commands via OPC UA.	true / false
reset-allowed	boolean	If true, the device accepts restart and factory reset commands via OPC UA.	true / false
config-allowed	boolean	If true, the device accepts configuration changes via OPC UA.	true / false

Table 78: OPC UA Configuration

All configuration elements are optional and do not need a specific order. Not every element is required to be sent. This means that only configuration changes will be taken over.

Optional: The configuration parameters of OPC UA can be set directly via the Web interface. It is possible to download the Web interface for sharing with other devices.

Response:

The resulting response is a JSON object with a status field. Status should be "0" if no error occurred and "-1" if there is an error.

In case of an error, the response contains an error array.

The error array contains an error object for each error occurred. The object consists of a field "Element" which names the config element which caused the error, and a field "Message" for the error message.

Examples:

```
{ "status": -1, "error": [{"Element": "upcua-enable", "Message": "Boolean expected"}] }
{ "status": 0 }
{ "status": -1, "error": [{"Element": "root", "Message": "Not a JSON object"}] }
```

14.2.2 OPC UA address space

OPC UA provides different services on the LioN-Safety devices with which a client can navigate through the hierarchy of the address space and read or write variables. In addition, the client can monitor up to 10 attributes from the address space for value changes.

A connection to an OPC UA server is established via the endpoint URL:

```
opc.tcp://[ip-address]:[port]
```

Various device data such as MAC address, device settings, diagnostics or status information can be read via *Identity objects*, *Config objects*, *Status objects* and *Process objects*.

Command objects can be read and written. This makes it possible, for example, to transfer new network parameters to the device, to use Force Mode or to reset the entire device to its factory settings.

The following figures illustrate the OPC UA address space of the LioN-Safety devices. The objects and information displayed depend on the device variant used.

14.2.3 OPC UA configuration - Quick start guide



Attention: Lumberg Automation™ is not responsible for any content of the referenced Web pages and provides no warranty for any functionality of the named third party software.

14.2.3.1 OPC UA configuration via JSON

1. Depending on your application case, download and install *Insomnia* or a comparable application: <https://insomnia.rest/download/>

2. Configure OPC UA:

POST: [IP-address]/w/config/opcuajson

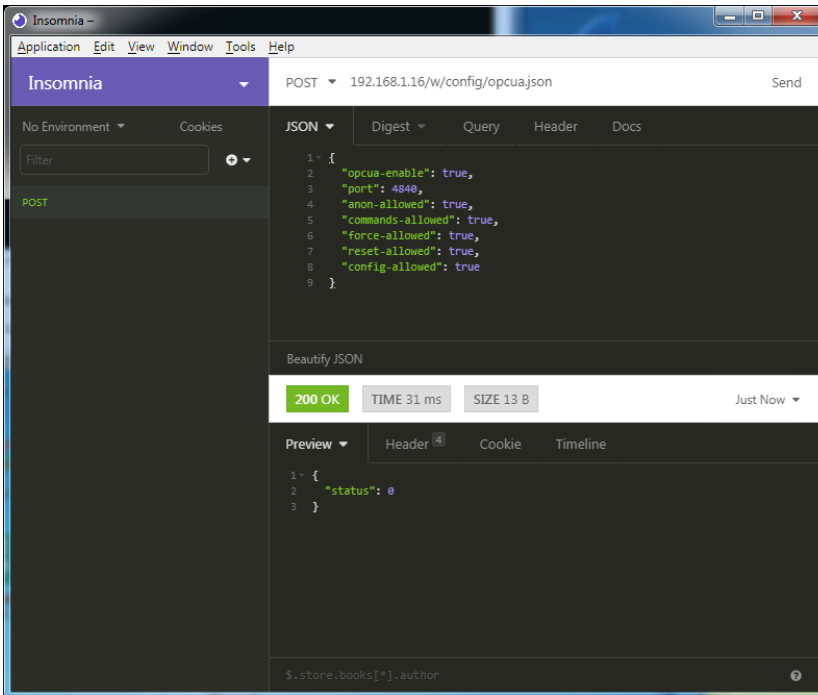

3. Read OPC UA:

GET: [IP-address]/r/config/opcuajson

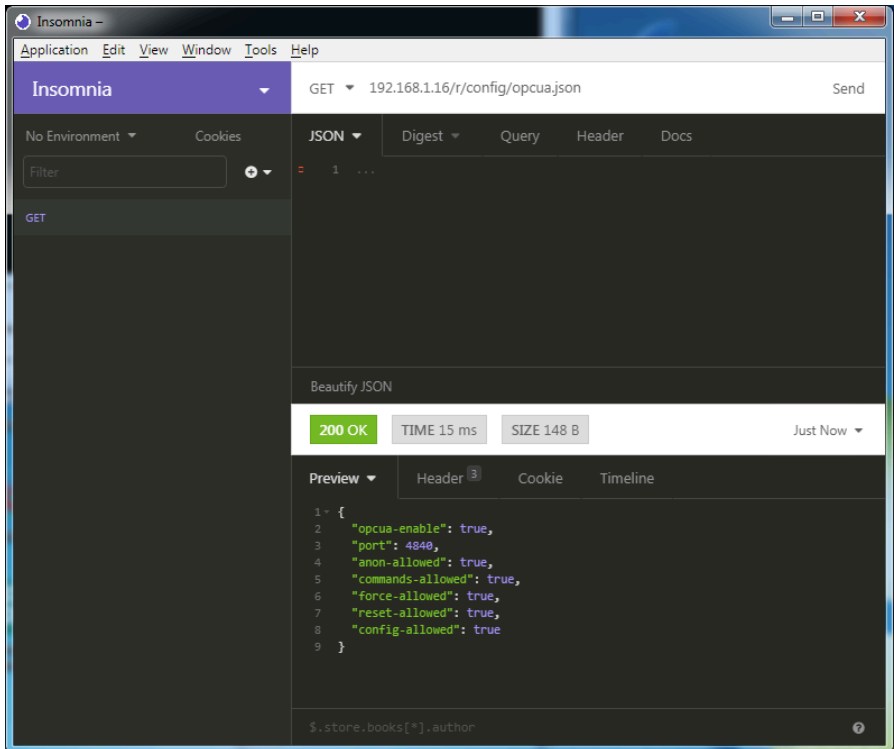

14.3 REST API

The Representational State Transfer – Application Programming Interface (REST API) is a programmable interface which uses HTTP requests to GET and POST data. This enables the access to detailed device information.

The REST API can be used to read the device status and to write configuration and forcing data.

There are two different REST API standards you can use for the requests:

1. A standardized REST API that has been specified by the IO-Link Community and is described separately:

JSON_Integration_10222_V100_Mar20.pdf

Please download the file from catalog.belden.com or directly from io-link.com.



Attention: Consider the following table to get an overview of the supported features of the IO-Link specification:

Feature		Supported
Gateway	GET /identification	Yes
	GET /capabilities	Yes
	GET /configuration	Yes
	POST /configuration	Yes
	POST /reset	Yes
	POST /reboot	Yes
	GET /events	Yes
Master	GET /masters	Yes
	GET /capabilities	Yes
	GET /identification	Yes
	POST /identification	Yes

Feature		Supported
Port	GET /ports	Yes
	GET /capabilities	Yes
	GET /status	Yes
	GET /configuration	Yes
	POST /configuration	Yes
	GET /datastorage	Not supported
	POST /datastorage	Not supported
Devices	GET /devices	Yes
	GET /capabilities	Yes
	GET /identification	Yes
	POST /identification	Yes
	GET /processdata/value	Yes
	GET /processdata/getdata/value	Yes
	GET /processdata/setdata/value	Yes
	POST /processdata/value	Yes
	GET /parameters	Not supported
	GET /parameters/{index}/subindices	Not supported
	GET /parameters/{parameterName}/subindices	Not supported
	GET /parameters/{index}/value	Not supported
	GET /parameters/{index}/subindices/{subindex}/value	Not supported
	GET /parameters/{parameterName}/value	Not supported
	GET /parameters/{parameterName}/subindices/{subParameterName}/value	Not supported
	POST /parameters/{index}/value	Not supported
	POST /parameters/{parameterName}/value	Not supported
	POST /parameters/{index}/subindices/{subindex}/value	Not supported
	POST /parameters/{parameterName}/subindices/{subParameterName}/value	Not supported
	POST /blockparametrization	Not supported
	GET /events	Yes

Feature		Supported
IODD	GET /iodds	Not supported
	POST /iodds/file	Not supported
	DELETE /iodds	Not supported
	GET /iodds/file	Not supported

Table 79: Support of REST API features according to the IO-Link specification

2. A customized Belden REST API that is described in the following chapters.

14.3.1 Standard device information

Request method:	http GET
Request URL:	<ip>/info.json
Parameters	n.a.
Response format	JSON

The goal of the "Standard device information" request is to get a complete snapshot of the current device status. The format is JSON. For IO-Link devices, all ports with connected IO-Link device information are included.

14.3.2 Structure

Name	Data type	Description	Example
name	string	Device name	"0980 XSL 3912-121-007D-00F"
order-id	string	Ordering number	"935 700 001"
fw-version	string	Firmware version	"V.1.1.0.0 - 01.01.2021"
hw-version	string	Hardware version	"V.1.00"
mac	string	MAC address of the device	"3C B9 A6 F3 F6 05"
bus	number	0 = No connection 1 = Connection with PLC	1
failsafe	number	0 = Normal operation 1 = Outputs are in failsafe	0
ip	string	IP address of the device	
snMask	string	Subnet Mask	
gw	string	Default gateway	
rotarys	array of numbers (3)	Current position of the rotary switches: Array element 0 = x1 Array element 1 = x10 Array element 2 = x100	
ulPresent	boolean	True, if there is a UL voltage supply detected within valid range	
usVoltage_mv	number	US voltage supply in mV	
ulVoltage_mv	number	UL voltage supply in mV (only available for devices with UL supply)	
inputs	array of numbers (2)	Real state of digital inputs. Element 0 = 1 Byte: Port X1 Channel A to Port X4 Channel B Element 0 = 1 Byte: Port X5 Channel A to Port X8 Channel B	\{128,3\}
output	array of numbers (2)	Real State of digital outputs. Element 0 = 1 Byte: Port X1 Channel A to port X4 Channel B Element 0 = 1 Byte: Port X5 Channel A to port X8 Channel B	\{55,8\}

Name	Data type	Description	Example
consuming	array of numbers (2)	Cyclic data from PLC to device	
producing	array of numbers (2)	Cyclic data from device to PLC	
diag	array of numbers (4)	<p>Diagnostic information</p> <p>Element 0 = 1 Byte: Bit 7: Internal module error (IME) Bit 6: Forcemode active Bit 3: Actuator short Bit 2: Sensor short Bit 1: U_L fault Bit 0: U_S fault</p> <p>Element 1 = 1 Byte: Sensor short circuit ports X1 .. X8.</p> <p>Element 2 = 1 Byte: Actuator short circuit ports X1 Channel A to X4 Channel B</p> <p>Element 3 = 1 Byte: Actuator short circuit ports X5 Channel A to X8 Channel B</p>	
fieldbus	FIELDBUS Object		
FIELDBUS Object			
fieldbus_name	string	Currently used fieldbus	
state	number	Fieldbus state	
state_text	number	Textual representation of fieldbus state: 0 = Unknown 1 = Bus disconnected 2 = Preop 3 = Connected 4 = Error 5 = Stateless	
forcing	FORCING Object	Information about the forcing state of the device	
channels	Array of CHANNEL (16)	Basic information about all input/output channels	

Name	Data type	Description	Example
iol	IOL Object	Contains all IO-Link related information such as events, port states, device parameters.	
iol/diagGateway	array of DIAG	Array of currently active device/gateway related events	
iol/diagMaster	array of DIAG	Array of currently active IOL-Master related events	
iol/ports	array of PORT (8)	Contains one element for each IO-Link port	
CHANNEL Object			
name	string	Name of channel	
type	number	Hardware channel type as number: 0 = DIO 1 = Input 2 = Output 3 = Input/Output 4 = IO-Link 5 = IOL AUX 6 = IOL AUX with DO 7 = IOL AUX with DO. Can be deactivated. 8 = Channel not available	
type_text	string	Textual representation of the channel type	
config	number	Current configuration of the channel: 0 = DIO 1 = Input 2 = Output 3 = IO-Link 4 = Deactivated 5 = IOL AUX	
config_text	string	Textual representation of the current config	
inputState	boolean	Input data (producing data) bit to the PLC	
outputState	boolean	Output data bit to the physical output pin	

Name	Data type	Description	Example
forced	boolean	True, if the output pin of this channel is forced	
simulated	boolean	True, if the input value to the PLC of this channel is simulated	
actuatorDiag	boolean	True, if the output is in short circuit / overload condition	
sensorDiag	boolean	True, if the sensor supply (Pin 1) is in short circuit / overload condition	
maxOutputCurrent_mA	number	Maximum output current of the output in mA	
current_mA	number	Measured current of the output in mA (if current measurement is available)	
voltage_mV	number	Measured voltage of this output in mV (if voltage measurement is available)	
PORT Object			
port_type	string	Textual representation of the IO-Link port type	
iolink_mode	number	Current port mode: 0 = Inactive 1 = Digital output 2 = Digital input 3 = SIO 4 = IO-Link	
iolink_text	string	Textual representation of the current port mode	"Digital Input"
aux_mode	number	Indicates the configured mode for the Pin 2: 0 = No AUX 1 = AUX output (always on) 2 = Digital output (can be controlled by cyclic data) 3 = Digital input	
aux_text	string	Textual representation of the current aux mode	"AUX Output"
cq_mode	number	Port mode according to IOL specification	
iq_mode	number	Pin2 mode according to IOL specification	

Name	Data type	Description	Example
port_status	number	Port status according to IOL specification	
ds_fault	number	Data storage error number	
ds_fault_text	string	Textual data storage error.	
device	DEVICE Object	IO-Link device parameters. → Null if no IO-Link communication active	
diag	array of DIAG (n)	Array of port related events	
DIAG Object			
error	number	Error code	
source	string	Source of the current error.	"device" "master"
eventcode	number	Event code according to IO-Link specification	
eventqualifier	number	Event qualifier according to IO-Link specification	
message	string	Error message	"Supply Voltage fault"
DEVICE Object		Standard parameters of the IOL-Device	
device_id	number		
vendor_id	number		
serial	string		
baudrate	string	Baudrate (COM1,2,3)	
cycle_time	number	Cycle time in microseconds	
input_len	array of numbers (n)	IOL input length in bytes	
output_len	array of numbers (n)	IOL output length in bytes	
input_data	array of numbers (n)	IOL input data	
output_data	array of numbers (n)	IOL output data	
pd_valid	number	"1", if IOL input data is valid	
pdout_valid	number	"1", if IOL output data is valid	
FORCING Object		Forcing information of the device	
forcingActive	boolean	Force mode is currently active	

Name	Data type	Description	Example
forcingPossible	boolean	True, if forcing is possible and force mode can be activated	
ownForcing	boolean	True, if forcing is performed by REST API at the moment	
forcingClient	string	Current forcing client identifier	
digitalOutForced	array of numbers (2)	The force values of all 16 digital output channels.	
digitalOutMask	array of numbers (2)	The forcing mask of all 16 digital output channels.	
digitalInForced	array of numbers (2)	The force values of all 16 digital input channels.	
digitalInMask	array of numbers (2)	The forcing mask of all 16 digital input channels.	

14.3.3 Configuration and forcing

Method:	POST
URL:	<ip>/w/force.json
Parameters:	None
Post-Body:	JSON Object

Property	Data type	Example values	Description
forcemode	boolean	true / false	Forcing authority on/off
portmode	array (Port mode object)		
digital	array (Digital object)		
iol	array (IOL object)		

Table 80: Root object

Property	Data type	Example values	Remarks
port	integer	0..7	
channel	integer	"a","b"	optional default is "a"
direction	string	"dio","di","do","iol", "off", "aux"	
aux	string	"dio","di","do","iol", "off", "aux"	IOL only, but optional
inlogica	string	"no","nc"	
inlogicb	string	"no","nc"	

Table 81: Port mode object

Property	Data type	Example values	Remarks
port	integer	0..7	
channel	string	"a","b"	
force_dir	string	"phys_out","plc_in","clear"	optional default is "phys_out"
force_value	integer	0,1	

Table 82: Digital object

Property	Data type	Example values	Remarks
port	integer	0..7	
output	array[integer] or null to clear forcing	[55,88,120]	Output forcing
input	array[integer] or null to clear forcing	[20,0,88]	Input simulation to PLC

Table 83: IOL object

14.3.4 Reading and writing ISDU parameters

The *Indexed Service Data Unit* (ISDU) provides a highly flexible message format, which can contain single or multiple commands.

LioN-Safety IOL-Masters with IIoT support reading and writing ISDU parameters from connected IOL-Devices. It is possible to do this as a bulk transfer by reading and writing of multiple ISDU parameters via a single request.

14.3.4.1 Reading ISDU

Method:	POST
URL:	<ip>/r/isdu.json
Parameters:	port (6 .. 7)
Example:	<code>192.168.1.20/r/isdu.json?port=5</code>
Post-Body:	JSON array of read ISDU object

Property	Data type	Example values	Remarks
ix	integer	0-INT16	Index to be read
subix	integer	0-INT8	Subindex to be read

Table 84: Read ISDU object

Property	Data type	Example values	Remarks
status	integer	0, -1	0 = no error, -1= an error occurred
message	string		Error Message if error occurred
data	array (Read ISDU data object)		data, if no error occurred. otherwise null

Table 85: Read ISDU response object

Property	Data type	Example values	Remarks
ix	integer	0-INT16	Index that was read
subix	integer	0-INT8	Subindex that was read
status	integer	0, -1	0 = no error, -1= an error occurred
eventcode	integer		IOL eventcode if status is -1
data	array[integer]		data, if no error occurred. otherwise null

Table 86: Read ISDU data object

14.3.4.2 Writing ISDU

Method:	POST
URL:	<ip>/w/isdu.json
Parameters:	port (6 .. 7)
Post-Body:	JSON array of write ISDU object

Property	Data type	Example values	Remarks
ix	integer	0-INT16	Index to be read
subix	integer	0-INT8	Subindex to be read
data	array[integer]		Data to be written

Table 87: Write ISDU object

Response: Write ISDU response object

Property	Data type	Example values	Remarks
status	integer	0, -1	0 = no error, -1= an error occurred
message	string		Error Message if error occurred
data	array (Write ISDU data object)		data, if no error occurred. otherwise null

Table 88: Write ISDU response object

Property	Data type	Example values	Remarks
ix	integer	0-INT16	Index that was written
subix	integer	0-INT8	Subindex that was written
status	integer	0, -1	0 = no error, -1= an error occurred
eventcode	integer		IOL eventcode if status is -1

Table 89: Write ISDU data object

14.3.5 Example: Reading ISDU

ISDU read request

```
[
  { "ix":5, "subix":0},
  { "ix":18, "subix":0},
  { "ix":19, "subix":0},
  { "ix":20, "subix":0}
]
```

Response

```
{
  "message": "OK",
  "data":
  [
    { "ix":5, "subix":0, "status":-1, "eventcode":32785},
    { "ix":18, "subix":0, "data":[79,68,83,49,48,76,49,46,56,47,76,65,54,44,50,
      48,48,45,77,49,50], "status":0},
    { "ix":19, "subix":0, "data":[53,48,49,50,57,53,51,53], "status":0},
    { "ix":20, "subix":0, "data":[100,105,115,116,97,110,99,101,32,115,101,110,
      115,111,114], "status":0}
  ],
  "status":0}
}
```

14.3.6 Example: Writing ISDU

ISDU write request

```
[
  { "ix":24, "subix":0, "data":[97,98,99,100,101,102]},
  { "ix":9, "subix":0, "data":[97,97,97,97,97,98]}
]
```

Response

```
{
  "message": "OK",
  "data": [
    { "ix":24, "subix":0, "status":0},
    { "ix":9, "subix":0, "eventcode":32785, "status":-1}
  ],
  "status":0}
}
```

14.4 CoAP server

The **Constrained Application Protocol** (CoAP) is a specialized Internet application protocol for constrained networks such as lossy or low power networks. CoAP is useful especially in M2M (Machine to Machine) communication and can be used to translate simplified HTTP requests of low speed networks.

CoAP is based on the Server-Client principle and a service layer protocol that lets nodes and machines communicate with each other. The LioN-Safety variants provide CoAP server functionalities via a REST API interface over UDP.

14.4.1 CoAP configuration

In delivery state, CoAP functions are *disabled*. The CoAP server can be configured either using the Web interface or directly via a JSON object sent in an HTTP/HTTPS request. For more information see chapter [CoAP configuration - Quick start guide](#) on page 250.

The configuration URL is:

```
http://[ip-address]/w/config/coapd.json
```

The configuration can also read back as a JSON file:

```
http://[ip-address]/r/config/coapd.json
```

The configuration is a JSON object. Each JSON member is a configuration element. The object must not contain all elements. Only the provided elements will be changed. The configuration changes apply only after a device restart.

The following configuration elements are available (default values in bold):

Element	Data type	Description	Example data
enable	boolean	Master switch for the CoAP server	true / false
port	integer (0 to 65535)	Port of the CoAP server	5683

Table 90: CoAP configuration

CoAP response:

The resulting response is a JSON object with a "status" field. Status should be "0" if no error occurred, and "-1" if there is an error.

In case of an error, the response contains an error array.

The error array contains an error object for each error occurred. The object consists of a field "Element" which names the config element that caused the error, and of a field "Message" for the error message.

Examples:

```
{ "status": -1, "error": [ { "Element": "upcua-enable", "Message": "Boolean
expected" } ] }

{ "status": 0 }

{ "status": -1, "error": [ { "Element": "root", "Message": "Not a JSON
object" } ] }
```

14.4.2 REST API access via CoAP

A connection to the CoAP server running on the LioN-Safety variants can be established via the following URL:

```
coap://[ip-address]:[port]/[api]
```

For LioN-Safety, the following REST API Requests (JSON format) can be accessed via a CoAP endpoint:

Type	API	Note
GET	/r/status.lr	
GET	/r/system.lr	
GET	/info.json"	
GET	/r/config/net.json	
GET	/r/config/mqtt.json	
GET	/r/config/opcuajson	
GET	/r/config/coapd.json	
GET	/r/config/syslog.json	
GET	/contact.json	
GET	/fwup_status	
GET	/iolink/v1/gateway/identification	
GET	/iolink/v1/gateway/capabilities	
GET	/iolink/v1/gateway/configuration	
GET	/iolink/v1/gateway/events	
GET	/iolink/v1/masters	
GET	/iolink/v1/masters/1/capabilities	
GET	/iolink/v1/masters/1/identification	
GET	/iolink/v1/masters/1/ports	
GET	/iolink/v1/masters/1/ports/{port_number}/capabilities	This API is available for all 8 ports. {port_number} should be between "1" and "8".
GET	/iolink/v1/masters/1/ports/{port_number}/status	This API is available for all 8 ports. {port_number} should be between "1" and "8".
GET	/iolink/v1/masters/1/ports/{port_number}/configuration	This API is available for all 8 ports. {port_number} should be between "1" and "8".
GET	/iolink/v1/devices/master1port{port_number}/identification	This API is available for all 8 ports. {port_number} should be between "1" and "8".

Type	API	Note
GET	/iolink/v1/devices/master1port{port_number}/capabilities	This API is available for all 8 ports. {port_number} should be between "1" and "8".
GET	/iolink/v1/devices/master1port{port_number}/processdata/getdata/value	This API is available for all 8 ports. {port_number} should be between "1" and "8".
GET	/iolink/v1/devices/master1port{port_number}/events	This API is available for all 8 ports. {port_number} should be between "1" and "8".

Table 91: REST API access via CoAP

14.4.3 CoAP configuration - Quick start guide



Attention: Lumberg Automation™ is not responsible for any content of the referenced Web pages and provides no warranty for any functionality of the named third party software.

14.4.3.1 CoAP configuration via JSON

1. Depending on your application case, download and install *Insomnia* or a comparable application: <https://insomnia.rest/download/>

2. Configure CoAP:

POST: [IP-address]/w/config/coapd.json

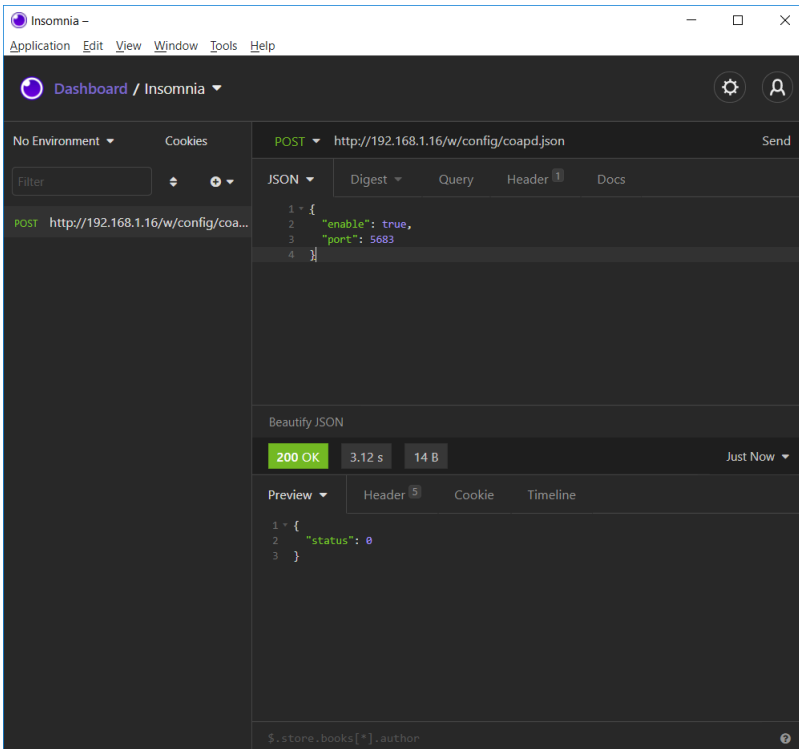

3. Read CoAP configuration:

GET: [IP-address]/r/config/coapd.json

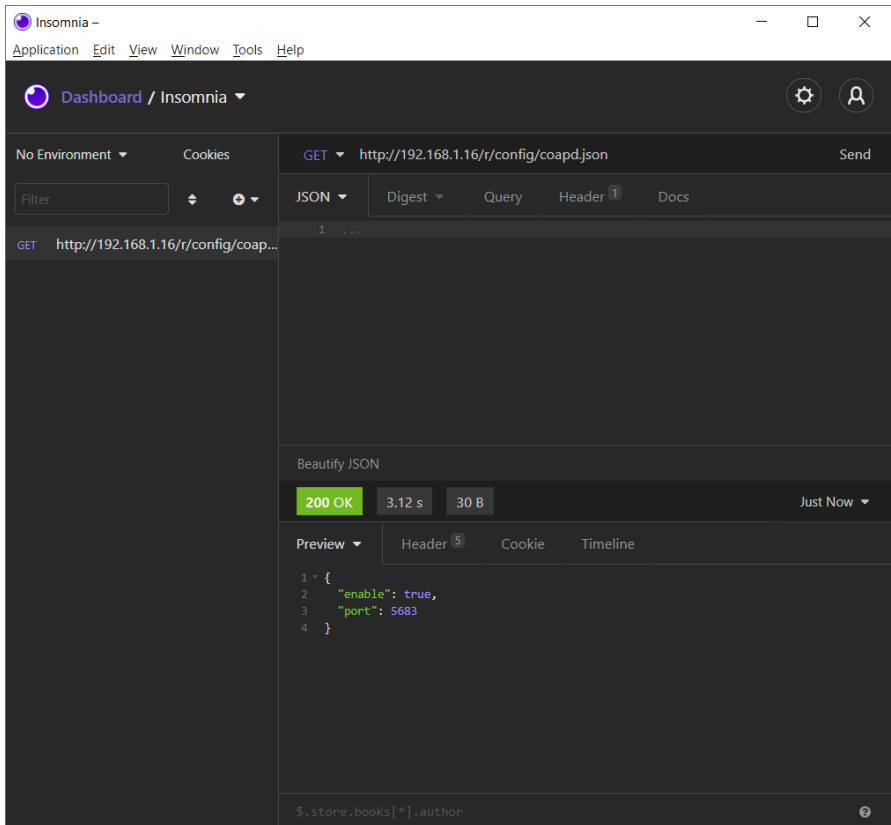

The screenshot shows the Insomnia REST client interface. The top bar displays the application name and menu options. The main area shows a REST client configuration for a GET request to `http://192.168.1.16/r/config/coapd.json`. The response is displayed in the JSON view, showing a 200 OK status, a response time of 3.12 s, and a body size of 30 B. The response body is a JSON object:

```
1 {
2   "enable": true,
3   "port": 5683
4 }
```

The interface also includes a 'Preview' tab showing the same JSON object, a 'Header' tab with 5 items, and a 'Cookie' tab. The bottom of the interface shows a JSON path `$.store.books[*].author`.

14.5 Syslog

The LioN-Safety variants provide a Syslog client which can connect with a configured Syslog server and is able to log messages.

Syslog is a platform-independent standard for logging messages. Each message contains a timestamp as well as information about the severity level and the subsystem. The Syslog protocol RFC5424 is based on the Server-Client principle and lets machines and devices send messages in the network and collect them centrally. (For more details on the used syslog standard, please refer to <https://datatracker.ietf.org/doc/html/rfc5424>.)

LioN-Safety supports the storage of 256 messages in a ring buffer which are sent to the configured Syslog server. When the ring is full with 256 messages, the oldest message is always replaced by the newly arriving messages. All messages can be saved on the Syslog server. The Syslog client of the IO-Link Master will not store any message permanently.

14.5.1 Syslog configuration

In **delivery state**, Syslog functions are **disabled**. The Syslog client can be configured either using the Web interface or directly via a JSON object sent in an HTTP/HTTPS request. For more information see chapter [Syslog configuration - Quick start guide](#) on page 255.

The configuration URL is:

```
http://[ip-address]/w/config/syslog.json
```

The configuration can also read back as a JSON file:

```
http://[ip-address]/r/config/syslog.json
```

The configuration is a JSON object. Each JSON member is a configuration element. The object must not contain all elements. Only the provided elements will be changed. The configuration changes apply only after a device restart.

The following configuration elements are available (default values in bold):

Element	Data type	Description	Example data
syslog-enable	boolean	Master switch for the Syslog client	true / false
global-severity	integer	<u>Severity level of Syslog client</u> 0 – Emergency 1 – Alert 2 – Critical 3 – Error 4 – Warning 5 – Notice 6 – Info 7 – Debug The client will log all messages of severity according to the setting, including all below levels.	0/1/2/ 3 /4/5/6/7
server-address	string (IP address)	IP address of the Syslog server	192.168.0.51 (Default: null)
server-port	integer (0 to 65535)	Server port of the Syslog server	514
server-severity	integer (0 to 7)	<u>Severity level of Syslog server</u> 0 – Emergency 1 – Alert 2 – Critical 3 – Error 4 – Warning 5 – Notice 6 – Info 7 – Debug	0/1/2/ 3 /4/5/6/7

Table 92: Syslog configuration

Syslog response:

The resulting response is a JSON object with a "status" field. Status should be "0" if no error occurred, and "-1" if there is an error.

In case of an error, the response contains an error array.

The error array contains an error object for each error occurred. The object consists of a field "Element" which names the config element that caused the error, and of a field "Message" for the error message.

Examples:

```
{ "status": -1, "error": [{"Element": "upcua-enable", "Message": "Boolean
expected"}]}

{ "status": 0 }

{ "status": -1, "error": [{"Element": "root", "Message": "Not a JSON
object"}]}
```

14.5.2 Syslog configuration - Quick start guide



Attention: Lumberg Automation™ is not responsible for any content of the referenced Web pages and provides no warranty for any functionality of the named third party software.

14.5.2.1 Syslog configuration via JSON

1. Depending on your application case, download and install *Insomnia* or a comparable application: <https://insomnia.rest/download/>

2. Configure Syslog:

POST: [IP-address]/w/config/syslog.json

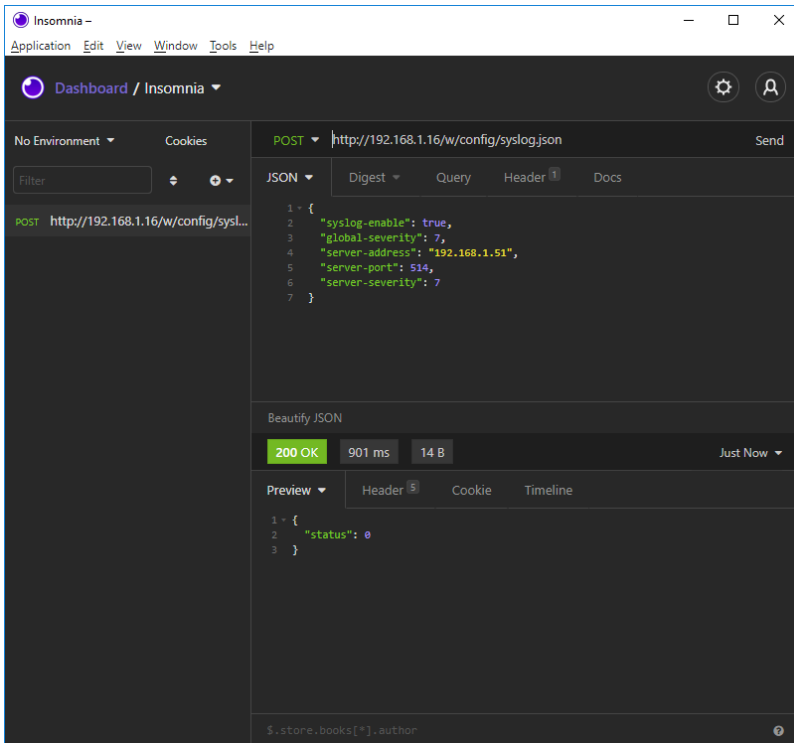

3. Read Syslog configuration:

GET: [IP-address]/r/config/syslog.json

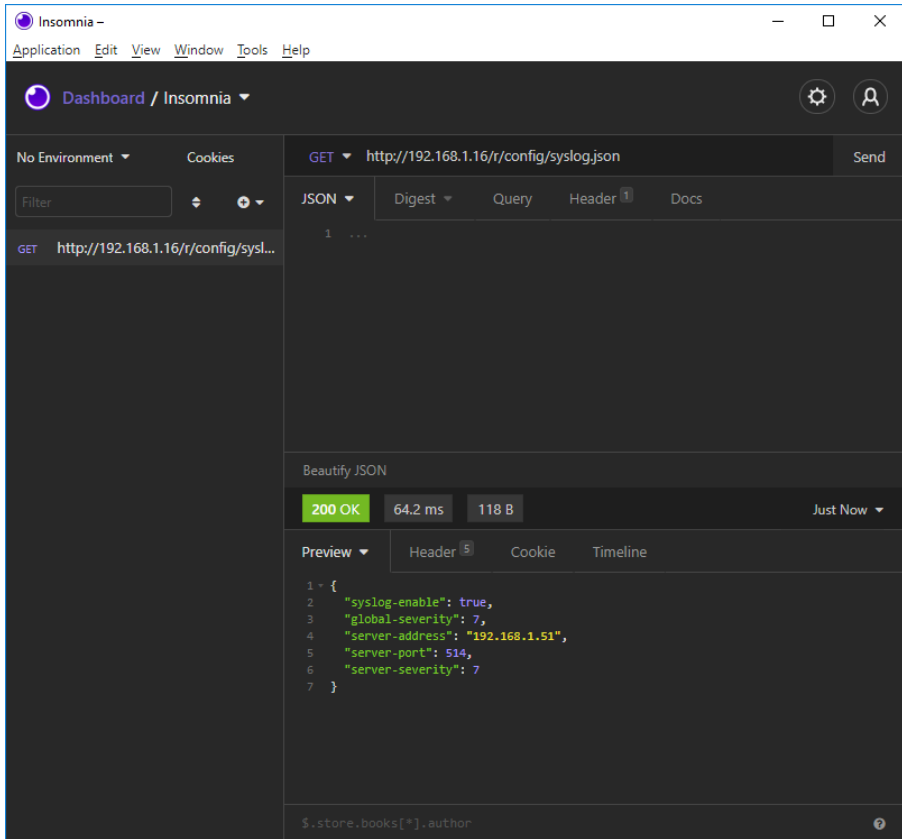

The screenshot shows the Insomnia REST client interface. The top bar displays the application name "Insomnia" and standard window controls. Below the menu bar, the "Dashboard / Insomnia" header is visible. The main interface is divided into several sections:

- Left Panel:** Shows "No Environment" and "Cookies" tabs. A "Filter" input field is present. Below it, a "GET" request is listed for the URL "http://192.168.1.16/r/config/syslog.json".
- Right Panel:** Displays the details of the selected request. The URL is "http://192.168.1.16/r/config/syslog.json". The response is shown in "JSON" format, with a status of "200 OK", a response time of "64.2 ms", and a size of "118 B". The response body is displayed in the "Preview" tab, showing a JSON object with the following structure:

```
1 {
2   "syslog-enable": true,
3   "global-severity": 7,
4   "server-address": "192.168.1.51",
5   "server-port": 514,
6   "server-severity": 7
7 }
```

14.6 Network Time Protocol (NTP)

The LioN-Safety variants provide an NTP client (version 3) which can connect with a configured NTP server and is able to synchronize the network time at a configurable interval.

NTP is a network protocol which uses UDP datagrams to send and receive timestamps in order to synchronize with a local clock. The NTP protocol RFC1305 is based on the Server-Client principle and exclusively supplies the synchronization with Coordinated Universal Time (UTC). (For more details on the used NTP standard, please refer to <https://datatracker.ietf.org/doc/html/rfc1305>.)

14.6.1 NTP configuration

In **delivery state**, the NTP client is **disabled**. The NTP client can be configured either using the Web interface or directly via a JSON object sent in an HTTP/HTTPS request. For more information see chapter [NTP configuration - Quick start guide](#) on page 259.

The configuration URL is:

```
http://[ip-address]/w/config/ntpc.json
```

The configuration can also read back as a JSON file:

```
http://[ip-address]/r/config/ntpc.json
```

The configuration is a JSON object. Each JSON member is a configuration element. The object must not contain all elements. Only the provided elements will be changed. The configuration changes apply only after a device restart.

The following configuration elements are available (default values in bold):

Element	Data type	Description	Example data
NTP client state	boolean	Master switch for the NTP client	true / false
Server address	string	IP address of the NTP server	192.168.1.50
Server port	integer	Port of the NTP server	123
Update interval	integer	Interval at which the client will connect with the configured NTP server (see table row "Server address"). Note: This value is in seconds.	1/2/10/ 60

Table 93: NTP configuration

NTP response:

The resulting response is a JSON object with a "status" field. Status should be "0" if no error occurred, and "-1" if there is an error.

In case of an error, the response contains an error array.

The error array contains an error object for each error occurred. The object consists of a field "Element" which names the configuration element that caused the error, and of a field "Message" for the error message.

Examples:

```
{
  "status": -1,
  "error": [
    {
      "Element": "ntpc-enable",
      "Message": "Boolean expected"
    }
  ]
}

{
  "status": 0
}

{
  "status": -1,
  "error": [
    {
      "Element": "root",
      "Message": "Not a JSON object"
    }
  ]
}
```

14.6.2 NTP configuration - Quick start guide



Attention: Lumberg Automation™ is not responsible for any content of the referenced Web pages and provides no warranty for any functionality of the named third party software.

14.6.2.1 NTP configuration via JSON

1. Depending on your application case, download and install *Insomnia* or a comparable application: <https://insomnia.rest/download/>

2. Configure NTP:

POST: [IP-address]/w/config/ntpc.json

The screenshot displays the Insomnia REST client interface. The top bar shows the application name 'Insomnia - Insomnia' and menu options: Application, Edit, View, Window, Tools, Help. The main area is divided into several sections:

- Environment:** No Environment, Cookies.
- Request:** Method: POST, URL: http://192.168.1.16/w/config/ntpc.json. The request body is a JSON object:

```
1 {
2   "enable": false,
3   "server-address": "192.168.1.8",
4   "server-port": 123,
5   "update-interval": 5
6 }
```
- Response:** Status: 200 OK, Time: 75.4 ms, Size: 14 B, Received: 8 Minutes Ago.
- Preview:** Shows the response body:

```
1 {
2   "status": 0
3 }
```
- Footer:** A JSON path filter: \$.store.books[*].author.

3. Read NTP configuration:

GET: [IP-address]/r/config/ntpc.json

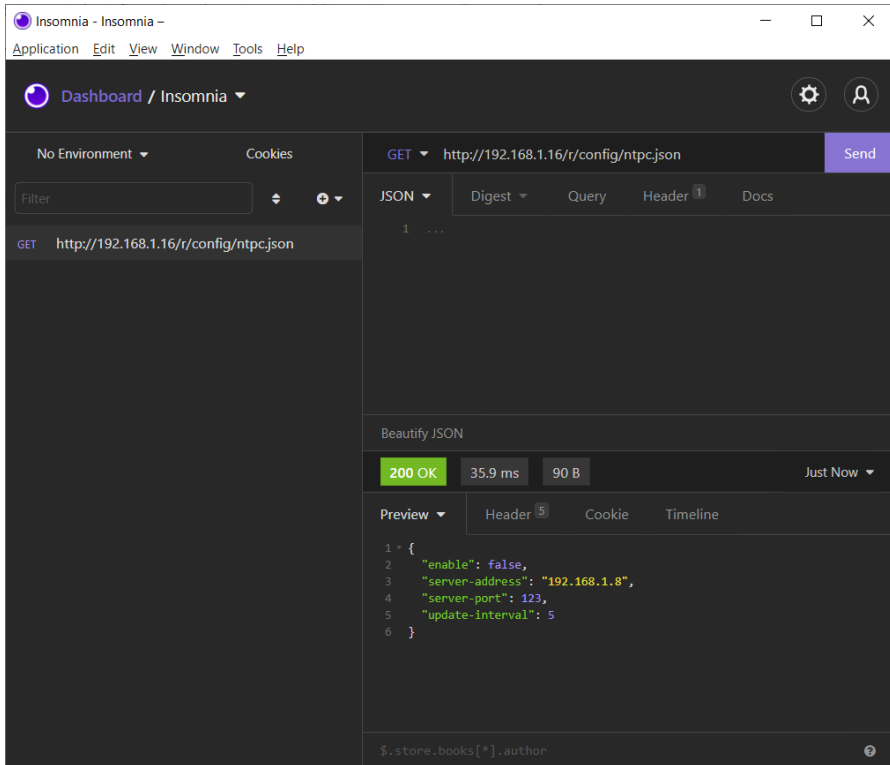

The screenshot shows the Insomnia REST client interface. The top bar displays "Insomnia - Insomnia" and "Application Edit View Window Tools Help". The main area is divided into several sections:

- Environment:** "No Environment" and "Cookies".
- Request:** Method "GET" and URL "http://192.168.1.16/r/config/ntpc.json". A "Send" button is visible.
- Response:** Status "200 OK", "35.9 ms", and "90 B". A "Just Now" timestamp is shown.
- Preview:** A JSON object is displayed:

```
1 {
2   "enable": false,
3   "server-address": "192.168.1.8",
4   "server-port": 123,
5   "update-interval": 5
6 }
```
- Footer:** A JSONPath expression "\$.store.books[*].author" is visible at the bottom.

15 The integrated Web server

All device variants are equipped with an integrated Web server which makes functions for the device configuration and the display of status and diagnostic information available via a Web interface.

The Web interface provides an overview of the configuration and status of the device. It is also possible to use the Web interface to trigger a reboot, reset to the factory defaults, or perform a firmware update.

Enter "http://" or "https://" followed by the IP address, such as "http://192.168.1.5", in your Web browser's address bar. If the status page of the device is not displayed, check your browser and firewall settings.

15.1 The Status page



Lion-X Web Interface

Status Ports System User Contact

Status

Device Overview

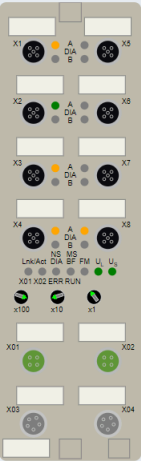

Device Information

Name: Lion-X 8xIO-Link Class A with Multiprotocol
 Application Version: 10.0 1.26228
 Fieldbus Version: 1.0 0.0
 Bus: OPERATE
 Device Diagnosis: Forcemode: Forcing is locked. Locked

Port Information

Channel	Type	Configuration	State	Dia	Details
X1 A	IO-Link	Digital Input 1 Bit In	On		ⓘ
X1 B	Digital Input/Output	Digital Input 1 Bit In	Off		
X2 A	IO-Link	IO-Link 4 Bytes In, 4 Bytes Out	Operate		ⓘ
X2 B	Digital Input/Output	Digital Input 1 Bit In	Off		
X3 A	IO-Link	Digital Output 1 Bit Out	On		ⓘ
X3 B	Digital Input/Output	Digital Input 1 Bit In	Off		ⓘ
X4 A	IO-Link	Digital Output 1 Bit Out	On		ⓘ
X4 B	Digital Input/Output	Digital Input 1 Bit In	Off		
X5 A	IO-Link	Digital Input 1 Bit In	Off		ⓘ
X5 B	Digital Input/Output	Digital Input 1 Bit In	Off		ⓘ
X6 A	IO-Link	Digital Input 1 Bit In	Off		ⓘ
X6 B	Digital Input/Output	Digital Input 1 Bit In	Off		ⓘ
X7 A	IO-Link	Digital Input 1 Bit In	Off		ⓘ
X7 B	Digital Input/Output	Digital Input 1 Bit In	Off		ⓘ
X8 A	IO-Link	Digital Output 1 Bit Out	On		ⓘ
X8 B	Digital Input/Output	Digital Input 1 Bit In	Off		

The status page provides a quick overview of the current state of the device.

The left side shows a graphical representation of the module with all its LEDs and the positions of the rotary encoding switches.

The right side shows the "Device Information" table with some basic data for the module; for example, the variant, the cyclic communication status and a diagnostic indicator. The indicator shows whether diagnostics for the module exist.

The "Port Information" table shows the configuration and state of the I/O ports.

15.2 The Ports page

lumbergautomation
A BELDEN BRAND

LioN-X Web Interface

Status Ports System User Contact

Port Details

Show details for port

X1 X2 X3 X4 X5 X6 X7 X8

Port Information		IO-Link	
Forcemode	Forcemode on	Vendor ID	362
Port	X2	Device ID	3674114
Type	IO-Link	Vendor Name	BELDEN Deutschland GmbH
Dia		Vendor Text	www.beldensolutions.com
Port Diagnosis		Product Name	0960 IOL 3E1-001
• No diagnosis		Product ID:	934992002
Pin 4 / Channel A		Product Text	LioN-P IO-Link (IO-Hub, 16DI)
Function	IO-Link	Serial No.	x42n
State	4 Bytes In, 4 Bytes Out	HW Revision	V1
Pin 2 / Channel B		FW Revision	V3.0.0.0
Function	Inactive	Speed	COM3
State	Inactive	Cycle time	1000
IO-Link Events		IODD	<input type="button" value="Upload"/>
• No events			<input type="button" value="Configure device"/>
		Application Name (Tag)	<input type="text" value="appTag7"/>
			<input type="button" value="Set"/>
			<input type="text" value="83 c8 00 00"/>
			<input type="button" value="Hex"/>
		Name	Value
		Port X1A	false
		Port X1B	false
		Port X2A	false
		Port X2B	false
		Port X3A	false
		Port X3B	false

The page shows detailed port information. In the field **Port Diagnosis**, incoming and outgoing diagnostics are displayed as clear text. **Pin 2** and **Pin 4** contain information about the configuration and state of the port. For IO-Link ports, additional information relating to the connected sensor and the process data is displayed.

15.3 The System page



A BELDEN BRAND

Lion-X Web Interface

Status
Ports
System
User
Contact

System

General Information

Firmware	
Application Version	10.0.1.26228
Fieldbus Version	1.0.0.0
Device	
Name	LiOn-X 8xIO-Link Class A with Multiprotocol
Product ID	0980 XSL 3912-121-007D-00F
Ordering Number	935700001
Hardware	1.0
Serial Number	123456
Production Date	2020-12-24T12:00:00Z
Ethernet	
MAC Address	3C:B9:A6:20:05:30
Network	
IP-Address	192.168.0.5
Subnetmask	255.255.255.0
Gateway	192.168.0.5
Source	Manual
Fieldbus	
Name	PROFINET
State	OPERATE

IP Settings

Parameter	Settings
IP-Address	<input type="text" value="0"/> . <input type="text" value="0"/> . <input type="text" value="0"/> . <input type="text" value="0"/>
Subnet Mask	<input type="text" value="0"/> . <input type="text" value="0"/> . <input type="text" value="0"/> . <input type="text" value="0"/>
Gateway	<input type="text" value="0"/> . <input type="text" value="0"/> . <input type="text" value="0"/> . <input type="text" value="0"/>
Startup configuration	<input checked="" type="radio"/> Static <input type="radio"/> DHCP

MQTT Config	OPC UA Server Config
Mqtt state	Disabled
Broker	192.168.1.1
Port	1883
Base Topic	lionx
Auto Publish	Yes
Publish Interval (ms)	2000
Publish Identity	Yes
Publish Config	Yes
Publish Status	Yes
Publish Process	Yes
Publish Devices	No
Will State	Disabled
Will Topic	
Listen for Commands	No
Process Forcing	No
Change Config	No
Device Reset	No
QOS	At most once

Restart device

Confirm to restart the device. All connections will be closed.

Reset configuration to factory defaults

Restoring factory settings affects all network parameters, including fieldbus specific settings. All network connections will be closed.

Note: If the module has rotary switches, the new IP address is equivalent to the rotary switch position.

Confirm to reset the device. All configuration data will be overwritten by default values!

Firmware update

The System page shows the basic information for the module like Firmware version, Device information, Ethernet, Network and Fieldbus information.

Restart Device

The module initializes a software reset.

Reset to Factory Settings

The module restores to the default factory settings.

IP Settings

Use this parameter to change the current IP address of the module.

For PROFINET, this is only useful during commissioning. Normally, the PLC sets the IP address at start-up by detecting the PROFINET module via its device name.

Firmware Update

A firmware update by the user is not intended for functionally safe I/O modules. If this should nevertheless be necessary, the following steps must be observed:

1. For the update, remove the module from all security functions.
2. Exclusively download the firmware currently released for the module.
3. Before the update, make sure that the upload file is unchanged (by verifying the hash value).
4. After the update, use the displayed values for version and CRC to verify whether the new firmware is on the module.
5. Document the (user-performed) verifications of the firmware update.

15.4 The User page



Lion-X Web Interface

Status Ports System User Contact

Users

Username	Edit	Del
admin		
user		

Add new user

The User page provides the user management of the Web interface. New users with access rights "Admin" or "Write" can be added here. For security reasons please change the default admin password immediately after configuring the device.

Default user login data:

- ▶ User: admin
- ▶ Password: private

16 IODD

IODD functions are **only** applicable for the following device variant:

- ▶ 0980 SSL 3031-121-007D-101

The **IO Device Description** (IODD) is a set of files formally describing an IO-Link Device. The IODD is created by the vendor and is mandatory for each IO-Link Device.

Belden IO-Link Masters with the "IODD on Module" functionality are ready to use IODDs in order to make the IO-Link Device configuration much more easier and the process data human readable in a better way. IODDs can be uploaded via the Web Interface and remanently stored on the IO-Link Master afterwards.

If a corresponding IO-Link Device is connected, the stored IODD is used to provide a user friendly configuration page, where all parameters of the device can be viewed and edited. Additionally, according to the IODD, the process data will also be formatted and displayed to the user.

16.1 IO-Link Device parameters and ISDU requests

Every IO-Link Device provides parameters that can be read and written via the special IO-Link service ISDU (**I**ndexed **S**ervice **D**ata **U**nit).

Every parameter is addressed by an index. Sub-indices are possible but optional. Some parameters (most of them read-only) are mandatory for IO-Link devices an can be found always on the same indices (See *Table B.8* in the *IO-Link Interface and System Specification*: https://io-link.com/share/Downloads/Package-2020/IOL-Interface-Spec_10002_V113_Jun19.pdf).

A vendor can use additional parameters and therefore more indices for their devices in order to provide additional configuration options. These vendor specific parameters can be described in an IODD. The "IODD on Module" feature of a LioN-Safety IO-Link Master can read and parse this information out of an IODD and use it to provide the user viewing and editing options

for vendor specific parameters without any additional knowledge about the vendor specific device features.

16.2 Web GUI functionality

All of the "IODD on Module" features are accessible via the LioN-Safety Web interface.

16.2.1 Port Details page

lumberg automation
A BELDEN BRAND

LioN-X Web Interface

Status Ports System User Contact

Port Details

Show details for port

X1 X2 X3 X4 X5 X6 X7 X8

Port Information		IO-Link	
Forcemode	Forcemode off	Vendor ID	362
Port	X2	Device ID	3674114
Type	IO-Link	Vendor Name	BELDEN Deutschland GmbH
Dia		Vendor Text	www.beldensolutions.com
Port Diagnosis		Product Name	0960 IOL 381-001
• No diagnosis		Product ID:	934992002
Pin 4 / Channel A		Product Text	LioN-P IO-Link I/O-Hub, 16DI
Function	IO-Link 4 Bytes In, 4 Bytes Out	Serial No.	x42n
State	Operate	HW Revision	V1
Pin 2 / Channel B		FW Revision	V3.0.0.0
Function	Inactive	Speed	COM3
State	Inactive	Cycle time	1000
IO-Link Events		IODD	<input type="button" value="Upload"/>
• No events			<input type="button" value="Configure device"/>
		Application Name (tag)	<input type="text" value="appTag7"/>
			<input type="button" value="Set"/>
			<input type="text" value="83 c9 00 80"/>
			<input type="button" value="HEX"/>
		Name	Value
		Port X1A	false
		Port X1B	false
		Port X2A	false
		Port X2B	false
		Port X3A	false
		Port X3B	false

The Port Details Page shows all information about the selected port. In the left column, all port and channel specific information is displayed. If the port is configured as IO-Link and there is an IO-Link Device connected, all IO-Link information for the connected device is displayed in the right column.

IODD buttons

The row called *IODD* provides access to the "IODD on Module" features. The button *UPLOAD* will let the user upload an IODD file into the module, regardless of the original device the IODD has been designed for.

The maximum number of IODDs is limited due to storage space. If there is no more space left for new IODDs, there will be an error message. In this case, navigate to the IODD Management page to delete IODDs which are no longer used.

If there is a matching IODD for the currently connected device already stored in the system, the button *CONFIGURE* is shown in the interface. By clicking this button, the Parameter Page will open to configure the device.

Process data

For every connected IO-Link Device, raw process data for input and output direction (set of bytes) is on display.

If a matching IODD providing information about process data is already stored in the system, this data will also be displayed in a user-friendly format according to the IODD.

16.2.2 Parameters page

IODD - Device configuration

Diagnosis

Parameter	Value	Unit	Min	Max	Description
Device Status	Device is OK				Indicator for the current device condition and diagnosis state.

Identification

Parameter	Value	Unit	Min	Max	Description
Vendor Name	BELEDEN Deutschland GmbH				The vendor name that is assigned to a Vendor ID.
Vendor Text	www.beldensolutions.com				Additional information about the vendor.
Product Name	0960 IOL 381-001				Complete product name.
Product ID	934992002				Vendor-specific product or type identification (e.g., item number or model number).
Product Text	LioN-P IO-Link I/O-Hub, 16DI				Additional product information for the device.
Serial Number	x42n				Unique, vendor-specific identifier of the individual device.
Hardware Revision	V1				Unique, vendor-specific identifier of the hardware revision of the individual device.
Firmware Revision	V3.0.0.0				Unique, vendor-specific identifier of the firmware revision of the individual device.
Application-specific Tag	<input type="text" value="appTag7"/>		0	32	Possibility to mark a device with user- or application-specific information.
Function Tag	<input type="text" value="functionTag5"/>		0	32	
Location Tag	<input type="text" value="locationTag5"/>		0	32	

Parameter

Parameter	Value	Unit	Min	Max	Description
User Serial Number	<input type="text" value="x42n"/>		0	16	
Module Identification ID	<input type="text" value="1"/>		0	127	

General Device Settings

Parameter	Value	Unit	Min	Max	Description
I/O data mapping	<input type="text" value="LioN-P"/>				
DIS-PRM-RST	<input type="text" value="enable parameter reset"/>				

General Diagnostic Settings

Parameter	Value	Unit	Min	Max	Description
Disable peripheral diagnosis	<input type="text" value="enable diagnosis"/>				

Input Filter

Parameter	Value	Unit	Min	Max	Description
Port X1A	<input type="text" value="off"/>				
Port X1B	<input type="text" value="0.5ms"/>				
Port X2A	<input type="text" value="1ms"/>				
Port X2B	<input type="text" value="2ms"/>				

The parameters page "IODD – Device configuration" shows all parameters which are provided by the IODD of the device. That means the parameter set is variable and depends on the connected IO-Link Device.

The stored IODD reads the parameter meta data, such as names, units, min/max values, descriptions etc. The values will be obtained directly from the connected device. For that reason it may take several seconds until the page is updated.

If not already saved into the browser, you will be asked for your credentials to continue. A valid user access with Web Interface group membership is needed in order to edit the device parameters. After the registration, enabled values can be changed. Disabled values cannot be changed and may be

marked as "read-only" in the IODD. All values are directly written back to the device after any change.

Limitations

- ▶ Editing parameter values will directly change them inside the connected device. No parameter server action is triggered by that.
- ▶ There is a maximum size of the IODD in order to be uploaded into the system. This depends on several values, such as file size, parameter count, nesting levels etc.

16.2.3 IODD Management page

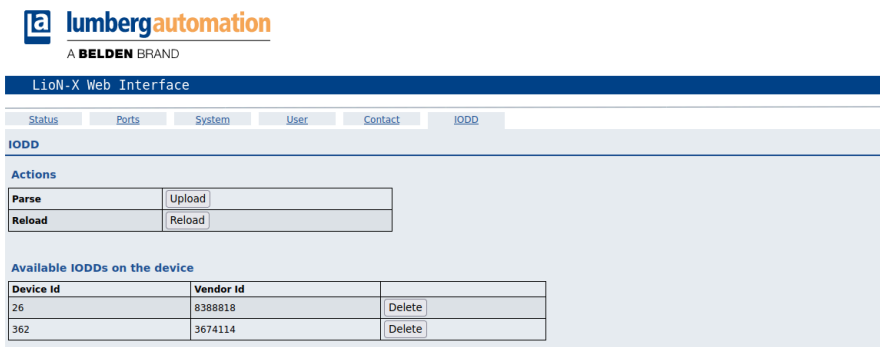

lumbergautomation
A BELDEN BRAND

LioN-X Web Interface

Status Ports System User Contact IODD

IODD

Actions

Parse	Upload
Reload	Reload

Available IODDs on the device

Device Id	Vendor Id	
26	8388818	Delete
362	3674114	Delete

The IODD Management Page can be accessed via the System page displaying all IODDs that are currently stored in the system. All IODDs matching connected devices are marked. On the IODD Management page, you can manually delete any IODD in the system.

Standard Definitions File

IODDs are usually referencing to a Standard Definitions File. The latest Standard Definitions File is already pre-installed on the system when the device is shipped. It can also be updated manually by clicking the button "Upload Standard Definitions File".

17 Technical data

The following sections give an overview of the most important functional data needed to operate the device. For further information and detailed technical data, see the respective **Data Sheet** of your required product in the product specific download area on catalog.belden.com.

17.1 Safety codes

Conditions:

The values are calculated for an average ambient temperature of +40 °C (+104 °F) and an installation altitude of up to 3000 m (9842 ft) and apply to a safety function consisting of one input/input pair and one output pair.

Mix modules 0980 SSL 3x31-121...		
Feature	Code	Standard
Performance Level (PL)	Up to e	EN ISO 13849-1
Category	Up to 4	EN ISO 13849-1
Safety Integration Level (SIL)	Up to 3	IEC 61508
MTTF	84 years	not standardized
PFH ($T_1 = 20$ years) (Communication PFH not included)	1.43 E-9 1/h	IEC 61508
MTTF _d	227 years	EN ISO 13849-1
DC _{avg}	99.37 %	EN ISO 13849-1
MTTR	24 h	EN ISO 13849-1

Table 94: Safety codes for mix modules 0980 SSL 3x31-121...

DI modules 0980 SSL 3x30-121...		
Feature	Code	Standard
Performance Level (PL)	Up to e	EN ISO 13849-1
Category	Up to 4	EN ISO 13849-1
Safety Integration Level (SIL)	Up to 3	IEC 61508
MTTF	107 years	not standardized
PFH ($T_1 = 20$ years) (Communication PFH not included)	1.32 E-9 1/h	IEC 61508
MTTF _d	255 years	EN ISO 13849-1
DC _{avg}	99.41 %	EN ISO 13849-1
MTTR	24 h	EN ISO 13849-1

Table 95: Safety codes for DI modules 0980 SSL 3x30-121...



Attention: The safety devices are designed for a lifetime (mission time) of 20 years (from a safety point of view). No proof test is required within the mission time. At the end of the mission time, the safety device must be taken out of service.

17.2 General

Protection class (Only applies if the connectors are screwed together or if protective caps are used.) ³	IP65 IP67 IP69K	
Ambient temperature (during operation and storage) ⁴	0980 SSL 3x31-121...	-40 °C .. +70 °C (-40 °F .. +158 °F)
	0980 SSL 3x30-121...	
Installation height (during operation and storage)	Up to +3000 m ASL (+9842 ft ASL)	
Weight	LioN-Safety 60 mm	approx. 500 gr. (17.6 oz)
Ambient moisture	Max. 98% RH (For UL applications: Max. 80% RH)	
Housing material	Die-cast zinc	
Surface finish	Frosted nickel	
Flammability class	UL 94 (IEC 61010)	
Vibration resistance (oscillation) DIN EN 60068-2-6 (2008-11)	15 g / 5-500 Hz	
Shock resistance DIN EN 60068-2-27 (2010-02)	50 g / 11 ms +/- X,Y,Z	
Fastening torques	M4 fixing screws	1 Nm
	M4 ground connection	1 Nm
	M12 connector	0.5 Nm
Permitted cables	Ethernet cables according to IEEE 802.3, min. CAT 5 (shielded) Max. length of 100 m, not routed out of facility (= local network)	

Table 96: General information

³ Not under UL investigation.

⁴ Restricted to -40 °C .. +63 °C (-40 °F .. +145 °F) at a level higher than +2000 m ASL (+6562 ft).

17.3 PROFINET protocol

Protocol	PROFINET IO device V2.44
Conformance Class	C (CC-C)
Netload Class	III
Update cycle	1 ms
GSDML file	GSDML-V2.44-LumbergAutomation-LioN-Safety-20240314.xml
Transmission rate	100 Mbit/s, full duplex
Transmission procedure Autonegotiation	100BASE-TX is supported
Vendor ID	16A _H
Device ID	0x0401 (same for all LioN-Safety variants)
Supported Ethernet protocols	Ping ARP LLDP SNMPv1 (network diagnostics) <ul style="list-style-type: none"> ▶ Read Community: public ▶ Write Community: private DCP HTTP TCP/IP MRP Client
PROFINET feature	Fast Start UP (Prioritized startup) Shared Device
Switch functionality	Integrated IRT is supported
PROFINET interface Connections Autocrossing	2 M12 sockets, 4-pin, D-coded (see pin assignments) 2 M12 Hybrid male/female, 8-pin is supported
Electrically isolated Ethernet ports -> FE	2000 V DC

Table 97: PROFINET protocol

17.4 Power supply of the module electronics/ sensors

Port X03, X04	M12-L-coded Power, connector/socket, 5-pole Pin 1 / Pin 3		
Nominal voltage U_S	24 V DC (SELV/PELV)		
Current I_S (X03/X04)	Max. 16 A		
Voltage range	18 .. 30 V DC		
Potential difference between power supply and FE	+24 V DC <-> FE	+32 V DC	
	GND <-> FE	-32 V DC	
Voltage range for IO-Link applications	21 .. 30 V DC		
Power consumption of module electronics	Typically 180 mA (+/-20 % at U_S nominal voltage)		
Power supply interruption internal	Max. 10 ms		
Voltage ripple U_S	Max. 5 %		
Current consumption sensor system (Pin 1 + Pin 5)	0980 SSL 3x31-121...	Port X1 .. X4 (Pin 1 + Pin 5)	max. 1.5 A per port, max. 9 A per device at $T_{\text{ambient}} = +30\text{ °C}$ (+86 °F)
		Port X7 .. X8 (L+ / Pin 1)	max. 4 A per port, max. 9 A per device at $T_{\text{ambient}} = +30\text{ °C}$ (+86 °F)
	0980 SSL 3x30-121...	Port X1 .. X8 (Pin 1 + Pin 5)	max. 1.5 A per port, max. 9 A per device at $T_{\text{ambient}} = +30\text{ °C}$ (+86 °F)
Voltage level of the sensor power supply	Min. ($U_S - 1.5\text{ V}$)		
Short circuit/overload protection of sensor supply	Yes, per port		

Reverse polarity protection	Yes	
Operational indicator (U _S)	LED green:	18 V (+/- 1 V) < U _S
	LED red:	U _S < 18 V (+/- 1 V)

Table 98: Information on the power supply of the module electronics/sensors

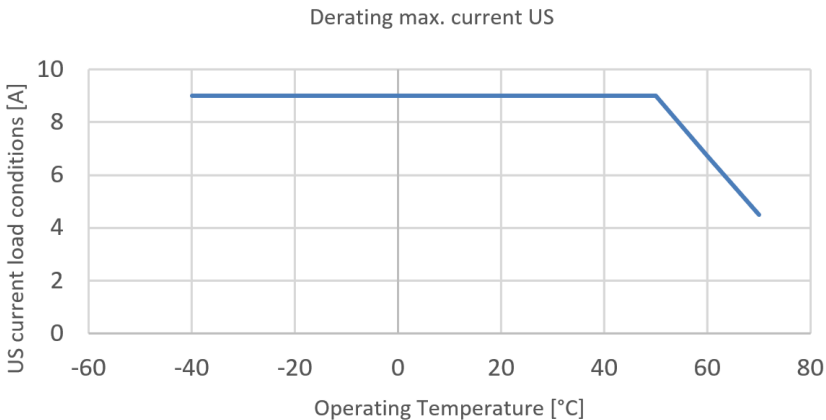

Figure 71: Derating of U_S



Attention: 

For F-DI changes caused by U_S power supply interrupts, the safety input data can be switched from '1' to '0'. The input change caused by the power interrupts will not be detected by an internal safety diagnostic circuit. This input change can result in an unwanted reaction in the safety application. A suitable power supply with buffering must be used to avoid power interrupts on U_S supply.



Caution: In case of a faulty SELV/PELV power supply unit, a maximum operating voltage of +60 V DC is possible at the U_S voltage supply (Pin1/Pin5) on the F-DI ports. The device variants 0980 SSL 303x-121... do not limit these maximum possible output voltages.

Confirm that the external connected sensors or actuators are designed for voltages up to +60 V DC.

17.5 Power supply of the actuators

Nominal voltage U_L	24 V DC (SELV/PELV)	
Voltage range	18 .. 30 V DC	
Potential difference between power supply and FE	+24 V DC <-> FE	+32 V DC
	GND <-> FE	-32 V DC
Current U_L (X03/X04)	Max. 16 A	
Voltage ripple U_L	Max. 5 %	
Reverse polarity protection	Yes	
Operational indicator (U_L)	LED green: 18 V (+/- 1 V) < U_L LED red: U_L < 18 V (+/- 1 V) or U_L > 30 V (+/- 1 V) * if "Report U_L supply voltage fault" is enabled.	
Port X03, X04	M12_L-coded Power, connector/socket, 5-pole Pin 2 / Pin 4	

Table 99: Information on the power supply of the actuators

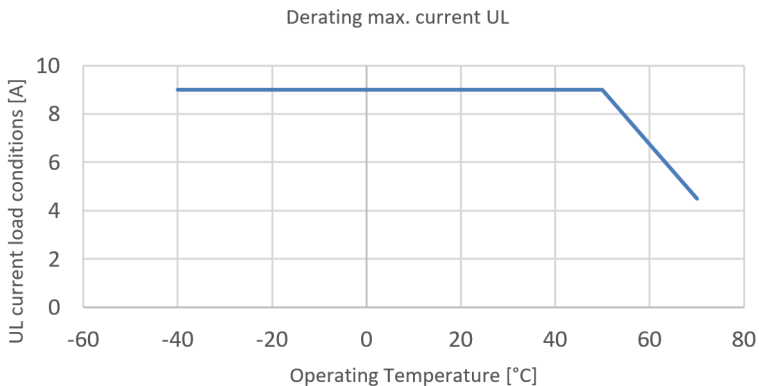

Figure 72: Derating of U_L



Caution: In case of a faulty SELV/PELV power supply unit, a maximum operating voltage of +60 V DC is possible at the U_L voltage supply (Pin 4/Pin2) on the F-DO ports. The device variants 0980 SSL 303x-121... do not limit these maximum possible output voltages. Confirm that the external connected sensors or actuators are designed for voltages up to +60 V DC.

17.6 FS DI ports

FS DI ports	0980 SSL 3x31-121...	Port X1 .. X4	M12 socket, 5-pin
	0980 SSL 3x30-121...	Port X1 .. X8	
Input connection	Type 3 as per IEC 61131-2		
Nominal input voltage	24 V DC		
Input current with 24 V DC	Typically 4 mA		
Short-circuit proof	Yes		
Channel type	Normally open, p-switching		
Safety state	Safe shut down → low Signal		
Number of digital inputs	0980 SSL 3x31-121...	4 (SIL 3, 1oo2) 8 (SIL 2, 1oo1)	
	0980 SSL 3x30-121...	8 (SIL 3, 1oo2) 16 (SIL 2, 1oo1)	
Status indicator	Yellow LED for channel A / White LED for channel B		
Diagnostic indicator	Red LED per channel		
Input filter	≤ 1 ms (only switch-off pulses)		
	12 ms (± 1 ms; only switch-off pulses)		

Table 100: FS DI ports (Digital Input): Functional overview



Attention: In the event of an unwanted reverse supply from a connected actuator with an external power supply, the maximum reverse voltage must be less than +60 V DC.

17.7 FS DO ports



Attention: For ports X5 and X6 the outputs are supplied by the U_L power supply.

FS DO ports	0980 SSL 3x31-121...	Port X5 .. X6	M12 socket, 5-pin
Output type	Normally open, pp-switching or ppm-switching		
Nominal output voltage per channel Signal status "1" Signal status "0"	min. ($U_L - 1\text{ V}$) max. 2 V		
Max. output current	0980 SSL 3x31-121...	per device:	max. 8.0 A per device at $T_{\text{ambient}} = +30\text{ °C}$ (+86 °F)
		per channel:	2.0 A
Short-circuit protection	Yes		
Overload protection	Yes		
FS-DO loads	In general:	Resistive, inductive and capacitive loads	
	For UL applications:	DC general use, DC resistance, DC Pilot duty according to UL/CSA/IEC 61010-2-201	
Behavior in case of short circuit or overload	Deactivation with automatic power-on		
Safe state	Safe shut down → high impedance		
Number of digital outputs	0980 SSL 3x31-121...	4 (SIL 3,1oo2)	
Status indicator	Yellow LED for channel A / White LED for channel B		
Diagnostic indicator	Red LED per channel		

Table 101: FS DO ports (Digital Output): Functional overview



Attention: In the event of an unwanted reverse supply from a connected actuator with an external power supply, the maximum reverse voltage must be less than +60 V DC.

17.8 IO-Link Master ports Class A

0980 XSL 3x31-121...	Port X7 .. X8	M12 socket, 5-pin
----------------------	---------------	-------------------

Table 102: IO-Link Master ports Class A

17.8.1 Configured as digital input (Pin 4 + Pin 2)

Input connection	0980 SSL 3x31-121...	Type 1 as per IEC 61131-2
Nominal input voltage	24 V DC	
Input current	Typically 3 mA	
Channel type	Normally open, p-switching	
Number of digital inputs	0980 SSL 3x31-121...	4
Status indicator	Yellow LED	
Diagnostic indicator	Red LED per channel	

Table 103: IO-Link Master Class A ports, configured as digital input

17.8.2 Configured as digital output (Pin 4 + Pin 2)



Attention: For ports X7 and X8 the outputs are supplied by the U_S power supply.

Output type	Normally open, p-switching		
Nominal output voltage per channel	min. ($U_L - 1\text{ V}$) max. 2 V		
Signal status "1"			
Signal status "0"			
Max. output current	0980 SSL 3x31-121...	per device:	max. 8.0 A per device at $T_{\text{ambient}} = +30^\circ\text{ C}$ (+86° F)
		per channel:	2.0 A
Short-circuit protection	Yes		
Overload protection	Yes		
Non-Safety DO loads	In general:	Resistive, inductive and capacitive loads	
	For UL applications:	DC general use, DC resistance, DC Pilot duty according to UL/CSA/IEC 61010-2-201	
Behavior in case of short circuit or overload	deactivation with automatic power-on		
Number of digital outputs	0980 XSL 3x31-121...	4	
Status indicator	Yellow LED per output		
Diagnostic indicator	Red LED per channel		

Table 104: IO-Link Master ports, configured as digital output

17.8.3 Configured as IO-Link port in COM mode (Pin 4)

IO-Link Master specification	v1.1.3 ready, IEC 61131-9	
Communication rates	4.8 kbaud (COM 1) 38.4 kbaud (COM 2) 230.4 kbaud (COM 3)	
Line lengths in the IO-Link Device	max. 20 m	
Number of IO-Link ports	0980 SSL 3x31-121...	2
Min. IO-Link cycle time	400 μ s	

Table 105: Configured as IO-Link port in COM mode

17.9 LEDs

LED	Color	Description
U _L	Green	Auxiliary actuator voltage OK $18\text{ V (+/- 1 V)} < U_L < 30\text{ V (+/- 1 V)}$
	Red*	Auxiliary actuator voltage LOW $U_L < 18\text{ V (+/- 1 V)}$ or $U_L > 30\text{ V (+/- 1 V)}$ * if "Report U _L supply voltage fault" is enabled.
	OFF	None of the above conditions.
U _S	Green	System/sensor voltage OK $18\text{ V (+/- 1 V)} < U_S < 30\text{ V (+/- 1 V)}$
	Red	System/sensor voltage LOW $U_S < 18\text{ V (+/- 1 V)}$ or $U_S > 30\text{ V (+/- 1 V)}$
	Red flashing	Device performs a factory reset (position of rotary encoding switches: 9-7-9)
X1 .. X8 A (for 0980 SSL 3x30-121...) X1 .. X6 A (for 0980 SSL 3x31-121...)	Yellow	Channel status A "on".
	Red	Internal or peripheral error detected
X1 .. X8 B (for 0980 SSL 3x30-121...) X1 .. X6 B (for 0980 SSL 3x31-121...)	White	Channel status B "on".
	Red	Internal or peripheral error detected
BF	Red	Bus fault. No configuration, no or slow physical connection.
	Red flashing at 2 Hz	Link exists but no communication link to the PROFINET controller.
	OFF	PROFINET controller has established an active connection to the device.
DIA	Red	Periphery error (sensor or actuator overload/short circuit).
	OFF	Status "OFF", no error.

LED	Color	Description
X7 .. X8 A (only 0980 SSL 3x31-121...)	Green	IO-Link COM Mode: IO-Link communication exists.
	Green flashing	IO-Link COM Mode: No IO-Link communication.
	Yellow	Standard I/O Mode: Status of digital input or output on C/Q (pin 4) line "on".
	OFF	None of the above conditions.
X7 .. X8 B (only 0980 SSL 3x31-121...)	White	Status of digital input or digital output on pin 2 line "on".
	Red	Short circuit on C/Q (pin 4) line / All modes: Overload or short circuit on L+ (pin 1) line / communication error
	OFF	None of the above conditions.
P1 Lnk/Act P2 Lnk/Act	Green	Ethernet connection to another subscriber exists. Link detected.
	OFF	No connection to another subscriber. No link, no data exchange.
	Yellow flashing	Data exchange with another subscriber.

Table 106: Information on the LED colors

17.10 Data transfer times for non-Safety I/O

The following tables give an overview of the internal data transfer times of the LioN-Safety IO-Link Master with a connected IO-Link Device as digital I/O extension (Belden article 0960 IOL 380-021 16DIO Hub with a minimum cycle time of 1 ms).

There are three measured data direction values for each use case:

- ▶ **PLC to DO:** Transfer of a changed PLC output data to IO-Link Device digital output.
- ▶ **DI to PLC:** Transfer of a changed digital input signal on IO-Link Device to PLC.
- ▶ **Round-trip time (RTT):** Transfer of a changed PLC output data to IO-Link Device digital output. The digital output is connected to an IO-Link Device digital input. Transfer of the changed digital input signal on IO-Link Device to PLC. $RTT = [PLC\ to\ DO] + [DI\ to\ PLC]$.

The measured values are taken from the ethernet data transmission line. The values are therefore without PLC processing times and PLC cycle time.

The configurable digital input filter value on 0960 IOL 380-021 was set to "off" (0 ms).

For calculation of user specific data transfer and round-trip times of possible input filters, PLC processing and cycles times must be taken into calculation.

The measured values are valid for a maximum of 48 bytes of IO-Link data for the IO-Link Master in each direction (Input/Output).

Use case 1:

IO-Link Master configuration with enabled Web interface and *disabled* IIoT protocols

Data direction	Data transfer time in ms		
	Minimum	Average	Maximum
PLC to DO	3.7	6.0	7.7
DI to PLC	1.1	3.0	4.3
RTT	6.1	8.9	11.1

Use case 2:

IO-Link Master configuration with enabled Web interface and *enabled* IIoT protocols

Data direction	Data transfer time in ms		
	Minimum	Average	Maximum
PLC to DO	7.7	10.0	13.4
DI to PLC	3.3	4.4	5.6
RTT	12.1	14.3	17.0

18 Recycling note



The symbol of a crossed-out wheeled bin shown on the device indicates that the device **MUST NOT** be disposed of with household waste at the end of its service life.

After its service life, the used device must be disposed of properly as electronic waste in accordance with the locally applicable disposal regulations.

End users are responsible for deleting personal data from the used device prior to disposal.

End users are obliged to separate used batteries and accumulators that are not enclosed by the used device from the used device in a nondestructive manner before disposing of the used device. The used batteries and accumulators must be handed in for separate collection. This does not apply if the used device is handed in for reuse.

19 Accessories

In order to get access to various types of accessories, please visit our Web page:

<https://www.belden.com>

20 Declarations of conformity



Lumberg Automation™ and Hirschmann™ Products



EC Declaration of Conformity

Manufacturer Belden Deutschland GmbH **Doc-Nr.:** CE_0439V00_
Hersteller **File:** CE_0439V00_.pdf

Address Im Gewerbepark 2
Adresse 58579 Schalksmühle

declares in sole responsibility, that the product(s):
erklärt in alleiniger Verantwortung, dass das/die Produkt(e):

Type Remote IO Module - Functional Safety - PROFIsafe
Typ

Product(s) 0980 SSL 3031-121-007D-101
Produkt(e)

comply with the requirements of the following European directive(s):
übereinstimmen mit den Vorschriften folgender/folgenden Europäischer Richtlinie(n):

2014/30/EU,
2011/65/EU,
2006/42/EG

The following standard(s) was(were) applied:

Folgende Normen wurden angewandt:

EN IEC 63000: 2018

IEC 61131-2: 2017

EN 61131-2: 2007

EN ISO 13849-1: 2023

Notified Body for certification
(EC type-examination) in accordance
with Annex IX of 2006/42/EG

Benannte Stelle für die Zertifizierung
(EG Baumusterprüfung) in Übereinstimmung
mit Anhang IX, 2006/42/EG:

TÜV Rheinland Industrie Service GmbH
Am grauen Stein
D-51105 Köln
Germany

Kenn-Nr. 0035
EC type-examination No.: 01/205/5982.00/24
EG-Baumusterprüfung Reg.-Nr.: 01/205/5982.00/24

Neckartenzlingen, den 07.08.2024

i.V. Jochen Dolezal
Director R&D

i.V. Sercan Suoelmez
Manager Quality

i.A. Gerald Lieb
R&D Engineer



Lumberg Automation™ and Hirschmann™ Products

EC Declaration of Conformity

Manufacturer Belden Deutschland GmbH **Doc-Nr.:** CE_0440V00_
Hersteller File: CE_0440V00_.pdf

Address Im Gewerbepark 2
Adresse 58579 Schalksmühle

declares in sole responsibility, that the product(s):
erklärt in alleiniger Verantwortung, dass das/die Produkt(e):

Type Remote IO Module - Functional Safety - PROFIsafe
Typ

Product(s) 0980 SSL 3030-121-007D-101
Produkt(e)

comply with the requirements of the following European directive(s):
übereinstimmen mit den Vorschriften folgender/folgenden Europäischer Richtlinie(n):

2014/30/EU,
 2011/65/EU,
 2006/42/EG

The following standard(s) was(were) applied:

Folgende Normen wurden angewandt:

EN IEC 63000: 2018

IEC 61131-2: 2017

EN 61131-2: 2007

EN ISO 13849-1: 2023

Notified Body for certification (EC type-examination) in accordance with Annex IX of 2006/42/EG	TÜV Rheinland Industrie Service GmbH Am grauen Stein D-51105 Köln Germany
Benannte Stelle für die Zertifizierung (EG Baumusterprüfung) in Übereinstimmung mit Anhang IX, 2006/42/EG:	Kenn-Nr. 0035 EC type-examination No.: 01/205/5982.00/24 EG-Baumusterprüfung Reg.-Nr.: 01/205/5982.00/24

Neckartenzlingen, den 07.08.2024

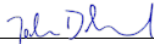
 i.V. Jochen Dolezal
 Director R&D

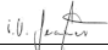
 i.V. Sercan Stoeelmez
 Manager Quality

 i.A. Gerald Lieb
 R&D Engineer