

**Table of Contents**

<b>1. Introduction</b>	<b>3</b>
1.1. Safety Precautions .....	3
1.2. Glossary .....	3
<b>2. Planning a System Layout</b>	<b>4</b>
<b>3. Fiber Routing</b>	<b>6</b>
3.1. Additional accessories required .....	6
3.2. Fiber routing into a single Cabinet .....	8
3.3. Fiber routing into a pair of Cabinets .....	11
A. Back to back (vertical routing) .....	11
B. Back to back (Diagonal or Crossed routing) .....	13
C. Side to side routing .....	16

---

<b>3.4. Fiber routing in a row of Cabinets.</b> .....	<b>17</b>
<b>A.In-Cabinet Channel Fiber Management</b> .....	<b>17</b>
<b>B.Rear-Channel Fiber Management</b> .....	<b>20</b>
<b>C. Inner-Channel &amp; Back-to-Back fiber Management</b> .....	<b>24</b>
<b>4. Fiber routing limits</b> .....	<b>28</b>
<b>4.1. Rear-Channel configuration limit</b> .....	<b>28</b>
<b>4.2. In-Cabinet Channels configuration limit.</b> .....	<b>29</b>
<b>4.3. Patch-Cord type and fiber density</b> .....	<b>30</b>

---

## 1. Introduction

This manual shows and provides complete instructions for:

- How to create and expand a DCX Cross-Connect System
- The available procedures how to route fibers into one and multiple Cabinets
- The required Patch-Cord length (depending on the quantity of Cabinets used)

### 1.1. Safety Precautions

 = General Information that is applicable in use of the DCX products family

 = Includes related warnings to prevent damage to equipment and/ or personal injury.

### 1.2. Glossary

**PC:** Patch Cord cable

**DX:** Duplex (used to describe the Patch Cord cable 1.6 mm Duplex)

**L:** Left Cabinet feed (used for planning a Cross-Connect System, **see page 28-29** for more details)

**L#:** Housing identified into a Left Cabinet (used to determine a specific routing path besides the available fiber routing configurations)

**R:** Right Cabinet feed (used for planning a Cross-Connect System, **see page 28-29** for more details)

**R#:** Housing identified into a Right Cabinet (used to determine a specific routing path besides the available fiber routing configurations)

**PCSM:** Patch Cord Slack Module Accessory.

## 2. Planning a System Layout

This section shows all available methods for expanding a DCX Cross-Connecting system.

The possible methods to create a DCX Cross-Connect system is by installing different Cabinets in a row, Side by Side. The Cross-Connection is made when there are two Cabinets with opposite feeds (**L-R** ↔ **R-L**).

**NOTE:** For more information on how to fix or group Cabinets together, refer to the Quick Start Guide **PX106859** available at our microsite: [www.belden.com/dcx](http://www.belden.com/dcx)

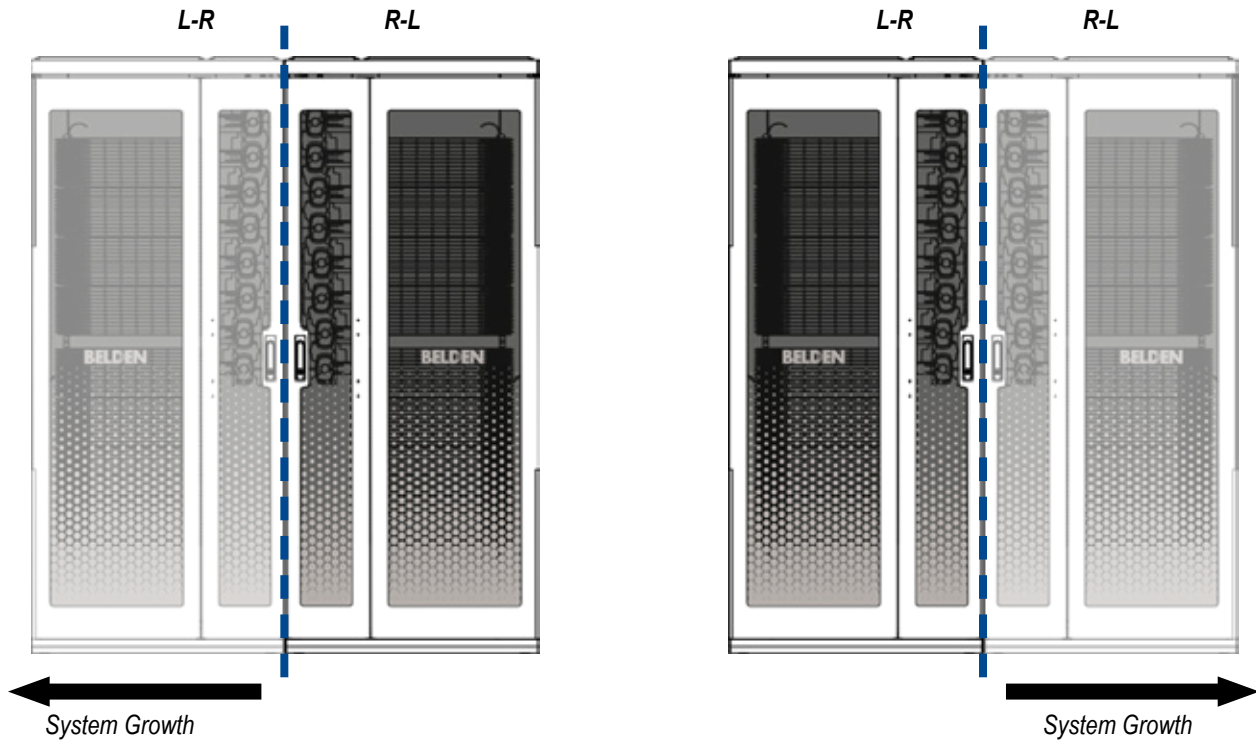

The opposite Cabinets that are grouped together form a different pair.

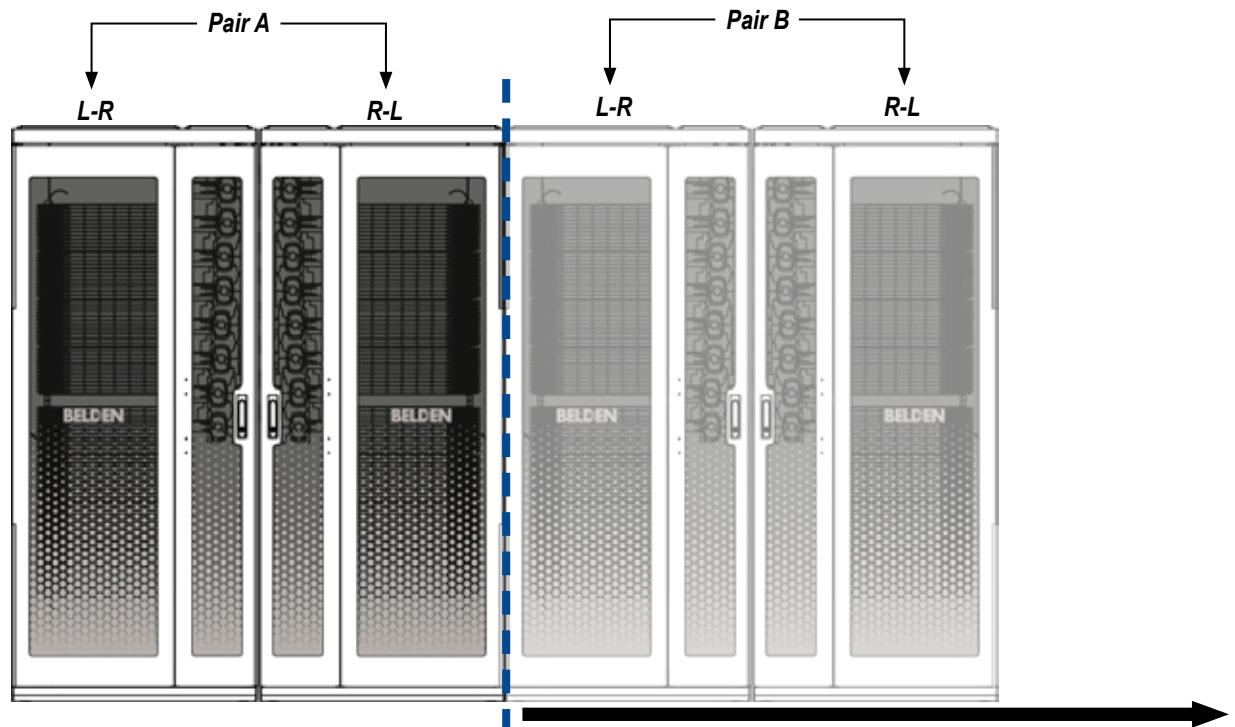

To load completely a Cabinet it takes 4608 fibers.  
By going to another Cabinet if this Patch Cord capacity pass in the same horizontal rear channel the fibers could go up to **six pairs of Cabinets** installed in the same row.

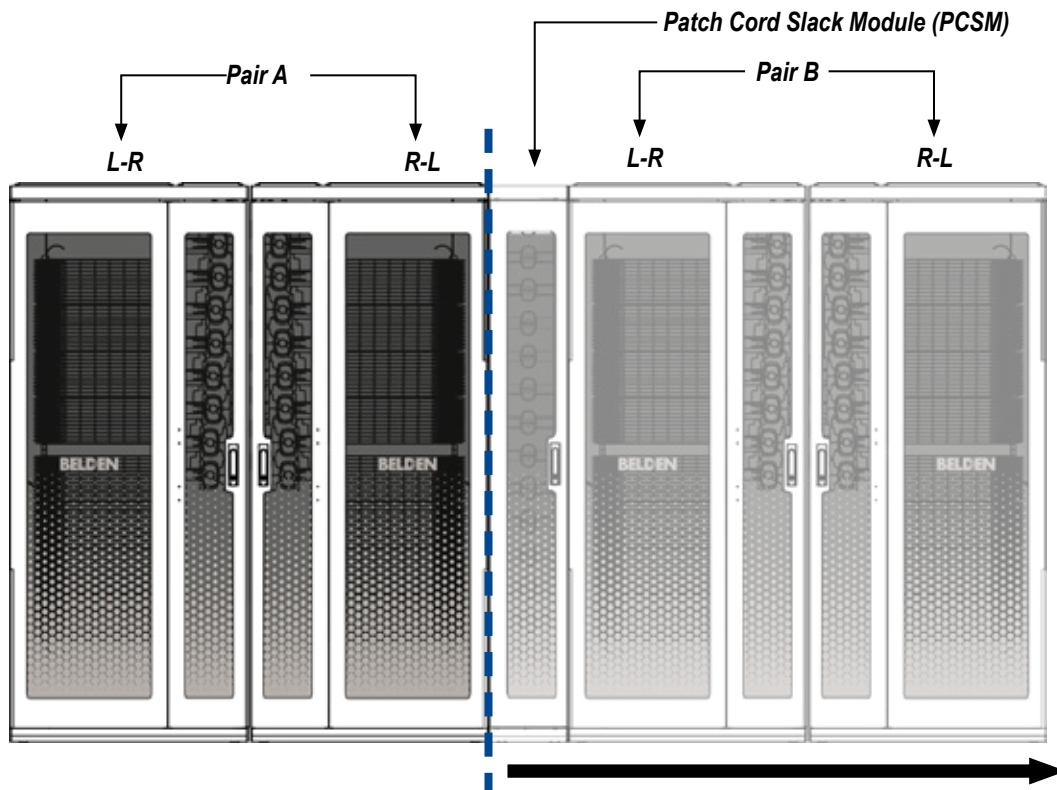

To load completely a Cabinet it takes 4608 fibers.  
 By going to another Cabinet if this Patch Cord capacity pass in the same horizontal **inner channel** the fibers could go up to **six pairs of Cabinets** installed in the same row.

It is possible to Cross-Connect rows of Cabinets when they're placed at Back-to-Back.

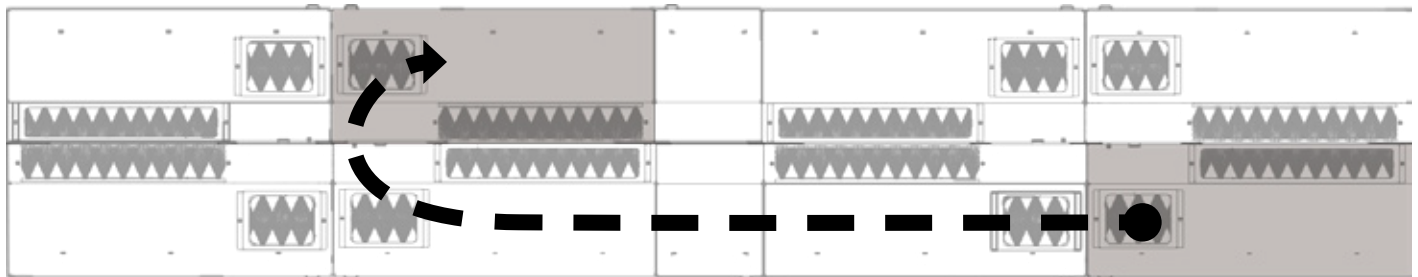

● → = Example of a routing path which Inter-Connects Cabinets

### 3.Fiber Routing

This section shows the recommended procedures on how to pass Patch-Cord fibers (P-C) inside a single or multiple DCX Cabinet.

#### 3.1.Additional accessories required:

- To route fibers on all available configurations (**sections 3.2 to 3.4**)

DCX PatchCord Telescopic Spool  
**DCX-SPOO-KIT02W**

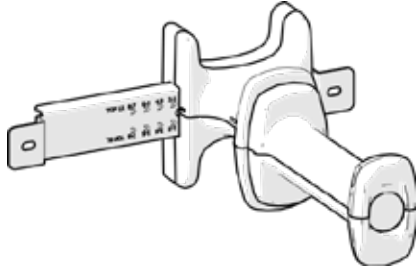

- To route fibers that pass inside a row of Cabinets (**section 3.4.A.**)

DCX Horizontal In-Cabinet Channel Kit  
**DCX-HINC-KIT01x**

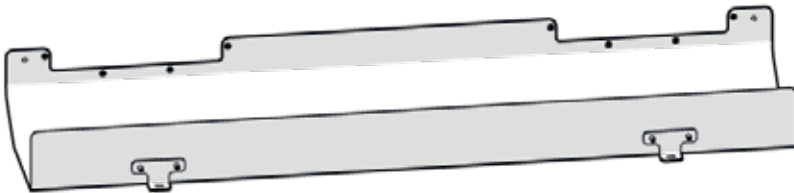

DCX Horizontal In-Cabinet Short Channel Kit (For End Cabinet)  
**DCX-HINC-KIT02x**

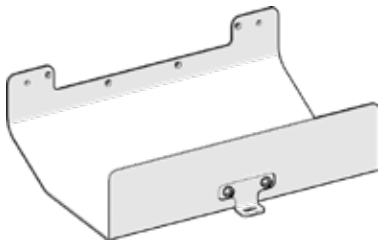

DCX Patch Cord Storage Module  
**DCX-PCST-MOD01x**

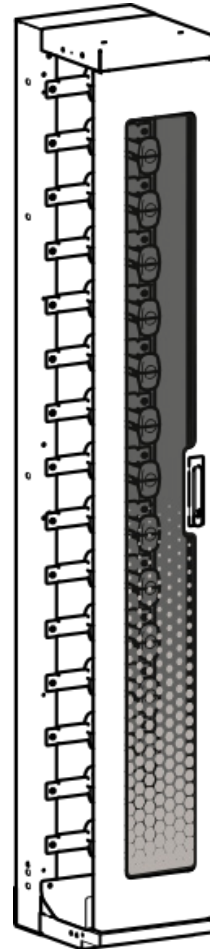

### 3.1. ADDITIONAL ACCESSORIES REQUIRED (CONTINUED)

---

- To route fibers that pass behind a row of Cabinets (**section 3.4.B.**)

DCX Horizontal Rear Channel (4x) Left to Right

**DCX-HRRC-LR01Bx**

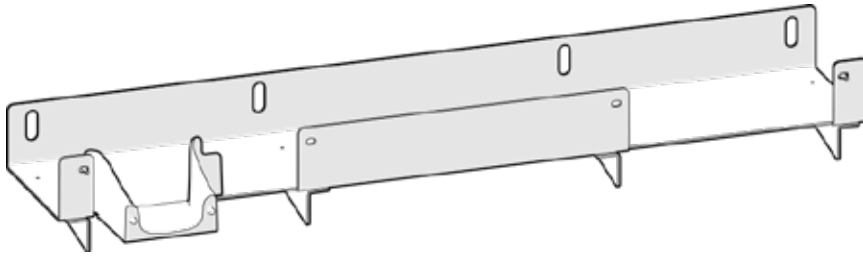

DCX Horizontal Rear Channel (4x) Right to Left

**DCX-HRRC-RL01x**

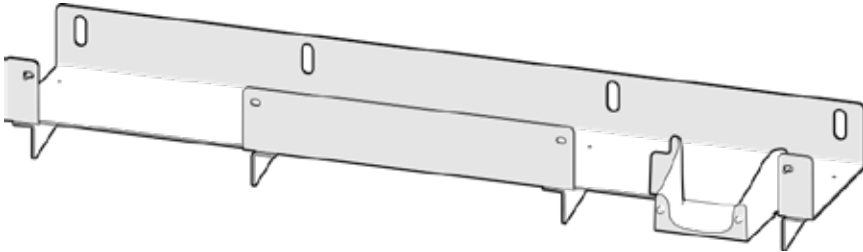

- To route fibers that pass inside rows of Cabinets placed **Back-to-Back** (**section 3.4.C.**)

DCX Horizontal In-Cabinet Front-to-Back Patch Cord Bridge (2x)

**DCX-HINB-KIT01B**

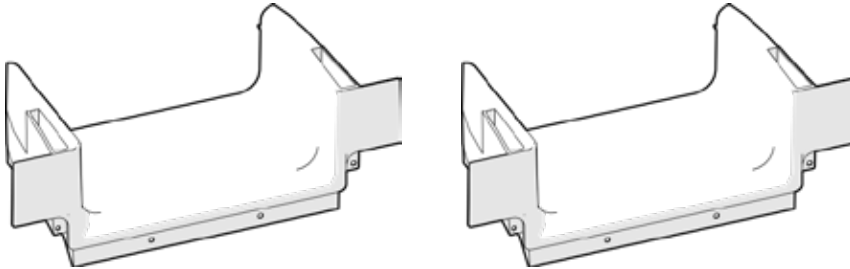

**NOTE:**Each accessory comes with a print document that mentions the installation procedures. The Quick Start Guide documents are also available at our mircosite [www.belden.com/dcx](http://www.belden.com/dcx)

### 3.2 Fiber routing into a Single Cabinet

To create a Cross-Connection inside the same Cabinet, the recommended Patch Cord (PC) length to connect between 2 points is **3.5m** ( $\approx 11.5'$  - 138").

1. Before installing all PC on the Housing Trays, begin to determine a connecting path.

**NOTE:** In this configuration, it is recommended that the connecting paths are determined from Top (**Housing 1,2,3,4**) to Bottom (**Housing 5,6,7,8**) or the opposite (from Bottom to Top).

Spools associated for Housings 1 and 2 are at the same horizontal position on the brackets, same goes for 3-4, 5-6 and 7-8.

#### STARTING POINTS

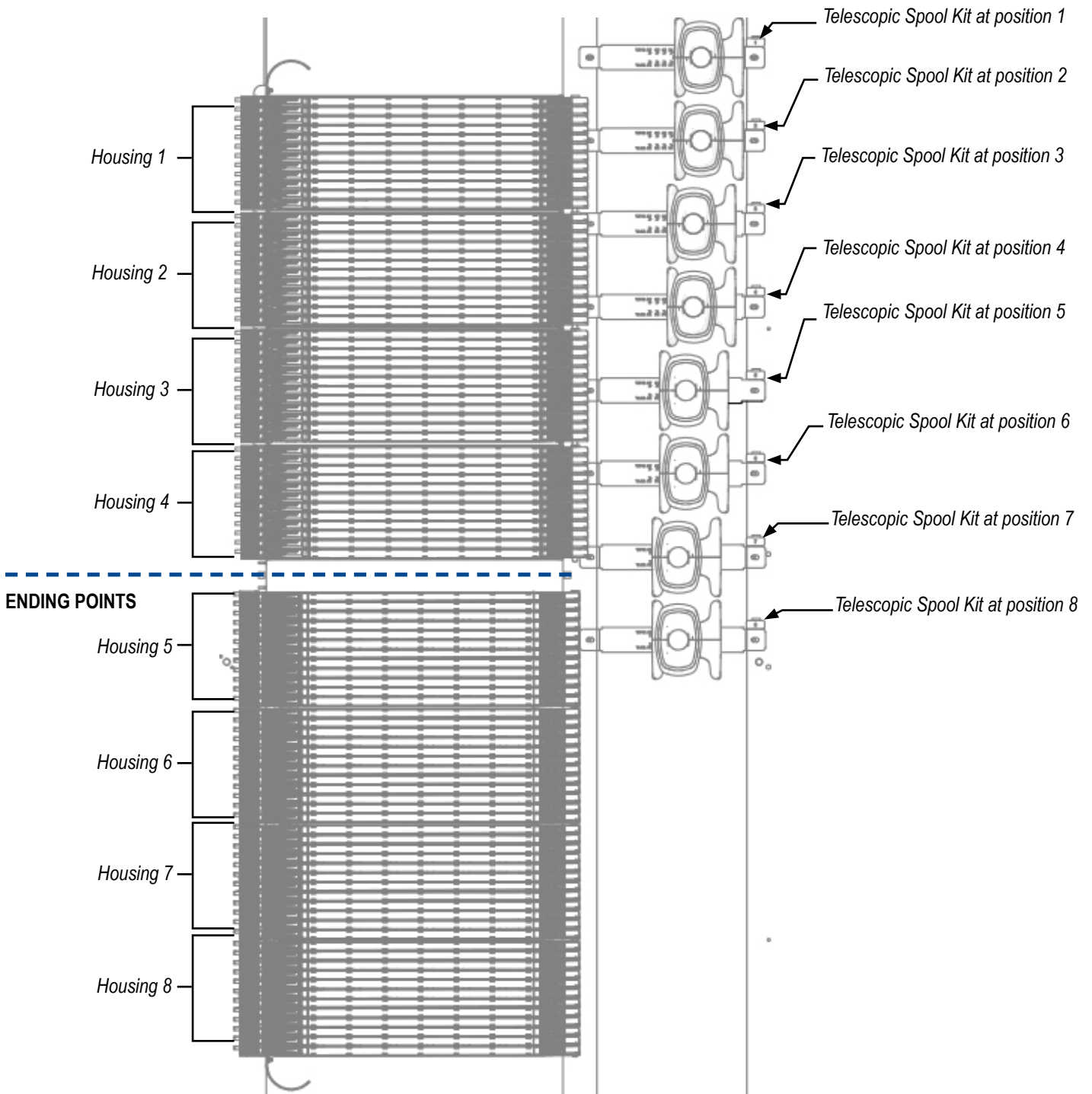



### 3.2 FIBER ROUTING INTO A SINGLE CABINET (CONTINUED)

2. At the Starting point, begin by loading the Tray of the selected Housing.  
Mate the **PC** ends in their respective places and set the Tray to its closed position.  
Place the **PC** fibers to the associated Spool and repeat the same procedures to load the remaining Trays.  
Once the Housing Trays are loaded set the Telescopic Spool to its neutral position.
- i** When opening a Housing Tray, the Telescopic Spool can be extended to procure the necessary Patch Cord Slack for the Tray movement.  
The Telescopic Spool is extended by pushing the Spool Button and pulling the External Slider forward.

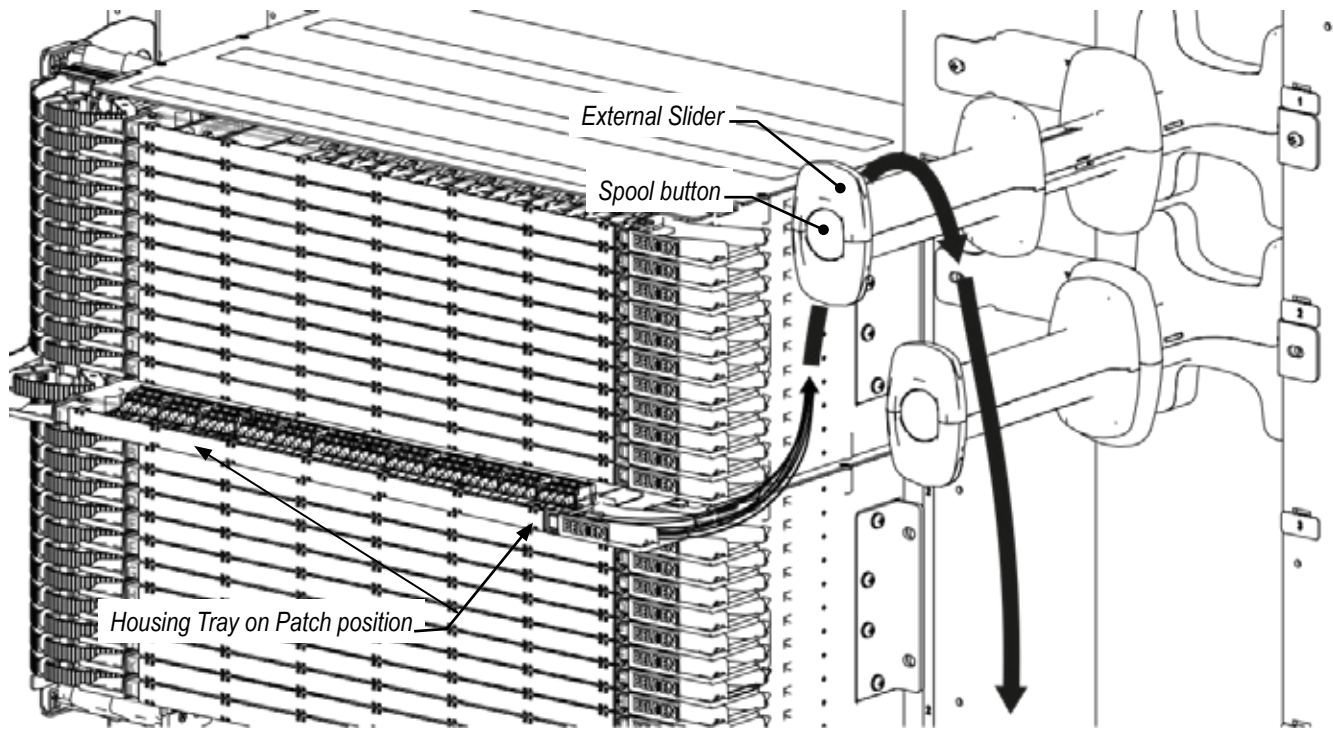

### 3.2 FIBER ROUTING INTO A SINGLE CABINET (CONTINUED)

3. Repeat the previous steps at the ending points (or opposite Housing) to complete the Cross-Connection

**NOTE:** The example below show a Cross-Connection between the **Housing 1** to the **Housing 5**.

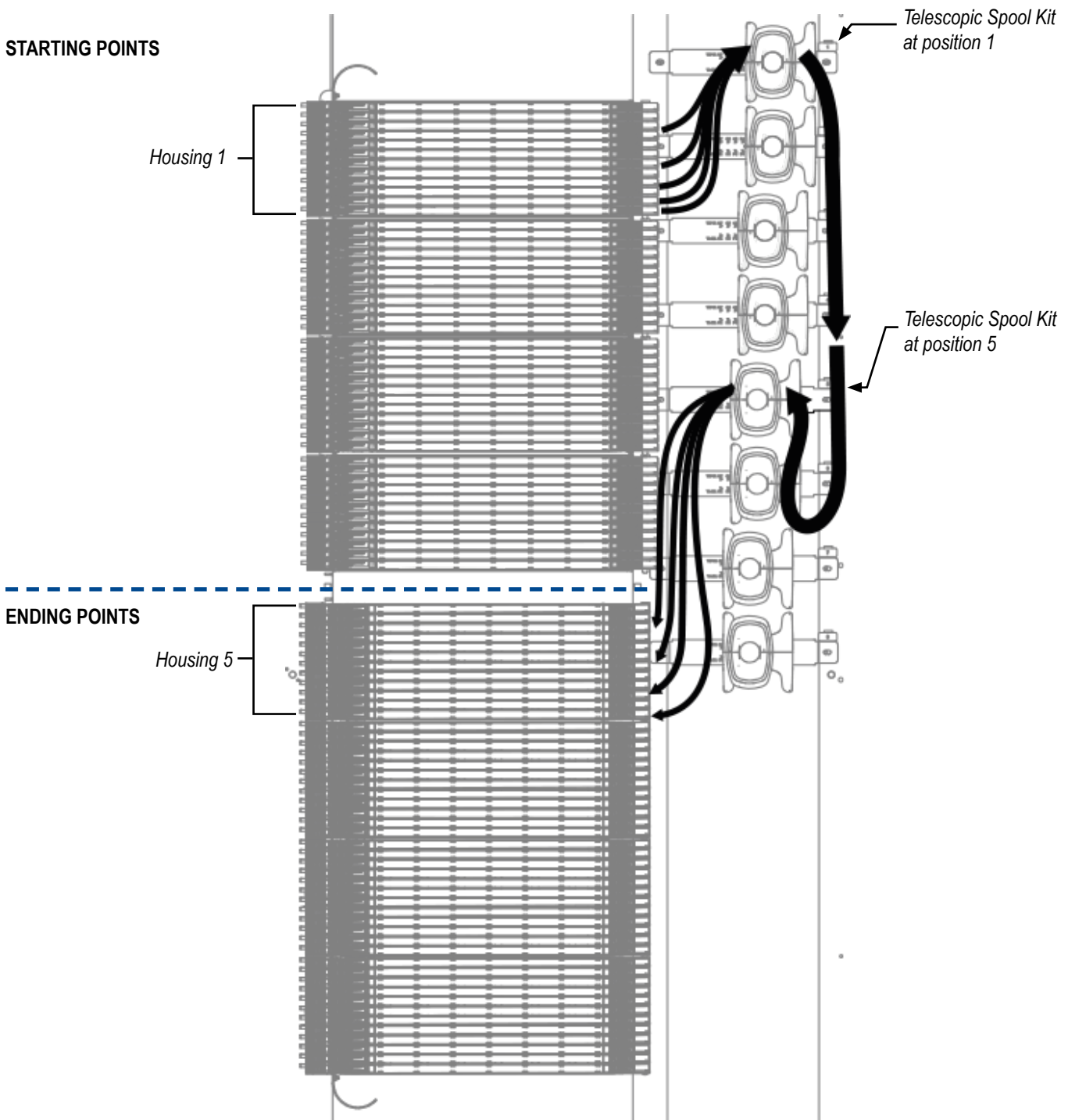

### 3.3. Fiber routing into a pair of Cabinets

The following configurations use the same Patch-Cord length (3.5 m or 11.5' - 138") as the previous one.

#### TOP VIEW

A. Back-to-Back configuration  
(Vertical Routing)

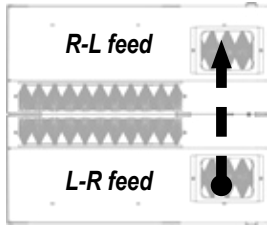

B. Back-to-Back configuration  
(Diagonal or Crossed Routing, refer page 13)

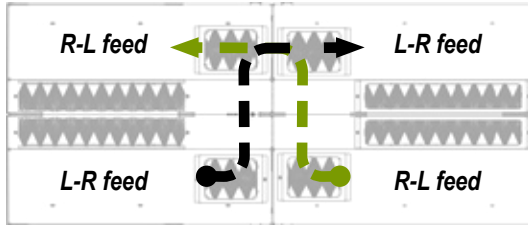

C. Side by Side configuration  
(refer page 16)

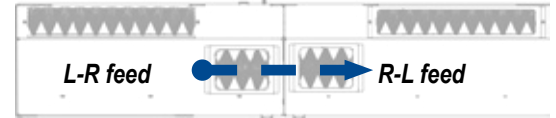

#### A. Back to back (vertical routing)

1. Refer to the blank template (or image below) to determine a connecting path.

**NOTE:** The Cabinets shown are presented side to side for visual clarity purposes only.  
The accurate orientation for starting (front) and ending (rear) points are as the top view (A.) shows.

#### FRONT:

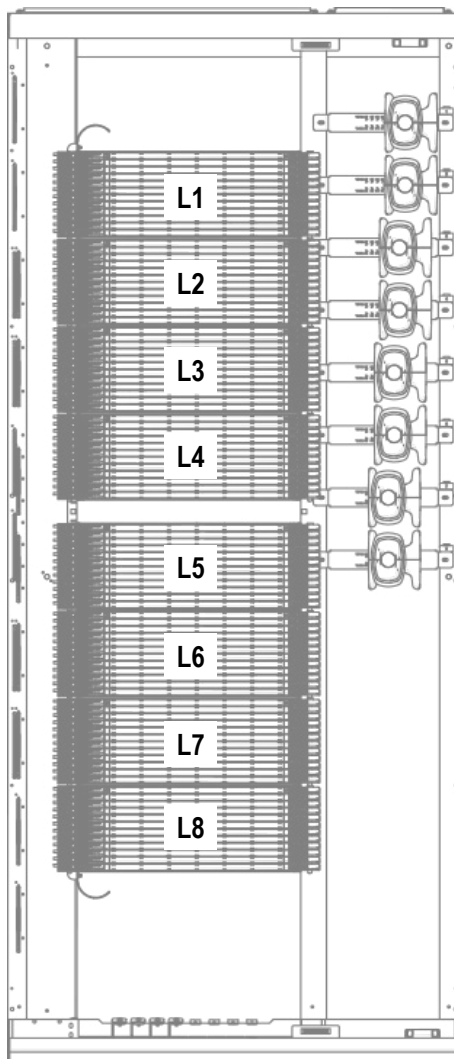

#### REAR

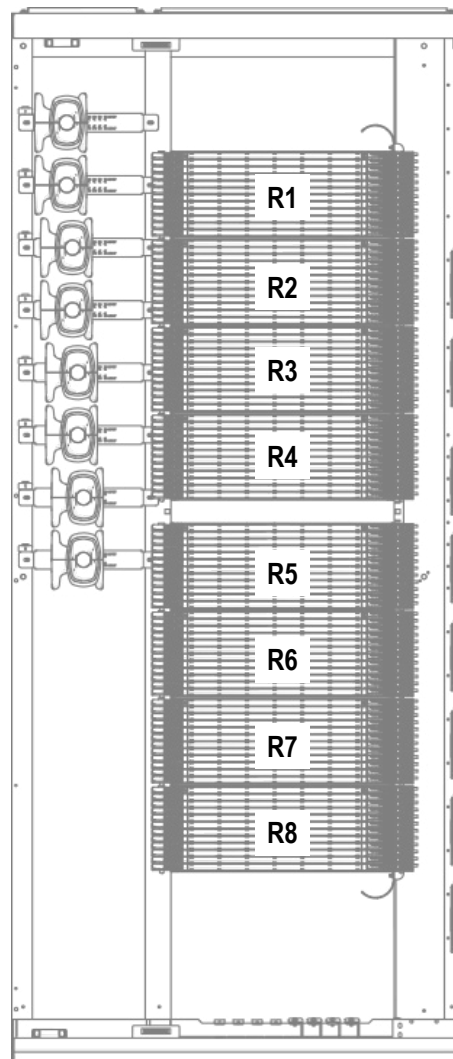

2. Once the last Tray (of the selected Housing) is loaded, set the Tray on its closed position and place the **PC** fibers on its respective spool. Pass the **PC** fibers through the back of the cabinet and when the fibers arrive to the opposite Housing, repeat the previous procedure to connect the Patch Cord ends to their respective place.

STARTING POINTS (L)

ENDING POINTS (R)

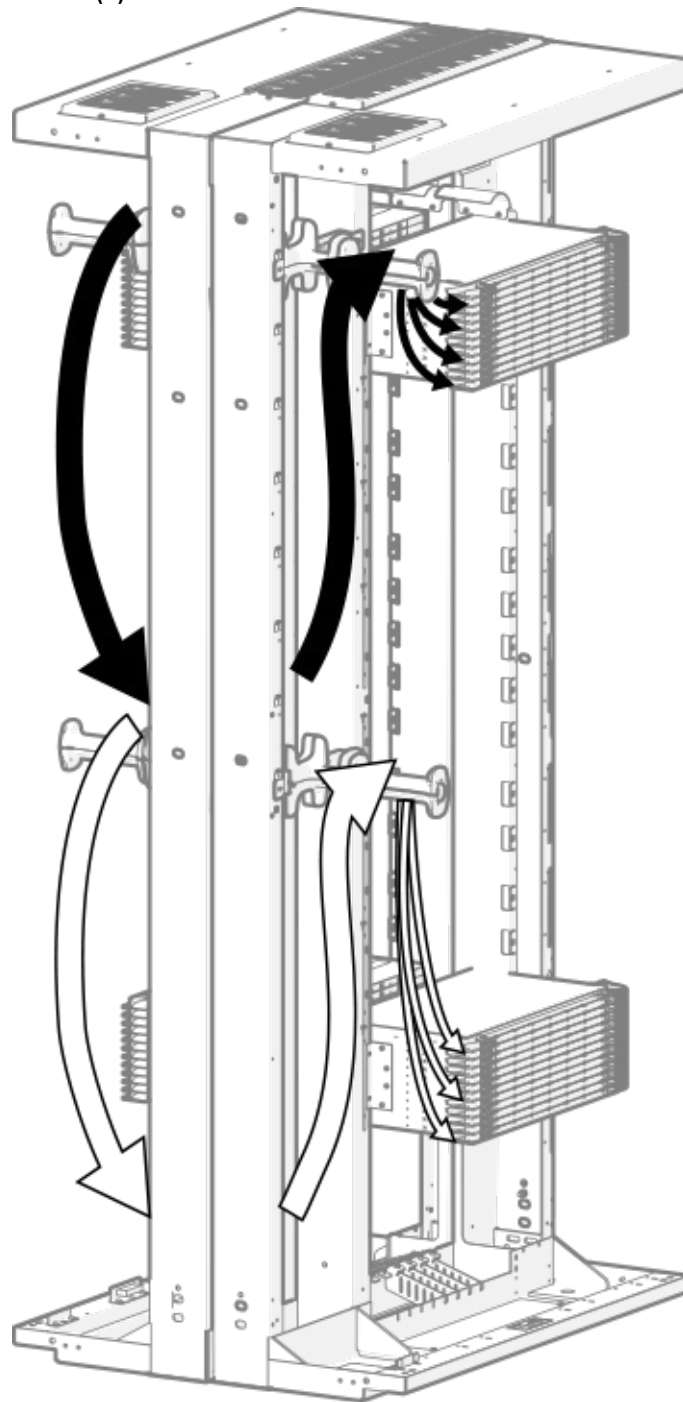

**Connecting paths chosen:**

- L1 → R1
- L8 → R8

## B. Back to back (Diagonal or Crossed routing)

1. Refer to the image (or blank template below) to determine a connecting path.

**NOTE:** For this configuration:

- The (front) Starting Points are the pair of Cabinets **A**
- The (rear) Ending Points are pair of Cabinets **B**

As the previous section, to see the accurate orientation for starting (front) and ending (rear) points refer to the top view (B.) of the **page 11**.

FRONT (A)

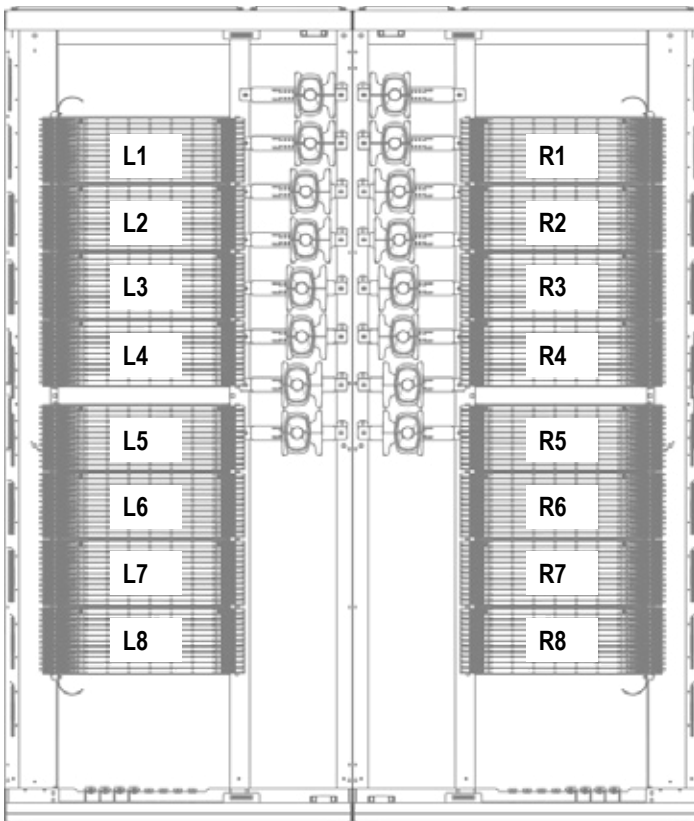

REAR (B)

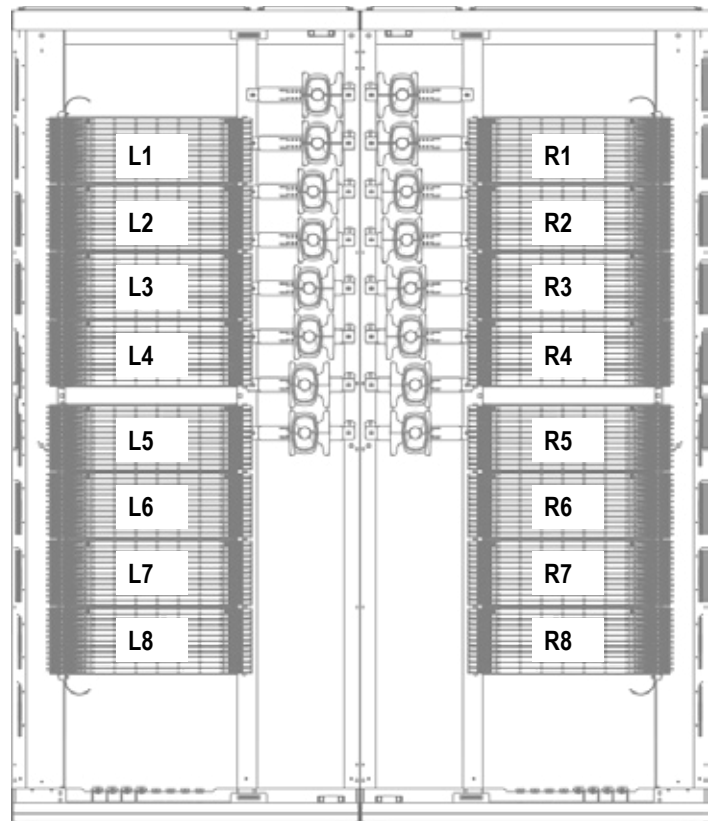

Connecting paths chosen (see page 14 to 15):

- A.R1 → B.L1
- A.L8 → B.R8

### 3.3.B. BACK TO BACK (DIAGONAL OR CROSSED ROUTING - CONTINUED)

2. Once the last Tray (of the selected Housing) is loaded, set the Tray on its closed position and place the **PC** fibers to the associated Spool.  
Pass the **PC** fibers through the back of the cabinet and when the fibers arrive in the opposite Housing, repeat the first procedure to connect the **PC** ends in their respective locations.

**NOTE:** On the images shown the Telescopic Spools and Housings are hidden to show the **PC** routing.

**Connecting paths chosen:**

- **A.R1** → **B.L1**
- **A.L8** → **B.R8**

FRONT

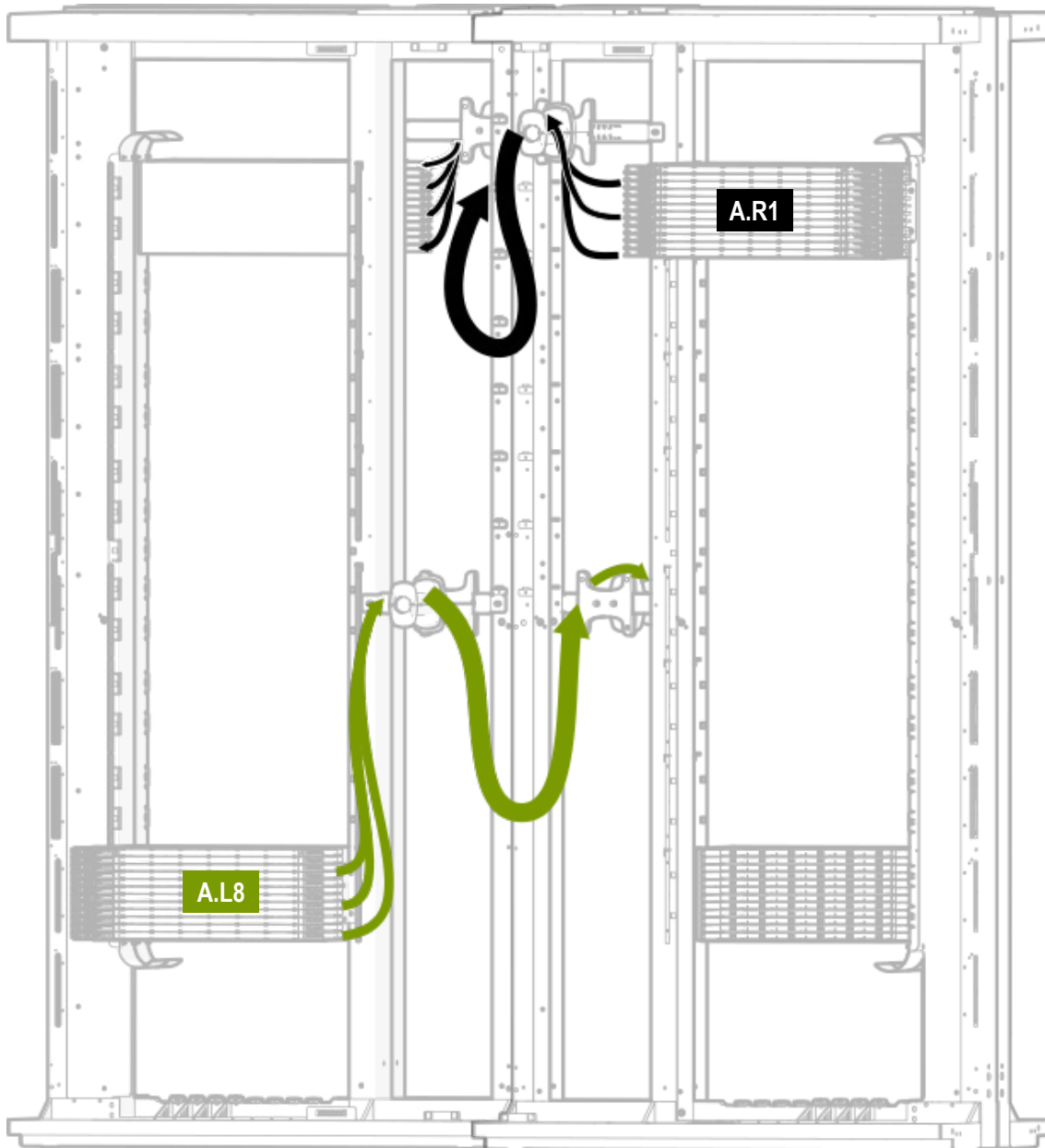

### 3.3.B. BACK TO BACK (DIAGONAL OR CROSSED ROUTING - CONTINUED)

3. Pass the **PC** fibers through the back of the cabinet and when the fibers arrive in the opposite Housing, repeat the first procedure to connect the **PC** ends in their respective locations.

**NOTE:** On the images shown the Telescopic Spools and Housings are hidden to show the **PC** routing.

Connecting paths chosen:

- A.R1 → B.L1
- A.L8 → B.R8

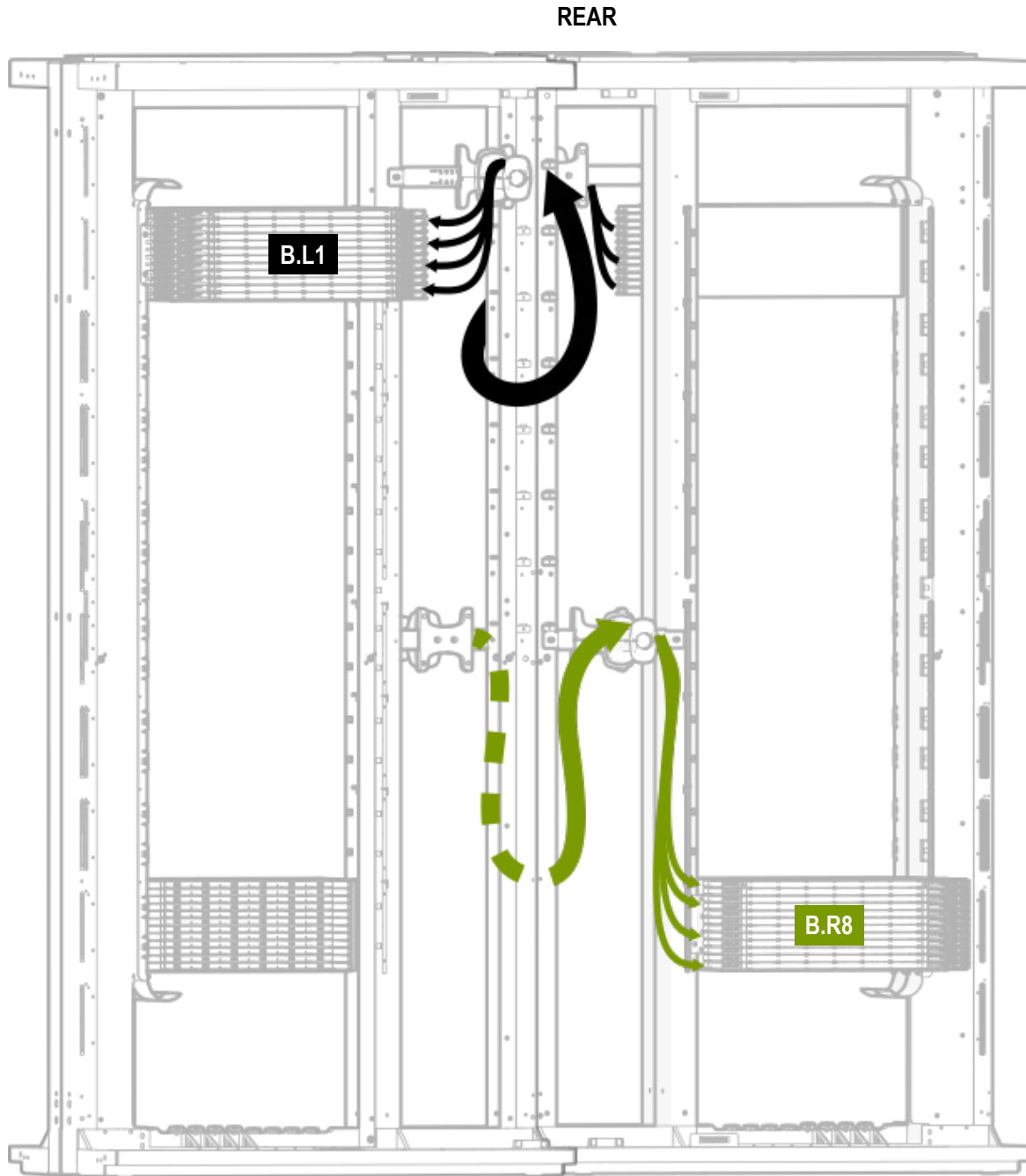

### C. Side to side routing

1. Refer to the blank template (or image) below to determine a connecting path.

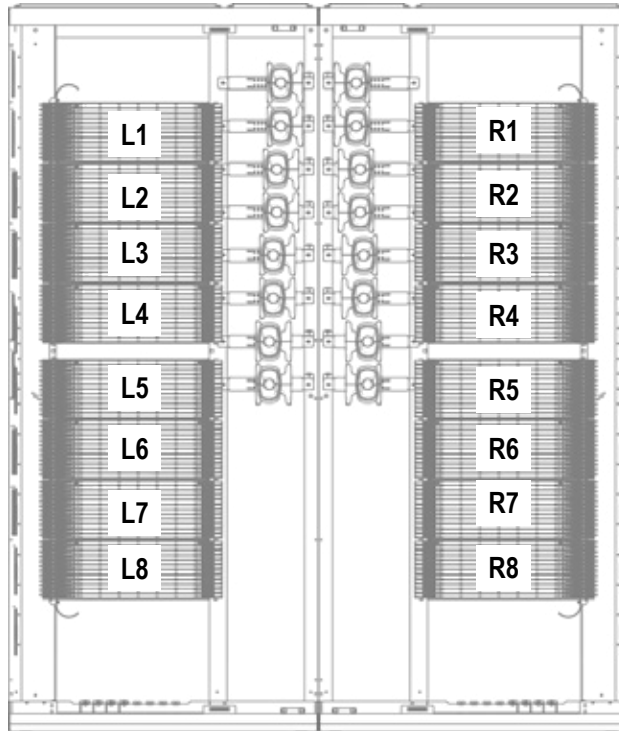

2. Once the last Tray (of the selected Housing) is loaded, set the Tray on its closed position and place the **PC** fibers on the associated Spool. Repeat the previous procedures to secure the opposite Patch Cord ends into their respective locations.

**NOTE:** For this configuration the connected fibers must be placed on the two Telescopic Spools to create a slack loop.

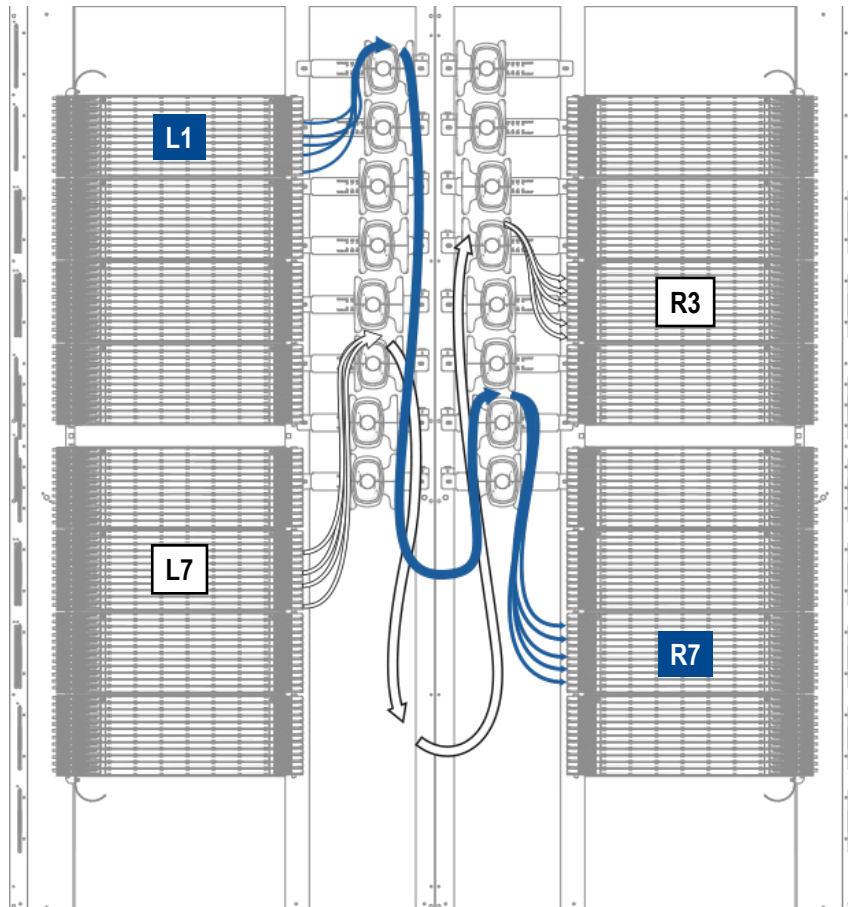



### 3.4. Fiber routing in a row of Cabinets

Each configuration (of this section) will show the procedures of how to route fibers in two pairs of Cabinets. For more details about the Patch Cord length to route in more Cabinets, please refer to the **section 4.1**.

#### A. In-Cabinet Channel Fiber Management

This configuration is recommended when Cabinets are installed next to (or behind) a wall and the Patch Cord length required is **7.5m (≈ 24.6' or 295¼")**.

1. Refer to the blank template (or image) below to determine a connecting path..

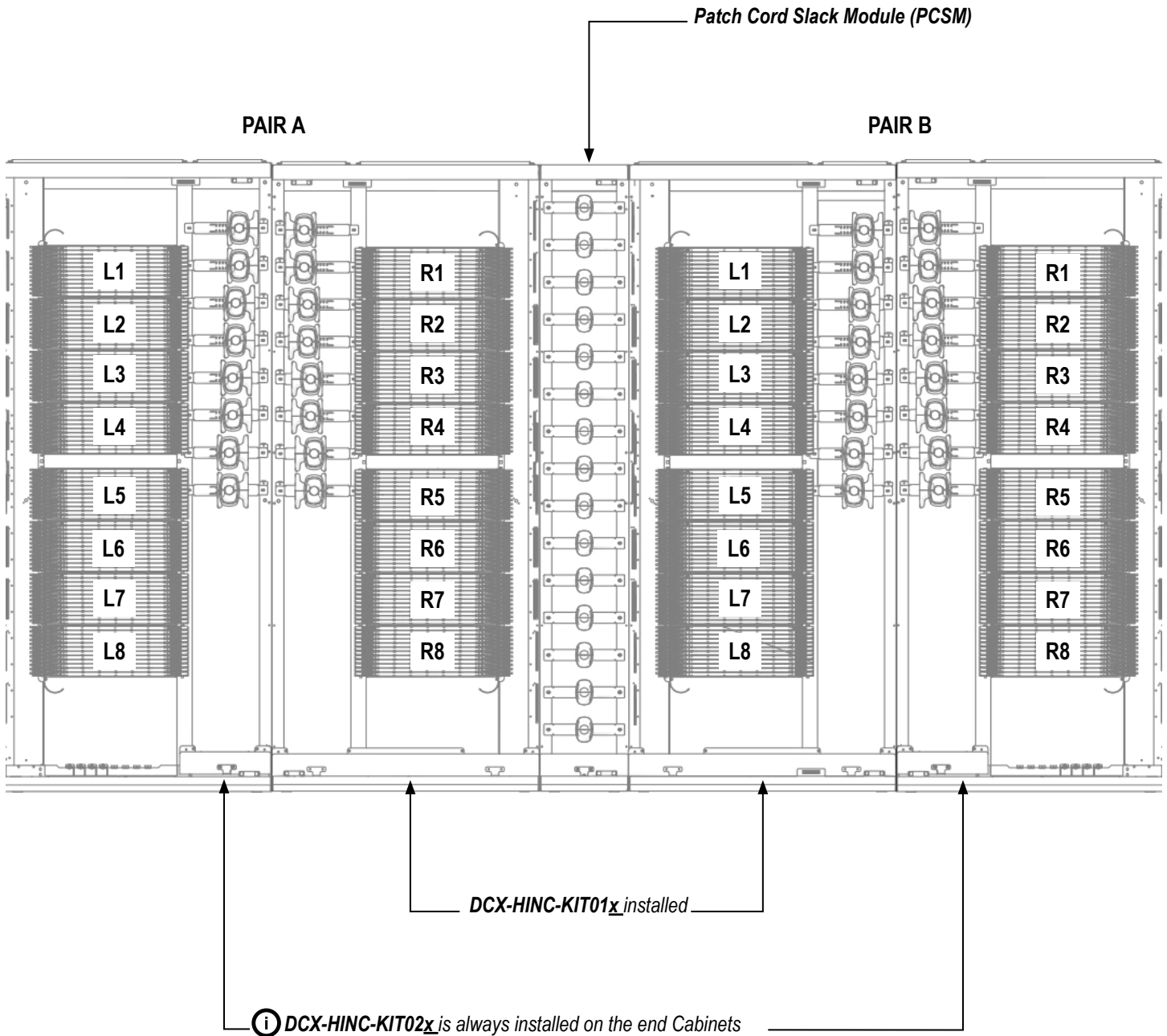

### 3.4.A. IN-CABINET CHANNEL FIBER MANAGEMENT (CONTINUED)

1. Once the last Tray (of the selected Housing) is loaded, set the Tray on its closed position and place the **PC** fibers to the associated Spool.

Let the fibers down and place them on the in-Cabinet Channels.

When the fibers arrive in the opposite Housing, repeat the first procedure to connect the opposite Patch Cords ends in their respective locations.

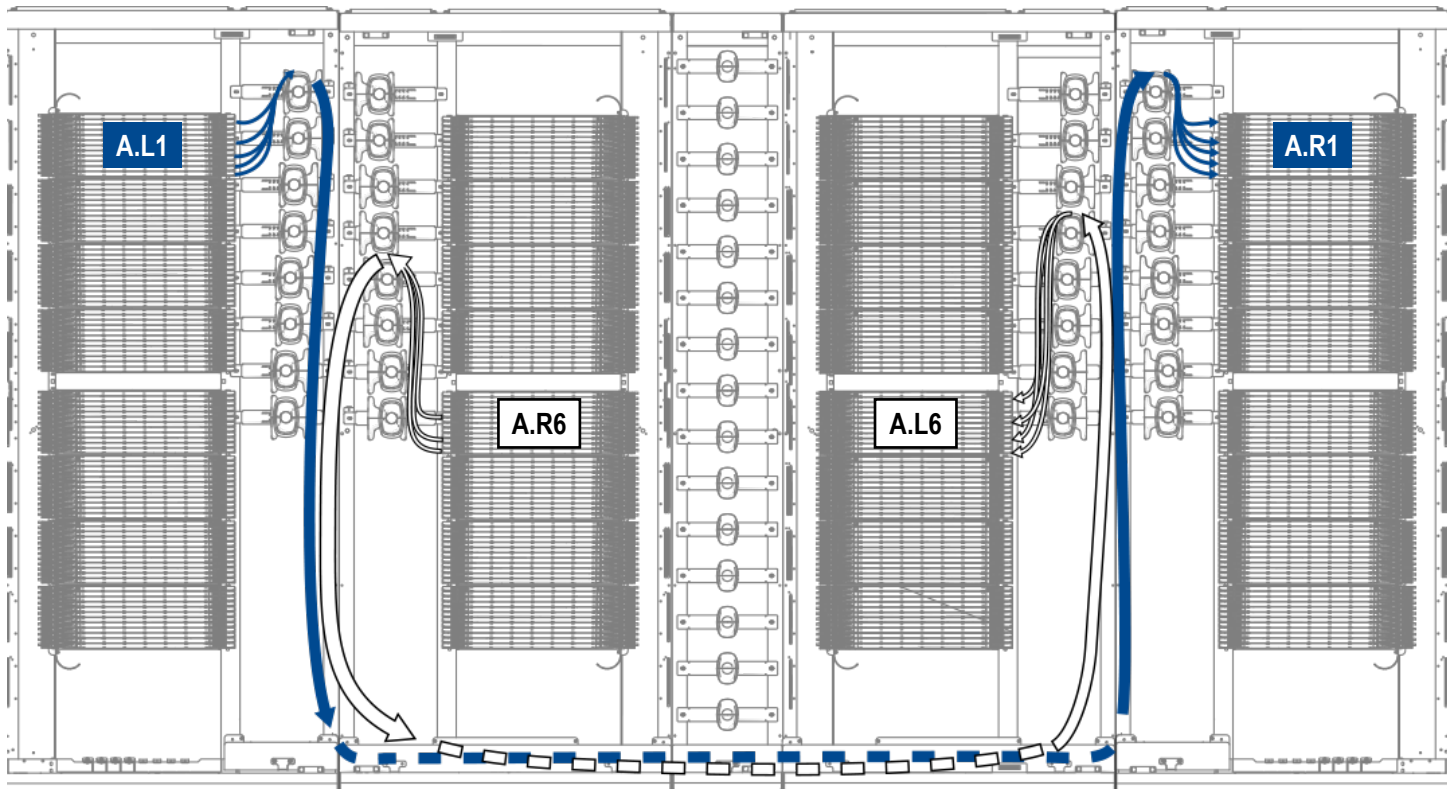

### 3.4.A. IN-CABINET CHANNEL FIBER MANAGEMENT (CONTINUED)

2. Once the Patch Cords ends are secured on both sides, take the fibers and place them on the Slack Spools located in the **PCSM**.

**i**: The location to place the fibers on the **PCSM** varies on the routing path chosen and (compared to the Cabinets) there's not an associated spool which specifies where to place fibers.

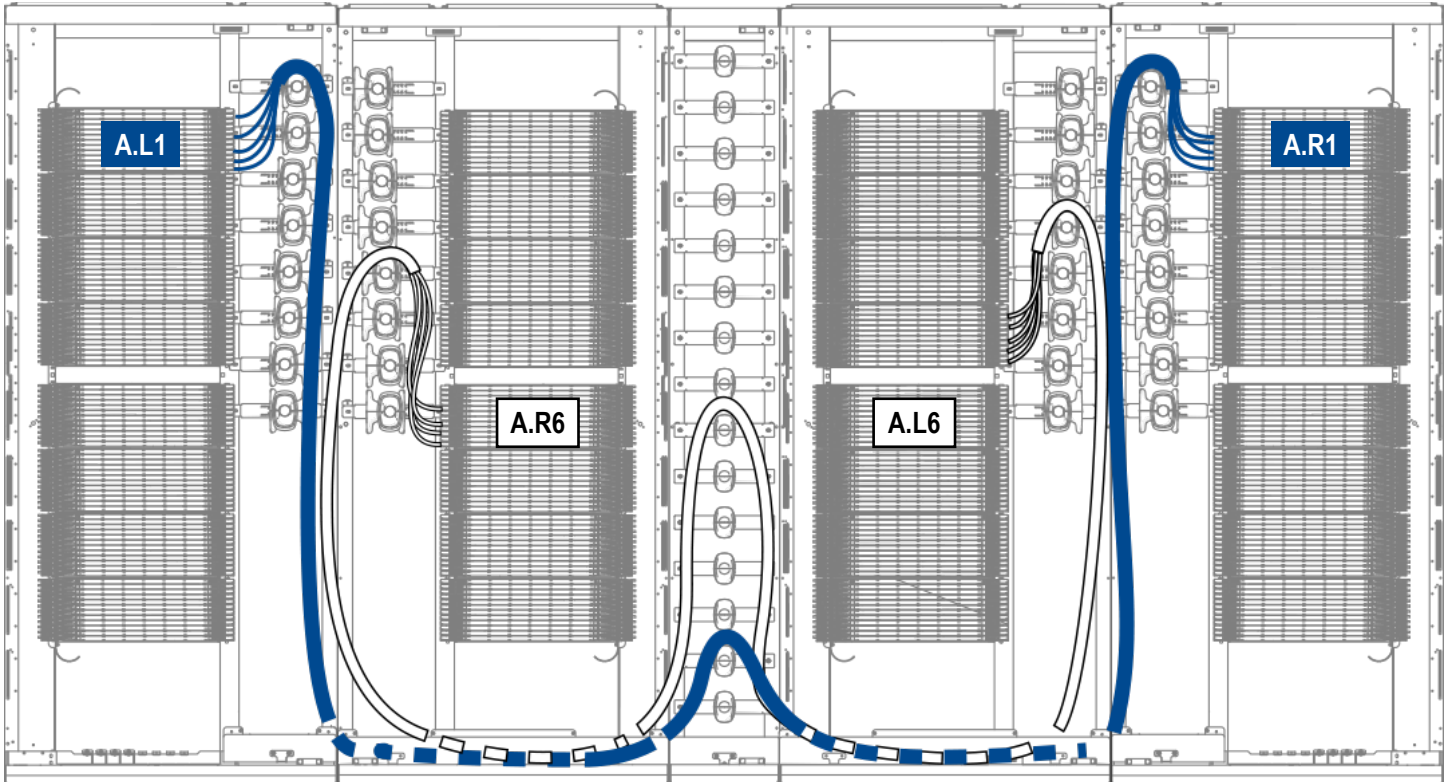

**B.Rear-Channel Fiber Management**

On this example, the fiber Patch Cord length used is **7.5m (≈ 24.6' or 295¼")**

1. Refer to the information below (blank template and table) to determine a connecting path.

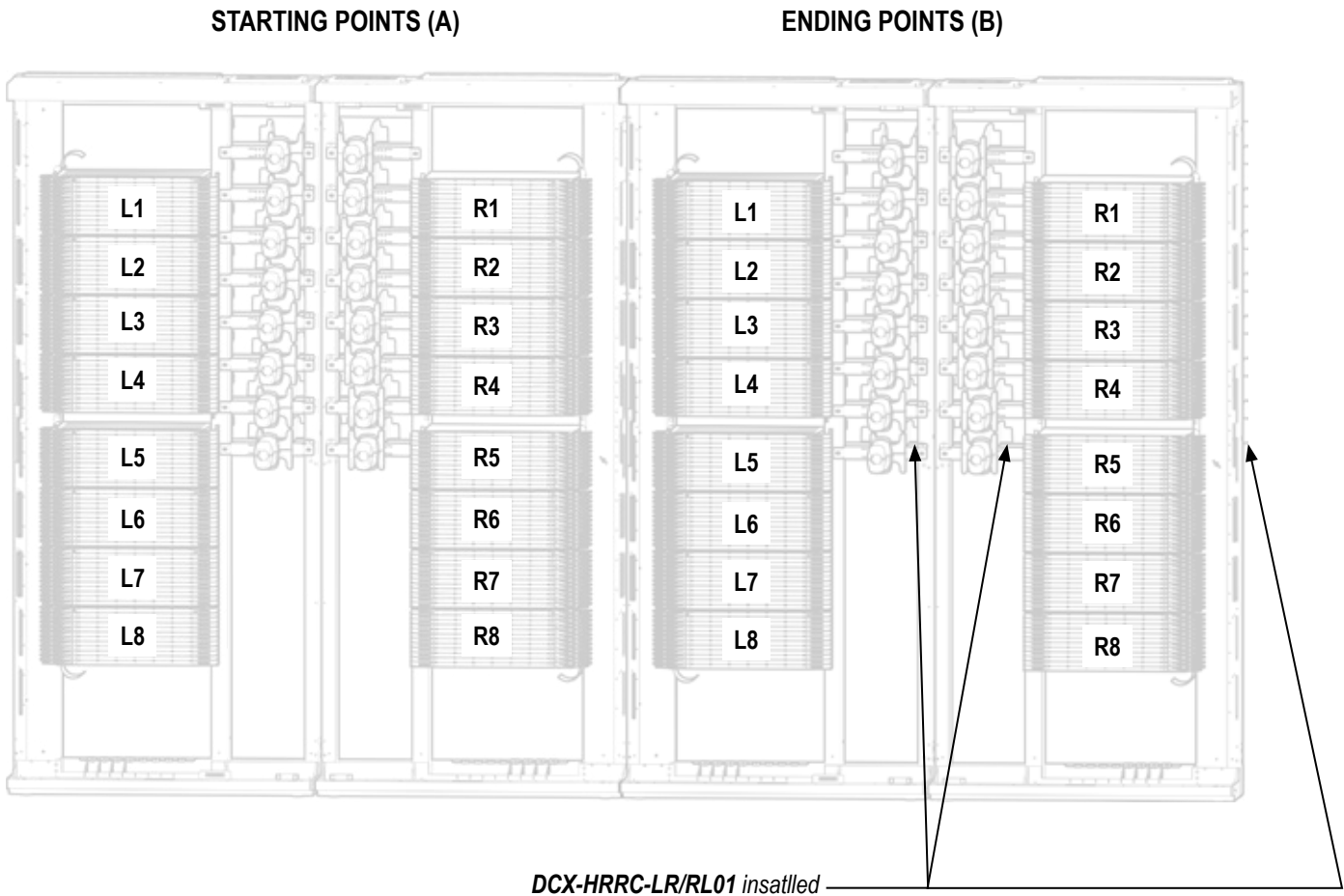

		Ending Points: B.							
		1	2	3	4	5	6	7	8
Starting Points : A.	/Housing Selected (L/R)								
	1	1	1	2	2	3	3	4	5
	2	1	2	2	3	3	4	4	5
	3	2	2	3	3	4	5	5	6
	4	2	3	3	4	4	5	6	6
	5	3	3	4	5	5	6	6	7
	6	3	4	4	5	6	6	7	7
	7	4	5	5	6	6	7	7	8
8	4	5	6	6	7	7	8	8	

**NOTE:** The numbers shown into the white cells represent the Rear-Channels where to place the **PC** fibers.

### 3.4.B. REAR CHANNEL FIBER MANAGEMENT (CONTINUED)

1. Once the last Tray (of the selected Housing) is loaded, set the Tray on its closed position and place the **PC** fibers to the associated Spool. Let the fibers down and place them at the rear of the selected Spool.

**Connecting paths chosen:**

- **A.L1** → **B.R1**
- **A.R8** → **B.L4**

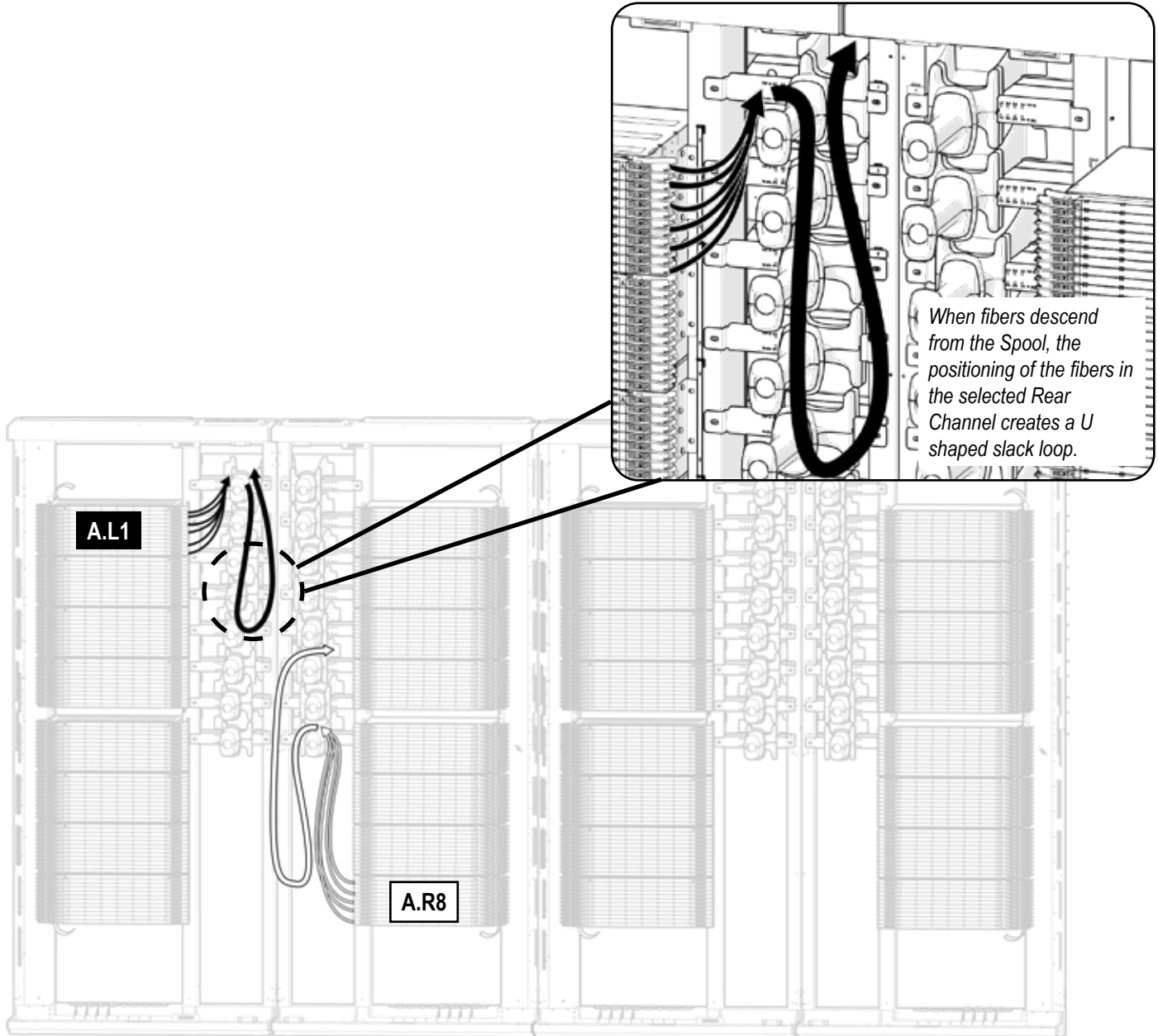

2. Pass the fibers to the end of the Rear Channel.

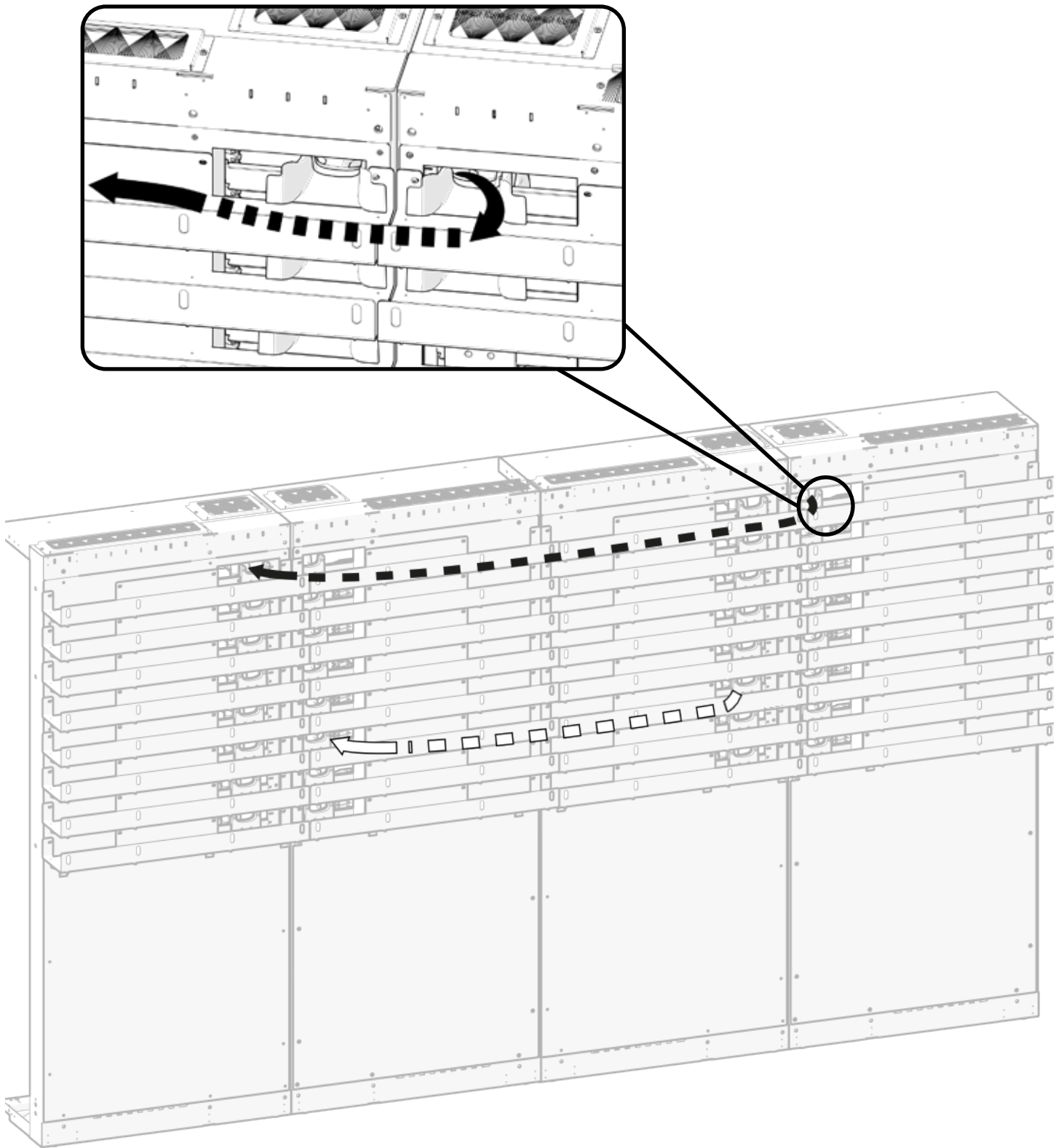

3. Repeat the previous steps shown to load the opposite Housing (or ending points).

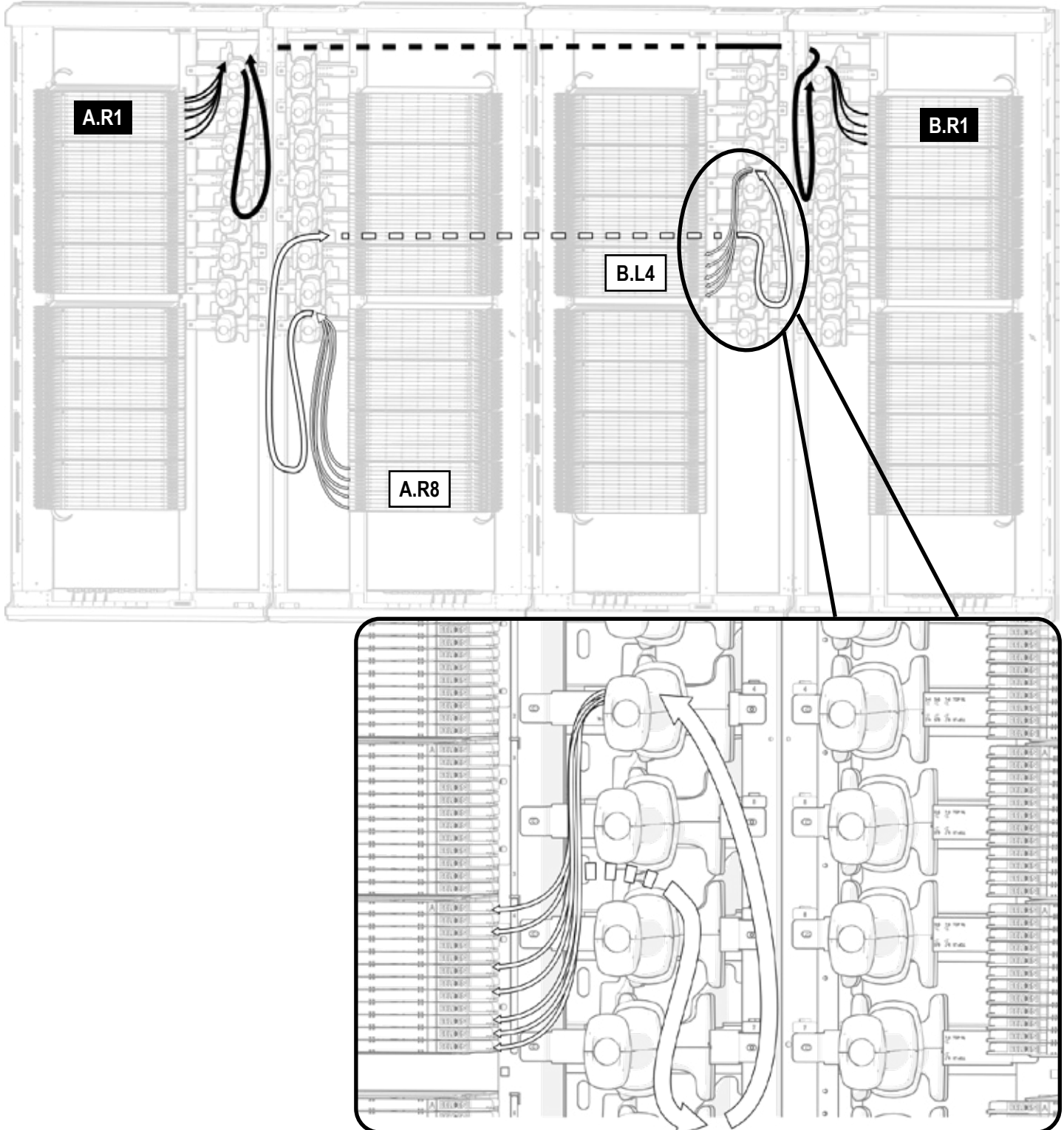

### C. Inner-Channel & Back-to-Back fiber Management

This configuration combines both of the previous configurations shown (at **pages 19 to 24**).  
The fiber Patch Cord length used for this example is **7.5m (≈ 24.6' or 295¼")**.

1. Refer to the blank templates (or images below) to determine a connecting path.

**NOTE:** The Cabinets pairs are presented on the same side for visual clarity purposes only, to see the accurate view of this configuration refer to the top view of the **page 5**.

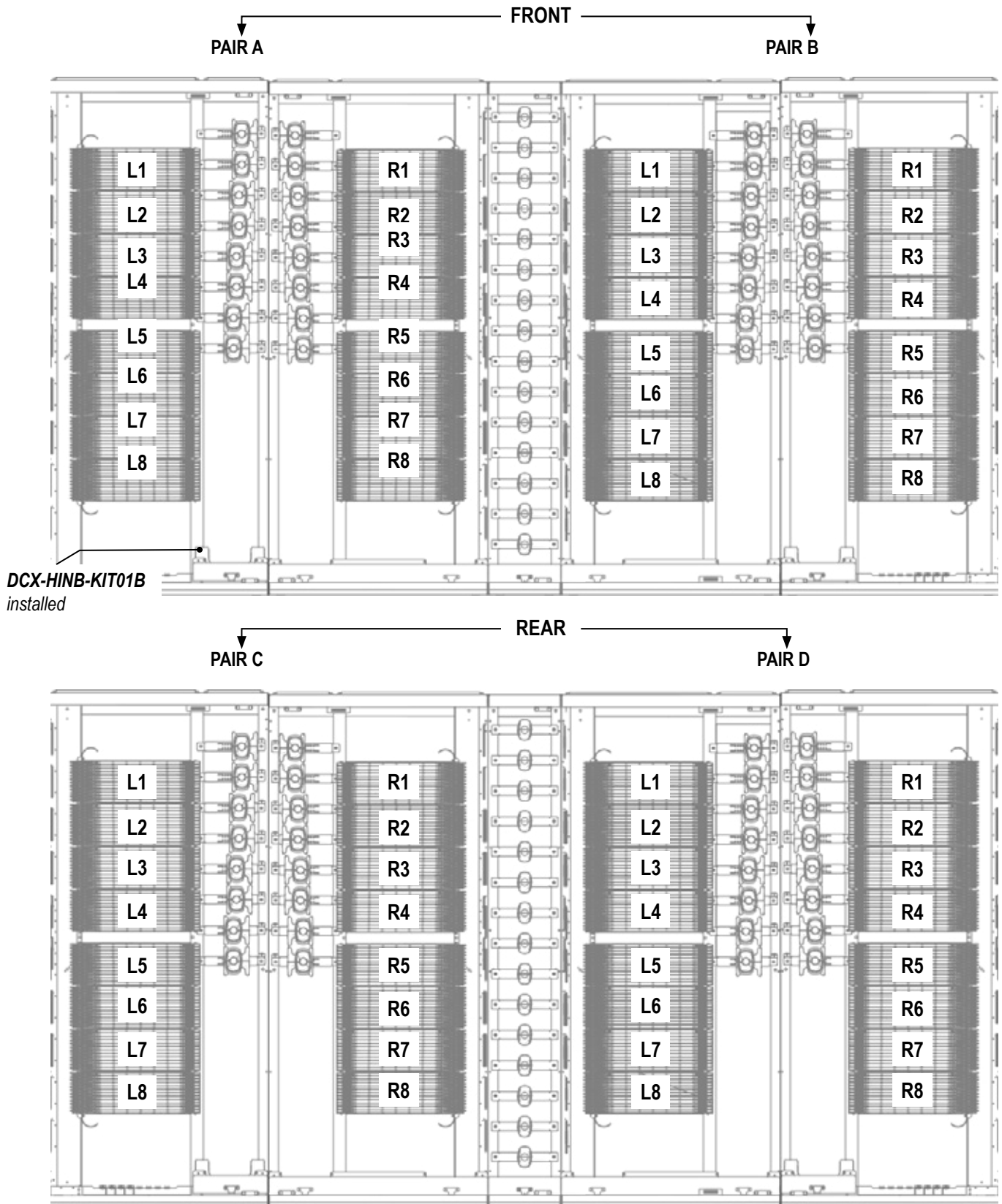



### 3.4.C. INNER-CHANNEL & BACK-TO-BACK FIBER MANAGEMENT (CONTINUED)

2. Once the last Tray (of the selected Housing) is loaded, set the Tray on its closed position and place the **PC** fibers to the associated Spool. Let the **PC** fibers down and place them into:
- the In-Cabinet Channel (if the fibers travel on the same side).
  - the Patch Cord Bridge (if the fibers travel on the rear Cabinets).

When the fibers arrive in the opposite Housing, repeat the first procedure to connect the opposite Patch Cord ends in their respective locations.

#### FRONT CABINETS

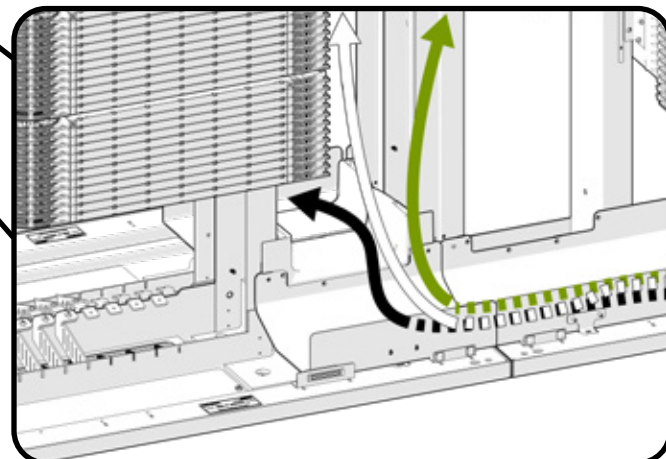
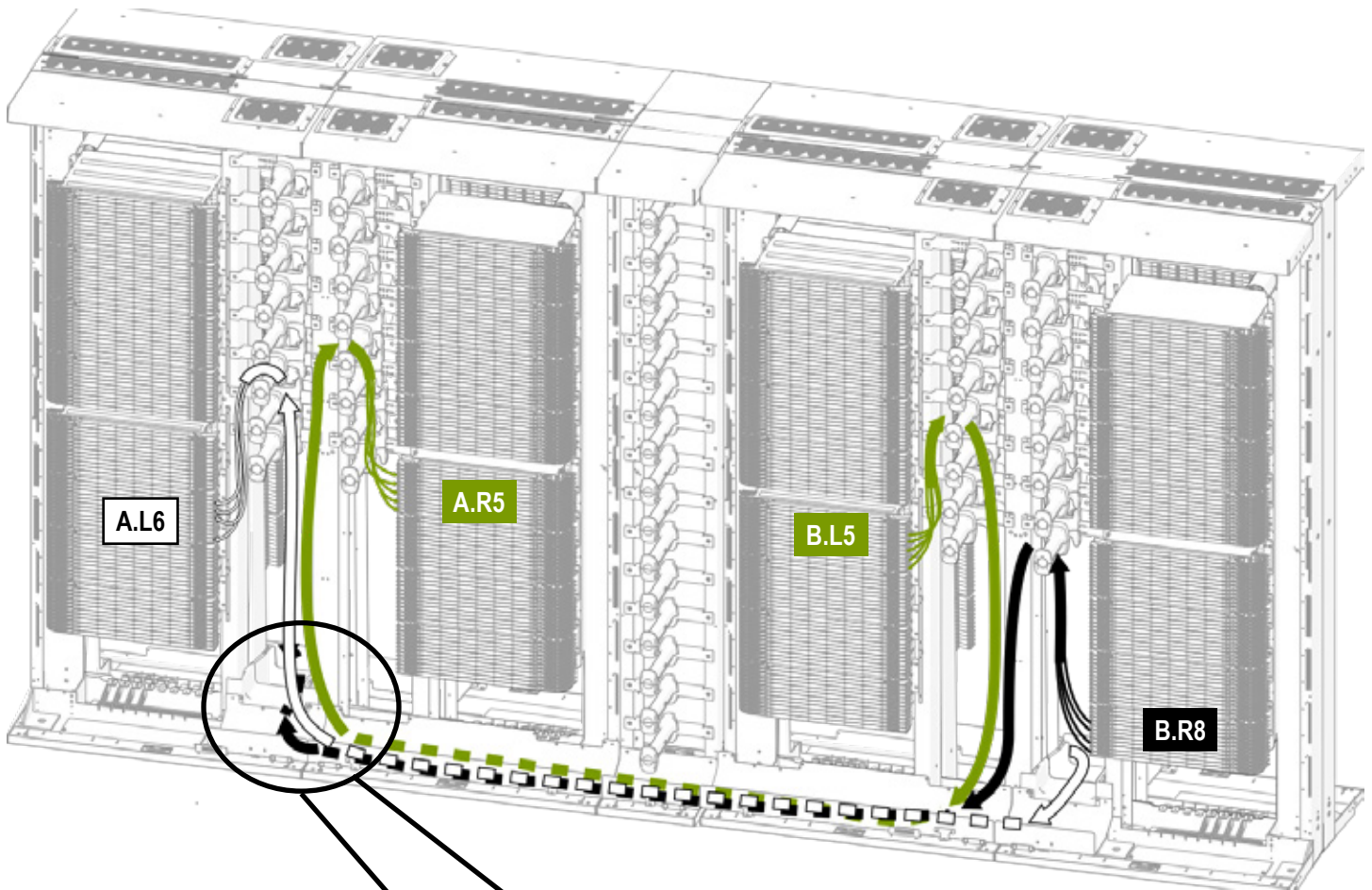

**Connecting paths chosen:**

- **B.L5** → **A.R5**
- **B.R8** → **C.L7**
- **D.L3** → **A.L6**

**Connecting paths chosen:**

- **B.R8** → **C.L7**
- **C.R4** → **D.R4**
- **D.L3** → **A.L6**

**REAR CABINETS**

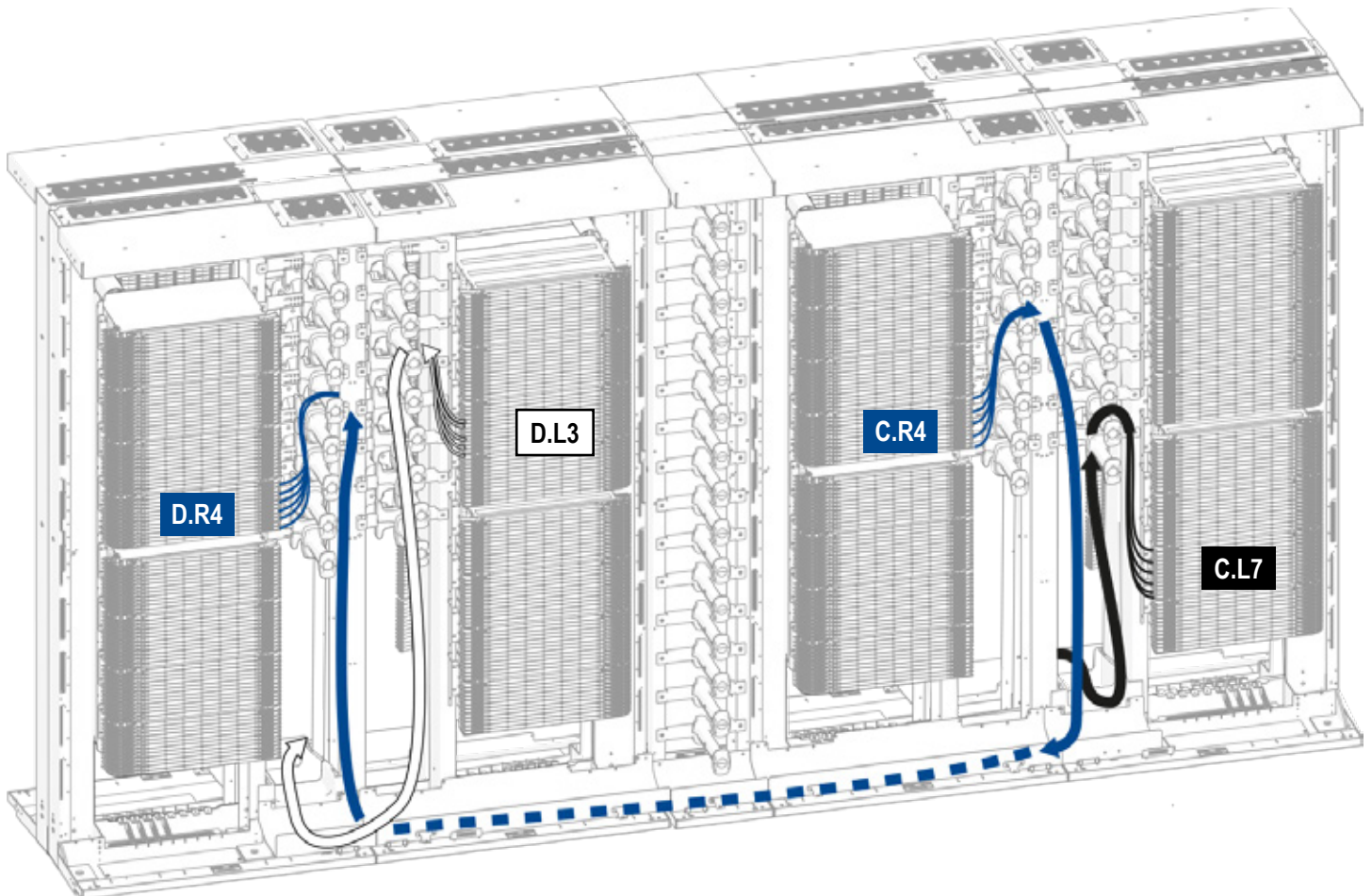

3. To manage the loosen *PC* fibers, take the portion that is near from the *PCSM* and place them on one of the preinstalled Fixed Spools.

**FRONT CABINETS**

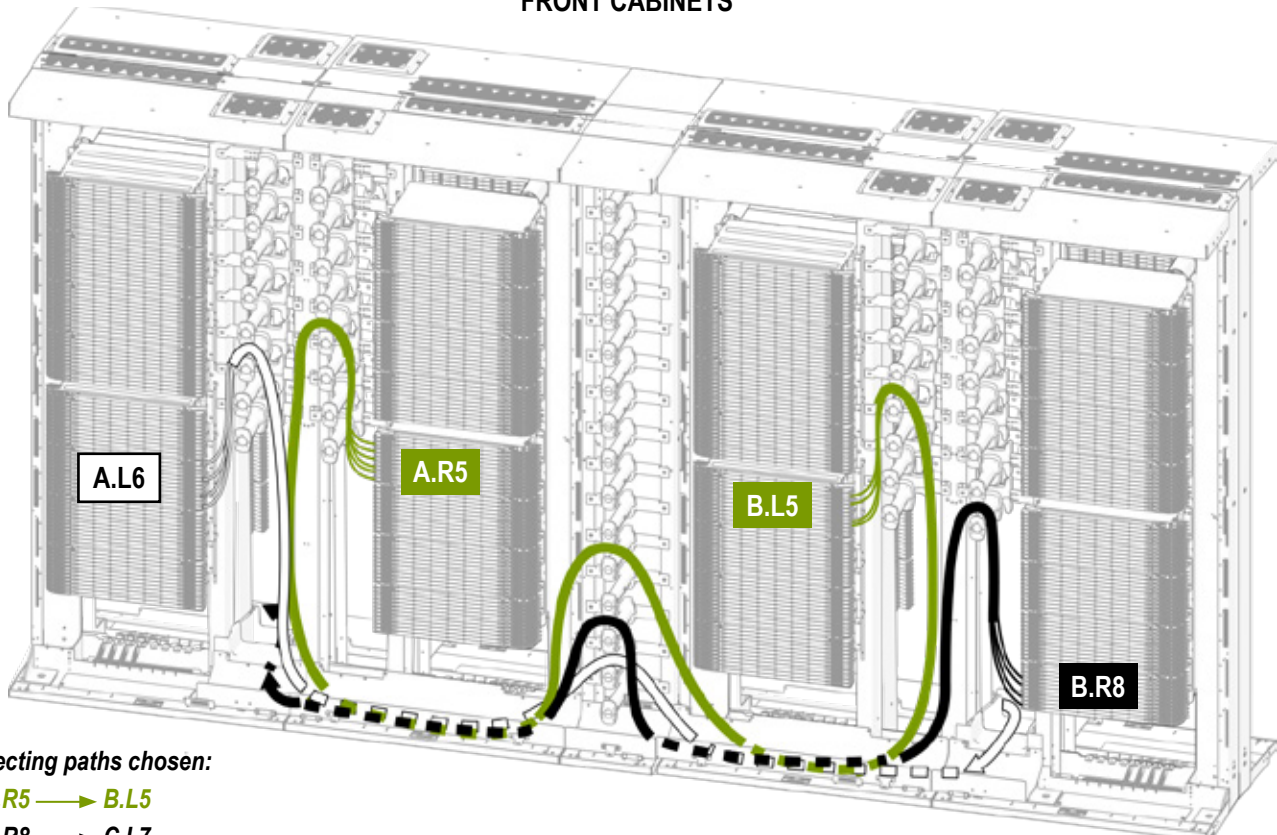

Connecting paths chosen:

- A.R5 → B.L5
- B.R8 → C.L7
- C.R4 → D.R4
- D.L3 → A.L6

**REAR CABINETS**

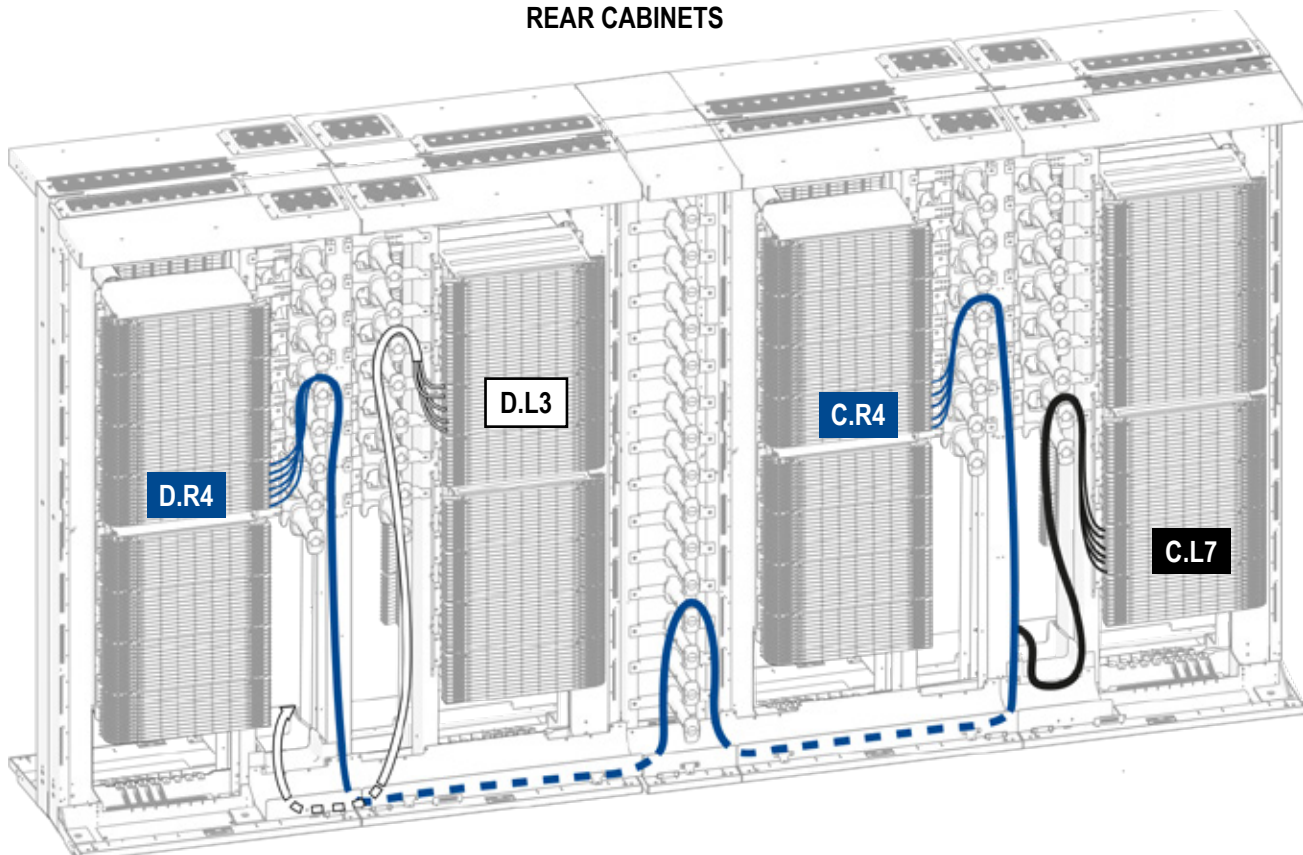

#### 4. Fiber routing limits

This section describes detailed information for:

- The maximum Patch Cord length to route in a pair of Cabinets (recommended).
- The type of Patch Cord cable and the maximum fiber density that each DCX accessory can load.

##### 4.1. Rear-Channel configuration limit

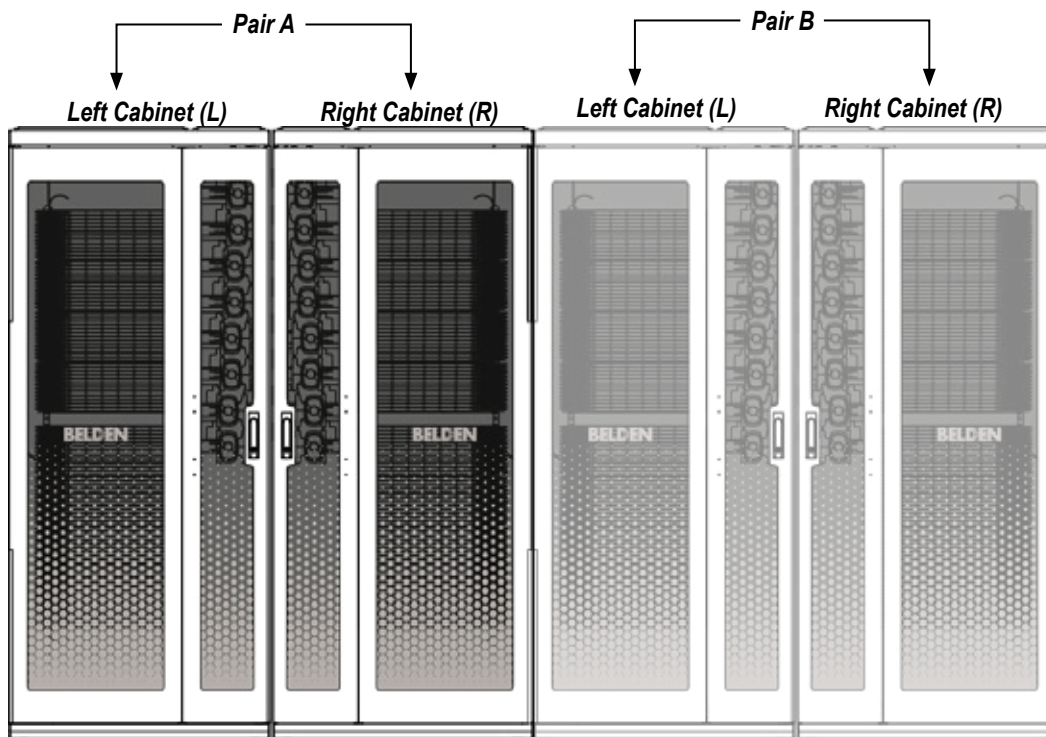

To load completely a Cabinet it takes 4608 fibers.  
By going to another Cabinet if this Patch Cord capacity pass in the same horizontal rear channel the fibers could go up to **six pairs of Cabinets** in the same row.

By doing a Cross-Connection, it is recommended to route and manage the Patch Cord fibers on a maximum of **six pairs** of Cabinets.  
The table below shows the required Patch Cord length to route in each pair.

Pair A		Pair B		Pair C		Pair D		Pair E		Pair F	
L	R	L	R	L	R	L	R	L	R	L	R
← 3.5 m (PC length for 1 pair) →											
← 7.5 m (PC length for 2 pairs) →											
← 9 m (PC length for 3 pairs) →											
← 11 m (PC length for 4 pairs) →											
← 13 m (PC length for 5 pairs) →											
← 14.5 m (PC length for 6 pairs) →											

## 4.2. In-Cabinet Channels configuration limit

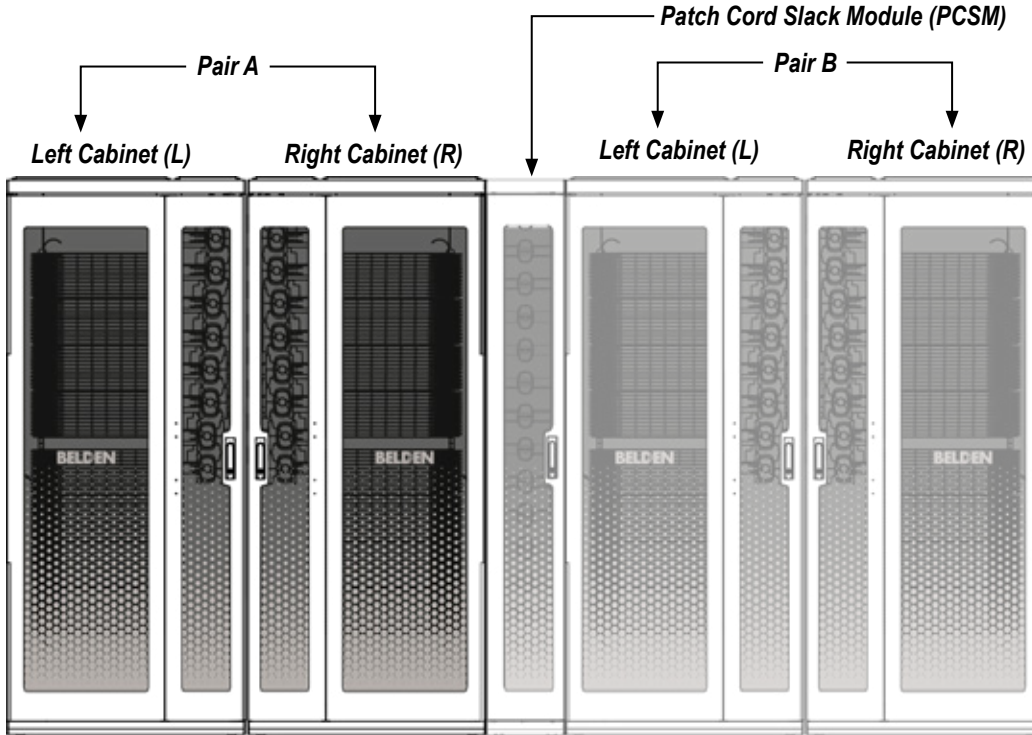

To load completely a Cabinet it takes 4608 fibers.

By going to another Cabinet if this Patch Cord capacity pass in the same horizontal **inner channel** the fibers could go up to **six pairs of Cabinets** in the same row.

By doing a Cross-Connection, it is recommended to route and manage the Patch Cord fibers on a maximum of **six pairs** of Cabinets. Between the limited pairs of Cabinets (six), there are **five Patch Cord Slack Modules** that would manage the slack fibers.

The table below shows the required Patch Cord length to route in each pair.

Pair A		P C S M	Pair B		P C S M	Pair C		P C S M	Pair D		P C S M	Pair E		P C S M	Pair F	
L	R		L	R		L	R		L	R		L	R		L	R
← 3.5 m (PC length for 1 pair) →																
← 7.5 m (PC length for 2 pairs) →																
← 9 m (PC length for 3 pairs) →																
← 11 m (PC length for 4 pairs) →																
← 13 m (PC length for 5 pairs) →																
← 14.5 m (PC length for 6 pairs) →																

### 4.3. Patch Cord type and fiber density per accessory

DCX ACCESORY / CABLE TYPE	1.6 mm	1.6 mm DX	1.6 mm DX-zip	2 mm
Horizontal In-Cabinet Channel	4613 fibers	2307 fibers		1429 fibers
Horizontal Rear Cabinet Channel	4172 fibers	2086 fibers		1335 fibers
Horizontal Patch Cord Bridge	576 fibers	289 fibers		179 fibers
Patch Cord Slack Module	Fibers are counted in the module components			
Patch Cord Slack Spools	576 fibers	289 fibers		179 fibers
Horizontal In-Cabinet Short Channel	4613 fibers	2307 fibers		1429 fibers

#### DCX XConnect Cabinet: Planning/Operation - Installation Guide

PX106863 - EN REV A

This document is also available at our microsite:

[www.belden.com/dcx/products](http://www.belden.com/dcx/products)

For more information about BELDEN Technical support, call:

**1-800-BELDEN-1**

Scan this QR code to  
access more technical  
information of our  
products and get  
constant updates



**BELDEN**